

MURATA PRODUCTS Lineup 2017



2017 MURATA PRODUCTS Lineup

p2

Capacitors

Chip Monolithic Ceramic Capacitors for General Purpose	5
Chip Monolithic Ceramic Capacitors for Automotive	13
Chip Monolithic Ceramic Capacitors for Medical Devices	20
Lead Type Ceramic Capacitors for General Purpose	21
Lead Type Ceramic Capacitors for Automotive	24
High Voltage Ceramic Capacitors / Polymer Aluminum Electrolytic Capacitors	26, 27
Trimmer Capacitors	27



p28

Noise Suppression Products/EMI Suppression Filters

Noise Suppression Filters (Chip Ferrite Bead)	28
Noise Suppression Filters (Feed Through Chip EMI Filters)	30
Noise Suppression Filters (Chip LC Filters)	30
Noise Suppression Filters (Chip EMIFIL®)	30
Noise Suppression Filters (Chip Common Mode Choke Coils/Chip Common Mode Noise Filters)	31
Noise Suppression Filters (Block Type) / ESD Protection Devices	32, 33
Noise Suppression Filters (Lead Type), Others	34



p35

Inductors (Coils)

Inductors for Power Lines, RF Inductors, Lineup	36
---	----



p44

Resistors

High Voltage Resistors	44
------------------------------	----



p45

Timing Devices

Crystal Units	46
Crystal Oscillators	47
Ceramic Resonators CERALOCK®	47



p49

Filters

Ceramic Filters CERAFIL®	49	SAW Filters	
Ceramic Traps	50	for Mobile Communications	51
Ceramic Discriminators	50	Dielectric Filters GIGAFIL®	52
Crystal Filters	51	Chip Multilayer LC Filters	52



p53

RF Components

Antennas	53	Chip Multilayer Diplexers	55
Isolators	54	Microwave Coaxial Connectors	56
Baluns	54	Single Layer Microchip Capacitors	57
Couplers	55	Thin Film Circuit Substrate RUSUB®	59
Chip Multilayer Hybrid Dividers	55		



p60

Sensors

Pyroelectric Infrared Sensors	62	Inclinometers	62
Ultrasonic Sensors	62	Gyro Sensors	62
Rotary Sensors	62	Rotary Position Sensors	62
Magnetic Pattern Recognition Sensors	62	Proximity and Ambient Light Sensors	62
AMR Sensors (Magnetic Sensors)	62	Barometric Pressure Sensors	62
Shock Sensors	62	Temperature Sensors (Thermistors)	62
Accelerometers	62		





Thermistors

NTC Thermistors for Temperature Sensor/Temperature Compensation	64
NTC Thermistors for Inrush Current Suppression	66
PTC Thermistors POSISTOR® for Overheat Sensing	66
PTC Thermistors POSISTOR® for Inrush Current Suppression	67
PTC Thermistors POSISTOR® for Overcurrent Protection	68



Power Devices

DC-DC Converters	69
Micro DC-DC Converters	71
High Voltage Transformers	72
High Voltage Power Supplies	72
Switching Power Supplies	73



Energy Devices

Supercapacitors (EDLC)	74
Small Energy Devices (Lithium Ion Batteries)	75



Sound Components (Buzzer)

SMD Piezoelectric Sounders	76
Pin Type Piezoelectric Sounders	77
Piezoelectric Buzzers	77
Piezoelectric Diaphragms	77



Others

Wireless Communication Modules	78	Ionizer Modules Ionissimo®	81
Variable Capacitors	78	Ozonizer Modules Ionissimo®	82
Micromechanics	79	RFID Devices	83
Ceramic Applied Products	80		



Application Guides

Smart Phones	86	Televisions	114
Wearable Devices	88	Set-top Box	116
Base Stations	90	HEMS	118
G-PON	92	Smartmeter	120
Data Center	93	Thermostat	122
Automotive		Human Detection	124
Powertrain/Safety	94	Air Dispenser	125
HEV/PHEV/EV	96	Blood Pressure Monitor	126
Information/Comfort/Accessory	97	Thermometer	128
Bike/EV Bike	98	Blood Glucose Meter	129
Air Conditioner	100	Diagnostic Imaging Apparatus	130
Refrigerator	102	Security Camera	132
Washing Machine	103	Entrance and Exit Management System	134
Air Purifier	104	Electronic POS	136
Microwave Oven	105	Heavy Duty Vehicles	138
IH Rice Cooker	106	Industrial Automation	140
Vacuum Cleaner	107	3D Printer	142
Tablet Terminators	108	Lighting	144
Notebook Computers	110	Design Support Tool SimSurfing	146
MFP (Multi Function Printer/Product/Peripheral)	112	Index	147

Capacitors

The most comprehensive product lineup in the industry, providing ideal solutions, responding to all possible requirements.

Summary

Using Murata's unique material technology, we offer a variety of capacitors covering a wide range of voltages. Murata also offers technical support that includes design kits and a comprehensive set of software tools to simulate virtually any circuit condition, satisfying the demands of many applications.

Lineup

- Ceramic Capacitors (SMD, lead type, mold type)
- Polymer Aluminum Electrolytic Capacitors
- Ceramic Trimmer Capacitors ● Supercapacitors (EDLC)



<http://www.murata.com/en-global/products/capacitor>

WEB Product Search Engine



1 Search by part number

The applicable capacitors can be searched by alphanumeric characters.



2 Search by specifications

Capacitors can be searched by various specifications, such as the capacitance, rated voltage, and temperature characteristics.



3 Search by features

The applicable capacitors can be searched by the shape, maximum operating temperature, applications, benefits, and mounting.



4 Search in the lineups

Capacitors applicable to the conditions can be searched from the lineup of each series.



5 Cross reference

The Murata part number applicable to the assumed specification can be found using a competitor's part number for chip monolithic ceramic capacitors.



Search results

It is possible to compare characteristics. **<New>**

The number of cases applicable to the current search conditions is always displayed in real time.

Click each search condition button to display the menu. The search results will change in real time with the selected conditions.

Clicking the "Current search conditions" opens a menu, and the current narrowed down conditions can be checked.

The results can be sorted by clicking the ▲ button above the search results items.

Clicking the product name opens the details page, and more detailed information can be acquired.

Detailed specifications sheets can be downloaded without opening the details page.

The icons clearly indicate the status and the features of the product.

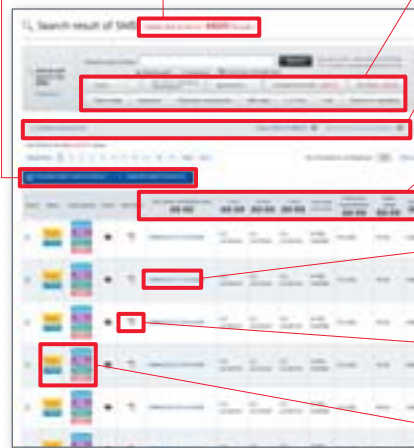

Icons

	For applications that do not require a particular reliability, such as general equipment.
	Infotainment for Automotive Products for entertainment equipment like car navigation, car audio, and body control equipment like wipers and power windows.
	Powertrain/Safety for Automotive Products used for applications (running, turning, stopping, and safety devices) that particularly concern human life, such as in devices for automotive.
	Medical-grade products for Implanted Medical Devices These products are intended for use in implanted medical devices such as cardiac pacemakers, cochlear implants, insulin pumps, and gastric electrostimulators. They are suitable for use in non-critical circuits.*1 *1 Non-critical circuits This term refers to circuits in implanted medical devices that are not directly linked to life support, i.e., circuits that will not directly endanger the life of the patient should the functionality of the device be reduced or halted by failure of the circuit.
	AEC-Q200 compliant product
	Safety Standard Certified Product Products that acquired safety standard certification IEC60384-14 and products based on the Electrical Appliance and Material Safety Law of Japan.
	Low dissipation for high frequency By devising ceramic materials and electrode materials, low dissipation is achieved in frequency bands of VHF, UHF, and microwave or beyond.
	Low inductance This capacitor is designed so that the parasitic inductance component (ESL) that the capacitor has on the high frequency side becomes lower.
	Fail safe product This capacitor is designed to prevent failures as much as possible by short mode.
	Product resistant to deflection cracking This capacitor is designed to prevent failures as much as possible by short mode caused by cracking when there is board deflection.
	Product with solder cracking suppression This capacitor is configured with metal terminals and leads connected to the chip. The metal terminals and leads relieve the stress from expansion and contraction of the solder, to suppress solder cracking.
	Product suitable for acoustic noise reduction and low distortion This product suppresses acoustic noise, which occurs when a ceramic capacitor is used, by devising the materials and configuration.
	No DC bias characteristics Polymer capacitor is no capacitance change with DC bias due to aluminum oxidized film for dielectric.
	Low-inductance product suitable for noise suppression. This product has extremely low ESL and is suitable for suppression of noise, including high frequencies. This product can also be used as a low-ESL, high-performance bypass capacitor.
	Product for bonding Since gold is used for the external electrodes, the capacitor can be mounted by die bonding/wire bonding.
	Limited to Conductive Glue Mounting Since silver palladium is used for the external electrodes, the capacitor can be mounted by conductive adhesive.

Capacitors

Product Lineup

			AEC-Q200	Safety standard	High Q	Low ESL	Anti-noise	Fail safe	Deflecting crack	Soldering crack	Effective Cap	EMI FIL®	Other
General	GRM	P5											
	GRM	P7											For LED backlight only
	GA2	P7											
	GA3	P8											
	GJM	P8											
	GMA	P8											Wire bondable
	GMD	P9											Wire bondable
	GQM	P9											
	GR3	P9											
	GR4	P10											For communication / information devices
	GR7	P10											Limited to camera flashes
	GRJ	P10											
	KR3	P11											
	KRM	P11											
	LLL	P12											
	LLR	P12											
	LLA	P12											
	LLM	P13											
	NFM	P13											
	DE1	P21											
	DE2	P21											
	DEJ	P21											
	DHR	P21											
	RDE	P22											
	DHK	P26											
	DHS	P26											
	ECAS	P27											
Info-tainment	GRT	P13											
Power-train	GCM	P15											
	GC3	P16											
	GCD	P16											
	GCE	P16											
	GCG	P17											Limited to conductive glue mounting
	G CJ	P18											
	KC3	P19											
	KCA	P19											
	KCM	P19											
	NFM	P19											
	DE6	P24											
	RCE	P24											
	RH	P25											
	Medical Device	GCH	P20										

Chip Monolithic Ceramic Capacitors For General Purpose

For General Purpose

Temperature Compensating Type



GRM

General

Series	LXW (mm) <Size Code (inch)>	Rated Voltage (Vdc)	Capacitance Range (F)											
			0.1p	1p	10p	100p	1000p	10000p	0.1μ	1μ	10μ	100μ	1000μ	
GRM02	0.4X0.2 <01005>	50	0.20pF				100pF							
		25				120pF	220pF							
		16				120pF	220pF							
GRM03	0.6X0.3 <0201>	100	0.10pF		15pF									
		50	0.10pF			220pF								
		25				270pF	1000pF							
GRM15	1.0X0.5 <0402>	100	0.10pF			100pF								
		50	0.10pF				1000pF							
		10					1200pF	4700pF						
GRM18	1.6X0.8 <0603>	100	0.50pF				1500pF							
		50	0.50pF					10000pF						
		10						5600pF	22000pF					
GRM21	2.0X1.25 <0805>	250			10pF			5600pF						
		200			10pF			5600pF						
		100				100pF			3300pF					
		50					1200pF		47000pF					
		10							56000pF	0.10μF				
GRM31	3.2X1.6 <1206>	2k			10pF		68pF							
		1k			10pF			1000pF						
		630			10pF			4700pF						
		500			10pF			4700pF						
		250					390pF		22000pF					
		200						2700pF	10000pF					
		100						1800pF		0.10μF				
		50							12000pF	0.10μF				
		25								0.12μF				
		16								0.12μF				
GRM32	3.2X2.5 <1210>	2k				82pF		220pF						
		1k					1200pF	2200pF						
		630					1200pF	10000pF						
		500					1200pF	10000pF						
		250							27000pF	47000pF				
GRM42	4.5X2.0 <1808>	3.15k			10pF		100pF							
GRM43	4.5X3.2 <1812>	1k						2700pF	4700pF					
		630						12000pF	22000pF					
		500						12000pF	22000pF					
GRM55	5.7X5.0 <2220>	1k						5600pF	10000pF					
		630							27000pF	47000pF				
		500							27000pF	47000pF				

Continued on the following page. ↗

Capacitors

High Dielectric Constant Type



GRM

General

Series	LxW (mm) <Size Code (inch)>	Rated Voltage (Vdc)	Capacitance Range (F)										
			0.1p	1p	10p	100p	1000p	10000p	0.1μ	1μ	10μ	100μ	1000μ
GRM02	0.4X0.2 <01005>	16				100pF	1000pF						
		10				100pF	10000pF						
		6.3					1000pF	0.10μF					
		4						15000pF	0.10μF				
		2.5								0.10μF			
GRM03	0.6X0.3 <0201>	50				100pF	1500pF						
		35							0.10μF				
		25				100pF			0.10μF				
		16					2200pF	0.10μF					
		10					4700pF	0.22μF					
		6.3					4700pF	0.22μF					
		4								0.22μF			
GRM15	1.0X0.5 <0402>	100				220pF	4700pF						
		50				220pF			0.47μF				
		35							0.22μF	1.0μF			
		25					2200pF	2.2μF					
		16					3300pF	2.2μF					
		10					15000pF	4.7μF					
		6.3							0.10μF	4.7μF			
		4							0.10μF	10μF			
GRM18	1.6X0.8 <0603>	250				220pF	2200pF						
		200				220pF	2200pF						
		50							0.47μF	2.2μF			
		35							2.2μF	4.7μF			
		25							1.0μF	10μF			
		16							1.0μF	10μF			
		10							2.2μF	10μF			
		6.3								4.7μF	22μF		
GRM21	2.0X1.25 <0805>	500				1000pF	10000pF						
		250				1000pF	22000pF						
		200				1000pF	22000pF						
		50							1.0μF	4.7μF			
		35							2.2μF	10μF			
		25							1.0μF	22μF			
		16							1.0μF	22μF			
		10							2.2μF	47μF			
		6.3								10μF	100μF		
		4								10μF	100μF		
GRM31	3.2X1.6 <1206>	1k				470pF	10000pF						
		630				1000pF	22000pF						
		500					15000pF	47000pF					
		250					15000pF	0.10μF					
		200					15000pF	0.10μF					
		100							1.0μF	2.2μF			
		50							1.0μF	10μF			
		35								10μF			
		25								4.7μF	22μF		
		16								4.7μF	47μF		
		10									22μF	47μF	

Continued on the following page. ↗

Series	LXW (mm) <Size Code (inch)>	Rated Voltage (Vdc)	Capacitance Range (F)											
			0.1p	1p	10p	100p	1000p	10000p	0.1μ	1μ	10μ	100μ	1000μ	
GRM31	3.2X1.6 <1206>	6.3										22μF	150μF	
		4										47μF	220μF	
		2.5										150μF	220μF	
GRM32	3.2X2.5 <1210>	1k					6800pF	22000pF						
		630					22000pF	47000pF						
		500					68000pF	0.10μF						
		250					68000pF	0.22μF						
		200					68000pF	0.22μF						
		100							1.0μF	4.7μF				
		80								4.7μF				
		63									10μF			
		50									4.7μF	10μF		
		35										10μF		
		25										10μF	22μF	
		16										22μF	47μF	
		10										47μF	100μF	
		6.3										47μF	100μF	
4											100μF			
GRM43	4.5X3.2 <1812>	1k					33000pF	47000pF						
		630					68000pF	0.10μF						
		500							0.15μF	0.22μF				
		250							0.15μF	0.47μF				
		200							0.15μF	0.47μF				
GRM55	5.7X5.0 <2220>	1k					68000pF	0.10μF						
		630							0.15μF	0.22μF				
		500							0.33μF	0.47μF				
		250							0.33μF	1.0μF				
		200							0.33μF	1.0μF				

For LCD Backlight Inverter Circuit Only



General

GRM

Series	LXW (mm) <Size Code (inch)>	Rated Voltage (Vdc)	Capacitance Range (F)											
			0.1p	1p	10p	100p	1000p	10000p	0.1μ	1μ	10μ	100μ	1000μ	
GRM42	4.5X2.0 <1808>	3.15k				5.0pF	47pF							

Safety Standard Certified

■ The Electrical Appliance and Material Safety Law of Japan

General



GA2

Series	LXW (mm) <Size Code (inch)>	Rated Voltage (V)	Capacitance Range (F)											
			0.1p	1p	10p	100p	1000p	10000p	0.1μ	1μ	10μ	100μ	1000μ	
GA242	4.5X2.0 <1808>	AC250 (r.m.s.)					470pF	1000pF						
GA243	4.5X3.2 <1812>	AC250 (r.m.s.)					2200pF	47000pF						
GA255	5.7X5.0 <2220>	AC250 (r.m.s.)								0.10μF				

Continued on the following page. ↗

Capacitors

Type GF (IEC60384-14 Y2, X1/Y2 Class)



GA3

General

Safety standard

Series	LXW (mm) <Size Code (inch)>	Rated Voltage (V)	Capacitance Range (F)												
			0.1p	1p	10p	100p	1000p	10000p	0.1μ	1μ	10μ	100μ	1000μ		
GA342	4.5X2.0 <1808>	AC250 (r.m.s.)			10pF										
GA352	5.7X2.8 <2211>	AC250 (r.m.s.)				100pF									
GA355	5.7X5.0 <2220>	AC250 (r.m.s.)						1800pF							

Type GD (UL60950-1 Certified Product)



GA3

General

Safety standard

Series	LXW (mm) <Size Code (inch)>	Rated Voltage (V)	Capacitance Range (F)												
			0.1p	1p	10p	100p	1000p	10000p	0.1μ	1μ	10μ	100μ	1000μ		
GA342	4.5X2.0 <1808>	AC250 (r.m.s.)			10pF										
GA343	4.5X3.2 <1812>	AC250 (r.m.s.)						1800pF							

Type GB (IEC60384-14 X2 Class)



GA3

General

Safety standard

Series	LXW (mm) <Size Code (inch)>	Rated Voltage (V)	Capacitance Range (F)												
			0.1p	1p	10p	100p	1000p	10000p	0.1μ	1μ	10μ	100μ	1000μ		
GA355	5.7X5.0 <2220>	AC250 (r.m.s.)							10000pF						

High Q Type for High Frequency



GJM

General

High Q

Series	LXW (mm) <Size Code (inch)>	Rated Voltage (Vdc)	Capacitance Range (F)												
			0.1p	1p	10p	100p	1000p	10000p	0.1μ	1μ	10μ	100μ	1000μ		
GJM02	0.4X0.2 <01005>	25	0.20pF												
GJM03	0.6X0.3 <0201>	50	0.20pF			3.9pF									
		25			1.0pF										
GJM15	1.0X0.5 <0402>	50	0.10pF												

Top & Bottom Electrode Type for Bonding



GMA

General

Bonding

Series	LXW (mm) <Size Code (inch)>	Rated Voltage (Vdc)	Capacitance Range (F)												
			0.1p	1p	10p	100p	1000p	10000p	0.1μ	1μ	10μ	100μ	1000μ		
GMA0D	0.38X0.38 <015015>	10					1000pF								
GMA05	0.5X0.5 <0202>	100				100pF			1000pF						
		25						1500pF							
		10							6800pF						
		6.3												0.10μF	
GMA08	0.8X0.8 <0303>	100					1500pF								
		25							10000pF						
		10								33000pF					
		6.3												0.47μF	

Product for Bonding/AuSn Soldering



GMD



Series	LXW (mm) <Size Code (inch)>	Rated Voltage (Vdc)	Capacitance Range (F)											
			0.1p	1p	10p	100p	1000p	10000p	0.1μ	1μ	10μ	100μ	1000μ	
GMD03	0.6X0.3 <0201>	25				100pF		1500pF						
		16					1800pF		3300pF					
		10						3900pF		10000pF				
		6.3								56000pF		0.10μF		
GMD15	1.0X0.5 <0402>	50				220pF		4700pF						
		25						5600pF		47000pF				
		16								56000pF		0.10μF		
		10									0.12μF		0.47μF	

High Q Type for High Frequency and High Power



GQM



Series	LXW (mm) <Size Code (inch)>	Rated Voltage (Vdc)	Capacitance Range (F)											
			0.1p	1p	10p	100p	1000p	10000p	0.1μ	1μ	10μ	100μ	1000μ	
GQM15	1.0X0.5 <0402>	200	0.10pF				33pF							
		100				36pF		47pF						
GQM18	1.6X0.8 <0603>	250		1.0pF			47pF							
		100		1.0pF		6.8pF								
		50			7.0pF		100pF							
GQM21	2.0X1.25 <0805>	500		1.0pF			22pF							
		250		1.0pF			100pF							
		100		1.0pF			18pF							
		50				20pF		100pF						
GQM22	2.8X2.8 <1111>	500		1.0pF			100pF							

High Effective Capacitance & High Ripple Resistance



GR3



Series	LXW (mm) <Size Code (inch)>	Rated Voltage (Vdc)	Capacitance Range (F)											
			0.1p	1p	10p	100p	1000p	10000p	0.1μ	1μ	10μ	100μ	1000μ	
GR321	2.0X1.25 <0805>	250						10000pF		22000pF				
GR331	3.2X1.6 <1206>	630						10000pF		15000pF				
		450						10000pF		47000pF				
		250								33000pF		68000pF		
GR332	3.2X2.5 <1210>	630								22000pF		47000pF		
		450									68000pF		0.10μF	
		250										0.10μF		0.15μF
GR343	4.5X3.2 <1812>	630										68000pF		
		450											0.15μF	
		250											0.22μF	0.33μF
GR355	5.7X5.0 <2220>	630										0.10μF		0.22μF
		450											0.22μF	0.47μF
		250											0.47μF	1.0μF

Capacitors

For Ethernet LAN & Primary-secondary Coupling of DC-DC Converters



GR4

General

Series	LXW (mm) <Size Code (inch)>	Rated Voltage (Vdc)	Capacitance Range (F)											
			0.1p	1p	10p	100p	1000p	10000p	0.1μ	1μ	10μ	100μ	1000μ	
GR442	4.5X2.0 <1808>	2k				100pF	1500pF							
GR443	4.5X3.2 <1812>	2k					1800pF	4700pF						
GR455	5.7X5.0 <2220>	2k							10000pF					

For Camera Flash Units Only



GR7

General

Series	LXW (mm) <Size Code (inch)>	Rated Voltage (Vdc)	Capacitance Range (F)											
			0.1p	1p	10p	100p	1000p	10000p	0.1μ	1μ	10μ	100μ	1000μ	
GR721	2.0X1.25 <0805>	350						10000pF	27000pF					
GR731	3.2X1.6 <1206>	350						10000pF	47000pF					

Resin External Electrode Type



GRJ

General

Deflecting crack

Series	LXW (mm) <Size Code (inch)>	Rated Voltage (Vdc)	Capacitance Range (F)										
			0.1p	1p	10p	100p	1000p	10000p	0.1μ	1μ	10μ	100μ	1000μ
GRJ18	1.6X0.8 <0603>	100					1000pF	0.10μF					
		50					1000pF	0.22μF					
		35							1.0μF				
		25						47000pF	1.0μF				
		16							0.47μF				
		6.3								2.2μF	4.7μF		
GRJ21	2.0X1.25 <0805>	250					1000pF	22000pF					
		100				220pF	1.0μF						
		50				470pF	1.0μF						
		25						1.0μF	2.2μF				
		16								4.7μF			
		10									10μF		
GRJ31	3.2X1.6 <1206>	1k				470pF	10000pF						
		630				1000pF	22000pF						
		250					15000pF	0.10μF					
		100						0.10μF	1.0μF				
		50						0.10μF	4.7μF				
		25							2.2μF	10μF			
		16							2.2μF	10μF			
		10								10μF	22μF		
		6.3									22μF		
		10										22μF	47μF
GRJ32	3.2X2.5 <1210>	1k					6800pF	22000pF					
		630					22000pF	47000pF					
		250						68000pF	0.22μF				
		100							2.2μF	4.7μF			
		50								4.7μF	10μF		
		25									10μF		
		16										22μF	
		10											22μF

Continued on the following page. ↗

Series	LXW (mm) <Size Code (inch)>	Rated Voltage (Vdc)	Capacitance Range (F)											
			0.1p	1p	10p	100p	1000p	10000p	0.1μ	1μ	10μ	100μ	1000μ	
GRJ32	3.2X2.5 <1210>	6.3											47μF	
GRJ43	4.5X3.2 <1812>	1k							33000pF	47000pF				
		630							68000pF	0.10μF				
		250								0.15μF	0.47μF			
GRJ55	5.7X5.0 <2220>	1k							68000pF	0.10μF				
		630								0.15μF	0.22μF			
		250								0.33μF	1.0μF			

Metal Terminal Type

High Effective Capacitance & High Ripple Resistance



KR3

- General
- Deflecting crack
- Soldering crack
- Anti-noise

Series	LXW (mm)	Rated Voltage (Vdc)	Capacitance Range (F)											
			0.1p	1p	10p	100p	1000p	10000p	0.1μ	1μ	10μ	100μ	1000μ	
KR355	6.1X5.3	630								0.10μF	0.56μF			
		450								0.22μF	1.2μF			
		250								0.47μF	2.2μF			

High Effective Capacitance



KRM

- General
- Deflecting crack
- Soldering crack
- Anti-noise

Series	LXW (mm)	Rated Voltage (Vdc)	Capacitance Range (F)											
			0.1p	1p	10p	100p	1000p	10000p	0.1μ	1μ	10μ	100μ	1000μ	
KRM21	2.2X1.25	25									10μF	22μF		
		16										10μF		
KRM31	3.5X1.7	100									1.0μF			
		50									4.7μF			
		35										10μF		
		25										10μF		
	3.6X1.7	50									2.2μF			
KRM55	6.1X5.3	100									2.2μF			
		1k							68000pF	0.22μF				
		630								0.15μF	0.47μF			
		250									0.68μF	2.2μF		
		100										4.7μF	22μF	
		63										4.7μF	22μF	
		50										4.7μF	33μF	
		35										10μF	47μF	
25										15μF	68μF			

Capacitors

Low ESL Type

LW Reversed Type



LLL

General

Low ESL

Series	LXW (mm) <Size Code (inch)>	Rated Voltage (Vdc)	Capacitance Range (F)											
			0.1p	1p	10p	100p	1000p	10000p	0.1μ	1μ	10μ	100μ	1000μ	
LLL15	0.5X1.0 <0204>	6.3							0.10μF	0.22μF				
		4							0.47μF	1.0μF				
LLL1U	0.6X1.0 <02404>	4									4.3μF			
LLL18	0.8X1.6 <0306>	50					2200pF	4700pF						
		25					10000pF	22000pF						
		16					22000pF	47000pF						
		10							0.10μF	0.22μF				
		4								0.22μF	2.2μF			
LLL21	1.25X2.0 <0508>	50					10000pF	22000pF						
		25					22000pF	0.10μF						
		16					47000pF	0.22μF						
		10							0.22μF	1.0μF				
		6.3								0.47μF				
LLL31	1.6X3.2 <0612>	50					10000pF	0.10μF						
		25					47000pF	0.47μF						
		16							0.22μF	1.0μF				
		10							0.47μF	2.2μF				
		6.3								2.2μF	10μF			

Controlled ESR Type



LLR

General

Low ESL

Series	LXW (mm) <Size Code (inch)>	Rated Voltage (Vdc)	ESR (mΩ)				Capacitance
			100	220	470	1000	
LLR18	0.8X1.6 <0306>	4					1.0μF

8 Terminal Type



LLA

General

Low ESL

Series	LXW (mm) <Size Code (inch)>	Rated Voltage (Vdc)	Capacitance Range (F)											
			0.1p	1p	10p	100p	1000p	10000p	0.1μ	1μ	10μ	100μ	1000μ	
LLA18	1.6X0.8 <0603>	4							0.10μF	2.2μF				
LLA21	2.0X1.25 <0805>	25					10000pF	47000pF						
		16					47000pF	0.22μF						
		10							0.22μF	0.47μF				
		6.3							0.47μF	1.0μF				
LLA31	3.2X1.6 <1206>	4							1.0μF	4.7μF				
		16							0.22μF	1.0μF				
		10							0.47μF	2.2μF				
		6.3							1.0μF	2.2μF				

Continued on the following page. ↗

10 Terminal Type



LLM

General Low ESL

Series	LXW (mm) <Size Code (inch)>	Rated Voltage (Vdc)	Capacitance Range (F)											
			0.1p	1p	10p	100p	1000p	10000p	0.1μ	1μ	10μ	100μ	1000μ	
LLM21	2.0X1.25 <0805>	6.3								0.22μF	0.47μF			
		4										1.0μF		
LLM31	3.2X1.6 <1206>	16								0.10μF	0.22μF			
		10										0.47μF		
		6.3											2.2μF	

3 Terminal Low ESL Type



NFM

General Low ESL EMI FIL®

Series	LXW (mm) <Size Code (inch)>	Rated Voltage (Vdc)	Capacitance Range (F)											
			0.1p	1p	10p	100p	1000p	10000p	0.1μ	1μ	10μ	100μ	1000μ	
NFM15	1.0X0.5 <0402>	16					2200pF			47000pF				
		10					2200pF			0.22μF				
		6.3							0.10μF	0.47μF				
		4								0.47μF	1.0μF			
		2.5										4.3μF	9.1μF	
NFM18	1.6X0.8 <0603>	16				100pF			0.10μF					
		10									2.2μF			
		6.3							0.22μF	2.2μF				
NFM21	2.0X1.25 <0805>	50				220pF			22000pF					
		25							0.10μF					
		16							0.22μF	1.0μF				
		10								1.0μF	4.7μF			
		6.3									2.2μF	10μF		
NFM3D	3.2X1.25 <1205>	50				220pF			22000pF					
NFM31	3.2X1.6 <1206>	100						10000pF	0.10μF					
		50						10000pF	0.10μF					
		6.3										27μF		
NFM41	4.5X1.6 <1806>	100				470pF			22000pF					
		50							0.20μF	1.5μF				
		25									1.5μF			

Chip Monolithic Ceramic Capacitors For Automotive

Meet AEC-Q200 for Infotainment

Temperature Compensating Type



GRT

Info-tainment AEC-Q200

Series	LXW (mm) <Size Code (inch)>	Rated Voltage (Vdc)	Capacitance Range (F)											
			0.1p	1p	10p	100p	1000p	10000p	0.1μ	1μ	10μ	100μ	1000μ	
GRT15	1.0X0.5 <0402>	100		1.0pF		100pF								
		50		1.0pF			1000pF							

Continued on the following page. ↗

Capacitors

Series	LxW (mm) <Size Code (inch)>	Rated Voltage (Vdc)	Capacitance Range (F)											
			0.1p	1p	10p	100p	1000p	10000p	0.1μ	1μ	10μ	100μ	1000μ	
GRT15	1.0X0.5 <0402>	25			10pF			1000pF						
GRT18	1.6X0.8 <0603>	100		1.0pF			1500pF							
		50		1.0pF			10000pF							
		25				560pF		10000pF						
GRT21	2.0X1.25 <0805>	50					18000pF		22000pF					
GRT31	3.2X1.6 <1206>	50						56000pF		0.10μF				
		25								0.10μF	0.12μF			
		16									0.12μF			

High Dielectric Constant Type



GRT



Series	LxW (mm) <Size Code (inch)>	Rated Voltage (Vdc)	Capacitance Range (F)											
			0.1p	1p	10p	100p	1000p	10000p	0.1μ	1μ	10μ	100μ	1000μ	
GRT03	0.6X0.3 <0201>	35									0.10μF			
		25				100pF					0.10μF			
		16							10000pF		0.10μF			
		10						2200pF		0.22μF				
		6.3						2200pF			1.0μF			
		4									0.22μF	1.0μF		
GRT15	1.0X0.5 <0402>	50				220pF				0.10μF				
		35								0.22μF	1.0μF			
		25							10000pF		2.2μF			
		16							10000pF		2.2μF			
		10								0.22μF	2.2μF			
		6.3							22000pF		4.7μF			
		4									1.0μF	4.7μF		
		2.5										10μF		
GRT18	1.6X0.8 <0603>	50								1.0μF	2.2μF			
		35								1.0μF	4.7μF			
		25								1.0μF	10μF			
		16								1.0μF	10μF			
		10								1.0μF	10μF			
		6.3								1.0μF	22μF			
		4								1.0μF	22μF			
		2.5										22μF		
GRT21	2.0X1.25 <0805>	50								1.0μF	4.7μF			
		35								2.2μF	4.7μF			
		25								2.2μF	22μF			
		16								2.2μF	22μF			
		10								4.7μF	22μF			
		6.3								4.7μF	47μF			
		4										47μF		
													47μF	
GRT31	3.2X1.6 <1206>	50								2.2μF	10μF			
		35									10μF			
		25									10μF	22μF		
		16										22μF		
		10									22μF	47μF		
		6.3									22μF	47μF		
		4									22μF	47μF		
												47μF		
GRT32	3.2X2.5 <1210>	50									4.7μF			
		25										10μF		
		16											47μF	
		10											47μF	
		6.3											33μF	100μF

For Automotive (General Purpose)

Temperature Compensating Type



GCM



Series	LXW (mm) <Size Code (inch)>	Rated Voltage (Vdc)	Capacitance Range (F)														
			0.1p	1p	10p	100p	1000p	10000p	0.1μ	1μ	10μ	100μ	1000μ				
GCM15	1.0X0.5 <0402>	50		1.0pF					1000pF								
GCM18	1.6X0.8 <0603>	100		1.0pF						10000pF							
		50		1.0pF						10000pF							
GCM21	2.0X1.25 <0805>	250			10pF					5600pF							
		100				100pF			3300pF								
		80							15000pF	22000pF							
		63							15000pF	22000pF							
		50							4700pF	22000pF							
GCM31	3.2X1.6 <1206>	1k			10pF				1000pF								
		630			10pF				4700pF								
		250			10pF				15000pF								
		100							3900pF	10000pF							
GCM32	3.2X2.5 <1210>	1k						1200pF	2200pF								
		630						1200pF	10000pF								
GCM43	4.5X3.2 <1812>	1k						2700pF	4700pF								
		630						12000pF	22000pF								
GCM55	5.7X5.0 <2220>	1k						5600pF	10000pF								
		630						27000pF	47000pF								

High Dielectric Constant Type



GCM



Series	LXW (mm) <Size Code (inch)>	Rated Voltage (Vdc)	Capacitance Range (F)													
			0.1p	1p	10p	100p	1000p	10000p	0.1μ	1μ	10μ	100μ	1000μ			
GCM03	0.6X0.3 <0201>	25					100pF			1500pF						
		16					330pF			3300pF						
		10							4700pF	10000pF						
GCM15	1.0X0.5 <0402>	100					220pF			4700pF						
		50					220pF			0.10μF						
		25							10000pF	0.10μF						
		16							33000pF	0.22μF						
		10								0.47μF	1.0μF					
GCM18	1.6X0.8 <0603>	100					1000pF			22000pF						
		50								0.22μF						
		25								0.22μF	1.0μF					
		16								0.33μF	1.0μF					
		6.3									2.2μF					
GCM21	2.0X1.25 <0805>	100						6800pF			1.0μF					
		50								0.22μF	1.0μF					
		35								0.68μF	4.7μF					
		25								0.15μF	4.7μF					
		16								0.68μF	4.7μF					
		10									2.2μF	10μF				
		6.3										10μF				
GCM31	3.2X1.6 <1206>	100								0.22μF	2.2μF					
		50								0.33μF	4.7μF					
		25									4.7μF	10μF				



Continued on the following page. ↗

Capacitors

Series	LXW (mm) <Size Code (inch)>	Rated Voltage (Vdc)	Capacitance Range (F)													
			0.1p	1p	10p	100p	1000p	10000p	0.1μ	1μ	10μ	100μ	1000μ			
GCM31	3.2X1.6 <1206>	16									4.7μF	10μF				
		10										10μF	22μF			
		6.3											22μF			
GCM32	3.2X2.5 <1210>	100									4.7μF					
		50								4.7μF	10μF					
		35									10μF					
		25									10μF					
		16										10μF	22μF			
		10											22μF			
		6.3												47μF		

High Effective Capacitance & High Ripple Resistance







Series	LXW (mm) <Size Code (inch)>	Rated Voltage (Vdc)	Capacitance Range (F)											
			0.1p	1p	10p	100p	1000p	10000p	0.1μ	1μ	10μ	100μ	1000μ	
GC321	2.0X1.25 <0805>	250					10000pF	22000pF						
GC331	3.2X1.6 <1206>	630					10000pF	15000pF						
		450					10000pF	47000pF						
GC332	3.2X2.5 <1210>	250					33000pF	68000pF						
		630					22000pF	47000pF						
GC343	4.5X3.2 <1812>	450					68000pF	0.10μF						
		250					0.10μF	0.15μF						
		630					68000pF							
GC355	5.7X5.0 <2220>	450					0.22μF	0.33μF						
		250					0.10μF	0.22μF						
		630					0.22μF	0.47μF						
		250					0.47μF	1.0μF						

Specially Designed Product to Reduce Shorts







Series	LXW (mm) <Size Code (inch)>	Rated Voltage (Vdc)	Capacitance Range (F)											
			0.1p	1p	10p	100p	1000p	10000p	0.1μ	1μ	10μ	100μ	1000μ	
GCD18	1.6X0.8 <0603>	100					1000pF	22000pF						
		50					1000pF	22000pF						
		25					27000pF	47000pF						
GCD21	2.0X1.25 <0805>	100					1000pF	0.10μF						
		50					15000pF	0.10μF						

Specially Designed Product to Reduce Shorts & Resin Electrode Product



Series	LXW (mm) <Size Code (inch)>	Rated Voltage (Vdc)	Capacitance Range (F)											
			0.1p	1p	10p	100p	1000p	10000p	0.1μ	1μ	10μ	100μ	1000μ	
GCE18	1.6X0.8 <0603>	100					1000pF	22000pF						
		50					1000pF	22000pF						

Continued on the following page. ↗

Series	LXW (mm) <Size Code (inch)>	Rated Voltage (Vdc)	Capacitance Range (F)												
			0.1p	1p	10p	100p	1000p	10000p	0.1μ	1μ	10μ	100μ	1000μ		
GCE18	1.6X0.8 <0603>	25							27000pF	47000pF					
GCE21	2.0X1.25 <0805>	100					220pF				0.10μF				
		50							15000pF		0.10μF				

Limited to Conductive Glue Mounting

Temperature Compensating Type



GCG



Series	LXW (mm) <Size Code (inch)>	Rated Voltage (Vdc)	Capacitance Range (F)												
			0.1p	1p	10p	100p	1000p	10000p	0.1μ	1μ	10μ	100μ	1000μ		
GCG15	1.0X0.5 <0402>	50				120pF	470pF								
GCG18	1.6X0.8 <0603>	50			10pF			2200pF							
GCG21	2.0X1.25 <0805>	50					1000pF		10000pF						

High Dielectric Constant Type



GCG



Series	LXW (mm) <Size Code (inch)>	Rated Voltage (Vdc)	Capacitance Range (F)													
			0.1p	1p	10p	100p	1000p	10000p	0.1μ	1μ	10μ	100μ	1000μ			
GCG15	1.0X0.5 <0402>	50				220pF	470pF									
		25						5600pF	10000pF							
		16							15000pF	0.10μF						
GCG18	1.6X0.8 <0603>	100					1000pF	0.10μF								
		50				220pF			0.22μF							
		25					1000pF			0.47μF						
		16							68000pF	1.0μF						
		10										2.2μF				
GCG21	2.0X1.25 <0805>	100							10000pF							
		50						18000pF	1.0μF							
		35								0.68μF	1.0μF					
		25								39000pF	1.0μF					
		16									0.33μF	4.7μF				
GCG31	3.2X1.6 <1206>	50								0.22μF	0.33μF					
		25								0.15μF	10μF					
		16									0.68μF	4.7μF				
		6.3											22μF			
GCG32	3.2X2.5 <1210>	50										10μF				
		35										10μF				
		25										3.3μF	10μF			
		16											6.8μF	10μF		
		6.3											47μF			

Capacitors

Resin External Electrode Type



Series	LXW (mm) <Size Code (inch)>	Rated Voltage (Vdc)	Capacitance Range (F)													
			0.1p	1p	10p	100p	1000p	10000p	0.1μ	1μ	10μ	100μ	1000μ			
GCJ18	1.6X0.8 <0603>	100					1000pF			0.10μF						
		50					1000pF			0.22μF						
		35							33000pF		68000pF					
		25					1000pF				1.0μF					
		16						10000pF			0.47μF					
		10								0.12μF		0.22μF				
		6.3										2.2μF		4.7μF		
GCJ21	2.0X1.25 <0805>	250					1000pF			22000pF						
		100					220pF				1.0μF					
		50					330pF				1.0μF					
		35								0.12μF		0.47μF				
		25					470pF					2.2μF				
		16									0.27μF		4.7μF			
		10										2.2μF		10μF		
GCJ31	3.2X1.6 <1206>	1k					1000pF			10000pF						
		630					1000pF			22000pF						
		250							15000pF		0.10μF					
		100								0.10μF		1.0μF				
		50									0.27μF		4.7μF			
		35									0.56μF		1.0μF			
		25									0.12μF		10μF			
		16										1.5μF		10μF		
		10											6.8μF		22μF	
GCJ32	3.2X2.5 <1210>	1k						15000pF		22000pF						
		630						6800pF		47000pF						
		250								68000pF		0.22μF				
		100									2.2μF		4.7μF			
		50										4.7μF		10μF		
		25											4.7μF			
		16											6.8μF		22μF	
GCJ43	4.5X3.2 <1812>	1k							33000pF		47000pF					
		630							33000pF		0.10μF					
		250									0.15μF		0.47μF			
GCJ55	5.7X5.0 <2220>	1k							68000pF		0.10μF					
		630								0.10μF		0.22μF				
		250									0.33μF		1.0μF			

Metal Terminal Type

High Effective Capacitance & High Ripple Resistance



KC3



Series	LXW (mm)	Rated Voltage (Vdc)	Capacitance Range (F)											
			0.1p	1p	10p	100p	1000p	10000p	0.1μ	1μ	10μ	100μ	1000μ	
KC355	6.1X5.3	630								0.10μF	1.2μF			
		450								0.22μF	2.2μF			
		250								0.47μF	2.2μF			

Safety Standard Certified Type MF (IEC60384-14 X1/Y2 Class)



KCA



Series	LXW (mm)	Rated Voltage (V)	Capacitance Range (F)											
			0.1p	1p	10p	100p	1000p	10000p	0.1μ	1μ	10μ	100μ	1000μ	
KCA55	6.1X5.3	AC250 (r.m.s.)				100pF			10000pF					

High Effective Capacitance



KCM



Series	LXW (mm)	Rated Voltage (Vdc)	Capacitance Range (F)												
			0.1p	1p	10p	100p	1000p	10000p	0.1μ	1μ	10μ	100μ	1000μ		
KCM55	6.1X5.3	100									4.7μF	22μF			
		63									4.7μF	22μF			
		50									4.7μF	33μF			
		35										10μF	47μF		
		25										15μF	68μF		

3 Terminal Low ESL Type for Automotive



NFM



Series	LXW (mm) <Size Code (inch)>	Rated Voltage (Vdc)	Capacitance Range (F)											
			0.1p	1p	10p	100p	1000p	10000p	0.1μ	1μ	10μ	100μ	1000μ	
NFM21	2.0X1.25 <0805>	50				220pF			22000pF					
		16									1.0μF			
		10							0.10μF	0.47μF				
NFM31	3.2X1.6 <1206>	100						10000pF						
		50						10000pF	0.10μF					

Chip Monolithic Ceramic Capacitors For Medical Devices

For Implanted Medical Devices

Temperature Compensating Type



GCH

Medical Device

Series	LXW (mm) <Size Code (inch)>	Rated Voltage (Vdc)	Capacitance Range (F)												
			0.1p	1p	10p	100p	1000p	10000p	0.1μ	1μ	10μ	100μ	1000μ		
GCH15	1.0X0.5 <0402>	50		1.0pF					1000pF						
GCH18	1.6X0.8 <0603>	100		1.0pF					1500pF						
		50		1.0pF					3300pF						
GCH21	2.0X1.25 <0805>	100				100pF			3300pF						
		50					1000pF		22000pF						
GCH31	3.2X1.6 <1206>	100						2200pF		10000pF					
		50						4700pF		47000pF					

High Dielectric Constant Type



GCH

Medical Device

Series	LXW (mm) <Size Code (inch)>	Rated Voltage (Vdc)	Capacitance Range (F)												
			0.1p	1p	10p	100p	1000p	10000p	0.1μ	1μ	10μ	100μ	1000μ		
GCH15	1.0X0.5 <0402>	100				220pF		4700pF							
		50				220pF				0.10μF					
		25						10000pF		47000pF					
		16							47000pF		0.22μF				
		10								0.10μF		1.0μF			
GCH18	1.6X0.8 <0603>	100				1000pF				0.10μF					
		50				1000pF				0.22μF					
		25						47000pF		1.0μF					
		16							0.10μF		1.0μF				
		10									2.2μF				
GCH21	2.0X1.25 <0805>	100					10000pF			1.0μF					
		50						47000pF		1.0μF					
		35								1.0μF		4.7μF			
		25								0.22μF		4.7μF			
		16								1.0μF		4.7μF			
GCH31	3.2X1.6 <1206>	100							0.10μF		1.0μF				
		50								0.47μF		2.2μF			
		25									2.2μF		4.7μF		
		16									4.7μF		10μF		
		10										10μF			
GCH32	3.2X2.5 <1210>	100									2.2μF				
		50								1.0μF		4.7μF			
		25										4.7μF			
		16										10μF			
		10											22μF		
6.3												47μF			

Lead Type Ceramic Capacitors For General Purpose

Disc Type (Safety Standard Certified Type)



DE1/DE2/DEJ

Type KX (Reinforced Insulation Type) -IEC60384-14 X1/Y1 Class

General Safety standard

Series	D (mm)	Rated Voltage (V)	Capacitance Range (F)												
			0.1p	1p	10p	100p	1000p	10000p	0.1μ	1μ	10μ	100μ	1000μ		
DE11X	9.0	AC250 (r.m.s.)			10pF	68pF									
DE1B3	7.0 to 8.0	AC300 (r.m.s.)				100pF	680pF								
	7.0 to 8.0	AC250 (r.m.s.)				100pF	680pF								
DE1E3	7.0 to 12.0	AC300 (r.m.s.)					1000pF	4700pF							
	7.0 to 12.0	AC250 (r.m.s.)					1000pF	4700pF							

Type KY (Basic Insulation Type) -IEC60384-14 X1/Y2 Class

General Safety standard

Series	D (mm)	Rated Voltage (V)	Capacitance Range (F)												
			0.1p	1p	10p	100p	1000p	10000p	0.1μ	1μ	10μ	100μ	1000μ		
DE21X	8.0	AC250 (r.m.s.)			10pF	68pF									
DE2B3	7.0 to 8.0	AC300 (r.m.s.)				100pF	680pF								
	7.0 to 8.0	AC250 (r.m.s.)				100pF	680pF								
DE2E3	7.0 to 10.0	AC300 (r.m.s.)					1000pF	4700pF							
	7.0 to 10.0	AC250 (r.m.s.)					1000pF	4700pF							
DE2F3	14.0	AC300 (r.m.s.)						10000pF							
	14.0	AC250 (r.m.s.)						10000pF							

The Electrical Appliance and Material Safety Law of Japan

General

Series	D (mm)	Rated Voltage (V)	Capacitance Range (F)												
			0.1p	1p	10p	100p	1000p	10000p	0.1μ	1μ	10μ	100μ	1000μ		
DEJE3	7.0 to 11.0	AC250 (r.m.s.)					1000pF	4700pF							
DEJF3	8.0 to 11.0	AC250 (r.m.s.)						4700pF	10000pF						

Disc Type (Ultra-high-voltage)



DHR

General Deflecting crack Soldering crack

Series	D (mm)	Rated Voltage (Vdc)	Capacitance Range (F)												
			0.1p	1p	10p	100p	1000p	10000p	0.1μ	1μ	10μ	100μ	1000μ		
DHR4E	8.0 to 18.0	15k				100pF	1000pF								
	8.0 to 16.0	12k				100pF	1000pF								
	8.0 to 15.0	10k				100pF	1000pF								
DHRB3	8.0 to 18.0	15k				100pF	1000pF								
	8.0 to 16.0	12k				100pF	1000pF								
	8.0 to 15.0	10k				100pF	1000pF								

Series	LxW (mm)	Rated Voltage (Vdc)	Capacitance Range (F)											
			0.1p	1p	10p	100p	1000p	10000p	0.1μ	1μ	10μ	100μ	1000μ	
RDED7	7.5X5.5	630								68000pF				
		450								0.15μF				
		250								0.22μF	0.33μF			
	7.5X7.5	450								0.22μF	0.56μF			
		250								0.47μF	1.0μF			
	7.5X8.0	630								0.10μF	0.27μF			
	7.7X12.5	450									1.0μF	1.2μF		
		250										2.2μF		
7.7X13.0	630								0.47μF	0.56μF				
RDER7	4.0X3.5	100				220pF						22000pF		
		50				220pF						0.1μF		
		25										0.1μF		
	4.5X3.5	500					1000pF					10000pF		
		250					1000pF					22000pF		
		100									33000pF		0.47μF	
		50									0.15μF		0.47μF	
	5.0X3.5	100					220pF						0.47μF	
		50					220pF						0.47μF	
		25											0.1μF	
	5.5X4.0	1k					470pF						10000pF	
		630					1000pF						22000pF	
		500									15000pF		47000pF	
		250									33000pF		0.10μF	
		100									0.15μF		1.0μF	
		50										0.68μF		2.2μF
	5.5X5.0	1k									15000pF		22000pF	
		630									33000pF		47000pF	
		500									68000pF		0.10μF	
		250									0.15μF		0.22μF	
		50												3.3μF
	7.5X5.5	1k									33000pF		47000pF	
		630									68000pF		0.10μF	
		500									0.15μF		0.22μF	
		250									0.33μF		0.47μF	
	7.5X7.5	500									0.33μF		0.47μF	
		250									0.68μF		1.0μF	
	7.5X8.0	1k									68000pF		0.10μF	
		630									0.15μF		0.22μF	
	7.7X12.5	500									0.68μF		1.0μF	
250												2.2μF		
7.7X13.0	1k											0.22μF		
	630											0.47μF		

Lead Type Ceramic Capacitors For Automotive

Safety Standard Certified for Automotive

Type KJ -IEC60384-14 X1/Y2 Class



DE6

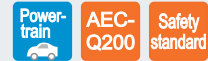

Series	D (mm)	Rated Voltage (V)	Capacitance Range (F)												
			0.1p	1p	10p	100p	1000p	10000p	0.1μ	1μ	10μ	100μ	1000μ		
DE6B3	8.0 to 9.0	AC300 (r.m.s.)				100pF	680pF								
DE6E3	7.0 to 12.0	AC300 (r.m.s.)				1000pF	4700pF								

Powertrain/Safety (AEC-Q200)

Temperature Compensating Type

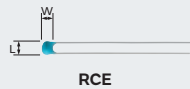

RCE



Series	LxW (mm)	Rated Voltage (Vdc)	Capacitance Range (F)												
			0.1p	1p	10p	100p	1000p	10000p	0.1μ	1μ	10μ	100μ	1000μ		
RCE5C	3.6X3.5	100		1.0pF				1500pF							
		50		1.0pF				3900pF							
	4.0X3.5	100					1800pF	3300pF							
		50					4700pF	22000pF							
	5.5X4.0	1k				100pF	1000pF								
		630			10pF		3300pF								
		250			10pF		15000pF								
		100					3900pF	10000pF							
50							27000pF	56000pF							
RCE7U	4.0X3.5	250				100pF	4700pF								
		1k			10pF	1000pF									
	5.5X4.0	630			10pF	4700pF									
		250					6800pF	10000pF							
	5.5X5.0	1k					1500pF	2200pF							
		630					6800pF	10000pF							
	7.5X5.5	1k					3300pF	4700pF							
		630					15000pF	22000pF							
	7.5X8.0	1k					6800pF	10000pF							
		630					33000pF	47000pF							
	7.7X13.0	1k						20000pF							
		630							94000pF						

High Dielectric Constant Type



RCE

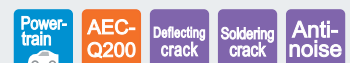

Series	LxW (mm)	Rated Voltage (Vdc)	Capacitance Range (F)											
			0.1p	1p	10p	100p	1000p	10000p	0.1μ	1μ	10μ	100μ	1000μ	
RCEC7	4.0X3.5	50									1.0μF			
	5.5X4.0	50										4.7μF		
	5.5X5.0	100									1.5μF	2.2μF		
		50											10μF	
	5.5X7.5	100											4.7μF	

Continued on the following page. ↗

Series	LXW (mm)	Rated Voltage (Vdc)	Capacitance Range (F)											
			0.1p	1p	10p	100p	1000p	10000p	0.1μ	1μ	10μ	100μ	1000μ	
RCEC7	5.5X7.5	50											22μF	
RCER7	3.6X3.5	100				220pF				22000pF				
		50				220pF				0.10μF				
RCER7	4.0X3.5	25								0.10μF		0.22μF		
		250				1000pF				22000pF				
		100							33000pF		0.33μF			
RCER7	5.5X4.0	50								0.15μF		0.47μF		
		25								0.33μF		1.0μF		
		1k				1000pF		10000pF						
RCER7	5.5X5.0	630				1000pF		22000pF						
		250						33000pF		0.10μF				
		100								0.15μF		1.0μF		
		50									0.68μF		2.2μF	
RCER7	5.5X7.5	25										1.5μF	4.7μF	
		1k					15000pF	22000pF						
		630					33000pF	47000pF						
RCER7	7.5X5.5	250								0.15μF		0.22μF		
		50									3.3μF	4.7μF		
		25										10μF		
RCER7	7.5X7.5	50										10μF		
		25										22μF		
RCER7	7.5X8.0	1k						33000pF	47000pF					
		630						68000pF	0.10μF					
RCER7	7.5X12.5	250								0.33μF	0.47μF			
		25									0.68μF	1.0μF		
RCER7	7.7X13.0	1k								0.15μF	0.22μF			
		630										2.2μF		
RCER7	7.7X13.0	1k									0.22μF			
		630										0.47μF		

Powertrain/Safety (AEC-Q200) 150°C Max.

Temperature Compensating Type



RH

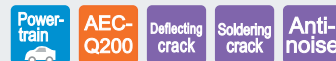

Series	LXW (mm)	Rated Voltage (Vdc)	Capacitance Range (F)											
			0.1p	1p	10p	100p	1000p	10000p	0.1μ	1μ	10μ	100μ	1000μ	
RHE5G	3.6X3.5	100				100pF				1500pF				
		50				100pF				3900pF				
RHE5G	4.0X3.5	100						1800pF	3300pF					
		50						4700pF	10000pF					

High Dielectric Constant Type



RH

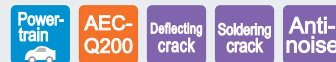

Series	LXW (mm)	Rated Voltage (Vdc)	Capacitance Range (F)											
			0.1p	1p	10p	100p	1000p	10000p	0.1μ	1μ	10μ	100μ	1000μ	
RHEL8	3.6X3.5	100				220pF				22000pF				
		50				220pF				0.10μF				
		25								0.10μF		0.22μF		

Continued on the following page. ↗

Capacitors

Series	LXW (mm)	Rated Voltage (Vdc)	Capacitance Range (F)											
			0.1p	1p	10p	100p	1000p	10000p	0.1μ	1μ	10μ	100μ	1000μ	
RHEL8	4.0X3.5	100							33000pF	0.10μF				
		50							0.15μF	0.33μF				
		25							0.33μF	1.0μF				
	5.5X4.0	100							0.15μF	0.22μF				
		50							0.47μF	2.2μF				
		25							1.5μF	4.7μF				
	5.5X5.0	50							3.3μF	4.7μF				
		25									10μF			
	5.5X7.5	50									10μF			
25											22μF			

High Voltage Ceramic Capacitors

High Voltage AC Rated Type



General

Series	LXW (mm)	Rated Voltage (V)	Capacitance Range (F)											
			0.1p	1p	10p	100p	1000p	10000p	0.1μ	1μ	10μ	100μ	1000μ	
DHK3V	-	AC10k (r.m.s.)				100pF	1000pF							

Ultra-high-voltage

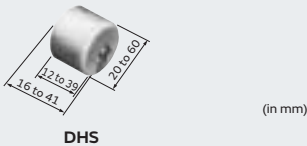

General

Series	LXW (mm)	Rated Voltage (Vdc)	Capacitance Range (F)											
			0.1p	1p	10p	100p	1000p	10000p	0.1μ	1μ	10μ	100μ	1000μ	
DHS4E	-	40k				140pF	2000pF							
		30k				190pF	2700pF							
		20k				280pF	4000pF							
		15k				370pF	5300pF							
		10k				560pF	8000pF							
DHSF4	-	40k				340pF	2700pF							
		30k				460pF	3600pF							
		20k				600pF	4800pF							

Polymer Aluminum Electrolytic Capacitors



ECAS

General
Effective Cap

Series	LXW (mm)	Rated Voltage (Vdc)	Capacitance Range (F)													
			0.1p	1p	10p	100p	1000p	10000p	0.1μ	1μ	10μ	100μ	1000μ			
ECAS	7.3X4.3	25									10μF	22μF				
		16									6.8μF	47μF				
		12.5									10μF	100μF				
		10									10μF	150μF				
		6.3									10μF	330μF				
		4										68μF	330μF			
		2.5											330μF	470μF		
		2											100μF	560μF		

Trimmer Capacitors

Trimmer Capacitors are variable capacitance capacitors, used for adjusting characteristics of electronic equipment.

Mounting Method	Soldering Method	Series	Max. Height	Size (WXL)	Rated Voltage	Operating Temperature Range	Remarks
Surface Mounting	Reflow Soldering Methods	 TZR1	0.9mm max.	1.5X1.7mm	25V	-25 to 85°C	
		 TZY2	1.25mm max.	2.5X3.2mm	25V	-25 to 85°C	
		 TZC3	1.7mm max.	3.2X4.5mm	100V	-25 to 85°C	
		 TZW4	2.6mm max.	4.2X5.2mm	250V	-55 to 125°C	for High Frequency Power
		 TZB4_AA	3.2mm max.	4.0X4.5mm	100V/50V	-25 to 85°C	
		 TZB4_BA	3.2mm max.	4.0X4.5mm	100V/50V	-25 to 85°C	
	Flow Soldering Methods	 TZB4_AB	3.2mm max.	4.0X4.5mm	100V/50V	-25 to 85°C	with Cover Film
		 TZB4_BB	3.2mm max.	4.0X4.5mm	100V/50V	-25 to 85°C	with Cover Film

Please refer to p. 74 for Supercapacitors (EDLC).

Detailed Catalogs

For more details, please refer to our printed catalogs and the PDF catalogs on our website.



- Chip Monolithic Ceramic Capacitors Cat. No. C02E
- Chip Monolithic Ceramic Capacitors for Automotive Cat. No. C03E
- Safety Standard Certified Ceramic Capacitors/High Voltage Ceramic Capacitors Cat. No. C85E
- Ceramic Trimmer Capacitors Cat. No. T13E
- Polymer Aluminum Electrolytic Capacitors Cat. No. C90E
- Radial Lead Type Monolithic Ceramic Capacitors Cat. No. C49E
- High Performance Supercapacitors (EDLC) DMF Series Cat. No. O83E
- High Performance Supercapacitors (EDLC) DMT Series Cat. No. O84E

Noise Suppression Products/ EMI Suppression Filters

Broad lineup of Noise Suppression Products and EMI Suppression Filters

Summary

Using Murata's ceramic processing technology and unique materials, we offer a variety of Noise Suppression Products and EMI Suppression Filters.

Lineup

- EMI (chip and lead type)
- Noise Suppression Products for Automotive
- ESD Protection Devices ● AC Line Filters ● Ferrite Cores



Noise Suppression Filters (Chip Ferrite Bead)

		Series	Size Code inch (mm)	Max. Rated Current (mA)	Impedance (Ω) at 100MHz			Effective Frequency Range (Hz) (For Reference Only)																
					10	100	1000	10k	100k	1M	10M	100M	1G	10G										
For General Band Noise	Universal Type [Power Lines / Signal Lines]	BLM02AX	01005 (0402)	750	10	70	120	240																
		BLM03AX	0201 (0603)	1000	10		80	120	240	600	1000													
		BLM15AX	0402 (1005)	1740	10	30	70	120	220	600	1000													
	For General Signal Lines	BLM03AG	0201 (0603)	-	10		80	120	240	600	1000													
		BLM15AG	0402 (1005)	-	10		70	120	220	600	1000													
		BLM18AG	0603 (1608)	-			220	120	150	330	470	600	1000											
		BLM21AG	0805 (2012)	-			220	120	150	330	470	700	900	600	800	1000								
		BLM18TG	0603 (1608)	-			120	220		600	1000													
		BLA2AA (4 circuits array)	0804 (2010)	-			120	220		600	1000													
		BLA31AG (4 circuits array)	1206 (3216)	-		30	60	120	220		600	1000												
		Signal Lines Type	For High Speed Signal Lines	BLM02BX*	01005 (0402)	-			120	150	240													
				BLM03BX	0201 (0603)	-						1800	1000											
				BLM03B	0201 (0603)	-	10	22	33	47	56	75	80			600	470							
	BLM15B			0402 (1005)	-	5	10	22	33	47	75	120	240		600	470	1800	1000						
	BLM18B		0603 (1608)	-	5	10	22	33	47	60	75	140	200	250	330	600	1500	2200	1000	1800	2500			
	BLM21B		0805 (2012)	-	5			75	60	200	250	330	420	470	700	1500	2200	2700	1000	1800	2250			
	BLA2AB (4 circuits array)		0804 (2010)	-	10	22		47	75	120	220			600	470	1000								
	BLA31BD (4 circuits array)		1206 (3216)	-				120	220		600	470	1000											
	For Digital Interface Lines	BLM18RK	0603 (1608)	-				120	220		600	470	1000											
		BLM21RK	0805 (2012)	-				120	220		600	470	1000											

* The derating of rated current is required for some items according to the operating temperature.
For automotive grade products, please refer to the catalog C51E, "EMI Suppression Filters (for DC)/Chip Inductors for Automotive."

Continued on the following page. ↗

Noise Suppression Products/EMI Suppression Filters

	Series	Size Code inch (mm)	Max. Rated Current (mA)	Impedance (Ω) at 100MHz			Effective Frequency Range (Hz) (For Reference Only)														
				10	100	1000	10k	100k	1M	10M	100M	1G	10G								
For General Band Noise	Power Lines Type	BLM02PX*	01005 (0402)	1100	10(1.1A)22(0.75A) 60 (0.5A) 33 (0.55A)																
		BLM03PX*	0201 (0603)	1800		33 (1.5A) 22 (1.8A)	80 (1A)														
		BLM03PG	0201 (0603)	900		33 (0.75A) 22 (0.9A)															
		BLM15KD*	0402 (1005)	3800		30 (3.1A) 20 (3.8A)	120 (1.5A)														
		BLM15PX*	0402 (1005)	3000		60 (2.5A) 120 (2A) 220 (1.4A) 470 (1A) 33 (3A)	80 (2.3A) 180 (1.5A) 330 (1.2A) 600 (0.9A)														
		BLM15PD*	0402 (1005)	2200		60 (1.7A) 120 (1.3A) 30 (2.2A)	80 (1.5A)														
		BLM15PG	0402 (1005)	1000		10 (1A)															
		BLM18PG*	0603 (1608)	3000		33 (3A) 120 (2A) 220 (1.4A) 470 (1A) 30 (1A) 60 (0.5A) 180 (1.5A) 330 (1.2A)															
		BLM21PG*	0805 (2012)	6000		30 (4A) 220 (2A) 22 (6A) 60 (3.5A) 120 (3A) 330 (1.5A)															
		BLM31PG*	1206 (3216)	6000		50 (3.5A) 390 (2A) 33 (6A) 120 (3.5A) 600 (1.5A)															
		BLM41PG*	1806 (4516)	6000		75 (3.5A) 470 (2A) 60 (6A) 180 (3.5A) 1000 (1.5A)															
		BLM18SN* (Low DC Resistance Type)	0603 (1608)	8000		22 (8A)															
		BLM18KG* (Low DC Resistance Type)	0603 (1608)	6000		30 (5A) 70 (3.5A) 220 (2.2A) 470 (1.5A) 26 (6A) 100 (3A) 120 (3A) 330 (1.7A) 600 (1.3A)															
		BLM18SD* (Low DC Resistance Type)	0603 (1608)	6000		22 (6A)															
		BLM18SG* (Low DC Resistance Type)	0603 (1608)	6000		33 (6A) 120 (3A) 330 (1.5A) 26 (6A) 70 (4A) 220 (2.5A)															
		BLM21SN* (Low DC Resistance Type)	0805 (2012)	8500		30 (8.5A)															
		BLM31SN* (Low DC Resistance Type)	1206 (3216)	12000		50 (12A)															
		BLE32PN	1220 (3225)	10000		30 (10A)															
		For GHz Band Noise	Universal Type [Power Lines / Signal Lines]	BLM03EB*	0201 (0603)	600	25 (0.6A) 50 (0.4A)														
BLM15EG*	0402 (1005)			1500		220 (0.7A) 120 (1.5A)															
BLM15EX*	0402 (1005)			1800		220 (1.3A) 120 (1.8A) 330 (1.1A) 470 (0.95A)															
BLM18EG*	0603 (1608)			2000		120(2A) 330(0.5A) 470(0.5A) 100(2A) 220(2A/1A) 390(0.5A) 600(0.5A)															
BLM18HE*	0603 (1608)			800		1000(0.6A) 600(0.8A) 1500(0.5A)															
Signal Lines Type	BLM03HG		0201 (0603)	-					1000 600 1200												
	BLM03HD		0201 (0603)	-					600 1500 330 470 1000 1800												
	BLM03HB		0201 (0603)	-			190														
	BLM15HG		0402 (1005)	-					600 1000												
	BLM15HD		0402 (1005)	-					600 1000 1800												
	BLM15HB		0402 (1005)	-			120 220														
	BLM18HG		0603 (1608)	-					600 1000												
	BLM18HD		0603 (1608)	-					600 1000												
	BLM18HB		0603 (1608)	-			120 220 330														
	BLM18HK		0603 (1608)	-					600 1000 330 470												
	Signal Lines Type		BLM15GG	0402 (1005)	-					220 470											
			BLM15GA	0402 (1005)	-			75													
			BLM18GG	0603 (1608)	-					470											

	Series	Size Code inch (mm)	Max. Rated Current (A)	Impedance (Ω) at 100MHz			Effective Frequency Range (Hz) (For Reference Only)													
				10	100	1000	10k	100k	1M	10M	100M	1G	10G							
For General Band Noise	Large Current Type Power Lines Type	BLT5BPT*	2020 (5050)	11				68 (11A)												

* The derating of rated current is required for some items according to the operating temperature.
For automotive grade products, please refer to the catalog C51E, "EMI Suppression Filters (for DC)/Chip Inductors for Automotive."

Noise Suppression Products/EMI Suppression Filters

Noise Suppression Filters (Feed Through Chip EMI Filters)

	Series	Size Code inch (mm)	Max. Rated Current (mA)	Capacitance (F)						Effective Frequency Range (Hz) (For Reference Only)					
				10p	100p	1000p	10000p	0.1μ	1μ	10μ	10k	100k	1M	10M	100M
Universal Type [Power Lines / Signal Lines]	NFE31PT	1206 (3216)	6000	470 2200 22 47 100 220 1500											
	NFE61PT	2706 (6816)	2000	100 360 1000 33 68 180 680 4700											

Noise Suppression Filters (Chip LC Filters)

	Series	Size Code inch (mm)	Max. Rated Current (mA)	Cut-off Frequency (MHz)						Effective Frequency Range (Hz) (For Reference Only)												
				10	100	500	10k	100k	1M	10M	100M	1G	10G									
Signal Lines Type	NFL15ST	0402 (1005)	-	150 200 300 500																		
	NFL18ST	0603 (1608)	-	50 70 100 200 300 500																		
	NFL18SP	0603 (1608)	-	150 200 300 500																		
	NFL21SP	0805 (2012)	-	500																		
	NFA18SL (4 circuits array)	0603 (1608)	-	10	20	50	70	100	150							200	300	400				
	NFA18SD (4 circuits array)	0603 (1608)	-	200 400																		
	NFA21SL (4 circuits array)	0805 (2012)	-	280 310																		
	NFW31SP	1206 (3216)	-	400																		

Noise Suppression Filters (Chip EMIFIL®)

	Series	Size Code inch (mm)	Max. Rated Current (mA)	Impedance (Ω) at 1MHz				Effective Frequency Range (Hz) (For Reference Only)					
				1	10	100	1000	10k	100k	1M	10M	100M	1G
Signal Lines Type	NFZ5BBW_LN10	2020 (5050)	-	29 6.7 10 14 22 45 61 140 4.5 7.6 17 31 52 97									
Universal Type [Power Lines / Signal Lines]	NFZ2HBM_10	1008 (2520)	1200	1.5 2.9 6.1 11 24 60 4.4 8.4 17 33									
	NFZ32BW_10*	1210 (3225)	2550	3.6 7.4 15 32 70 150 290 620 9.0 21 42 110 220 450 880									
	NFZ32BW_11*	1210 (3225)	2900	3.3 6.8 9.8 19 31 65 150 8.4 12 21 52 100									

	Series	Size Code inch (mm)	Max. Rated Current (mA)	Impedance (Ω) at 100MHz				Effective Frequency Range (Hz) (For Reference Only)					
				100	1000	5000	10000	10k	100k	1M	10M	100M	1G
Signal Lines Type	NFZ32SW_10	1210 (3225)	-	300 900									
Universal Type [Power Lines / Signal Lines]	NFZ18SM_10	0603 (1608)	1250	120 250 500 700									
	NFZ2MSM_10	0806 (2016)	4000	100 180 300 600									

	Series	Size Code inch (mm)	Max. Rated Current (mA)	Impedance (Ω) at 900MHz			Impedance (Ω) at 1.7GHz			Effective Frequency Range (Hz) (For Reference Only)					
				100	1000	5000	100	1000	5000	10k	100k	1M	10M	100M	1G
Signal Lines Type	NFZ15SG_10	0402 (1005)	-	150 4600 770 2600			1200 1800 900 1450								
	NFZ15SG_11	0402 (1005)	-	150 330			160 540								

* The derating of rated current is required for some items according to the operating temperature.
For automotive grade products, please refer to the catalog C51E, "EMI Suppression Filters (for DC)/Chip Inductors for Automotive."

Noise Suppression Filters (Chip Common Mode Choke Coils/ Chip Common Mode Noise Filters)



Noise Suppression Products/EMI Suppression Filters

	Series	Size Code inch (mm)	Max. Rated Current (mA)	Common Mode Impedance (Ω) at 100MHz			Effective Frequency Range (Hz) (For Reference Only)						
				100	500	1000	100k	1M	10M	100M	1G	10G	
Signal Lines Type	For Audio Lines	DLM11G	0504 (1210)	-	600								
	For Ultra- High- Speed Signal Lines	DLM0QSN	025020 (0605)	-	90								
		DLM0NSN	03025 (0806)	-	90								
		DLM11S	0504 (1210)	-	45 90								
		NFPOR	018012 (0403)	-	(65)(90)								
		NFPOQ	025020 (0605)	-	(65)(90)								
		DLP0RSN	018012 (0403)	-	65 90								
		DLPOQSN	025020 (0605)	-	65 90								
		DLP0QSA	025020 (0605)	-	15 7 35								
		DLP0NSC	03025 (0806)	-	28 90								
		DLP0NSN	03025 (0806)	-	35 90 67 120								
		DLP0NSA	03025 (0806)	-	15 7								
		DLP11SN	0504 (1210)	-	67 90 120 160 200 280 330								
		DLP11SA	0504 (1210)	-	35 90 67								
		DLP11RN	0504 (1210)	-	45								
		DLP11RB	0504 (1210)	-	15 40								
		DLP11TB	0504 (1210)	-	80								
		DLP31S	1206 (3216)	-	120 220 550								
		DLP1NDN (2 circuits array)	05025 (1506)	-	35 90 67								
		DLP2ADA (2 circuits array)	0804 (2010)	-	35 90 67								
		DLP2ADN (2 circuits array)	0804 (2010)	-	90 120 160 200 280								
		DLP31DN (2 circuits array)	1206 (3216)	-	90 130 200 320 440								
		DLW21S	0805 (2012)	-	90 67 120 180 210 260 370 500 920								
		DLW21H	0805 (2012)	-	90 67 120 180								
		DLW31SN	1206 (3216)	-	90 160 260 600 1000 2200								
		DLW43SH	1812 (4532)	-									
		Universal Type [Power Lines / Signal Lines]	DLW44S*	1515 (4040)	3100	(100) (250) (400) (850) (2200) (1700)(2400)							
DLW5AH/DLW5BS*	2014 /2020 (5036)/(5050)		5000	(190) (350) (500) (800) (1500)(4000) (600) (1000) (3000)									
DLW5AT*/DLW5BT*	2014 /2020 (5036)/(5050)		6000	(50) (110) (230) (330) (500) (850)(1100) (2700) (100)(150) (250) (400)									

* The derating of rated current is required for some items according to the operating temperature.
For automotive grade products, please refer to the catalog C51E, "EMI Suppression Filters (for DC)/Chip Inductors for Automotive."













Continued on the following page. ↗

Noise Suppression Products/EMI Suppression Filters

	Series	Size Code inch (mm)	Max. Rated Current (A)	Common Mode Impedance (Ω) at 10MHz				Effective Frequency Range (Hz) (For Reference Only)					
				100	500	1000		100k	1M	10M	100M	1G	10G
Large Current Type for Automotive Available	 PLT5BP*	2020 (5050)	5.6	100	200	300	500						
	 PLT10H*	-	18	45	100	400	900						

	Series	Size Code inch (mm)	Max. Rated Current (mA)	Common Mode Impedance (Ω) at 100MHz			Effective Frequency Range (Hz) (For Reference Only)					
				100	500	1000	100k	1M	10M	100M	1G	10G
Large Current Type for Automotive Available	 UCMH0907	3527 (9070)	5000		(700)							

Noise Suppression Filters (Block Type)

	Series	Height (mm)	Rated Voltage (Vdc)	Rated Current (A)	Effective Frequency Range (Hz) (For Reference Only)						
					10k	100k	1M	10M	100M	1G	10G
Power Lines Type	SMD Type	 BNX022*	3.1	50	10						
		 BNX023*	3.1	100	15						
		 BNX024*	3.5	50	15						
		 BNX025*	3.5	25	15						
		 BNX026*	3.5	50	15						
		 BNX027*	3.5	16	15						
		 BNX028*	3.5	16	15						
		 BNX029*	3.5	6.3	15						
	Lead Type	 BNX002	13 max.	50	10						
		 BNX003	13 max.	150	10						
		 BNX005	13.5 max.	50	15						
		 BNX012*	8.5 max.	50	15						
		 BNX016*	8.5 max.	25	15						

* The derating of rated current is required for some items according to the operating temperature.
For automotive grade products, please refer to the catalog C51E, "EMI Suppression Filters (for DC)/Chip Inductors for Automotive."

ESD Protection Devices

Support ESD protection for various kinds of electronic devices.

Ceramic ESD Protection Devices LXES_A Series

Applying Murata's original ceramic technology for excellent ESD suppression performance and ultra-small capacitance value.

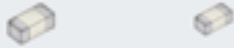

Silicon ESD Protection Devices LXES_B Series

Applying accumulated design technology for excellent ESD suppression performance.



Silicon ESD Protection Devices LXES_T Series

Applying accumulated design technology for excellent ESD suppression performance.

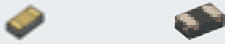





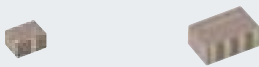



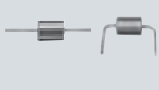













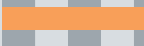





ESD Protection Devices with Common Mode Choke Coil LXES_D Series

Applying Murata's original ceramic technology for excellent ESD suppression performance, small capacitance value, and common mode filter performance.



Noise Suppression Filters (Lead Type), Others

		Series							Effective Frequency Range (Hz) (For Reference Only)						
									10k	100k	1M	10M	100M	1G	10G
Lead Type EMIFIL®															
	BLL18AG	BL01	BL02	BL03	DSS1	DSN9H	DST9H								
EMIGUARD®															
	VFC2H	VFR3V	VFS6V	VFS9V											
AC Line Filters	Common Mode Choke Coil														
	Hybrid Common Mode Choke Coil														
Common Mode Choke Coils															
Microwave Absorbers															
Ferrite Core															
	FSRH	FSRB	FSRC	FSSA											

Detailed Catalogs

For more details, please refer to our printed catalogs and the PDF catalogs on our website.

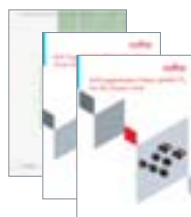

- EMI Suppression Filters (Lead Type EMIFIL®) Cat. No. C30E
- EMI Suppression Filters (for DC)/Chip Inductors for Automotive Cat. No. C51E
- EMI Suppression Filters (EMIFIL®) for AC Power Lines Cat. No. C09E
- Noise Suppression by EMIFIL® Digital Equipment Application Manual Cat. No. C33E
- Noise Suppression by EMIFIL® Application Guide Application Manual Cat. No. C35E
- Application Manual for Power Supply Noise Suppression and Decoupling for Digital ICs Cat. No. C39E
- Ferrite Core for EMI Suppression Microwave Absorber Cat. No. O63E

Inductors (Coils)

Broad lineup of Chip Inductors and Power Inductors

Summary

Murata's chip inductors are optimally designed, making full use of multiple construction techniques, such as the multilayer construction technique, film construction technique, and the wire wound construction technique according to the application, and realized small size and high-performance inductors. We offer an extensive lineup of inductors for power supplies to high frequency. In addition, newly adopted metal alloy material has extended the power inductor lineup.

Lineup

- Inductors for Power Lines ● RF Inductors
- Lineup



<http://psearch.en.murata.com/inductor/partnumber/>

WEB Product Search Engine

1 Search by part number

The applicable inductors can be searched by alphanumeric characters.



2 Search by specifications

Inductors can be searched by various specifications, such as the Inductance, DC Resistance, and Rated Current.



3 Search in the lineups

Inductors applicable to the conditions can be searched from the lineup of each series.

Lineup chart-in Series page



4 Search by competitor's part number (Cross reference)

The Murata part number applicable to the assumed specification can be found using a competitor's part number for Inductors.



Search results

The number of cases applicable to the current search conditions is always displayed in real time.

Click each search condition button to display the menu. The search results will change in real time with the selected conditions.



Clicking the "Current search conditions" opens a menu, and the filtered conditions can be checked.

The results can be sorted by clicking the ▲ button above the search results items.

Clicking the product name opens the details page, and more detailed information can be acquired.

The icons clearly indicate the status and the features of the product.

A simple specification sheet can be downloaded without opening the details page.

Inductors for Power Lines

- Metal alloy type -DFEC series-
- Multilayer type -LQM series-
- Wire wound type -LQH series-



Metal alloy type inductors have been added to inductor lineup!

We have an extensive lineup of inductors covering a wide range of sizes from 1.6 mm x 0.8 mm to 12 mm square, which are manufactured using multiple techniques including metal wire wound construction and ferrite lamination. We offer the optimum inductors for a wide range of applications including mobile devices such as wearable devices and smartphones, medical applications, industrial electronics, and on-board devices.

- Metal alloy type DFEC series
Features: Made using metal materials and rectangular wire to cope with large currents.
Applications: Power supply for smartphone digital circuits
- Multilayer type LQM series
Features: Low profile less than 2012 size
Applications: Power supply for wearable devices
- Wound type LQH series
Features: A wide lineup of 100μH or higher
Applications: Backlight power supply, chokes

Recommended lineup (General)

List of inductance values

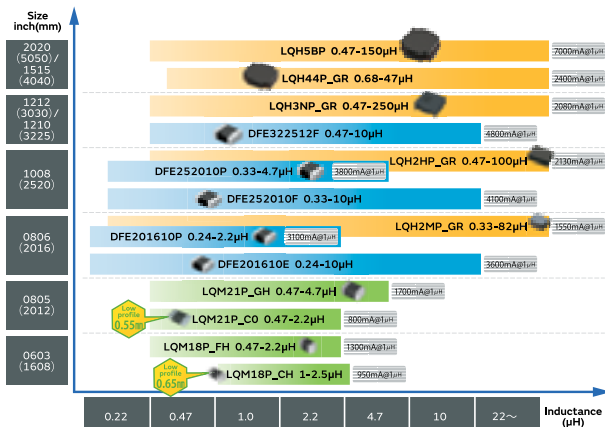

List of rated current values

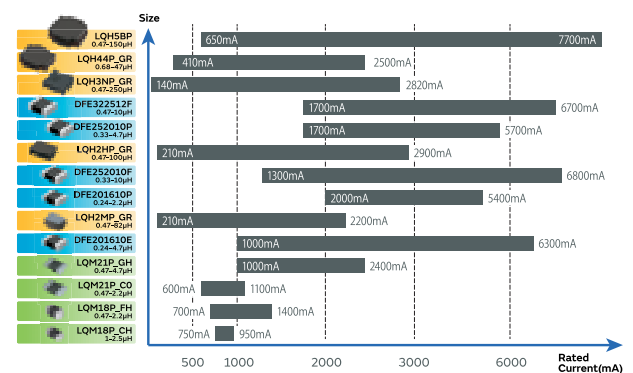

Recommended lineup (For Automotive)

List of inductance values

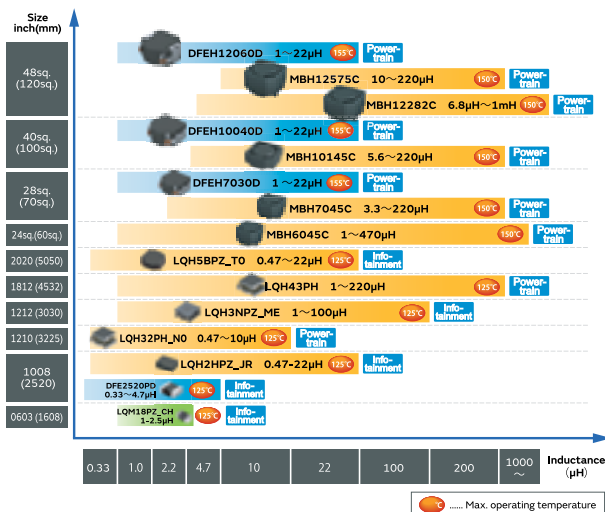

List of rated current values

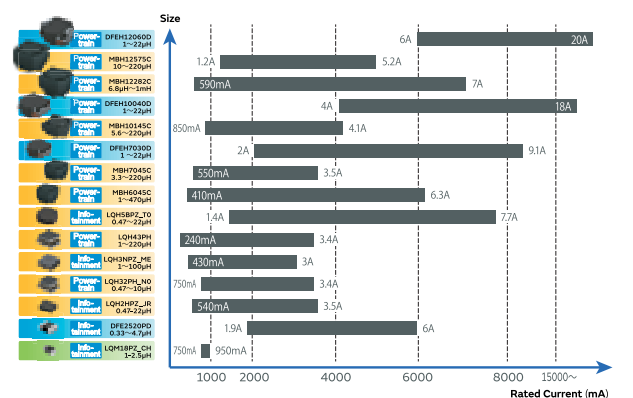

RF Inductors

- Film type -LQP series-
- Wire wound type -LQW series-
- Multilayer type -LQG series-

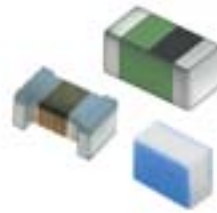

An RF inductor is used for matching applications and choke applications in the RF section, which has wireless communication functions. By using three characteristic methods, you can select the optimum series for the intended application. For a smartphone or a module, a film type LQP series, which is compact and also has high Q characteristics is optimum. For an RF inductor of size 1005 mm or more, the high Q wound type LQW series, which has a large rated current value, is recommended for use in a base station or STB, while the multilayer LQG series, which has a good balance between cost and performance, is recommended for a wide range of automotive applications, based on our market achievements over many years.

You can select the optimum series in our lineup, based on either the intended application or the relationship between the size and Q characteristics.

General (Small size)

Small size (0.8x0.4 mm or less) lineup

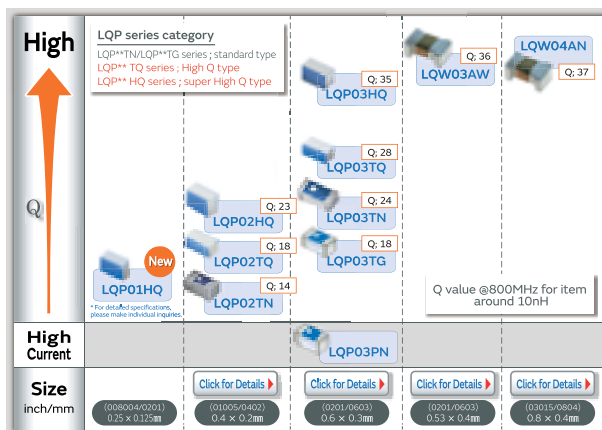

General (Large size)

Medium size (1.0x0.5 mm or more) lineup

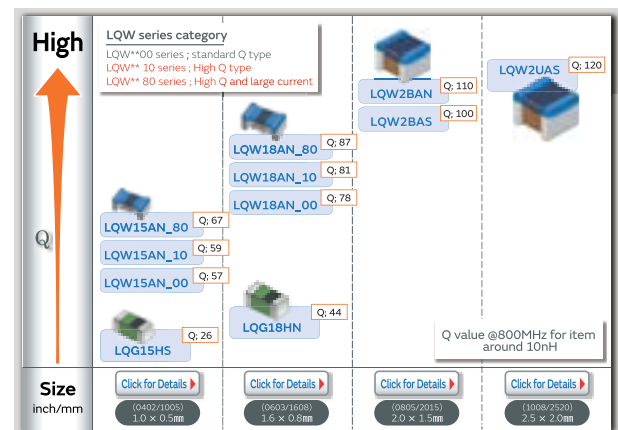

For Automotive

Large size (1.0x0.5 mm or more) lineup

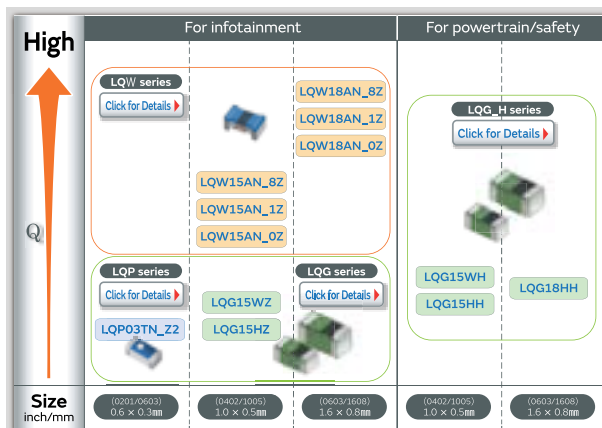

Lineup

General

Inductors for Power Lines

Series	Structure	Size Code inch (mm)	Applications	Inductance (H)										Rated Current Range		
				0.1n	1n	10n	100n	1μ	10μ	100μ	1m	10m				
LQM18FN_00	Multilayer Type	0603 (1608)	General					1μH	10μH						50mA to 150mA	
LQM18PN_BO		0603 (1608)	General					1.5μH							600mA	
LQM18PN_CO		0603 (1608)	General				470nH	2.2μH							700mA to 850mA	
LQM18PN_DO		0603 (1608)	General					2.5μH							700mA	
LQM18PN_DH		0603 (1608)	General					2.2μH							650mA	
LQM18PN_F0		0603 (1608)	General					1μH							600mA	
LQM18PN_FH		0603 (1608)	General				470nH	2.2μH							700mA to 1.4A	
LQM18PN_FR		0603 (1608)	General				220nH	4.7μH							620mA to 1.25A	
LQM18PN_GH		0603 (1608)	General					1μH	3.3μH						1.05A	
LQM18PW_CH		0603 (1608)	General					1μH	2.5μH						750mA to 950mA	
LQM21DN_00		Wire Wound Ferrite Core Type	0805 (2012)	General					1μH	47μH					7mA to 60mA	
LQM21FN_00			0805 (2012)	General					1μH	47μH					7mA to 220mA	
LQM21FN_70			0805 (2012)	General					4.7μH	10μH					100mA to 120mA	
LQM21FN_80			0805 (2012)	General					4.7μH	10μH					100mA to 120mA	
LQM21PN_CO			0805 (2012)	General				470nH	2.2μH						600mA to 1.1A	
LQM21PN_CA			0805 (2012)	General					2.2μH							1.05A
LQM21PN_CH			0805 (2012)	General				470nH	2.2μH							1.05A to 1.6A
LQM21PN_EH			0805 (2012)	General				240nH	2.2μH							1.1A to 2.8A
LQM21PN_GO			0805 (2012)	General				470nH	3.3μH							800mA to 1.3A
LQM21PN_GC			0805 (2012)	General					1μH	2.2μH						800mA to 900mA
LQM21PN_GH			0805 (2012)	General				470nH	4.7μH							1A to 2.4A
LQM21PN_GR			0805 (2012)	General					1μH	4.7μH						800mA to 1.3A
LQM21PN_GS			0805 (2012)	General					2.2μH	4.7μH						750mA to 950mA
LQM2MPN_DH			0806 (2016)	General					2.2μH							1.27A
LQM2MPN_EH			0806 (2016)	General				240nH	2.2μH							1.1A to 4.1A
LQM2MPN_GO			0806 (2016)	General				470nH	4.7μH							1.1A to 1.6A
LQM2MPN_GH			0806 (2016)	General				160nH	2.2μH							1.3A to 5A
LQM2HPN_CH			1008 (2520)	General				240nH	2.2μH							850mA to 2.55A
LQM2HPN_E0			1008 (2520)	General					560nH							1.5A
LQM2HPN_EH			1008 (2520)	General				240nH	2.2μH							1.3A to 4.5A
LQM2HPN_GO			1008 (2520)	General				470nH	4.7μH							1.1A to 1.8A
LQM2HPN_GC			1008 (2520)	General					1μH	4.7μH						800mA to 1.5A
LQM2HPN_GH			1008 (2520)	General				240nH	2.2μH							1.5A to 5A
LQM2HPN_GS			1008 (2520)	General					2.2μH	4.7μH						1A to 1.1A
LQM2HPN_J0			1008 (2520)	General					1μH	3.3μH						1A to 1.5A
LQM2HPN_JH			1008 (2520)	General				470nH	2.2μH							1.5A to 3.2A
LQM31PN_00			1206 (3216)	General				470nH	4.7μH							700mA to 1.4A
LQM32PN_GO			1210 (3225)	General					1μH							1.8A
LQM32PN_GC			1210 (3225)	General					1μH							2.2A
LQW15CN_00			0402 (1005)	General			18nH	200nH								390mA to 1.4A
LQW15CN_10	0402 (1005)		General			20nH	3.3μH								130mA to 2.2A	
LQW18CN_00	0603 (1608)		General			4.9nH	650nH								430mA to 2.6A	
LQH2MNC_02	0806 (2016)		General					1μH	82μH						90mA to 485mA	
LQH2MNC_52	0806 (2016)		General					1μH	22μH						130mA to 595mA	
LQH2MPN_GR	0806 (2016)		General				330nH	82μH							210mA to 2.2A	
LQH2HPN_GR	1008 (2520)		General				470nH	100μH							210mA to 2.9A	
LQH2HPN_JR	1008 (2520)		General				470nH	22μH							540mA to 3.5A	
DEM2812C	1211 (3028)		General				470nH	12μH							760mA to 3.1A	
DEM2815C	1211 (3028)		General				470nH	15μH							800mA to 3.9A	
DEM2818C	1211 (3028)		General				470nH	12μH							1A to 4.7A	
LQH3NPN_GR	1212 (3030)	General				470nH	250μH							140mA to 2.82A		

Continued on the following page. ↗

Inductors (Coils)

Inductors (Coils)

Series	Structure	Size Code inch (mm)	Applications	Inductance (H)										Rated Current Range	
				0.1n	1n	10n	100n	1μ	10μ	100μ	1m	10m			
LQH3NPN_JR	Wire Wound Ferrite Core Type	1212 (3030)	General					680nH			47μH				570mA to 2.86A
LQH3NPN_ME		1212 (3030)	General					1μH			100μH				430mA to 3A
LQH3NPN_MR		1212 (3030)	General					1μH			47μH				460mA to 2.15A
LQH31CN_03		1206 (3216)	General					120nH			100μH				80mA to 970mA
LQH32CN_23		1210 (3225)	General					1μH			560μH				60mA to 800mA
LQH32CN_33		1210 (3225)	General					150nH			10μH				450mA to 1.45A
LQH32CN_53		1210 (3225)	General					1μH			100μH				100mA to 1A
LQH32DN_23		1210 (3225)	General					1μH			560μH				60mA to 800mA
LQH32DN_53		1210 (3225)	General					1μH			100μH				100mA to 1A
LQH32PB_NO		1210 (3225)	General					470nH			120μH				200mA to 3.4A
LQH32PB_NC		1210 (3225)	General					470nH			22μH				650mA to 4.4A
LQH32PN_NO		1210 (3225)	General					470nH			120μH				200mA to 3.4A
LQH32PN_NC		1210 (3225)	General					470nH			22μH				650mA to 4.4A
DEM3512C		1514 (3735)	General					680nH			22μH				530mA to 2.5A
DEM3518C		1514 (3735)	General					560nH			22μH				880mA to 3.4A
LQH44PN_GR		1515 (4040)	General					680nH			47μH				410mA to 2.5A
LQH44PN_JO		1515 (4040)	General					1μH			47μH				380mA to 2A
LQH44PN_PO		1515 (4040)	General					1μH			22μH				800mA to 2.95A
LQH43CN_03		1812 (4532)	General					1μH			470μH				90mA to 1.08A
LQH43CN_33		1812 (4532)	General					560nH			3.9μH				1.6A to 2.95A
LQH43PB_26		1812 (4532)	General					1μH			220μH				240mA to 3.4A
LQH43PN_26		1812 (4532)	General					1μH			220μH				240mA to 3.4A
DEM4518C		1818 (4745)	General					1.2μH			22μH				1A to 3.5A
LQH5BPB_TO		2020 (5050)	General					470nH			22μH				1.4A to 7.7A
LQH5BPN_38		2020 (5050)	General					1μH			150μH				650mA to 7A
LQH5BPN_TO		2020 (5050)	General					470nH			22μH				1.4A to 7.7A
D52LC		2020 (5252)	General					1.2μH			100μH				260mA to 2.44A
D53LC <small>High Current</small>		2020 (5252)	General					1.1μH			100μH				460mA to 3.87A
D53LC <small>Low Rdc</small>		2020 (5252)	General					4.7μH			220μH				350mA to 2.31A
LQH55DN_03		2220 (5750)	General					120nH					10mH		50mA to 6A
DG6045C		2424 (6060)	General					1μH			100μH				900mA to 9.5A
DG6050C		2424 (6060)	General					1.2μH			100μH				1.2A to 9.8A
D63LCB		2524 (6362)	General					1μH			150μH				440mA to 4.52A
LQH66SN_03		2525 (6363)	General					270nH					10mH		50mA to 6A
DS75LC		2929 (7373)	General					1μH			470μH				430mA to 9.2A
DEM8030C		3131 (8080)	General					1.5μH			47μH				1.3A to 7.5A
DEM8040C		3131 (8080)	General					1.5μH			33μH				2.4A to 10A
DEM8045C		3131 (8080)	General					1.5μH			47μH				2.1A to 11.2A
DG8040C		3131 (8080)	General					1μH			100μH				1.3A to 10.4A
DEM10050C		3939 (100100)	General					1.5μH			33μH				3.5A to 15.3A
DS104C2		4040 (101101)	General					1.1μH			120μH				970mA to 11.7A
DS106C2		4040 (101101)	General					1.2μH			330μH				690mA to 12A
DS126C2		4949 (125125)	General					1.7μH			680μH				580mA to 11.8A
DFE201208S		Wire Wound Metal Alloy Core Type	0805 (2012)	General					470nH		2.2μH				1.8A to 4A
DFE201210S			0805 (2012)	General					470nH		2.2μH				2.1A to 4.8A
DFE201210U	0805 (2012)		General					240nH		2.2μH				2A to 6.5A	
DFE201610C	0806 (2016)		General					560nH		2.2μH				1.5A to 2.8A	
DFE201610E	0806 (2016)		General					240nH		10μH				1A to 6.3A	
DFE201610P	0806 (2016)		General					240nH		2.2μH				2A to 5.4A	
DFE201610R	0806 (2016)		General					470nH		2.2μH				1.6A to 3A	
DFE201612C	0806 (2016)		General					470nH		2.2μH				1.6A to 3.4A	
DFE201612E	0806 (2016)		General					330nH		4.7μH				1.8A to 6.3A	
DFE201612P	0806 (2016)		General					240nH		2.2μH				2.1A to 6.5A	
DFE201612R	0806 (2016)		General					470nH		2.2μH				1.7A to 3.5A	
DFE252007F	1008 (2520)		General					470nH		4.7μH				1.2A to 3.3A	
DFE252008C	1008 (2520)		General					470nH		4.7μH				1.1A to 3A	
DFE252010C	1008 (2520)		General					470nH		10μH				1A to 3.5A	

Continued on the following page. ↗

Inductors (Coils)

Series	Structure	Size Code inch (mm)	Applications	Inductance (H)										Rated Current Range	
				0.1n	1n	10n	100n	1μ	10μ	100μ	1m	10m			
DFE252010F	Wire Wound Metal Alloy Core Type	1008 (2520)	General				330nH	10μH							1.3A to 6.8A
DFE252010P		1008 (2520)	General				330nH	4.7μH							1.7A to 5.7A
DFE252010R		1008 (2520)	General					1μH	4.7μH						1.4A to 3A
DFE252012C		1008 (2520)	General				470nH	10μH							1A to 3.8A
DFE252012F		1008 (2520)	General				330nH	10μH							1.4A to 7.6A
DFE252012P		1008 (2520)	General				330nH	4.7μH							2A to 6.6A
DFE252012R		1008 (2520)	General					1μH	4.7μH						1.7A to 3.4A
DFE322510C		1210 (3225)	General				470nH	10μH							1A to 3.8A
DFE322512C		1210 (3225)	General				470nH	10μH							1.2A to 4.7A
DFE322512F		1210 (3225)	General				470nH	10μH							1.7A to 6.7A
FDS0412		1515 (4040)	General				330nH	4.7μH							2.5A to 7.5A
FDS0415		1515 (4040)	General				220nH	4.7μH							2.9A to 12A
FDS0420		1515 (4040)	General				470nH	330μH							2.5A to 11A
FDS0512		2019 (5249)	General					1μH	6.8μH						2.3A to 6.1A
FDS0515		2019 (5249)	General					1μH	4.7μH						3.2A to 7A
FDS0518		2019 (5249)	General					680nH	10μH						2.7A to 9A
FDV0530		2322 (5856)	General				110nH	4.7μH							3.6A to 19.6A
FCUL0530		2322 (5857)	General				360nH	470nH							16A to 18A
FCUL0624		2726 (6866)	General				220nH	470nH							17A to 24A
FCUL0630		2726 (6866)	General				120nH	680nH							15A to 32A
FDUE0640		2726 (6967)	General				150nH	420nH							22A to 33A
FDUE0650		2726 (6967)	General				600nH	1μH							16A to 18A
FDV0618		2726 (6967)	General				240nH	3.3μH							4.1A to 14A
FDV0620		2726 (6967)	General				200nH	4.7μH							3.5A to 16.2A
FDVE0630		2726 (6967)	General				160nH	10μH							3.1A to 20.7A
FDS0630		2726 (7066)	General				680nH	10μH							5.4A to 17A
FCUL1040		4239 (106100)	General				180nH	420nH							34A to 53A
FCUL1060		4239 (106100)	General				360nH	560nH							34A to 41A
FDUE1040D		4239 (106100)	General				220nH	1μH							18A to 32A
FDVE1040		4239 (106100)	General					1.5μH	10μH						6.1A to 14.6A
FDA1055		4242 (108108)	General				560nH	5.6μH							8A to 27.7A
FDUE1245		4848 (123121)	General				500nH	2.2μH							17A to 30A
FDA1254	5049 (126125)	General				680nH	8μH							9.1A to 29.1A	
FDUE1260	5050 (127127)	General				450nH								42A	

Inductors for General Circuits

Series	Structure	Size Code inch (mm)	Applications	Inductance (H)										Rated Current Range	
				0.1n	1n	10n	100n	1μ	10μ	100μ	1m	10m			
LQB15NN_10	Multilayer Type	0402 (1005)	General				220nH	560nH							300mA to 380mA
LQB18NN_10		0603 (1608)	General				220nH	560nH							300mA to 450mA
LQM18NN_00		0603 (1608)	General				47nH	2.2μH							15mA to 50mA
LQM21NN_10		0805 (2012)	General				100nH	4.7μH							30mA to 250mA
LLB2520	Wire Wound Ferrite Core Type	1008 (2520)	General					1μH	47μH						100mA to 480mA
LLM2520		1008 (2520)	General				100nH	220μH							44mA to 570mA
LQH31HN_03		1206 (3216)	General				54nH	880nH							180mA to 920mA
LQH31MN_03		1206 (3216)	General				150nH	100μH							45mA to 250mA
LLM3225		1210 (3225)	General				100nH	1mH							19mA to 600mA
LQH32MN_23		1210 (3225)	General					1μH	560μH						40mA to 445mA
LQH44NN_03		1515 (4040)	General				510nH	470μH							145mA to 4.5A
LQH43MN_03		1812 (4532)	General					1μH	1.5mH						40mA to 500mA
LQH43NN_03		1812 (4532)	General					1μH	2.4mH						25mA to 500mA
LQW04CA_00		03019 (0805)	General				60nH	510nH							200mA to 620mA
LQW15CA_00		0402 (1005)	General				22nH	2μH							130mA to 1.3A

Continued on the following page. ↗

RF Inductors

Series	Structure	Size Code inch (mm)	Applications	Inductance (H)										Rated Current Range		
				0.1n	1n	10n	100n	1μ	10μ	100μ	1m	10m				
LQG15HN_02	Multilayer Type	0402 (1005)	General		1nH				120nH						150mA to 1A	
LQG15HS_02		0402 (1005)	General		1nH				270nH						110mA to 1A	
LQG18HN_00		0603 (1608)	General		1.2nH				100nH						350mA to 1.1A	
LQW21HN_00	Wire Wound Ferrite Core Type	0805 (2012)	General					470nH		2.2μH					75mA to 160mA	
LQP02HQ_02	Film Type	01005 (0402)	General	0.2nH				56nH							100mA to 1A	
LQP02TN_02		01005 (0402)	General	0.2nH				39nH							90mA to 320mA	
LQP02TQ_02		01005 (0402)	General	0.2nH				22nH							120mA to 990mA	
LQP03HQ_02		0201 (0603)	General	0.6nH				150nH							80mA to 1.1A	
LQP03PN_02		0201 (0603)	General		2.2nH		4.7nH								900mA to 1.4A	
LQP03TG_02		0201 (0603)	General	0.1nH				120nH							80mA to 850mA	
LQP03TN_02		0201 (0603)	General	0.6nH				270nH							60mA to 850mA	
LQP03TQ_02		0201 (0603)	General	0.6nH				13nH							250mA to 1A	
LQP15MN_02		0402 (1005)	General		1nH			33nH							60mA to 400mA	
LQP18MN_02		0603 (1608)	General		1.3nH			100nH							50mA to 300mA	
LQW03AW_00		Wire Wound Non-Magnetic Core Type	0201 (0603)	General		1nH			15.5nH							230mA to 900mA
LQW04AN_00			03015 (0804)	General		0.8nH			33nH							140mA to 1.8A
LQW04AN_10			03015 (0804)	General					36nH		56nH					180mA to 200mA
LQW15AN_00	0402 (1005)		General		1.5nH			120nH							110mA to 1A	
LQW15AN_10	0402 (1005)		General		1.3nH			8.4nH							640mA to 1.2A	
LQW15AN_80	0402 (1005)		General		1.3nH			75nH							320mA to 3.15A	
LQW18AN_00	0603 (1608)		General		2.2nH			470nH							75mA to 850mA	
LQW18AN_10	0603 (1608)		General		2.2nH			33nH							550mA to 1.4A	
LQW18AN_80	0603 (1608)		General		2.2nH			390nH							190mA to 3.2A	
LQW18AS_00	0603 (1608)		General		1.6nH			390nH							100mA to 700mA	
LQW2BAN_00	0805 (2015)		General		3.2nH			200nH							750mA to 3.8A	
LQW2BAS_00	0805 (2015)		General		2.8nH			820nH							180mA to 800mA	
LQW2BHN_03	0805 (2015)		General		3.3nH			470nH							160mA to 1.32A	
LQW2BHN_13	0805 (2015)		General		2.7nH			27nH							900mA to 1.9A	
LQW2UAS_00	1008 (2520)		General				12nH				4.7μH				260mA to 1A	
LQW31HN_03	1206 (3216)		General				8.8nH			100nH					230mA to 750mA	

Inductors (Coils)

Inductors (Coils)

Automotive

Inductors for Power Lines

Inductors (Coils)

Series	Structure	Size Code inch (mm)	Applications	Inductance (H)										Rated Current Range	
				0.1n	1n	10n	100n	1μ	10μ	100μ	1m	10m			
LQM18PZ_CH	Multilayer Type	0603 (1608)	Infotainment					1μH	2.5μH						750mA to 950mA
LQM18PZ_DH		0603 (1608)	Infotainment					2.2μH							650mA
LQM18PZ_FH		0603 (1608)	Infotainment					2.2μH							700mA
LQM21PH_GC		0805 (2012)	Powertrain					2.2μH							800mA
LQM21PZ_CO		0805 (2012)	Infotainment				470nH	2.2μH							600mA to 1.1A
LQM21PZ_GO		0805 (2012)	Infotainment				470nH	3.3μH							800mA to 1.3A
LQM21PZ_GC		0805 (2012)	Infotainment				1μH	2.2μH							800mA to 900mA
LQM21PZ_GR		0805 (2012)	Infotainment				1μH	4.7μH							800mA to 1.3A
LQM2MPZ_GO		0806 (2016)	Infotainment				470nH	4.7μH							1.1A to 1.6A
LQM2HPZ_E0		1008 (2520)	Infotainment				560nH								1.5A
LQM2HPZ_GO		1008 (2520)	Infotainment				470nH	4.7μH							1.1A to 1.8A
LQM2HPZ_GC		1008 (2520)	Infotainment				1μH	4.7μH							800mA to 1.5A
LQM2HPZ_GS		1008 (2520)	Infotainment				2.2μH	4.7μH							1A to 1.1A
LQM2HPZ_J0		1008 (2520)	Infotainment				1μH	3.3μH							1A to 1.5A
LQW15CN_OZ		Wire Wound Ferrite Core Type	0402 (1005)	Infotainment			18nH	200nH							390mA to 1.4A
LQW15CN_1Z	0402 (1005)		Infotainment			20nH	560nH							300mA to 2.2A	
LQH2MPZ_GR	0806 (2016)		Infotainment				330nH	82μH						210mA to 2.2A	
LQH2HPZ_GR	1008 (2520)		Infotainment				470nH	22μH						460mA to 2.9A	
LQH2HPZ_JR	1008 (2520)		Infotainment				470nH	22μH						540mA to 3.5A	
LQH3NPZ_GR	1212 (3030)		Infotainment				470nH	47μH						460mA to 2.82A	
LQH3NPZ_JR	1212 (3030)		Infotainment				680nH	47μH						570mA to 2.86A	
LQH3NPZ_ME	1212 (3030)		Infotainment				1μH	100μH						430mA to 3A	
LQH32CH_23	1210 (3225)		Powertrain				1μH	22μH						250mA to 800mA	
LQH32CH_33	1210 (3225)		Powertrain				150nH	10μH						450mA to 1.45A	
LQH32CH_53	1210 (3225)		Powertrain				1μH	22μH						250mA to 1A	
LQH32DZ_23	1210 (3225)		Infotainment				1μH	470μH						60mA to 800mA	
LQH32DZ_53	1210 (3225)		Infotainment				1μH	100μH						100mA to 1A	
LQH32PH_NO	1210 (3225)		Powertrain				470nH	10μH						750mA to 3.4A	
LQH32PH_NC	1210 (3225)		Powertrain				470nH	22μH						650mA to 4.4A	
LQH32PZ_NO	1210 (3225)		Infotainment				470nH	120μH						200mA to 3.4A	
LQH32PZ_NC	1210 (3225)		Infotainment				470nH	22μH						650mA to 4.4A	
LQH44PZ_GR	1515 (4040)		Infotainment				680nH	47μH						410mA to 2.5A	
LQH43PH_26	1812 (4532)		Powertrain				1μH	220μH						240mA to 3.4A	
LQH43PZ_26	1812 (4532)		Infotainment				1μH	220μH						240mA to 3.4A	
LQH5BPZ_TO	2020 (5050)		Infotainment				470nH	22μH						1.4A to 7.7A	
MBH6045C	High Current Low Rdc		2424 (6262)	Powertrain			1.5μH	47μH						1.1A to 6.3A	
MBH6045C			2424 (6262)	Powertrain				1μH	470μH					410mA to 4.4A	
MBH7045C	High Current Low Rdc		2828 (7272)	Powertrain				22μH	220μH					550mA to 1.8A	
MBH7045C			2828 (7272)	Powertrain				3.3μH	220μH					650mA to 3.5A	
MBH10145C			4141 (104104)	Powertrain				5.6μH	220μH					850mA to 4.1A	
MBH12282C			4949 (125125)	Powertrain				6.8μH	1mH					590mA to 7A	
MBH12575C			5050 (128128)	Powertrain				10μH	220μH					1.2A to 5.2A	
DFE252012P	Wire Wound Metal Alloy Core Type		1008 (2520)	Infotainment			330nH	4.7μH						1.9A to 6A	
DFEH7030D			2726 (7066)	Powertrain				1μH	22μH					2A to 9.1A	
DFEH7030D			2726 (7066)	Powertrain				1μH	22μH					2A to 9.1A	
DFEH10040D			4339 (109100)	Powertrain				1μH	22μH					4A to 18A	
DFEH10040D			4339 (109100)	Powertrain				1μH	22μH					4A to 18A	
DFEH12060D		5150 (130126)	Powertrain				1μH	22μH					6A to 20A		
DFEH12060D		5150 (130126)	Powertrain				1μH	22μH					6A to 20A		

Continued on the following page. ↗

Inductors for General Circuits

Series	Structure	Size Code inch (mm)	Applications	Inductance (H)										Rated Current Range	
				0.1n	1n	10n	100n	1μ	10μ	100μ	1m	10m			
LQH31HZ_03	Wire Wound Ferrite Core Type	1206 (3216)	Infotainment				54nH		880nH						180mA to 920mA
LQH43NZ_03		1812 (4532)	Infotainment					1μH				2.2mH			30mA to 500mA
HEAWS		4241 (107104)	Infotainment						10μH						5A
HEAW		5551 (140130)	Infotainment						10μH						7.2A

RF Inductors

Series	Structure	Size Code inch (mm)	Applications	Inductance (H)										Rated Current Range	
				0.1n	1n	10n	100n	1μ	10μ	100μ	1m	10m			
LQG15HH_02	Multilayer Type	0402 (1005)	Powertrain		1nH			270nH							110mA to 1A
LQG15HZ_02		0402 (1005)	Infotainment		1nH			270nH							110mA to 1A
LQG15WH_02		0402 (1005)	Powertrain		1nH		15nH								400mA to 1.2A
LQG15WZ_02		0402 (1005)	Infotainment		1nH		15nH								400mA to 1.2A
LQG18HH_00	Film Type	0603 (1608)	Powertrain		1.2nH			270nH							200mA to 1.1A
LQP03TN_Z2		0201 (0603)	Infotainment		0.6nH			120nH							80mA to 850mA
LQW15AN_0Z	Wire Wound Non-Magnetic Core Type	0402 (1005)	Infotainment		1.5nH			120nH							110mA to 1A
LQW15AN_1Z		0402 (1005)	Infotainment		1.3nH		8.4nH								640mA to 1.2A
LQW15AN_8Z		0402 (1005)	Infotainment		1.3nH			75nH							320mA to 3.15A
LQW18AN_0Z		0603 (1608)	Infotainment		2.2nH			470nH							75mA to 850mA
LQW18AN_1Z		0603 (1608)	Infotainment		2.2nH			33nH							550mA to 1.4A
LQW18AN_8Z		0603 (1608)	Infotainment		2.2nH			390nH							190mA to 3.2A
LQW18AS_0Z		0603 (1608)	Infotainment		1.6nH			390nH							100mA to 700mA

Effective Use of Power Inductors

The product group of Murata's inductors for power circuits consists of the wire wound type and the monolithic type. For the applications of power inductors, Murata has prepared the "Murata Power Inductor Selection Tool," which can calculate and display the performance of inductors based on actual use conditions.

The type of application where single or multiple power inductors are used can have an effect on the efficiency of the part(s). Core losses are suffered depending on the Temperature, Frequency, and Current needed for the application. Using the "Murata Power Inductor Selection Tool," you can input the needed Temperature, Frequency, and Current for the application and easily select a usable part.

URL: <http://www.murata.com/products/inductor/chip/learn/apply/power>

Detailed Catalogs

For more details, please refer to our printed catalogs and the PDF catalogs on our website.



- Chip Inductors (Chip Coils) Cat. No. O05E
- EMI Suppression Filters (for DC)/Chip Inductors for Automotive Cat. No. C51E

Resistors

Full lineup for various applications

Summary

Using Murata's ceramic processing technology and unique materials, we offer a series of resistor products.

Lineup

- High Voltage Resistors



High Voltage Resistors

Featuring thick-film resistors, the Murata MHR series of high-voltage resistors is available in compact and thin SIP packages. Variants with small deviations are also available on request.

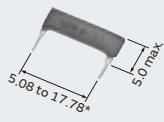

MHR03 Series

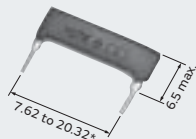

MHR04 Series

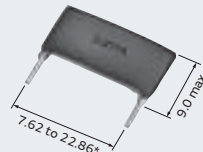

MHR06 Series

(in mm)

*The terminal pitch is an integral multiple of 2.54mm.

Series	Resistance (min.) (MΩ)	Resistance (max.) (MΩ)	Maximum Operating Voltage (Single Use) (kV)	Maximum Operating Voltage (Molded Use) (kV)	Rated Power (W)
MHR03	1	500 to 1000	2 to 8	3 to 14	0.3 to 1.0
MHR04	1	1000	3.5 to 9	10 to 16	0.6 to 1.3
MHR06	1	1000	3.5 to 10	10 to 20	0.8 to 1.6

Resistance 2 element type is also available.
For resistance value and ratio, please contact us.

Timing Devices

A stable timing source for microprocessors in various electronic devices

Summary

Murata's ceramic processing technology and unique piezoelectric material has led to the development of a range of small and thin ceramic timing devices that offer high oscillation frequency and remarkable oscillation tolerance.

Lineup

- Crystal Units ●Crystal Oscillators
- Ceramic Resonators CERALOCK®



IC Part Number - Timing Devices Search

Search for Timing Devices by IC part number or search for IC part number by Timing Devices on our website. It is also possible to search by either oscillating frequency or frequency range.

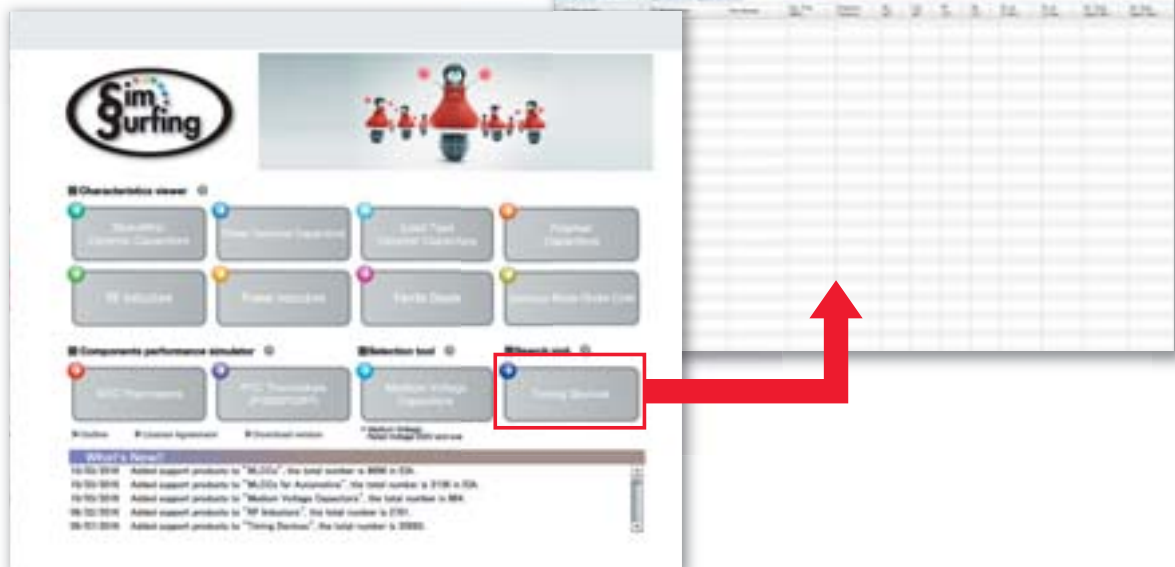

<http://www.murata.com/simsurfing/>

Detailed Catalogs

For more details, please refer to our printed catalogs and the PDF catalogs on our website.



- Ceramic Resonators (CERALOCK®)
- Ceramic Resonator (CERALOCK®) Application Manual
- Crystal Units/Crystal Oscillators

- Cat. No. P16E
- Cat. No. P17E
- Cat. No. P79E

Crystal Units

Crystal Units utilize highly accurate frequency-based high-grade quartz crystal elements. We offer a wide lineup of Crystal Units using Murata's proven package technology for small digital devices, automotive, etc.

For Automotive

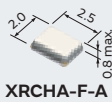

(in mm)

Series	Type	Seal	Frequency (MHz)												Frequency Shift by Temperature (ppm max.)	Operating Temperature Range (°C)									
			1	2	3	4	5	6	7	8	9	10	20	30			40	50	70	100					
XRCHA-F-A	HCR2520	Resin												16.0000±100ppm	24.0000±100ppm								±100	-40 to 125	
XRCGB-F-A	HCR2016	Resin												24.0000±30ppm	29.9999±30ppm									±35	-40 to 125
														30.0000±50ppm	48.0000±50ppm									±65	-40 to 125

For Consumer/Industrial

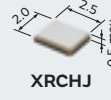
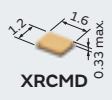

(in mm)

Series	Type	Seal	Frequency (MHz)												Frequency Shift by Temperature (ppm max.)	Operating Temperature Range (°C)									
			1	2	3	4	5	6	7	8	9	10	20	30			40	50	70	100					
XRCFD	MCR1612	Metal												24.0000±10ppm	29.9999±10ppm								±10	-20 to 70	
XRCMD	MCR1612	Metal												30.0000±10ppm	48.0000±10ppm									±10	-20 to 70
XRCGB-F-H	HCR2016	Resin												24.0000±10ppm	25.0000±10ppm									±10	-20 to 70
														26.0000±10ppm	32.0000±10ppm									±10	-30 to 85
XRCGB-F-P	HCR2016	Resin												24.0000±20ppm	32.0000±20ppm									±20	-30 to 85
XRCGB-F-M	HCR2016	Resin												24.0000±30ppm	32.0000±30ppm									±40	-30 to 85
														33.8688±45ppm	50.0000±45ppm									±40	-30 to 85
XRCGB-F-L	HCR2016	Resin												24.0000±100ppm	50.0000±100ppm									±50	-30 to 85
XRCGB-F-Z	HCR2016	Resin												24.0000±100ppm	50.0000±100ppm									±100	-40 to 105
XRCHH	TAS-2520F	Metal												16.0000±10ppm	52.0000±10ppm									±15	-30 to 85
XRCHJ	TDS-2520F	Seam												16.0000±10ppm	52.0000±10ppm									±15	-30 to 85
XRCHA-F-L	HCR2520	Resin												16.0000±100ppm	20.0000±100ppm									±100	-30 to 85
XRCHA-F-Z	HCR2520	Resin												16.0000±100ppm	20.0000±100ppm									±100	-40 to 105
XRCJH	TAS-3225J	Metal												13.0000±10ppm	52.0000±10ppm									±15	-30 to 85
XRCJK	TSS-3225J	Seam												12.0000±10ppm	52.0000±10ppm									±15	-30 to 85
XRCLH	TAS-5032F	Metal												10.0000±10ppm	52.0000±10ppm									±15	-30 to 85
XRCLK	TSS-5032A	Seam												10.0000±10ppm	52.0000±10ppm									±15	-30 to 85

Crystal Oscillators

We offer a varied lineup of Crystal Oscillators using highly reliable crystal units, circuit engineering, superior temperature compensation methods, and measurement furthered by our long experience and expertise.

For Consumer/Industrial

Series	Type	VC Function	Frequency (MHz)										Frequency Shift by Temperature (ppm max.)	Frequency Aging (ppm max./year)	Operating Temperature Range (°C)		
			1	5	10	20	30	40	50	70	100						
XNCHH	TTS27NSC-A7	-	10.0000±1ppm											52.0000±1ppm	±0.5	±1.0	-30 to 85
XNCJH	TTS18NSH-A7	-	10.0000±1ppm											52.0000±1ppm	±0.5	±1.0	-30 to 85
XTCHH	TTS27VSC-A7	●	10.0000±1ppm											52.0000±1ppm	±0.5	±1.0	-30 to 85
XTCJH	TTS18VSH-A7	●	10.0000±1ppm											52.0000±1ppm	±0.5	±1.0	-30 to 85
XTCLH_J	TTS14VSH	●	10.0000±0.5ppm											40.0000±0.5ppm	±0.28	±0.5	-40 to 85

Ceramic Resonators CERALOCK®

Wide product lineup for automotive and consumer applications with SMD and leaded packages.

MHz Chip Type for Automotive (Tight Frequency Tolerance)

Series	Frequency (MHz)										Frequency Shift by Temperature (% max.)	Operating Temperature Range (°C)							
	1	2	3	4	5	6	7	8	9	10			20	30	40	50	70	100	
CSTCR_G15C		4.00±0.1%								7.99±0.1%								±0.13	-40 to 125
CSTCE_G15C				8.00±0.1%							13.99±0.1%							±0.13	-40 to 125
CSTCE_V13C										14.00±0.1%				20.00±0.1%				±0.13	-40 to 125

MHz Chip Type for Automotive (Standard Frequency Tolerance)

Series	Frequency (MHz)										Frequency Shift by Temperature (% max.)	Operating Temperature Range (°C)							
	1	2	3	4	5	6	7	8	9	10			20	30	40	50	70	100	
CSTCC_G_A	2.00±0.5%									3.99±0.5%								±0.4 (15pF) -0.6/+0.3 (47pF)	-40 to 125
CSTCR_G_B		4.00±0.5%									7.99±0.5%							±0.15	-40 to 125
CSTCE_G_A				8.00±0.5%								13.99±0.5%						±0.2	-40 to 125
CSTCE_V_C										14.00±0.5%				20.00±0.5%				±0.15	-40 to 125

MHz Chip Type for Consumer Electronics (Tight Frequency Tolerance)



Series	Frequency (MHz)											Frequency Shift by Temperature (% max.)	Operating Temperature Range (°C)					
	1	2	3	4	5	6	7	8	9	10	20			30	40	50	70	100
CSTCR_G15L		4.00±0.1%								7.99±0.1%							±0.08	0 to 70
CSTCE_G15L			8.00±0.1%							13.99±0.1%							±0.08	0 to 70
CSTCE_V13L				14.00±0.1%						20.00±0.1%							±0.08	0 to 70
CSTCW_X11										20.01±0.1%					48.00±0.1%		±0.1	0 to 70

MHz Chip Type for Consumer Electronics (Standard Frequency Tolerance)

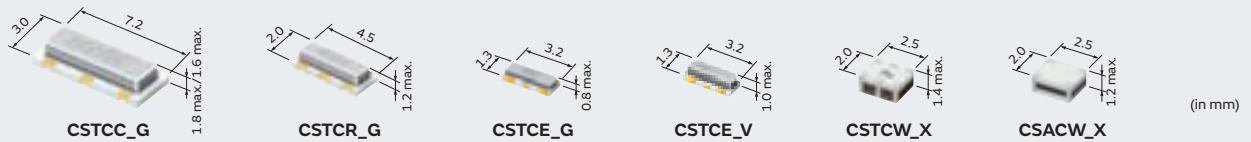

Series	Frequency (MHz)											Frequency Shift by Temperature (% max.)	Operating Temperature Range (°C)					
	1	2	3	4	5	6	7	8	9	10	20			30	40	50	70	100
CSTCC_G	2.00±0.5%									3.99±0.5%							±0.3 (15pF) ±0.4 (47pF)	-20 to 80
CSTCR_G		4.00±0.5%								7.99±0.5%							±0.2	-20 to 80
CSTCE_G			8.00±0.5%							13.99±0.5%							±0.2	-20 to 80
CSTCE_V				14.00±0.5%						20.00±0.5%							±0.3	-20 to 80
CSTCW_X										20.01±0.5%					70.00±0.5%		±0.2	-20 to 80
CSACW_X (No built-in load capacitance)										20.01±0.5%					70.00±0.5%		±0.2	-20 to 80

MHz Lead Type for Consumer Electronics (Standard Frequency Tolerance)

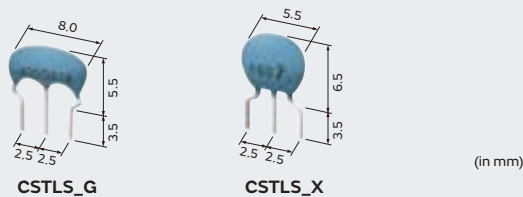

Series	Frequency (MHz)											Frequency Shift by Temperature (% max.)	Operating Temperature Range (°C)					
	1	2	3	4	5	6	7	8	9	10	20			30	40	50	70	100
CSTLS_G		3.40±0.5%								10.00±0.5%							±0.2 (15pF) -0.4/+0.2 (47pF)	-20 to 80
CSTLS_X										16.00±0.5%					70.00±0.5%		±0.2	-20 to 80

Filters

Broad lineup of Filters for video, audio, RF/Local, Duplexers, and Filters for IF

Summary

Using Murata's ceramic processing technology and unique materials, we offer miniaturized filters with excellent properties for advanced digital audio/visual systems and communication equipment.

Lineup

- Ceramic Filters CERAFIL® (Filters, Traps, and Discriminators)
- Crystal Filters ● SAW Filters for Mobile Communications
- Dielectric Filters GIGAFIL® ● Chip Multilayer LC Filters



Ceramic Filters CERAFIL®

CERAFIL® 10.7MHz Chip Type

Small and lightweight filters for IF in communications or AV equipment using unique piezoelectric material.

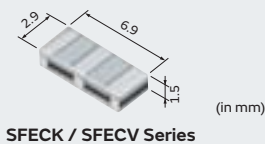

Type	Series	3dB Bandwidth (kHz)		
		E	J	K
		330	150	110
High-reliability Type	SFECK10M7□	-	●	●
Standard Type	SFECV10M7□	-	●	●
Standard Type	SFECV15M0□	●	-	-

□ is filled with the letter designating the required 3dB bandwidth.



Type	Series	3dB Bandwidth (kHz)				
		D	E	F	G	H
		350	330	280	230	180
Standard Type	SFECF10M7□	●	●	●	●	●

□ is filled with the letter designating the required 3dB bandwidth.

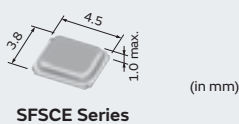

Type	Series	3dB Bandwidth (kHz) min.		
		03	04	05
		±500	±400	±325
Wide Bandwidth	SFSCE10M7WF□□	●	●	●

□ is filled with the letter designating the required 3dB bandwidth.

CERAFIL® 2.3 to 6.5MHz Chip Type

The SFSKA Series has distinctive features such as wide bandwidth and stable filter performance, enabling customers to design smaller products. The SFSKB Series is suitable for low frequency range.

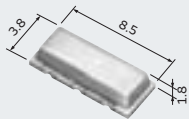

SFSKA Series



SFSKB Series

(in mm)

Series	Center Frequency (MHz)												3dB Bandwidth (kHz)
	2.3	2.8	3.2	3.8	4.3	4.5	4.8	5.2	5.5	5.7	6.0	6.5	
SFSKA	-	-	-	-	-	●	-	-	●	-	●	●	±60 min.
SFSKB	●	●	●	●	●	-	●	●	-	●	-	-	±75 min.

Ceramic Traps

The TPSKA Series has distinctive features such as high attenuation and high performance group delay time, enabling customers to design smaller products.

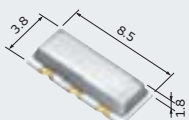

TPSKA Series

(in mm)

Series	Center Frequency (MHz)	Attenuation (dB)
TPSKA	4.500/5.500/6.000/6.500	35 min.

Ceramic Discriminators

In combination with ICs, this type obtains stable demodulation characteristics in a wide bandwidth.

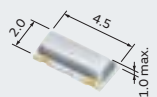

CDSCB Series

(in mm)

Series	Center Frequency
CDSCB	10.700MHz±30kHz

The recommended part number depends on IC specifications. Please contact us with the IC part number to be applied.

Crystal Filters

Our original wafer-thin technology has made it possible to make highly reliable filters in various applications such as radio communication worldwide.

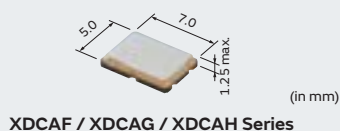

Series	Type	Frequency Range (MHz)	Number of Poles
XDCAF	TM7050F	20 to 80	2
XDCAG	TM7050G	[Fundamental] 70 to 150	4
XDCAH	TM7050H	[3rd overtone]	4

*Please be sure to consult with our sales representative or engineer if you require other center frequency.

SAW Filters for Mobile Communications

SAW Duplexers

Low loss, high attenuation performance, small size, highly selective pass band, chip size package



RF Filters

Low loss, high attenuation performance, small size, highly selective pass band, chip size package

Single Filter



Dual Filter

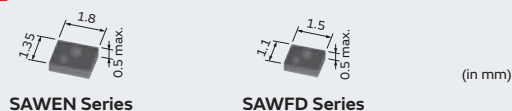

SAW Filters and SAW Duplexers must be used only in the following equipment:

Mobile phones, cordless telephones (except automobile telephone), smartphones, tablet PC, PC (including laptop/netPC), game machines, cameras (except for business use and for security), STB, electronic dictionaries, and digital audio instruments. Please contact us for other usages.

Dielectric Filters GIGAFIL®

Suitable for cellular base stations and other telecom infrastructure systems.
 Custom parts within the range below are available upon request.



DFYH Series

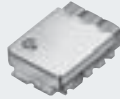

DFCH Series



TDF Series

	Series	Frequency Range (MHz)								Number of Resonators	Input Power Range
		100	1000	2000	3000	4000	5000	6000	7000		
Duplexers	DFYH	700	2600							5 to 10	1 to 10W*
RF/IF/Local Filter	DFCH	600	3800							2 to 6	1 to 10W*
RF/IF/Local Filter	TDF		2000	6000						2 to 5	1 to 10W*

*Power depends upon specifications.

Characteristic customization is available. You can also contact us through our website.

Chip Multilayer LC Filters

Ultra-small and low-profile filters based on ceramic multilayer technology.

Band Pass Filters

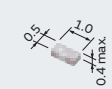

LFB15 Series

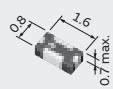

LFB18 Series

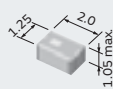

LFB21 Series

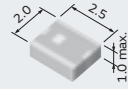

LFB2H Series

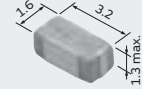

LFB31 Series

(in mm)

Low Pass Filters

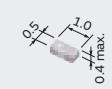

LFL15 Series

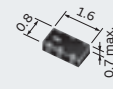

LFL18 Series



LFL21 Series

(in mm)

Detailed Catalogs

For more details, please refer to our printed catalogs and the PDF catalogs on our website.



- Ceramic Filters (CERAFIL®)/Crystal Filters
- Ceramic Filters (CERAFIL®) Application Manual

Cat. No. P51E

Cat. No. P11E

RF Components

Broad lineup of RF Components for RF/Local circuits in communications equipment

Summary

To enhance the technical advantages of communication equipment, Murata offers miniaturized, sophisticated components to meet the demands of many applications.

Lineup

- Antennas ●Isolators ●Baluns (Chip Multilayer and Wire Wound/Film type) ●Couplers (Chip Multilayer and Film type)
- Chip Multilayer Hybrid Dividers ●Chip Multilayer Diplexers
- Microwave Coaxial Connectors ●Single Layer Microchip Capacitors ●Thin Film Circuit Substrate RUSUB®



Antennas

Coil Antennas

Rx 1D-ANT

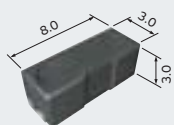

SA3M08 Series



SAZ73D Series

(in mm)

Series	Inductance (mH)	Q (Reference)
SA3M08	1.0 to 18.0	25
SAZ73D	1.0 to 9.0	30

Rx 3D-ANT

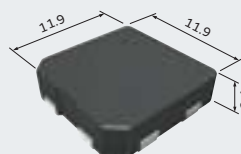

SA3D12 Series

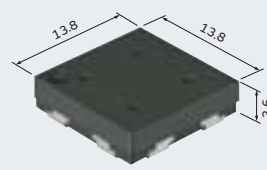

SA3D14 Series

(in mm)

Series		Inductance (mH)	Q (Reference)
SA3D12	X	1.0 to 6.3	20
	Y	1.0 to 6.3	20
	Z	1.0 to 9.0	20
SA3D14	X	1.0 to 6.3	20
	Y	1.0 to 6.3	20
	Z	1.0 to 9.0	20

Transmitter ANT

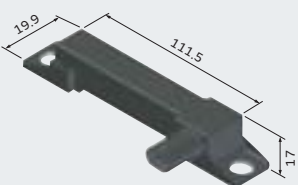

STA8121 Series

(in mm)

Series	Capacitance (pF)	Resonance Frequency
STA8121	2200 to 10000	125kHz, 134.2kHz

Isolators

Isolators pass signals in the forward direction and blocking signals in the reverse direction.

For Base Stations

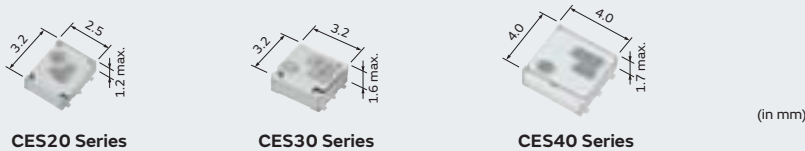

Series	Adaptive Frequency Range (MHz)				Size (mm)	Rating Power (W)
	100	1000	2000	3000		
CES20			1900 – 2600		3.2X2.5X1.2 max.	5 max.
CES30			1700 – 2200		3.2X3.2X1.6 max.	5 max.
CES40		800 – 950			4.0X4.0X1.7 max.	5 max.

RF Components

Baluns

SMD baluns constructed with a copper conductor and ceramic material. Ideal for high-frequency applications. Small-size and low-loss baluns can be customized for balance impedance of 50Ω to 200Ω.

Chip Multilayer Type



Film Type



Wire Wound Type

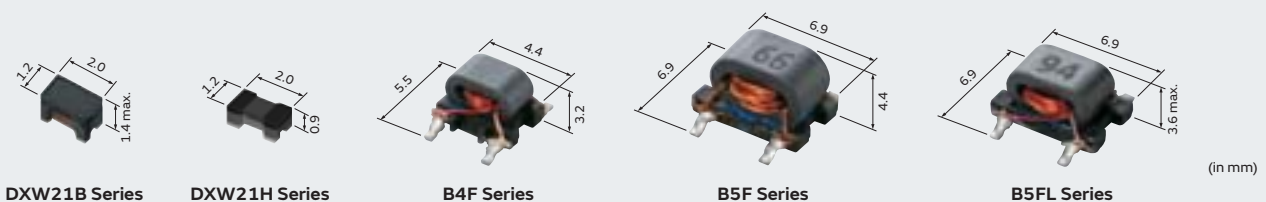

Couplers

An ultra-small, low-profile directional coupler based on ceramic multilayer technology. This coupler achieves ultra-small size, low insertion loss, and high isolation.

Chip Multilayer Type

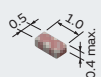

LDC15 Series
LDJ15 Series

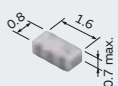

LDC18 Series
LDJ18 Series

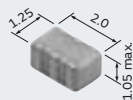

LDC21 Series
LDJ21 Series

(in mm)

*It is available with Integrated LPF for LDC21 Series.

Film Type

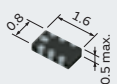

DXP18C Series

(in mm)

Chip Multilayer Hybrid Dividers

Power divider with a multilayer low pass filter in an ultra-compact package.

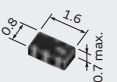

LDD18 Series

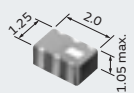

LDD21 Series

(in mm)

Chip Multilayer Diplexers

A diplexer branching low and high band. Suitable for band-switching for dual-band system.

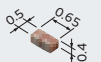

LFD15 Series

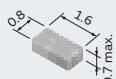

LFD18 Series

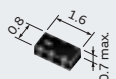

LFD21 Series

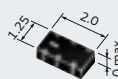
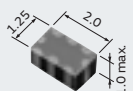

LFD2H Series

(in mm)

Microwave Coaxial Connectors

Microwave Coaxial Cable Connectors

The mating height is only 1.0mm maximum due to our new mechanical design. Suitable for low-profile design.



Type	Receptacle Part Number	Rated Voltage (Vrms)	Frequency Rating (GHz)	Temperature Range	Voltage Standing Wave Ratio	Cable Number	Mating Height (mm)
HSC	MM4829-2702	30	to 6	-40 to 85°C	1.3 max. (DC to 3GHz)	MXHP32_____	1.2 max.
JSC	MM5829-2700	30	to 12	-40 to 85°C	1.3 max. (DC to 3GHz)	MXJA01_____	1.0 max.
KSC	MM6829-2700	30	to 6	-40 to 85°C	1.3 max. (DC to 3GHz)	MXKGB3_____	0.8 max.
LSC	MM7829-2700	30	to 6	-40 to 85°C	1.3 max. (DC to 3GHz)	MXLAB3_____	0.8 max.

Nominal Impedance: 50Ω

Microwave Coaxial Connectors with Switch

The coaxial connector with switch is very useful for characteristic measurement in cellular phones and microwave circuits.

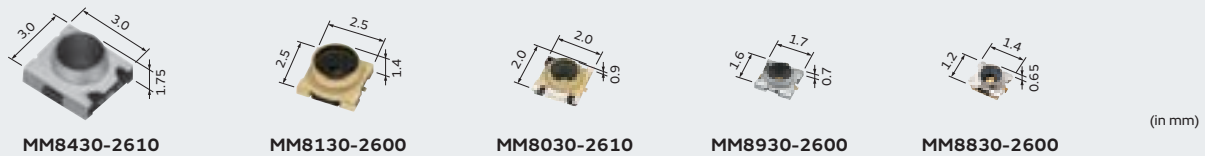

Type	Receptacle Part Number	Rated Voltage (Vrms)	Frequency Rating (GHz)	Temperature Range	Voltage Standing Wave Ratio	Standard Measurement Probe Part Number
SWD	MM8430-2610	30	to 6	-40 to 85°C	1.2 max. (DC to 3GHz)	MM126320
SWF	MM8130-2600	30	to 6	-40 to 85°C	1.2 max. (DC to 3GHz)	MXHS83QE3000
SWG	MM8030-2610	30	to 11	-40 to 85°C	1.2 max. (DC to 3GHz)	MM126320 MXHQ87WJ3000
SWH	MM8930-2600	30	to 6	-40 to 85°C	1.2 max. (DC to 3GHz)	MM126515 MXHQ87PA3000
SWJ	MM8830-2600	30	to 6	-40 to 85°C	1.2 max. (DC to 3GHz)	MM126715 MXHQ87PK3000

Nominal Impedance: 50Ω

Single Layer Microchip Capacitors

Very reliable performance and excellent frequency characteristics

Temperature Compensation Type

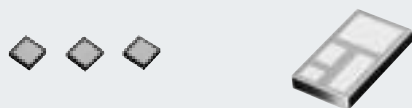

Capacitance Change (Temperature Range)	Series	Size (mm)	Rated Voltage (Vdc)	Capacitance Range at 25°C (pF)					Operating Temperature Range (°C)
				0.1	1	10	100	1000	
0±30ppm/°C (-25 to 85°C)	CLB0A	0.25X0.25	100	0.1					-55 to 125
	CLB0C	0.35X0.25	100	0.2					-55 to 125
	CLB0D	0.38X0.38	100	0.2	0.4				-55 to 125
	CLB05	0.5X0.5	100	0.3	0.6				-55 to 125
	CLB0E	0.55X0.38	100	0.5	0.6				-55 to 125
	CLB0F	0.64X0.64	100	0.3	1.0				-55 to 125
	CLB0G	0.7X0.5	100	0.7	1.0				-55 to 125
	CLB0H	0.71X0.38	100	0.7	0.8				-55 to 125
	CLB0J	0.76X0.76	100	0.4	1.3				-55 to 125
	CLB09	0.9X0.9	100	0.5	1.8				-55 to 125
	CLB1A	1.00X0.64	100	1.1	1.6				-55 to 125
	CLB1B	1.09X0.76	100	1.5	2.0				-55 to 125
	CLB1C	1.27X1.27	100	1.0	3.6				-55 to 125
	CLB1E	1.49X0.9	100	2.0	2.7				-55 to 125
	CLB1G	1.73X1.27	100	3.9	4.7				-55 to 125
	CLB1H	1.78X1.78	100	1.8	6.8				-55 to 125
	CLB2C	2.19X1.27	100	5.1					-55 to 125
	CLB2E	2.29X2.29	100	3.0	10				-55 to 125
	CLB2L	2.95X1.78	100	7.5	10				-55 to 125
	CLB3G	3.71X2.29	100	11	16				-55 to 125
-750±60ppm/°C (-25 to 85°C)	CLB0A	0.25X0.25	100	0.3	0.7				-55 to 125
	CLB0B	0.30X0.25	100	0.8					-55 to 125
	CLB0C	0.35X0.25	100	0.9					-55 to 125
	CLB0D	0.38X0.38	100	0.9	1.6				-55 to 125
	CLB05	0.5X0.5	100	1.0	2.4				-55 to 125
	CLB0E	0.55X0.38	100	1.8	2.4				-55 to 125
	CLB0F	0.64X0.64	100	2.0	4.3				-55 to 125
	CLB0G	0.7X0.5	100	2.7	3.0				-55 to 125
	CLB0H	0.71X0.38	100	2.7					-55 to 125
	CLB0J	0.76X0.76	100	3.0	6.2				-55 to 125
	CLB09	0.9X0.9	100	3.3	6.8				-55 to 125
	CLB1A	1.00X0.64	100	4.7	6.2				-55 to 125
	CLB1B	1.09X0.76	100	6.8	7.5				-55 to 125
	CLB1C	1.27X1.27	100	7.5	15				-55 to 125
	CLB1E	1.49X0.9	100	7.5	9.1				-55 to 125
	CLB1H	1.78X1.78	100	13	15				-55 to 125
CLB2E	2.29X2.29	100	20					-55 to 125	

All Single Layer Microchip Capacitors are produced after receiving an order.

High Dielectric Constant Type

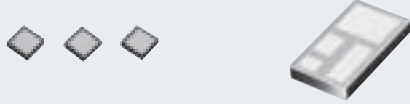

Capacitance Change (Temperature Range)	Series	Size (mm)	Rated Voltage (Vdc)	Capacitance Range at 25°C (pF)					Operating Temperature Range (°C)
				0.1	1	10	100	1000	
±10% (-25 to 85°C)	CLBOA	0.25X0.25	100			5.6 12			-55 to 125
	CLBOB	0.30X0.25	100			13 15			-55 to 125
	CLBOC	0.35X0.25	100			16 18			-55 to 125
	CLBOD	0.38X0.38	100			18 30			-55 to 125
	CLB05	0.5X0.5	100			22 43			-55 to 125
	CLBOE	0.55X0.38	100			33 43			-55 to 125
	CLBOF	0.64X0.64	100			43 75			-55 to 125
	CLBOG	0.7X0.5	100			47 68			-55 to 125
	CLBOH	0.71X0.38	100			47 56			-55 to 125
	CLBOJ	0.76X0.76	100			68 110			-55 to 125
	CLB09	0.9X0.9	100			68 130			-55 to 125
	CLB1A	1.00X0.64	100			82 120			-55 to 125
	CLB1C	1.27X1.27	100			160 200			-55 to 125
	CLB1E	1.49X0.9	100			150 160			-55 to 125
	CLB1G	1.73X1.27	100			300			-55 to 125
	CLB1H	1.78X1.78	100			300 430			-55 to 125
CLB2E	2.29X2.29	100			470 620			-55 to 125	
+30, -80% (-25 to 85°C)	CLBOA	0.25X0.25	100			27 33			-55 to 125
	CLBOB	0.30X0.25	100			36 39			-55 to 125
	CLBOC	0.35X0.25	100			43 51			-55 to 125
	CLBOD	0.38X0.38	100			62 82			-55 to 125
	CLB05	0.5X0.5	100			75 130			-55 to 125
	CLBOE	0.55X0.38	100			91 120			-55 to 125
	CLBOF	0.64X0.64	100			130 220			-55 to 125
	CLBOG	0.7X0.5	100			150 200			-55 to 125
	CLBOH	0.71X0.38	100			130 150			-55 to 125
	CLBOJ	0.76X0.76	100			200 300			-55 to 125
	CLB09	0.9X0.9	100			200 390			-55 to 125
	CLB1A	1.00X0.64	100			240 360			-55 to 125
+30, -90% (-25 to 85°C)	CLBOA	0.25X0.25	100			36 56			-55 to 125
	CLBOD	0.38X0.38	100			91 150			-55 to 125
	CLB05	0.5X0.5	100			130 220			-55 to 125
	CLBOF	0.64X0.64	100			220 390			-55 to 125
	CLBOJ	0.76X0.76	100			330 560			-55 to 125
	CLB09	0.9X0.9	100			390 680			-55 to 125

All Single Layer Microchip Capacitors are produced after receiving an order.

Detailed Catalogs

For more details, please refer to our printed catalogs and the PDF catalogs on our website.



• High Frequency Single Layer Microchip Capacitors

Cat. No. C01E

Thin Film Circuit Substrate RUSUB®

Suitable for photo diode modules.

■ Features

- RUSUB® technology provides a single-layer capacitor and thin film resistor formed in one chip. It reduces not only the number of parts to build a device, but also the assembly costs. It will also contribute to making a device smaller.
- The single-layer structure makes its self-resonant frequency higher. It allows stable operation even at a high frequency range.
- The short distance between the capacitor and thin film resistor makes the residue inductance smaller and contributes to attenuating unnecessary noise so the device can work at its best characteristics.
- Since it has a gold electrode, it is feasible to be installed inside a module, and it allows wire-bonding with gold wire.
- AuSn pre-coating finish is also available.
- It is very suitable for APD (Avalanche Photo Diode), because the capacitor has a withstanding voltage of 100V.

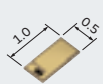

RUCYT101 Series

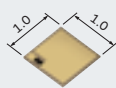

RUCYT201 Series

(in mm)

- Six types of standard samples of RUSUB® C+R (Capacitor + Resistor) are available.
- Custom substrate size, capacity, resistance value, and electrode pattern shape is available upon request.

Part Number	Size (mm) (LXWXT)	Capacitance (pF)	Resistance (Ω)	Temperature Characteristics of Capacitance at -25 to 85°C	Capacitor Rated Voltage (V)	Temperature Coefficient of Resistance (ppm/°C)	Resistor Rated Power (mW/mm ²)
RUCYT101K00009GNTC	1.0X0.5X0.11	100±10%	50±20%	±10%	100	-70±50	100
RUCYT101K00011GNTC	1.0X0.5X0.11	100±10%	100±20%				
RUCYT101K00012GNTC	1.0X0.5X0.11	100±10%	200±20%				
RUCYT201K00010GNTC	1.0X1.0X0.12	200±10%	50±20%				
RUCYT201K00013GNTC	1.0X1.0X0.12	200±10%	100±20%				
RUCYT201K00014GNTC	1.0X1.0X0.12	200±10%	200±20%				

■ Detailed Catalogs

For more details, please refer to our printed catalogs and the PDF catalogs on our website.



▪ Thin Film Circuit Substrate (RUSUB®)

Cat. No.M04E

Sensors

Summary

Murata pursued sensing functions making full use of MEMS and processing technology, and magnetoresistive elements including ceramic material technology in order to develop highly efficient and highly reliable devices, modules, and systems.

A lineup of various sensors respond to the sensing needs of various applications for automobile, wearable, medical care, and health care.

Lineup

- Infrared Sensors ● Ultrasonic Sensors ● Rotary Sensors
- Magnetic Pattern Recognition Sensors ● AMR Sensors (Magnetic Sensors)
- Shock Sensors ● Accelerometers
- Inclinometers ● Gyro Sensors ● Rotary Position Sensors
- Proximity and Ambient Light Sensors ● Barometric Pressure Sensors ● Temperature Sensors (Thermistors)



Sensor Guide (Select by Method/Principle)



Temperature

Thermistors: The resistance changes with the temperature.



NCP Series



NX Series



PRF Series

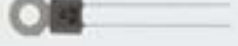

PTF Series



Infrared/Light

Pyroelectric infrared sensors: The sensor reacts to the infrared radiation emitted from the human body to output an electric charge.



IRA Series

Ambient light sensors: The built-in photo diode detects ambient light and infrared light.



LT Series

For more details on Thermistors, please refer to p. 64.



Detailed Catalogs

For more details, please refer to our printed catalogs and the PDF catalogs on our website.

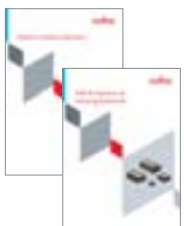

- MEMS Sensors & Sensing Elements
- Rotary Position Sensors
- NTC Thermistors
- POSISTOR® for Circuit Protection
- NTC/PTC Thermistors for Automotive

Cat. No. S47E
 Cat. No. R51E
 Cat. No. R44E
 Cat. No. R90E
 Cat. No. R03E



Distance

Ultrasonic sensors: The sensor sends and receives ultrasonic waves in order to detect distances from the state of the reflected wave.



Proximity/Open and Shut

Proximity sensors: The sensor sends and receives infrared light in order to detect the proximity from the state of the reflected light.



LT Series

Magnetic switches: This switch switches built-in ICs when the magnetoresistive element detects the magnetic proximity.



MR Series



Inertial force

Shock sensors: This sensor generates an electric charge according to the acceleration (stress) applied to the piezoelectric element.



PKGS Series

Accelerometers: This sensor detects the acceleration from the change of the capacitance that occurs in the 3DMEMS element.



SCA Series

Inclinometers: This sensor detects the gravitational acceleration of the Earth to calculate the angle of gradient.



SCA Series

Gyro sensors: This sensor detects the angular velocity from the change in the capacitance that occurs in the 3DMEMS element.



SCC Series
SCR Series



Magnetic

Rotary sensors: This sensor detects the motion of magnetic gears by a built-in magnet and magnetoresistive element.



FR Series

Magnetic switches: This switch switches built-in ICs when the magnetoresistive element detects magnetism.



MR Series

Magnetic pattern recognition sensors: This sensor identifies magnetic ink by the combination of a built-in magnet and magnetoresistive element.



BS Series



Pressure

Barometric pressure sensors: This sensor detects the atmospheric pressure applied to the 3DMEMS element by the capacitance.



ZPA Series



















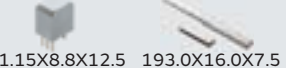

Angle

Rotary position sensors: The resistance changes in proportion to the angle.



SV03 Series

Lineup

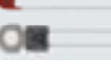
Murata's Sensors				Applications										
				AV Equipment					Communications Devices					
Detection	Products	Series or Main Part Number	Dimensions (mm)	TV	Audio	DVD, CD	Digital Video Camera	Digital Camera	PC	Scanner	Multifunction Machine	Printer	FAX	Electronic Bulletin Board
Infrared	Pyroelectric Infrared Sensors	IRA Series	 $\varnothing 9.2 \text{ H}4.7$	●	●	●			●	●	●	●	●	●
Ultrasonic	Open Structure Type Ultrasonic Sensors	MA40S4R (for Receiver) MA40S4S (for Transmitter)	 $\varnothing 9.9 \text{ H}7.1$											●
		MA40H1S	 $5.2 \times 5.2 \times 1.15$	●	●	●	●	●	●	●	●	●	●	●
	Drip-proof Type Ultrasonic Sensors	MA58MF14-7N (for Dual Use)	 $\varnothing 14.0 \text{ H}9.0$											
	High Frequency Type Ultrasonic Sensors	MA300D1-1 (for Dual Use)	 $\varnothing 9.9 \text{ H}7.3$							●	●	●		
Magnetic	Rotary Sensors	FR Series	 $\varnothing 22.5 \text{ H}12.5$											
	Magnetic Pattern Recognition Sensors	BS Series	 $11.15 \times 8.8 \times 12.5$ $193.0 \times 16.0 \times 7.5$											
	AMR Sensors (Magnetic Sensors)	MR Series	 MRMS201A: $2.8 \times 2.9 \times 1.1$ MRMS501A: $1.45 \times 1.45 \times 0.55$			●	●	●	●					
Acceleration	Shock Sensors	PKGS Series	 $3.2 \times 2.0 \times 1.05$						●					
	Accelerometers	SCA Series	 $10.48 \times 11.31 \times 5.08$											
	Inclinometers	SCA Series	 $15.58 \times 11.31 \times 5.08$								●			
Angle Velocity	Gyro Sensors	SCC Series SCR Series	 $8.5 \times 18.7 \times 4.5$											
Angle	Rotary Position Sensors	SV03 Series	 $11 \times 12 \times 2.1$	●				●			●	●		
Optical	Proximity and Ambient Light Sensors	LT Series	 $3.05 \times 2.1 \times 1.0$								●	●		
Atmosphere Pressure	Barometric Pressure Sensors	ZPA Series	 $2.6 \times 2.3 \times 0.875$											
Temperature	NTC Thermistors	Chip Type NCP Series	 NCP03: $0.6 \times 0.3 \times 0.3$ NCP15: $1.0 \times 0.5 \times 0.5$ NCP18: $1.6 \times 0.8 \times 0.8$ NCP21: $2.0 \times 1.25 \times 0.85$	●	●	●	●	●	●	●	●	●	●	●
		Lead Type NX Series	 NXF: $\varnothing 1.2$ L25 to 150 NXR: $\varnothing 4.0$ L10 to 40	●	●				●	●	●	●	●	●
	PTC Thermistors POSISTOR®	Chip Type PRF Series	 PRF15: $1.0 \times 0.5 \times 0.5$ PRF18: $1.6 \times 0.8 \times 0.8$ PRF21: $2.0 \times 1.25 \times 0.9$	●	●	●	●	●	●	●	●	●	●	●
		Lead Type PTF Series	 $\varnothing 5.0$ max. $T4.0$ max. $\varnothing 7.5$ $T3.0$	●	●				●	●	●	●	●	●

		Applications																		Wearable										
		Home Electronics										Security			Car Electronics		Toy		Others											
		Refrigerator	Electric Rice-cooker	Air Conditioner	Air Purification System	Humidifier	Cleaner	Laundry Machine	Food Fan	Water Heater	Toilet Seats with a Warm-water Shower Feature	Lighting	Security Camera	Security Light	Indoor Security Sensor	Intrusion Detection Sensor	Navigation System	Climate Control	Parking Assist	Radio Control (Attitude Control)	Game Controller	Machine Tool	ATM, CD	Vending Machine	Amusement Machine	Construction Machinery	Farm Machinery	Railroad Equipment	Murata's Sensors	Products
		●	●	●	●						●	●	●	●	●								●	●	●				Pyroelectric Infrared Sensors	
		●		●		●					●	●	●	●	●								●	●	●				Open Structure Type Ultrasonic Sensors	
		●	●	●	●	●	●	●	●	●	●	●	●	●	●					●	●		●	●	●				Drip-proof Type Ultrasonic Sensors	
																			●				●						High Frequency Type Ultrasonic Sensors	
																						●			●	●	●		Rotary Sensors	
																							●	●	●				Magnetic Pattern Recognition Sensors	
		●	●	●	●	●	●	●	●	●	●				●							●	●	●	●				AMR Sensors (Magnetic Sensors)	
																													Shock Sensors	
								●														●		●	●	●			Accelerometers	
																						●			●	●			Inclinometers	
								●									●					●		●	●	●			Gyro Sensors	
		●		●				●	●	●	●	●					●	●			●			●					Rotary Position Sensors	
																											●		Proximity and Ambient Light Sensors	
								●												●	●			●					Barometric Pressure Sensors	
		●	●	●	●	●	●	●	●	●	●					●					●		●	●					NTC Thermistors	
		●	●	●	●	●	●	●	●	●	●													●	●				PTC Thermistors	
		●	●	●	●	●	●	●	●	●	●					●					●			●					POSISTOR®	

Sensors

Thermistors

Facilitate your designs and products utilizing our thermal design and thermistor products.

Summary

Murata's semi-conductive ceramics and electrode printing technologies, such as PTC and NTC Thermistors, provide vital protection and sensing within electronic equipment. Simulation software tools are also available for your convenience.

Lineup

- NTC Thermistors for temperature sensor/compensation, inrush current suppression, and automotive
- PTC Thermistors POSISTOR® for overheat sensing, overcurrent protection, inrush current suppression, and automotive



NTC Thermistors for Temperature Sensor/ Temperature Compensation

Chip Type

Chip NTC Thermistors have Ni barrier terminations, provide excellent solderability, and offer high stability in harsh environments due to their unique inner construction.



NCP02 Series



NCP03 Series



NCP15 Series



NCP18 Series



NCP21 Series

(in mm)

Series	Size Code inch (mm)	Resistance (25°C) (Ω)	B-Constant (25-50°C) (K)	Permissible Operating Current (25°C) (mA)	Rated Electric Power (25°C) (mW)	Typical Dissipation Constant (25°C) (mW/°C)	Operating Temperature Range (°C)
NCP02	01005 (0402)	10k/100k	3380/4250	0.31/0.01	100	1	-40 to 125
NCP03	0201 (0603)	1.0k to 220k	3500 to 4485	0.06 to 9.5	100	1	-40 to 125
NCP15	0402 (1005)	220 to 470k	3500 to 4500	0.04 to 2.10	100	1	-40 to 125
NCP18	0603 (1608)	220 to 470k	3500 to 4500	0.04 to 2.10	100	1	-40 to 125
NCP21	0805 (2012)	220 to 100k	3500 to 4250	0.14 to 3.0	200	2	-40 to 125

Rated Electric Power shows the required electric power that causes the Thermistor's temperature to rise to 125°C by self heating, at ambient temperature of 25°C.

Detailed Catalogs

For more details, please refer to our printed catalogs and the PDF catalogs on our website.



- NTC Thermistors
- POSISTOR® for Circuit Protection
- NTC/PTC Thermistors for Automotive

Cat. No. R44E
Cat. No. R90E
Cat. No. R03E

Thermo String Type

Small flexible lead type NTC Thermistors with a small head and a thin lead wire.

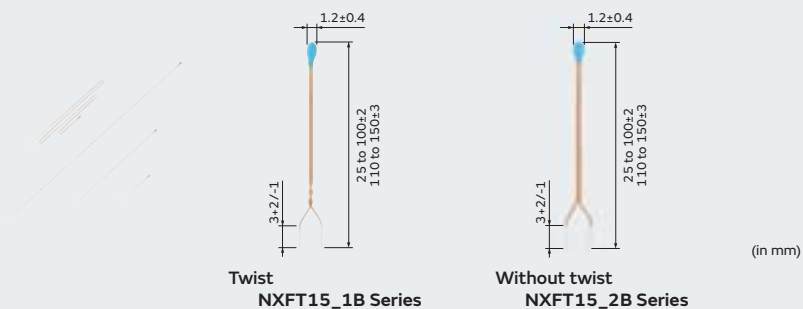

Series	Resistance (25°C) (Ω)	B-Constant (25-50°C) (K)	Operating Current for Sensor (25°C) (mA)	Thermal Time Constant (25°C) (s)	Full Length (mm)	Operating Temperature Range (°C)
NXFT15	10k to 100k	3380 to 4250	0.04 to 0.12	4	25 to 150	-40 to 125

Operating Current for Sensor raises the Thermistor's temperature by 0.1°C.
There are also items for automotive applications in the NXF Series.

Lead Type

This product is a thermistor for normal temperature level sensors having self-subsistence due to strong lead strength based on chip NTC.

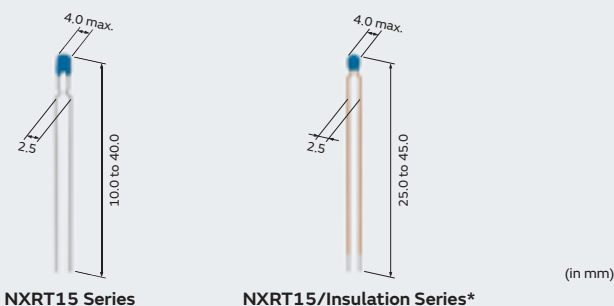

Series	Resistance (25°C) (Ω)	B-Constant (25-50°C) (K)	Operating Current for Sensor (25°C) (mA)	Thermal Time Constant (25°C) (s)	Full Length (mm)	Operating Temperature Range (°C)
NXRT15	2k to 100k	3380 to 4250	0.04 to 0.27	4	10 to 40	-40 to 125
NXRT15 (Insulation*)	2k to 100k	3380 to 4250	0.05 to 0.36	4	25 to 35	-40 to 125

Operating Current for Sensor raises the Thermistor's temperature by 0.1°C.
There are also items for automotive applications in the NXR Series.
*Insulation: Lead wire insulation type.

NTC Thermistors for Inrush Current Suppression

Effectively suppresses surge currents that are generated when switching power regulators are turned on.

NTPAN: 23.0 max.
NTPAJ: 20.0 max.
3.5 10.0 max.
10.0

NTPAD: 16.0 max.
NTPAA: 12.0 max.
3.5 10.0 max.
7.5

NTPA9: 11.0 max.
NTPA7: 9.0 max.
NTPAD: 7.5 max.
NTPA5: 6.0 max.
3.5 6.0 max.
5.0

(in mm)

NTPAN / J Series **NTPAD / A Series** **NTPA5 / D / 7 / 9 Series**

Series	Resistance (25°C) (Ω)	Permissible Max. Current (25°C) (A)	Permissible Max. Current (55°C) (A)	Thermal Time Constant (25°C) (s)	Permissible Electrolytic Capacitor (100V) (μF)	Operating Temperature Range (°C)
NTPAN / J	3 to 10	2.6 to 5.4	2.2 to 4.7	125 to 135	5000 to 8600	-20 to 160
NTPAD / A	2.2 to 16.0	1.7 to 3.7	1.5 to 3.2	65 to 100	1400 to 2700	-20 to 160
NTPA5 / D / 7 / 9	4.0 to 22.0	1.0 to 2.5	0.9 to 2.2	20 to 65	346 to 800	-20 to 160

PTC Thermistors POSISTOR® for Overheat Sensing

Chip Type

For overheat sensing for power transistors, power diodes, and power ICs in hybrid circuits.



Series	Sensing Temperature Range (°C)										Sensing Temperature Tolerance (°C)	Maximum Voltage (V)	Size Code inch (mm)
	60	70	80	90	100	110	120	130	140	150			
PRF15			●	●	●	●	●	●	●	●	±3/±5	32	0402 (1005)
PRF18	●	●	●	●	●	●	●	●	●	●	±3/±5	32	0603 (1608)
PRF21			●	●	●	●	●	●	●	●	±5	32	0805 (2012)

There are also items for automotive applications in the PRF Series.

Lead Type

For protecting power transistors, stereo main amplifiers, etc., from overheating, and also for sensing the temperature of other components that may be overheated.

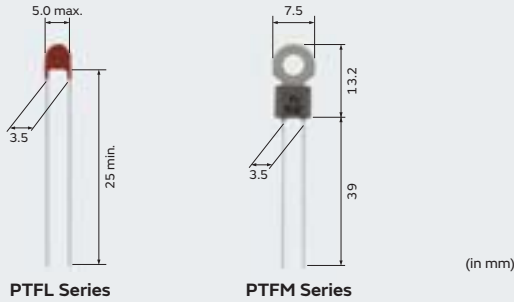

Series	Sensing Temperature Range (TS) (°C)										Maximum Voltage (V)	Resistance (25°C) (max.) (Ω)	Resistance (TS-10°C) (max.) (Ω)	Resistance (TS°C) (min.) (Ω)
	60	70	80	90	100	110	120	130	140	150				
PTF□_471Q	●	●	●	●	●	●					16	100	330	470
PTF□_222Q	●	●	●	●	●	●					16	330	1.5k	2.2k

The blank is filled with type codes. (L: Lead type, M: with lug-terminal)
Operating Temperature Range is -10 to TS+10°C.

PTC Thermistors POSISTOR® for Inrush Current Suppression

This series is able to support overcurrent or inrush current issues on the power supply circuit.

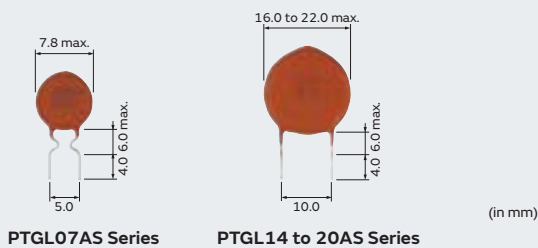

Series	Resistance (25°C) (Ω)	Maximum Voltage (V)	Maximum Inrush Current (Ao-p)	Maximum Charge Energy (J)	Operating Temperature Range (°C)
PTGL07AS	120 to 200	280	5.66 to 8.46	7.8 (105°C)	-40 to 105
PTGL14 to 20AS	33 to 100	280	13 to 39	56.9 to 181.7 (65 to 85°C)	-20 to 85

Maximum Inrush Current shows the maximum inrush current value introduced into the Posistor at operating temperature range.

PTC Thermistors POSISTOR® for Overcurrent Protection

Chip Type

Overcurrent Protection device with resettable function suitable for current-limiting resistors.

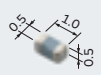

PRG15 Series

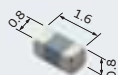

PRG18 Series



PRG21 Series

(in mm)

Series	Maximum Voltage (V)	Hold Current (60°C) (mA)	Trip Current (-10°C) (mA)	Maximum Current (A)	Resistance (25°C) (Ω)	Size Code inch (mm)
PRG15	6 to 30	17 to 88	78 to 318	0.6 to 3.5	2.2 to 68	0402 (1005)
PRG18	6 to 30	7 to 220	25 to 850	0.06 to 7.5	2.2 to 470	0603 (1608)
PRG21	6 to 30	30 to 500	110 to 2000	1.1 to 10	0.2 to 22	0805 (2012)

Maximum Current shows typical transformer capacities that can be used. There are also items for automotive applications in the PRG Series.

Lead Type

Best suited to meet the requirements of power supplies and motor protection. Error-free operation is ensured by rush current.

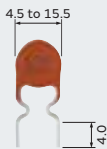

(in mm)

PTGL Series

*The Lead shape is an example.

Series	Maximum Voltage (V)	Hold Current (60°C) (mA)	Trip Current (-10°C) (mA)	Maximum Current (A)	Resistance (25°C) (Ω)
PTGL	16	370 to 1200	1040 to 3360	2.0 to 10.0	0.15 to 1.0
	24	80 to 180	320 to 710	2.0	2.2 to 10
	30	122 to 685	240 to 1900	0.7 to 7.0	0.8 to 13
	32	30 to 60	140 to 240	1.5	15 to 47
	51	168 to 592	332 to 1168	1.0 to 5.0	1.2 to 10
	56	90 to 380	240 to 980	1.0 to 2.5	3.3 to 22
	60	88 to 439	175 to 867	1.0 to 5.0	2.2 to 22
	80	50 to 310	135 to 860	0.7 to 5.5	3.7 to 55
	125	30 to 420	75 to 1050	0.3 to 2.0	3.3 to 180
	140	74 to 340	147 to 780	0.5 to 3.5	4.7 to 56
	250	90 to 100	280 to 300	0.5 to 0.6	12 to 39
	265	28 to 300	78 to 830	0.2 to 4.1	6.0 to 180

Maximum Current shows typical transformer capacities that can be used. There are also items for automotive applications in the PTGL Series.

Power Devices

Eco-friendly and high-quality power devices

Summary

To meet consumer needs Murata offers power supply products and energy devices that can be used with a variety of equipment, such as video equipment, household information appliances, and communication/transfer equipment. Murata provides standard and customized products using highly reliable, Murata-made components utilizing advanced design and high-density packaging technology.

Lineup

- DC-DC Converters ●Micro DC-DC Converters
- High Voltage Transformers ●High Voltage Power Supplies
- Switching Power Supplies



DC-DC Converters

DC-DC converters are vital to the demands of electronic equipment.

Murata offers DC-DC converters that set the standard for miniaturization, low-profile, high-efficiency, power-saving, low-noise power supplies. Murata provides standard products and customized products, ultra-low-profile products, and products for FPGAs.

Isolated Type



MYBQC01138AZTB



MYBQC01138AZTF



MYBEA01212AZT

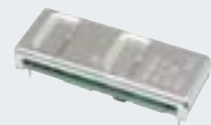

MYBEA01212AZTB

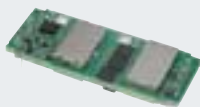

MYBEA01210CZT

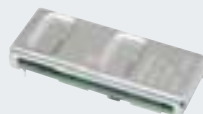

MYBEA01210CZTB

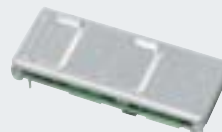

MYBEB01212AZTB



MYBTA00512ABT

Part Number	Package	Input Voltage (V)	Nominal Output Power (W)	Output Voltage (V)	Current (A)	Efficiency (%)	Isolation Voltage (VDC)	Footprint (Brick)	Size (mm) LXWXH
MYBQC01138AZTB	Insert	48V (36V to 75V)	400	10.6±6%	38	95	1500	1/4	58.4X36.8X14 max.
MYBQC01138AZTF	Insert	48V (36V to 75V)	400	10.6±6%	38	95	1500	1/4	58.4X36.8X17 max.
MYBEA01212AZT	Insert	48V (36V to 75V)	140	12±3%	12	92.5	1500	1/8	58.4X22.8X9 max.
MYBEA01212AZTB	Insert	48V (36V to 75V)	140	12±3%	12	92.5	1500	1/8	58.4X22.8X9 max.
MYBEA01210CZT	Insert	24V (18V to 36V)	120	12±3%	10	93	1500	1/8	58.4X22.8X9 max.
MYBEA01210CZTB	Insert	24V (18V to 36V)	120	12±3%	10	93	1500	1/8	58.4X22.8X9 max.
MYBEB01212AZTB	Insert	48V (36V to 75V)	100	12±3%	8.3	92	2250	1/8	58X22.8X12.7 max.
MYBTA00512ABT	SMD	48V (36V to 75V)	60	5±3%	12	92	2250	1/32	23.36X19.05X12.7 max.

These are just a few examples of our large assortment of power products.

Non-isolated Type



MPDRX307S
MPDRX308S



MPDRX312S



MPDTY461S
MPDTY462S



MYGTM01210BZN



MYLSM00502ERPL



MYMGK00506ERSR
MYMGK1R806FRSR



MYMGK1R820ERSR
MYMGK1R820FRSR



MYSSM01806BENL



MYUSP3R303FMP



OKL2-T/12-W12N2-C



OKL2-T/12-W5N-C



OKL2-T/20-W12N2-C
OKL2-T/20-W12P2-C



OKL2-T/20-W5N-C
OKL2-T/20-W5P-C



OKL-T/3-W5N-C



OKL-T/6-W12P-C

Part Number	Package	Input Voltage (V)	Nominal Output Power (W)	Output Voltage (V)	Current (A)	Efficiency (%)	Size (mm) LXWXH
MPDRX307S	SMD	6.2 to 13.2	23.6	1.8 to 3.63	6.5	91	17.6X20.2X4.2
MPDRX308S	SMD	6.2 to 13.2	10.7	0.8 to 1.65	6.5	82	17.6X20.2X4.2
MPDRX312S	SMD	3 to 5.5	28.8	0.8 to 1.8	16	86.5	27.8X15.4X4.2
MPDTY461S	SMD	4.5 to 14	94	1.6 to 3.63	26	90.5	33.02X13.46X4.2
MPDTY462S	SMD	4.5 to 14	43	0.75 to 1.65	26	85.5	33.02X13.46X4.2
MYGTM01210BZN	SIL	17 to 40	120	5 to 12	10	97.3	40X40.3X29.2
MYLSM00502ERPL	SMD	8 to 16	12.5	1 to 5.25	2.5	85	7.9X7.9X2.3
MYMGK00506ERSR	SMD	8 to 14	30	0.7 to 5.0	6	95.4	9.0X7.5X5.0
MYMGK1R806FRSR	SMD	4.5 to 5.5	10.8	0.7 to 1.8	6	90.4	9.0X7.5X5.0
MYMGK1R820ERSR	SMD	8 to 14	36	0.7 to 1.8	20	87.8	10.5X9.0X5.6
MYMGK1R820FRSR	SMD	4.5 to 5.5	36	0.7 to 1.8	20	89.2	10.5X9.0X5.6
MYSSM01806BENL	SMD	25 to 40	108	5 to 18	6	96.5	30.2X20.9X12
MYUSP3R303FMP	SMD	3 to 5.5	9.9	0.7 to 3.3	3	94	11X8.5X5.6
OKL2-T/12-W12N2-C	SMD	4.5 to 14	60	0.69 to 5.5	12	95	20.32X11.43X8.55
OKL2-T/12-W5N-C	SMD	2.4 to 5.5	39.6	0.6 to 3.63	12	94	20.32X11.43X8.55
OKL2-T/20-W12N2-C	SMD	4.5 to 14	100	0.69 to 5.5	20	94	33.02X13.46X8.75
OKL2-T/20-W12P2-C	SMD	4.5 to 14	100	0.69 to 5.5	20	94	33.02X13.46X8.75
OKL2-T/20-W5N-C	SMD	2.4 to 5.5	66	0.6 to 3.63	20	93.1	33.02X13.46X8.75
OKL2-T/20-W5P-C	SMD	2.4 to 5.5	66	0.6 to 3.63	20	93.1	33.02X13.46X8.75
OKL-T/3-W5N-C	SMD	2.7 to 5.5	10.9	0.6 to 3.63	3	95.3	12.2X12.2X6.2
OKL-T/6-W12P-C	SMD	4.5 to 14	33	0.591 to 5.5	6	93	12.2X12.2X7.2

These are just a few examples of our large assortment of power products.

Micro DC-DC Converters

Murata's micro DC-DC converters are small power modules that utilize a unique ferrite substrate with an embedded power inductor, and incorporate the I/O capacitors onto the same package.

Ultra-compact size and superior noise suppression make these devices ideal for cellular/smart phones, tablets, wearable devices, communication applications, and portable products.

General Buck Converter

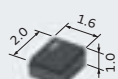

LXDC2MB Series



LXDC2HL Series

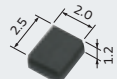

LXDC2HN Series



LXDC2UR Series



LXDC3EP Series



LXDC2XQ Series

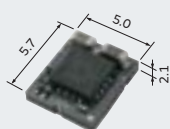

LXDC55F Series

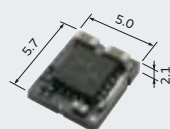

LXDC55K Series

(in mm)

Boost Converter

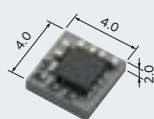

LXDC44A Series

(in mm)

Buck-Boost

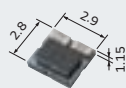

LXDC2SC Series

(in mm)

Series	Size (mm)		Input Voltage (V)	Output Voltage (V)	Output Current (mA)
	LXW	T (max.)			
LXDC2MB	2.0X1.6	1.0	2.0 to 5.5	1.0 to 3.3	<50
LXDC2HL**G	2.5X2.0	1.0	2.3 to 5.5	1.0 to 2.5	<300
LXDC2HL**A	2.5X2.0	1.1	2.3 to 5.5	1.0 to 3.3	<600
LXDC2HN**F	2.5X2.0	1.3	2.3 to 5.5	1.0 to 3.3	<600
LXDC2UR	2.5X2.3	1.2	2.7 to 5.5	1.2 to 3.3	<600
LXDC3EP	3.5X3.2	1.3	2.5 to 5.5	1.0 to 3.3	<1000
LXDC2XQ	2.8X2.6	1.14	2.7 to 5.5	1.0 to 3.3	<1500
LXDC55F	5.7X5.0	2.1	4.0 to 14.0	0.8 to 5.3 Set by Trim Resistor	<1500
LXDC55K	5.7X5.0	2.1	2.7 to 5.5	0.8 to 3.6 Set by Trim Resistor	<3000
LXDC44A	4.0X4.0	2.0	2.7 to 5.5	5.0, 6.0	<700
LXDC2SC	2.8X2.9	1.15	2.8 to 5.0	3.3	<1200

High Voltage Transformers

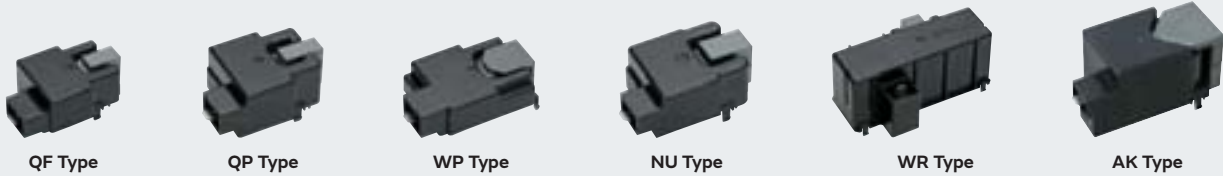

Series	Type	Features	Output Voltage Vout	Output Current Iout	Drive Frequency	Dimensions (mm) LXWXH
MSH	QF	Small Size	Max. 6kV	0.3mA	35 to 70kHz	39X24X13
	QP	Standard	Max. 8.5kV	0.4mA	35 to 70kHz	41X26X16
	WP	Low Profile	Max. 8.5kV	0.4mA	35 to 70kHz	44X27X11
	NU	High Power	Max. 8.5kV	1mA	30 to 70kHz	44X27X17
	WR	High Voltage	Max. 13kV	0.5mA	30 to 70kHz	49X65X27
	AK	High Voltage High Power	Max. 10kV	2mA	20 to 70kHz	55X28X26

High Voltage Power Supplies

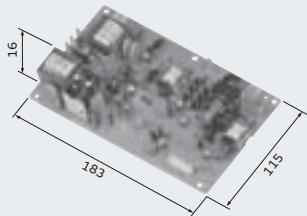

MPH7000 Series

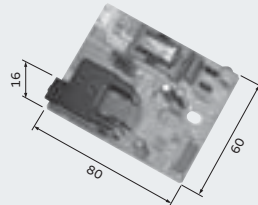

MPH4000 Series
(for Air Purifier/Air Conditioner)

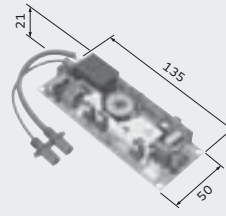

MPL3000 Series
(AC/DC Ballast)

(in. mm)

Series	Input Voltage Vin	Power Supply Type	Output Voltage Vout	Output Current Iout	Adjustable Range	
MPH7000	24V DC	DC Constant Current	(6kV)	250μA	Iout: 200 to 300μA	
		DC Constant Voltage	0.6kV	(1μA)	Vout: 550 to 650kV	
		Switching	DC Constant Current	(-1.5kV)	-3μA	Iout: -2 to -4μA
			DC Constant Voltage	1.5kV	(0.5μA)	Vout: 1.4 to 1.6kV
		AC Constant Voltage	1.5kV rms	(250μA rms)	Vout: 1.3 to 1.7kV rms	
MPH4000 (for Air Purifier/Air Conditioner)	24V DC	DC Constant Voltage	±6kV	±400μA	-	
		DC Constant Current	(±6kV)	±400μA	-	

Series	Applications	Input Voltage Vin	Output Power	Other Specification
MPL3000 (AC/DC Ballast)	Projector	250 to 420V DC	to 350W	For extra-high pressure mercury lamp

For more details on our products, please contact us.

Switching Power Supplies

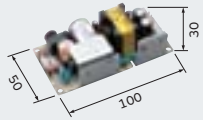

Medical Equipment

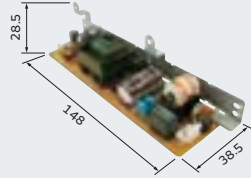

SOHO Equipment

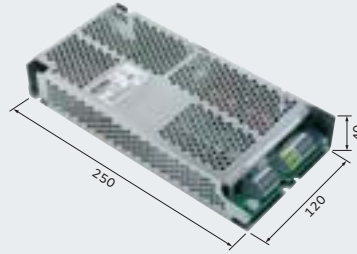

Industrial and Measurement Equipment

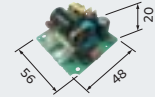

Energy Management Equipment

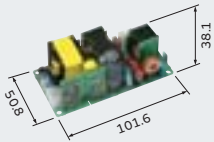

PBX

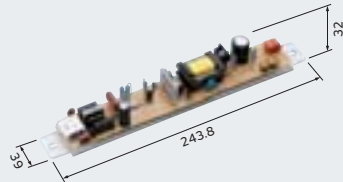

LED Lighting

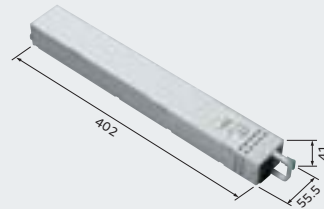

HVDC

(in mm)

Applications	Input Voltage	Output Voltage	Safety Standard	EMI Standard	Remarks
Medical Equipment	90 to 264V AC	5V 12V 24V 48V	UL, IEC	CISPR	
SOHO Equipment	90 to 264V AC	5V 12V 24V 48V	UL, IEC	CISPR	Models that provide a power-saving standby mode are also available.
Industrial and Measurement Equipment	90 to 264V AC	24V	UL, IEC	VCCI	150W/300W
Energy Management Equipment	60 to 225V AC	3.3V 24V	UL, IEC	VCCI, CISPR	
PBX	90 to 264V AC	12V 48V	UL, IEC	CISPR	Operating Ambient Temperature 80°C
LED Lighting	90 to 264V AC	24V	IEC, PSE	VCCI, CISPR	PWM Dimming, Accepted for DALI, UART
HVDC	200 to 400V DC	12.12V	-	VCCI	PMBus

For more details on our products, please contact us.

For Ionizer Modules, please refer to p. 81.

Energy Devices

Solutions for power lines of low-power devices

Summary

Murata offers various energy devices that can be used for low-power devices such as portable or wearable devices. Murata's supercapacitors (EDLC), having ultra-low ESR and high reliability, can be used as a small auxiliary power supply for peak power assist or backup. Murata's small energy device is a secondary battery having high-rate charge-discharge characteristics and long cycle life. It can be used as a power supply of low-power devices.

Lineup

- Supercapacitors (EDLC)
- Small Energy Devices (Lithium Ion Batteries)



Supercapacitors (EDLC)

Supercapacitors (EDLC) are energy storage devices with high power density characteristics. Murata has focused its R&D efforts on electrical double-layer energy devices, and also established collaboration with the component design and manufacturing firm CAP-XX Limited (CAP-XX). This has led to Murata's development of Supercapacitor technology resulting in low ESR and high capacitance in a very small package.



DMT3N4R2U224M3DTA0
DMT334R2S474M3DTA0
DMF3Z5R5H474M3DTA0



DMF4B5R5G105M3DTA0

(in mm)

Series	Main Part Number	Thickness (mm)	Capacitance (mF)	Rated Voltage (V)	ESR (mΩ)	Operating Temperature (°C)
DMT (General-Purpose Type)	DMT3N4R2U224M3DTA0	2.0	220	4.2	300	-40 to 85
	DMT334R2S474M3DTA0	3.5	470	4.2	130	-40 to 85
DMF (High Peak Power Type)	DMF3Z5R5H474M3DTA0	3.2	470	5.5 (Peak Voltage)	45	-40 to 70
	DMF4B5R5G105M3DTA0	3.7	1000	5.5 (Peak Voltage)	40	-40 to 70

Detailed Catalogs

For more details, please refer to our PDF catalogs on our website.



- High Performance Supercapacitor (EDLC) DMF Series
Cat. No. O83E
- High Performance Supercapacitor (EDLC) DMT Series
Cat. No. O84E

Small Energy Devices (Lithium Ion Batteries)

Murata's small energy devices are miniature devices with a high energy storage capacity, low ESR, fast charging and discharging, and the ability to withstand load fluctuations. It may be used as a secondary battery in the same way as a capacitor. This energy device achieves better charge/discharge characteristics and has an extended service life superior to conventional batteries. Well suited as a power supply for wearable devices or sensor nodes for wireless sensor networks, this device maintains flat voltage characteristics while accommodating a wide range of load characteristics.

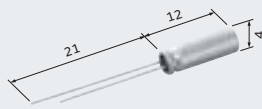

(in mm)

UMAC040130A003TA01

Series	Part Number	Nominal Voltage (V)	Charge Voltage (V)	Cut-off Voltage (V)	Nominal Capacity (mAh)	Max. Discharge Current	ESR (mΩ)	Operating Temperature Range (°C)
UMAC (Cylinder Type)	UMAC040130A003TA01	2.3	2.7	1.8	3	30mA (10C)	800	-20 to 70

Please contact Murata sales representative if you need higher capacity or thinner package size.

Sound Components (Buzzer)

Piezoelectric ceramic materials that expand and shrink by applying voltage are used in piezoelectric sound components.

Summary

Using Murata's unique ceramic material, we offer a variety of piezoelectric sound components.

Lineup

- SMD Piezoelectric Sounders
- Pin Type Piezoelectric Sounders
- Piezoelectric Buzzers
- Piezoelectric Diaphragms



SMD Piezoelectric Sounders

Low power consumption, lightweight.

Optimized for small devices such as blood glucose meters, clinical thermometers, photoflashes for cameras, and portable terminals.

Applications	Mounting Type	Drive Type	Main Part Number	Sound Pressure Level (typ.)	Measurement Condition of Sound Pressure Level
For Automotive	Surface Mounting Type	External Drive	PKLCS1212E20A0-R1	76dB	±1.5Vo-p, 2.0kHz, square wave, 10cm
			PKLCS1212E24A0-R1	80dB	±1.5Vo-p, 2.4kHz, square wave, 10cm
			PKLCS1212E40A1-R1	84dB	±1.5Vo-p, 4.0kHz, square wave, 10cm
For Consumer			PKLCS1212E2000-R1	76dB	±1.5Vo-p, 2.0kHz, square wave, 10cm
			PKLCS1212E2400-R1	80dB	±1.5Vo-p, 2.4kHz, square wave, 10cm
			PKLCS1212E4001-R1	84dB	±1.5Vo-p, 4.0kHz, square wave, 10cm
			PKMCS0909E4000-R1	74dB	±1.5Vo-p, 4.0kHz, square wave, 10cm

Detailed Catalogs

For more details, please refer to our printed catalogs and the PDF catalogs on our website.



• Piezoelectric Sound Components

Cat. No. P37E

Pin Type Piezoelectric Sounders

Low power consumption, lightweight.

These products are optimized for operation confirmation sounds and warning sounds in household appliances such as air conditioners, washers, and refrigerators.

Packaging	Mounting Type	Drive Type	Main Part Number	Sound Pressure Level (typ.)	Measurement Condition of Sound Pressure Level
Taping	Pin Type	External Drive	PKM13EPYH4000-A0	78dB	±1.5Vo-p, 4.0kHz, square wave, 10cm
Bulk			PKM13EPYH4002-B0	78dB	±1.5Vo-p, 4.0kHz, square wave, 10cm
			PKM17EPP-2002-B0	79dB	3.0Vo-p, 2.0kHz, square wave, 10cm
			PKM22EPH2001	85dB	±1.5Vo-p, 2.0kHz, square wave, 10cm
			PKM22EPPH2001-B0	79dB	±1.5Vo-p, 2.0kHz, square wave, 10cm
			PKM22EPPH4007-B0	92dB	±1.5Vo-p, 4.0kHz, square wave, 10cm

Piezoelectric Buzzers

This is a unified piezoelectric sounder connected to a built-in self-drive circuit, and it easily generates sound with only a DC power supply.

Suitable for gas detector alarms/burglar alarms/home-electronic appliances.

Mounting Type	Drive Type	Main Part Number	Sound Pressure Level (min.)	Measurement Condition of Sound Pressure Level
Pin Type	Self Drive	PKB24SPCH3601-B0	90dB	12Vdc, 10cm

Piezoelectric Diaphragms

Low power consumption, lightweight.

Suitable for clocks/calculators/digital cameras/burglar alarms, and various alarms.

Drive Type	Main Part Number	Plate Size (øD)
External Drive	7BB-12-9	ø12.0mm
	7BB-15-6	ø15.0mm
	7BB-20-6	ø20.0mm
	7BB-27-4	ø27.0mm

□: Indicates Metal Plate Diameter and Resonant Frequency Type.

Wireless Communication Modules

Available for a wide range of applications such as automotive, mobile computing devices, and household appliances.

Wi-Fi® Modules / Bluetooth® · Wi-Fi® Combo Modules



■ Features

Compact, highly efficient, and flexible custom-made correspondence

■ Applications

Mobile phones, automotive, tablet PC, POS, HT, electric equipment, smart grid, etc.

Bluetooth® Modules / Bluetooth® Low Energy Modules



■ Features

Compact, highly efficient, and flexible custom-made correspondence

■ Applications

Mobile phones, automotive, PMP, POS, HT, healthcare, wireless remote control, etc.

Variable Capacitors

Capacitance value can be adjusted by the tuning voltage.

LXRW_V Series



LXRW0YV Series



LXRW19V Series

(in mm)

Thin film variable capacitors can carry out the variable of the capacitor by adjusting the tuning voltage. It is designed for use as frequency matching for HF band (13.56MHz).

Micromechatronics

Utilizing the vibration and deformation properties of piezoelectric materials.

Microblowers

Tiny air pumps without a motor



■ Features

Microblowers are designed to function as an air pump, using the ultrasonic vibrations of piezoelectric ceramics, which can generate high pressure air from a thin and extremely compact unit.

■ Applications

Aroma/diffuser, gas & alcohol sensor, air ionizer, amusement, etc.

Part Number	Size	Air Flow	Static Pressure	Voltage of Operation
MZB1001T02	20(W)X20(L)X1.85(H)mm without the nozzle	≥0.7L/min@15Vp-p	≥1.42kPa@15Vp-p	10 to 20Vp-p

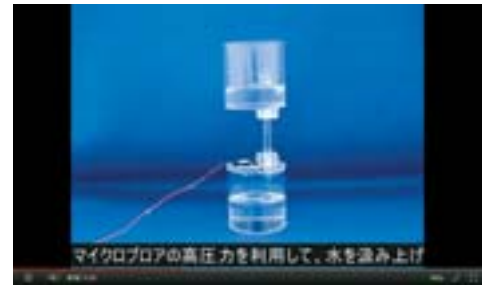
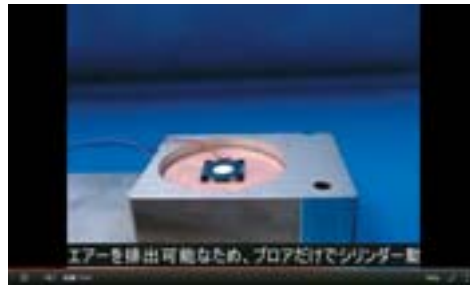

For more details on Microblowers, please refer to our website.

Piezoelectric Actuators

Quick response and high-accuracy position control.



■ Features

Piezoelectric actuators employ piezoelectric ceramics, which are widely used for positioning devices.

Ceramic Applied Products

Contribution to high integration and miniaturization requirements of the automotive industry and RF modules.

Low Temperature Co-fired Ceramics (LTCC) Multi-layer Module Boards



LTCC, Low Temperature Co-fired Ceramics, is a multi-layer, glass ceramic substrate that is co-fired with low resistance metal conductors. What makes Murata's LTCC special is our unique "Zero Shrinking Sintering Process," which restricts the ceramic shrinkage to only thickness.

Murata's LTCC multilayer substrates LFC® are useful in a wide range of electronic equipment such as substrates for highly reliable electronic control units equipping vehicles and functional substrates for miniaturized high-frequency modules in cellular phones.

LFC® Series

Murata's LFC® Series LTCC substrate meets high integration and miniaturization requirements necessary for automotive applications.

AWG Series

Utilized in low-profile, small outline RF modules, the AWG Series features ultra-thin ceramic tapes, multiple material tape lamination, and enhanced board strength.



Cat.No. N20E

Ionizer Modules Ionissimo®

High-concentration ion, compact design, ozone control

Ionissimo® is an ionizer module with unprecedented compactness and high efficiency, capable of generating the largest number of ions in the industry* owing to Murata's own high-voltage technology and structural design. The ion generator is connected to the driving power supply for modularization and ease of incorporating into equipment.

*Surveyed by Murata (as of March 2011)

MHM Series

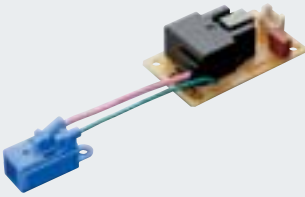

■ Features

- A large number of ions will be created by the original structure.
- Compact equipment may be designed due to small ionizer element and driving power supply.
- Ozone amounts may be optimized for specific applications by controlling the generation of ozone without changing the number of ions.

■ Applications

Air conditioner, air purifier, static eliminator, vacuum cleaner, etc.

Items	MHM314 Type	MHM305 Type	MHM306 Type	MHM400 Type
Input Voltage (VDC)	+10.8 to 13.2	←	←	←
Power	0.9W	0.4W	0.6W	0.6W
Ion Polarity	Negative	←	←	Positive
Ion Amount (*1)	>20000000pcs/cc (*2)	>20000000pcs/cc	←	←
Ozone Level	0.1mg/H (typ.)	<0.1mg/H	<1.0mg/H	<0.1mg/H
Operating Temp.	-10 to 50°C	←	←	←
Operating Humidity	20 to 80%RH (without dewdrop)	←	←	←

(*1) Measuring distance : 20cm

(*2) MHM314's Ion amount is around 3 times compare with MHM305.

View a demonstration video of Ionizer Modules Ionissimo® on our website.

Ozonizer Modules Ionissimo®

By using low temperature co-fired ceramic substrate (LTCC) for the discharger ozone will be generated stably.

MHM Series



■ Features

- Stable ozone generation.
- MHM501 type can be used under high humidity conditions.
- Small size

■ Applications

Refrigerator, vacuum cleaner, dishwasher, clothes washer, etc.

Items	MHM500 Type	MHM501 Type	MHM502 Type
Input Voltage (VDC)	+11 to 13	←	←
Power	1.0W	1.0W (with heater)	6.0W
Ozone Level	<2.5mg/H	<2.5mg/H	<60mg/H
Operating Temp.	-10 to 50°C	←	←
Operating Humidity	20 to 80%RH (without dewdrop)	20 to 95%RH	20 to 85%RH (without dewdrop)

View a demonstration video of Ozonizer Modules Ionissimo® on our website.

RFID Devices

RFID for transferring identification data by wireless communication. The state-of-the-art technology allows IC tags to be attached to places where traditional barcode and QR code technology could suffer from aging. Murata offers a comprehensive range of items required to introduce IC tags, from RFID devices to high-quality antennas, reader/writers, and software applications. With the complete kits from Murata, RFID is seamlessly and reliably implemented.

HF (13.56 MHz) RFID Devices (MAGICSTRAP®)

	LXMS33HCNG-134	LXMSAPHA08-136	LXMS33HCNK-171	LXMSAPHA17-176	LXTB5HHCNK-002
Appearance					
Frequency	HF (13.56MHz)				
Standard	ISO15693		ISO14443 typeA, NFC forum type2		
IC	NXP ICODE® SLIX		NXP NTAG210	NXP NTAG213	NXP NTAG210
UID memory	64 bits				
User memory	896 bits		384 bits	1152 bits	384 bits
Size (mm)	3.2 x 3.2	8.3 x 8.3	3.2 x 3.2	8.3 x 8.3	5.5 x 5.5
Thickness	0.7mm max.	0.8mm max.	0.75mm max.	0.8mm max.	2.5mm max.
In-mold process	○	N/A	○	N/A	○
Read range*	20mm	42mm	15mm	32mm	25mm

■ Antenna, Reader/Writer unit



■ SPI-USB converter unit



* Read range depends on the performance of the reader, the power, the antenna size, etc.

UHF (860/920 MHz) RFID Devices (MAGICSTRAP®)

	LXMS21NCNH-147	LXMS21ACMF-183	LXMS21ACNP-184	LXMSANAA19-181	LXMSANAA18-182
Appearance					
Frequency	UHF (865 to 928MHz)			UHF (902 to 928MHz)	UHF (865 to 868MHz)
Standard	EPC global Gen2 V1.2.0 ISO/IEC18000-63	EPC global Gen2 v2 ISO/IEC18000-63	EPC global Gen2 V1.2.0 ISO/IEC18000-63	EPC global Gen2 v2 ISO/IEC18000-63	
IC	NXP G2iM	Impinj monza® R6	NXP UCODE® 7xm	Impinj monza® R6	
User memory	512 bits	N/A	1024 bits	N/A	
EPC memory	256 bits	96 bits	448 bits	96 bits	
Size (mm)	2.0 x 1.25	2.0 x 1.2	2.0 x 1.2	40 x 6	
Thickness	0.55mm max.	0.5mm max.	0.5mm max.	0.9mm max.	
Antenna	Integrated	External	External	Integrated	
In-mold process	○	○	○	N/A	
Read range* (4wEIRP)	5mm	9m	7m	4m	

■ Antenna, Reader/Writer unit

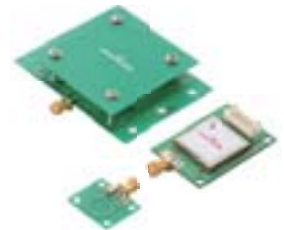

■ UART-USB converter unit



* Read range depends on the performance of the reader, the power, the antenna size, etc.

Note: MAGICSTRAP® is a registered trademark of Murata Manufacturing Co., Ltd.

Note: Windows is a registered trademark of USA-based Microsoft Corporation in the United States and/or in other countries.

Note: monza is a registered trademark of USA-based Impinj, Inc. in the United States and/or in other countries.

Note: ICODE and UCODE are a registered trademarks of USA-based NXP Semiconductors NV. in the United States and/or in other countries.

Memo

Application Guides



Smart Phones

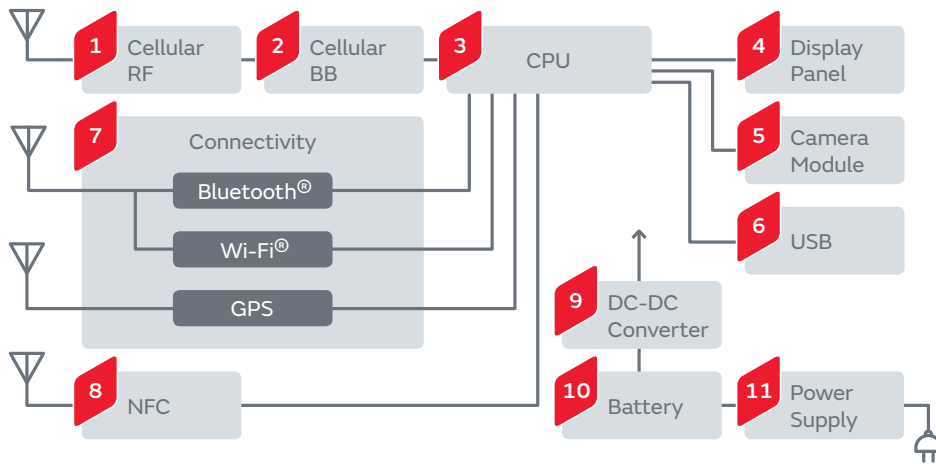

1 Cellular RF

<p>Chip Multilayer Diplexers LFD Series</p>	<p>SAW Duplexers SAY Series</p>	<p>SAW Filters SAF Series</p>	<p>Chip Multilayer LC Filters LF Series</p>
<p>Chip Multilayer Hybrid Baluns LDB/LDM Series</p>	<p>Chip Multilayer Hybrid Couplers LDC/LDJ Series</p>	<p>High-Frequency Matching Transformers SMST Series</p>	
<p>Microwave Coaxial Cable Connectors</p>	<p>Microwave Coaxial Connectors with Switch</p>	<p>Micro DC-DC Converters LXDC Series</p>	<p>Chip Inductors (Chip Coils) LQW/LQP Series</p>
<p>Trimmer Capacitors TZY2 Series</p>	<p>ESD Protection Devices LXES Series</p>		<p>Thermistors NCP/PRF Series</p>

2 Cellular BB

<p>Micro DC-DC Converters LXDC Series</p>
<p>3 Terminal Capacitors NFM Series</p>
<p>Chip Common Mode Choke Coils DLW/DLP Series</p>
<p>Thermistors NCP/PRF Series</p>

3 CPU

<p>Crystal Units XRC Series</p>	<p>Chip Ferrite Beads BLM Series</p>	<p>3 Terminal Capacitors NFM Series</p>	<p>Thermistors NCP/PRF Series</p>
-------------------------------------	--	---	---------------------------------------

5 Camera Module

<p>Micro DC-DC Converters LXDC Series</p>	<p>Supercapacitors (EDLC) DMF/DMT Series</p>
<p>Monolithic Ceramic Capacitors for Medium Voltage GR7 Series</p>	<p>Actuators</p>
<p>Chip Ferrite Beads BLM Series</p>	<p>ESD Protection Devices LXES Series</p>
<p>Low Temperature Co-fired Ceramics (LTCC) Ceramic Multilayer Substrates LFC®</p>	<p>Thermistors NCP/PRF Series</p>















4 Display Panel

<p>Micro DC-DC Converters LXDC Series</p>	<p>Ceramic Resonators CERALOCK® CSTCE Series</p>	<p>EMI Suppression Filters EMIFIL® NFA Series</p>
<p>ESD Protection Devices LXES Series</p>	<p>Chip Common Mode Choke Coils DLW/DLP Series</p>	<p>Thermistors NCP/PRF Series</p>







6 USB

<p>Micro DC-DC Converters LXDC Series</p>	<p>Chip Common Mode Choke Coils DLW/DLP Series</p>	<p>Chip Ferrite Beads BLM Series</p>	<p>ESD Protection Devices LXES Series</p>	<p>Thermistors NCP/PRF Series</p>
---	--	--	---	---------------------------------------



7 Connectivity

<p>Chip Multilayer Diplexers LFD Series</p> 	<p>Chip Multilayer Hybrid Couplers LDC/LDJ Series</p> 	<p>Bluetooth® Modules</p> 	<p>Wi-Fi® Modules</p> 	<p>Bluetooth® - Wi-Fi® Combo Modules</p> 
<p>SAW Filters SAF Series</p> 	<p>Chip Multilayer LC Filters LF Series</p> 	<p>Chip Multilayer Hybrid Baluns LDB/LDM Series</p> 	<p>Microwave Coaxial Cable Connectors</p> 	<p>Microwave Coaxial Connectors with Switch</p> 
<p>Micro DC-DC Converters LXDC Series</p> 	<p>ESD Protection Devices LXES Series</p> 	<p>Thermistors NCP/PRF Series</p> 	<p>Crystal Units XRC Series</p> 	

8 NFC

<p>NFC Antennas FLAN Series</p> 	<p>Crystal Units XRC Series</p> 
<p>Chip Ferrite Beads BLM Series</p> 	<p>Chip Inductors (Chip Coils) LQM/LQH Series</p> 
<p>Trimmer Capacitors TZY2 Series</p> 	<p>Variable Capacitors LXRW Series</p> 
<p>ESD Protection Devices LXES Series</p> 	

9 DC-DC Converter





<p>Metal Terminal Type Monolithic Ceramic Capacitors KRM Series</p> 	<p>Monolithic Ceramic Capacitor on Interposer Board ZRB Series</p> 	<p>Micro DC-DC Converters LXDC Series</p> 
<p>Polymer Aluminum Electrolytic Capacitors ECAS Series</p> 	<p>Thermistors NCP/PRF Series</p> 	















10 Battery

Thermistors
NCP/PRF/PRG Series



11 Power Supply

<p>Monolithic Ceramic Capacitors for Medium Voltage GR/GA Series</p> 	<p>High Temperature Guaranteed Low Loss Lead Type Ceramic Capacitor DEA Series</p> 	<p>Safety Standard Certified Ceramic Capacitors Type KX/KY</p> 	<p>Chip Inductors (Chip Coils) LQM/LQH Series</p> 
--	--	---	---

General Purpose	Monolithic Ceramic Capacitors	GRM Series	Coupling/Decoupling/For Step-up	
	Monolithic Ceramic Capacitors	GJM Series	High Frequency Filter Circuit	
	Resin External Electrode Monolithic Ceramic Capacitors	GRJ Series	Coupling/Decoupling/For Step-up	
	Polymer Aluminum Electrolytic Capacitors	ECAS Series	Smoothing/Transient Backup	
	Chip Inductors (Chip Coils)	LQW/LQP/LQG Series	High Frequency Circuit-Impedance Matching/Resonance	
	Chip Inductors (Chip Coils)	LQM/LQH/DFEC Series	Voltage Conversion	
	Chip Ferrite Beads	BLM Series	Noise Suppression	
	3 Terminal Capacitors	NFM Series	Noise Suppression	
	Feed Through Chip EMI Filters	NFE Series	Noise Suppression	
	Chip Common Mode Choke Coils	DLW/DLP Series	Noise Suppression	
	Microwave Absorbers	EA Series	Noise Suppression	
	Ferrite Cores	FS Series	Noise Suppression	
	Thin Type Sandwich Cores	FSSA Series	Noise Suppression	
Small Energy Devices	UMAC Series	Battery Backup		

Wearable Devices

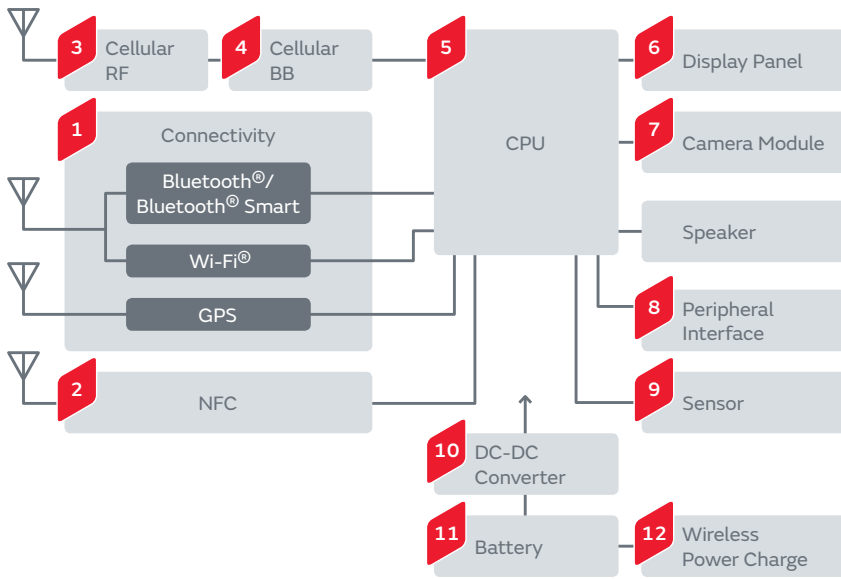

1 Connectivity

Bluetooth® Modules	Wi-Fi® Modules	Bluetooth® - Wi-Fi® Combo Modules	SAW Filters SAF Series	Chip Multilayer LC Filters LF Series
Chip Multilayer Hybrid Baluns LDB/LDM Series	Chip Multilayer Diplexers LFD Series	Chip Multilayer Hybrid Couplers LDC/LDJ Series	Micro DC-DC Converters LXDC Series	Crystal Units XRC Series
Microwave Coaxial Cable Connectors	Microwave Coaxial Connectors with Switch	ESD Protection Devices LXES Series	Thermistors NCP/PRF Series	

2 NFC

NFC Antennas FLAN Series	Micro DC-DC Converters LXDC Series	Crystal Units XRC Series
Chip Inductors (Chip Coils) LQM/LQH/LQB Series	Trimmer Capacitors TZY2 Series	
Variable Capacitors LXRW Series	ESD Protection Devices LXES Series	

3 Cellular RF

Chip Multilayer Diplexers LFD Series	SAW Duplexers SAY Series	SAW Filters SAF Series
Chip Multilayer LC Filters LF Series	Chip Multilayer Hybrid Baluns LDB/LDM Series	Chip Multilayer Hybrid Couplers LDC/LDJ Series
High-Frequency Matching Transformers SMST Series	Microwave Coaxial Cable Connectors	Microwave Coaxial Connectors with Switch
Micro DC-DC Converters LXDC Series	Trimmer Capacitors TZY2 Series	
ESD Protection Devices LXES Series	Thermistors NCP/PRF Series	

4 Cellular BB

Micro DC-DC Converters LXDC Series	Thermistors NCP/PRF Series
------------------------------------	----------------------------

5 CPU

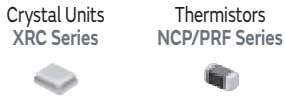

6 Display Panel



7 Camera Module

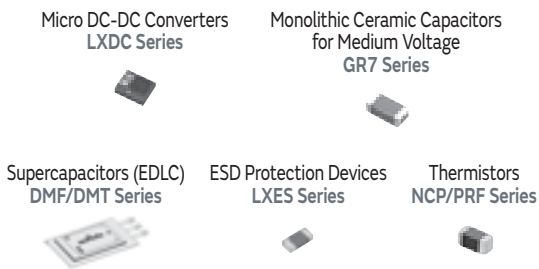

8 Peripheral Interface

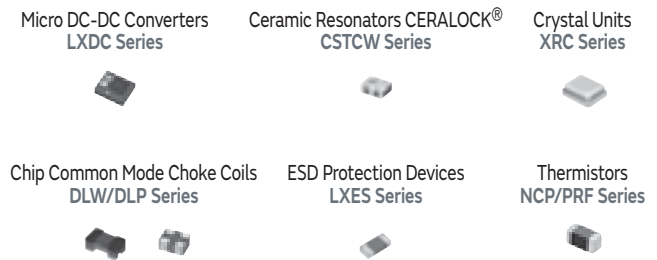

9 Sensor



10 DC-DC Converter

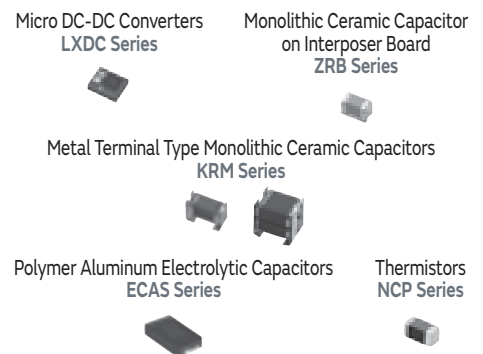

11 Battery

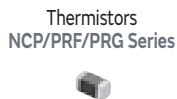

12 Wireless Power Charge

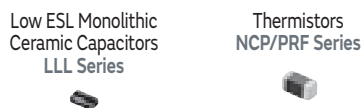

General Purpose	Monolithic Ceramic Capacitors	GRM Series	Coupling/Decoupling/For Step-up	
	Monolithic Ceramic Capacitors	GJM Series	High Frequency Filter Circuit	
	Resin External Electrode Monolithic Ceramic Capacitors	GRJ Series	Coupling/Decoupling/For Step-up	
	Polymer Aluminum Electrolytic Capacitors	ECAS Series	Smoothing/Transient Backup	
	Supercapacitors (EDLC)	DMF/DMT Series	Power Line/Battery Peak Assist	
	Chip Inductors (Chip Coils)	LQW/LQP/LQG Series	High Frequency Circuit-Impedance Matching/Resonance	
	Chip Inductors (Chip Coils)	LQM/LQH/DFEC Series	Voltage Conversion	
	Chip Ferrite Beads	BLM Series	Noise Suppression	
	3 Terminal Capacitors	NFM Series	Noise Suppression	
	Feed Through Chip EMI Filters	NFE Series	Noise Suppression	
	Chip Common Mode Choke Coils	DLW/DLP Series	Noise Suppression	
	Microwave Absorbers	EA Series	Noise Suppression	
	Ferrite Cores	FS Series	Noise Suppression	
	Thin Type Sandwich Cores	FSSA Series	Noise Suppression	
	Small Energy Devices	UMAC Series	Battery Backup	
	Piezoelectric Sounders	PKMCS Series	Sound component	
Piezoelectric Diaphragms	7BB Series	Sound component		

Base Stations

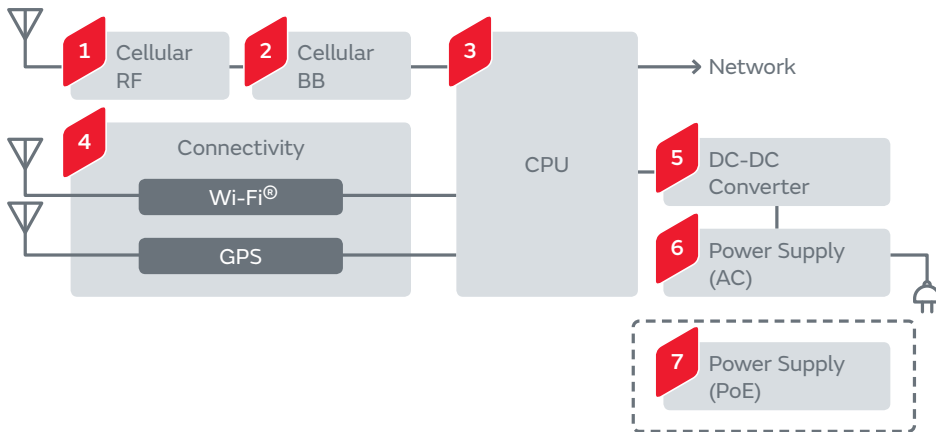

1 Cellular RF

<p>Chip Multilayer Diplexers LFD Series</p>	<p>Duplexers DFYH Series</p>	<p>Dielectric Filters GIGAFIL® DFCH Series</p>	<p>Chip Multilayer LC Filters LF Series</p>
<p>Chip Multilayer Hybrid Baluns LDB/LDM Series</p>	<p>Chip Multilayer Hybrid Couplers LDC/LDJ Series</p>	<p>Isolators CES Series</p>	<p>Chip Inductors (Chip Coils) LQW/LQP Series</p>
<p>Trimmer Capacitors TZY2 Series</p>	<p>ESD Protection Devices LXES Series</p>	<p>Thermistors PRF Series</p>	

2 Cellular BB

<p>3 Terminal Capacitors NFM Series</p>
<p>Chip Common Mode Choke Coils DLW/DLP Series</p>
<p>Thermistors PRF Series</p>

3 CPU

<p>Crystal Units/ Crystal Oscillators</p>
<p>Chip Ferrite Beads BLM Series</p>
<p>3 Terminal Capacitors NFM Series</p>
<p>Thermistors PRF Series</p>

4 Connectivity

<p>Wi-Fi® Modules</p>	<p>Chip Multilayer LC Filters LF Series</p>	<p>Chip Multilayer Hybrid Baluns LDB/LDM Series</p>	<p>Chip Multilayer Diplexers LFD Series</p>
<p>Chip Multilayer Hybrid Couplers LDC/LDJ Series</p>	<p>Micro DC-DC Converters LXDC Series</p>	<p>ESD Protection Devices LXES Series</p>	<p>Thermistors PRF Series</p>
			<p>Crystal Units XRC Series</p>

5 DC-DC Converter

<p>DC-DC Converters MYB Series</p>	<p>DC-DC Converters OKL Series</p>	<p>Micro DC-DC Converters LXDC Series</p>	<p>Metal Terminal Type Monolithic Ceramic Capacitors KRM Series</p>
	<p>Polymer Aluminum Electrolytic Capacitors ECAS Series</p>	<p>Thermistors PRF Series</p>	

6 Power Supply (AC)

Monolithic Ceramic Capacitors for Medium Voltage GR/GA Series 

High Temperature Guaranteed Low Loss Lead Type Ceramic Capacitor DEA Series 

Safety Standard Certified Ceramic Capacitors Type KX/KY 

Chip Inductors (Chip Coils) LQM/LQH Series 

7 Power Supply (PoE)















Monolithic Ceramic Capacitors for Medium Voltage GR/GA Series 

High Temperature Guaranteed Low Loss Lead Type Ceramic Capacitor DEA Series 

Crystal Units XRC Series 

Metal Terminal Type Monolithic Ceramic Capacitors KRM Series 

Chip Inductors (Chip Coils) LQM/LQH Series 

General Purpose	Monolithic Ceramic Capacitors	GRM Series	Coupling/Decoupling/For Step-up	
	Monolithic Ceramic Capacitors	GJM Series	High Frequency Filter Circuit	
	Resin External Electrode Monolithic Ceramic Capacitors	GRJ Series	Coupling/Decoupling/For Step-up	
	Polymer Aluminum Electrolytic Capacitors	ECAS Series	Smoothing/Transient Backup	
	Chip Inductors (Chip Coils)	LQW/LQP/LQG Series	High Frequency Circuit-Impedance Matching/Resonance	
	Chip Inductors (Chip Coils)	LQM/LQH/DFEC Series	Voltage Conversion	
	Chip Ferrite Beads	BLM Series	Noise Suppression	
	3 Terminal Capacitors	NFM Series	Noise Suppression	
	Feed Through Chip EMI Filters	NFE Series	Noise Suppression	
	Chip Common Mode Choke Coils	DLW/DLP Series	Noise Suppression	
	Microwave Absorbers	EA Series	Noise Suppression	
	Ferrite Cores	FS Series	Noise Suppression	
	Thin Type Sandwich Cores	FSSA Series	Noise Suppression	
	Small Energy Devices	UMAC Series	Battery Backup	

G-PON

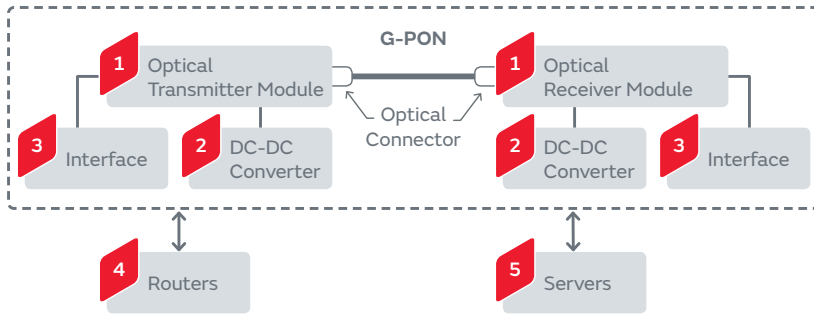

1 Optical Transmitter Module/Optical Receiver Module

Monolithic Ceramic Capacitors
(Top & Bottom Electrode Type
for Bonding)
GMA Series



Single Layer Microchip Capacitors
CLB Series



Monolithic Ceramic Capacitors
(Compatible to Bonding/
AuSn Soldering)
GMD Series



Thin Film Circuit Substrate RUSUB®
RUCYT Series



2 DC-DC Converter

DC-DC Converters
MYB Series



DC-DC Converters
OKL Series



Micro DC-DC Converters
LXDC Series



Polymer Aluminum Electrolytic Capacitors
ECAS Series



Thermistors
PRF Series



3 Interface

Low ESL Monolithic Ceramic Capacitors
LLL/LLA/LLM Series



Crystal Units/Crystal Oscillators



Chip Common Mode Choke Coils
DLW/DLP Series



ESD Protection Devices
LXES Series



4 Routers

Low ESL Monolithic
Ceramic Capacitors
LLL/LLA/LLM Series



High Temperature Guaranteed
Low Loss Lead Type Ceramic Capacitor
DEA Series



Monolithic Ceramic Capacitors
(Compatible to Bonding/AuSn Soldering)
GMD Series



Supercapacitors (EDLC)
DMF/DMT Series



Monolithic Ceramic Capacitors
for Medium Voltage
GR/GA Series



Monolithic Ceramic Capacitors
(Top & Bottom Electrode Type
for Bonding)
GMA Series



Crystal Units/
Crystal Oscillators



Chip Common Mode Choke Coils
DLW/DLP Series



5 Servers

Shock Sensors
PKGS Series



Supercapacitors (EDLC)
DMF/DMT Series



Polymer Aluminum
Electrolytic Capacitors
ECAS Series



Crystal Units/Crystal Oscillators



General Purpose	Monolithic Ceramic Capacitors	GRM Series	Coupling/Decoupling/For Step-up	
	Monolithic Ceramic Capacitors	GJM Series	High Frequency Filter Circuit	
	Resin External Electrode Monolithic Ceramic Capacitors	GRJ Series	Coupling/Decoupling/For Step-up	
	Polymer Aluminum Electrolytic Capacitors	ECAS Series	Smoothing/Transient Backup	
	Chip Inductors (Chip Coils)	LQW/LQP/LQG Series	High Frequency Circuit-Impedance Matching/Resonance	
	Chip Inductors (Chip Coils)	LQM/LQH/DFEC Series	Voltage Conversion	
	Chip Ferrite Beads	BLM Series	Noise Suppression	
	3 Terminal Capacitors	NFM Series	Noise Suppression	
	Feed Through Chip EMI Filters	NFE Series	Noise Suppression	
	Chip Common Mode Choke Coils	DLW/DLP Series	Noise Suppression	
	Microwave Absorbers	EA Series	Noise Suppression	
	Ferrite Cores	FS Series	Noise Suppression	
	Thin Type Sandwich Cores	FSSA Series	Noise Suppression	
Small Energy Devices	UMAC Series	Battery Backup		

Data Center

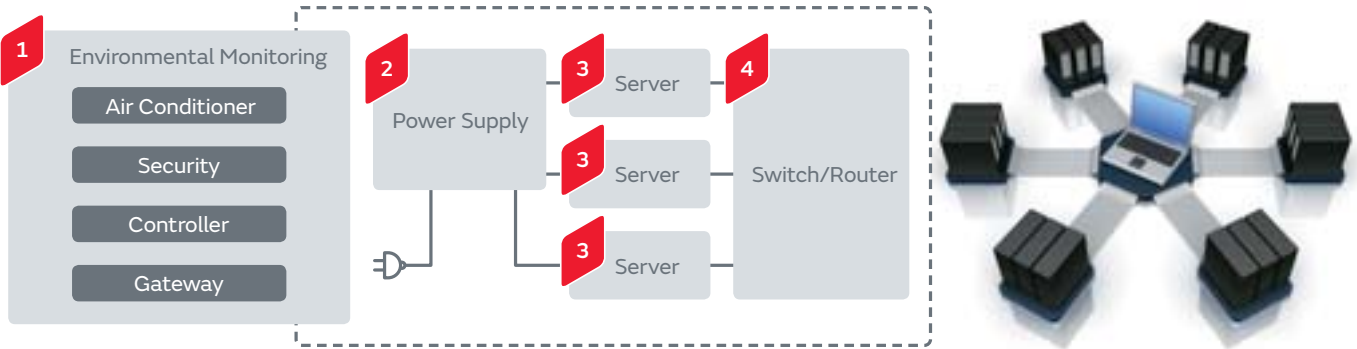

1 Environmental Monitoring

- Wi-Fi® Modules
- Sub-GHz Modules
- Magnetic Sensors (AMR Sensors) MR Series
- Pressure Sensors ZPA Series
- Shock Sensors PKGS Series
- Thermistors NCP Series

2 Power Supply

- 3-phase PFC Converters MPA Series
- DC-DC Converters for High Voltage Direct Current (HVDC) MPA Series

3 Server

- Shock Sensors PKGS Series
- Isolated DC-DC Converters MYB Series
- Non-isolated DC-DC Converters OKL/MPDR/MPDT Series
- Supercapacitors (EDLC) DMT Series
- Polymer Aluminum Electrolytic Capacitors ECAS Series
- Crystal Units/ Crystal Oscillators

4 Switch/Router

- Isolated DC-DC Converters MYB Series
- Non-isolated DC-DC Converters OKL/MPDR/MPDT Series
- Low ESL Monolithic Ceramic Capacitors LLL/LLA/LLM Series
- Monolithic Ceramic Capacitors for Medium Voltage GR/GA Series
- High Temperature Guaranteed Low Loss Lead Type Ceramic Capacitor DEA Series
- Monolithic Ceramic Capacitors (Top & Bottom Electrode Type for Bonding) GMA Series
- Monolithic Ceramic Capacitors (Compatible to Bonding /AuSn Soldering) GMD Series
- Crystal Units/ Crystal Oscillators
- Supercapacitors (EDLC) DMF Series
- Chip Common Mode Choke Coils DLW/DLP Series

General Purpose	Monolithic Ceramic Capacitors	GRM Series	Coupling/Decoupling/For Step-up	
	Monolithic Ceramic Capacitors	GJM Series	High Frequency Filter Circuit	
	Resin External Electrode Monolithic Ceramic Capacitors	GRJ Series	Coupling/Decoupling/For Step-up	
	Polymer Aluminum Electrolytic Capacitors	ECAS Series	Smoothing/Transient Backup	
	Chip Inductors (Chip Coils)	LQW/LQP/LQG Series	High Frequency Circuit-Impedance Matching/Resonance	
	Chip Inductors (Chip Coils)	LQM/LQH/DFEC Series	Voltage Conversion	
	Chip Ferrite Beads	BLM Series	Noise Suppression	
	3 Terminal Capacitors	NFM Series	Noise Suppression	
	Feed Through Chip EMI Filters	NFE Series	Noise Suppression	
	Chip Common Mode Choke Coils	DLW/DLP Series	Noise Suppression	
	Microwave Absorbers	EA Series	Noise Suppression	
	Ferrite Cores	FS Series	Noise Suppression	
	Thin Type Sandwich Cores	FSSA Series	Noise Suppression	
Small Energy Devices	UMAC Series	Battery Backup		

Automotive

Powertrain/Safety

- 1 ECU
- 2 AT
- 3 Auxilliary Motors
- 4 TPMS
- 5 ABS/ESC
- 6 Headlamp
- 7 EPS
- 8 Fuel Injection System



1 ECU

Low Temperature Co-fired Ceramics (LTCC) Ceramic Multilayer Substrates LFC®



Metal Terminal Type Monolithic Ceramic Capacitors KCM Series



Monolithic Ceramic Capacitors for Automotive GCM Series



Resin External Electrode Monolithic Ceramic Capacitors GCJ Series



Monolithic Ceramic Capacitor for Conductive Adhesives GCG Series



Monolithic Ceramic Capacitor for Conductive Adhesives (Ni/Pd Plating Structure) GCB Series



Radial Lead Type Monolithic Ceramic Capacitors RH Series



Ceramic Resonators CERALOCK® CSTCE/CSTCR Series



Crystal Units XRCGB/XRCHA Series



Accelerometers SCA Series



Gyro Sensors SCC Series



Thermistors PRF/PTG Series



2 AT

Low Temperature Co-fired Ceramics (LTCC) Ceramic Multilayer Substrates LFC®



Metal Terminal Type Monolithic Ceramic Capacitors KCM Series

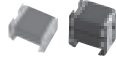

Ceramic Resonators CERALOCK® CSTCE/CSTCR Series



Crystal Units XRCGB/XRCHA Series



Accelerometers SCA Series



Thermistors PRF/PTG Series



3 Auxiliary Motors

Low Temperature Co-fired Ceramics (LTCC) Ceramic Multilayer Substrates LFC®



DC-DC Converters

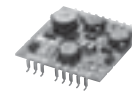

Metal Terminal Type Monolithic Ceramic Capacitors KCM Series



Radial Lead Type Monolithic Ceramic Capacitors RH Series



Ceramic Resonators CERALOCK® CSTCE/CSTCR Series



Large Current Common Mode Choke Coils PLT10HH Series



Thermistors PRF/PTG Series



4 TPMS

Shock Sensors PKGS Series



Ceramic Filters CERAFIL® SFEFCF Series



Ceramic Discriminators CDSDB Series



Ceramic Resonators CERALOCK® CSTCE/CSTCR Series



Crystal Units XRCGB/XRCHA Series



Pressure Sensor Elements SCB10H Series



Thermistors PRF Series



Transponder Coils SA3M08 Series



5 ABS/ESC

Low Temperature Co-fired Ceramics (LTCC) Ceramic Multilayer Substrates LFC®

Metal Terminal Type Monolithic Ceramic Capacitors KCM Series

Monolithic Ceramic Capacitors for Automotive GCM Series

Resin External Electrode Monolithic Ceramic Capacitors GCJ Series

Monolithic Ceramic Capacitor for Conductive Adhesives GCG Series

Monolithic Ceramic Capacitor for Conductive Adhesives (Ni/Pd Plating Structure) GCB Series

Ceramic Resonators CERALOCK® CSTCE/CSTCR Series

Crystal Units XRCGB/XRCHA Series

Accelerometers SCA Series

Gyro Sensors SCC Series

Thermistors for Conductive Glue Mounting NCG18 Series

6 Headlamp

Low Temperature Co-fired Ceramics (LTCC) Ceramic Multilayer Substrates LFC®

Monolithic Ceramic Capacitors for Automotive GCM Series

Resin External Electrode Monolithic Ceramic Capacitors GCJ Series

Ceramic Resonators CERALOCK® CSTCE/CSTCR Series

Crystal Units XRCGB/XRCHA Series

Thermistors for Conductive Glue Mounting NCG18 Series

7 EPS

Low Temperature Co-fired Ceramics (LTCC) Ceramic Multilayer Substrates LFC®

Metal Terminal Type Monolithic Ceramic Capacitors KCM Series

Monolithic Ceramic Capacitors for Automotive GCM Series

Resin External Electrode Monolithic Ceramic Capacitors GCJ Series

Monolithic Ceramic Capacitor for Conductive Adhesives GCG Series

Monolithic Ceramic Capacitor for Conductive Adhesives (Ni/Pd Plating Structure) GCB Series

Radial Lead Type Monolithic Ceramic Capacitors RCE Series

Ceramic Resonators CERALOCK® CSTCE/CSTCR Series

Crystal Units XRCGB/XRCHA Series

Thermistors for Conductive Glue Mounting NCG18 Series

Accelerometers SCA Series

Gyro Sensors SCC Series

Thermistors PRF/PTG Series

8 Fuel Injection System

Radial Lead Type Monolithic Ceramic Capacitors RPF Series

General Purpose (High Reliability)	Monolithic Ceramic Capacitors For Automotive	GCM Series	Coupling/Decoupling		150°C
	Radial Lead Type Monolithic Ceramic Capacitors	RCE Series	Noise Suppression/Decoupling		125°C
	Radial Lead Type Monolithic Ceramic Capacitors	RH Series	Noise Suppression/Decoupling		150°C
	Chip Inductors (Chip Coils)	LQH32CH/MBH/DFEH Series	Voltage Conversion		105°C
	Chip Inductors (Chip Coils)	LQG15HH Series	Impedance Matching/Choke		125°C
	Chip Ferrite Beads	BLM_SH Series	Noise Suppression		125°C
	3 Terminal Capacitors	NFM_H/NFE_H Series	Noise Suppression		125°C
	Chip Common Mode Choke Coils	DLW31/DLW43 Series	Common Mode Noise Suppression		125°C

105°C 105°C max. 125°C 125°C max. 150°C 150°C max.

HEV/PHEV/EV

1

Charger

2

BMS

3

Electrically-Driven Compressor

4

Electric Pump

5

Inverter

6

DC-DC Converter



1 Charger

Metal Terminal Type Monolithic Ceramic Capacitors KCM Series

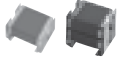

Monolithic Ceramic Capacitors for Automotive GCM Series



Resin External Electrode Monolithic Ceramic Capacitors GCJ Series



Safety Standard Certified Ceramic Capacitors Type KJ



Ceramic Resonators CERALOCK® CSTCE Series



Crystal Units XRCGB/XRCHA Series



Large Current Common Mode Choke Coils PLT10HH Series



Thermistors PRF/PTG Series



2 BMS

DC-DC Converters

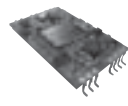

Metal Terminal Type Monolithic Ceramic Capacitors KCM Series



Monolithic Ceramic Capacitors for Automotive GCM Series



Resin External Electrode Monolithic Ceramic Capacitors GCJ Series



Monolithic Ceramic Capacitor for Conductive Adhesives GCG Series



Monolithic Ceramic Capacitor for Conductive Adhesives (Ni/Pd Plating Structure) GCB Series



Ceramic Resonators CERALOCK® CSTCE Series



Crystal Units XRCGB/XRCHA Series



Thermistors PRF/PTG Series



3 Electrically-driven Compressor

Metal Terminal Type Monolithic Ceramic Capacitors KCM Series



Resin External Electrode Monolithic Ceramic Capacitors GCJ Series



Monolithic Ceramic Capacitors for Automotive GCM Series



Monolithic Ceramic Capacitor for Conductive Adhesives GCG Series



Monolithic Ceramic Capacitor for Conductive Adhesives (Ni/Pd Plating Structure) GCB Series



Thermistors PRF/PTG Series



Ceramic Resonators CERALOCK® CSTCE/CSTCR Series



Crystal Units XRCGB/XRCHA Series



4 Electric Pump

Metal Terminal Type Monolithic Ceramic Capacitors KCM Series

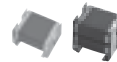

Monolithic Ceramic Capacitors for Automotive GCM Series



Resin External Electrode Monolithic Ceramic Capacitors GCJ Series



Monolithic Ceramic Capacitor for Conductive Adhesives GCG Series



Low Temperature Co-fired Ceramics (LTCC) Ceramic Multilayer Substrates LFC®



Large Current Common Mode Choke Coils PLT10HH Series



Thermistors PRF/PTG Series



Ceramic Resonators CERALOCK® CSTCE/CSTCR Series



Crystal Units XRCGB/XRCHA Series



5 Inverter

Metal Terminal Type Monolithic Ceramic Capacitors KCM Series

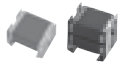

Monolithic Ceramic Capacitors for Automotive GCM Series



Resin External Electrode Monolithic Ceramic Capacitors GCJ Series



Monolithic Ceramic Capacitor for Conductive Adhesives GCG Series



Monolithic Ceramic Capacitor for Conductive Adhesives (Ni/Pd Plating Structure) GCB Series



Radial Lead Type Monolithic Ceramic Capacitors RH Series



Large Current Common Mode Choke Coils PLT10HH Series



Thermistors PRF/PTG Series



Ceramic Resonators CERALOCK® CSTCE/CSTCR Series



Crystal Units XRCGB/XRCHA Series



6 DC-DC Converter

Metal Terminal Type Monolithic Ceramic Capacitors KCM Series

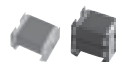

Monolithic Ceramic Capacitors for Automotive GCM Series



Resin External Electrode Monolithic Ceramic Capacitors GCJ Series



Monolithic Ceramic Capacitor for Conductive Adhesives GCG Series



Ceramic Resonators CERALOCK® CSTCE/CSTCR Series

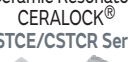

Monolithic Ceramic Capacitor for Conductive Adhesives (Ni/Pd Plating Structure) GCB Series



Crystal Units XRCGB/XRCHA Series



Large Current Common Mode Choke Coils PLT10HH Series



Thermistors PRF/PTG Series



Please refer to p.95 for General Purpose (High Reliability).

Information/Comfort/Accessory

1 Navigation/
Infotainment

2 Remote Keyless Entry

3 Meter/HUD

4 Power Seat/
Power Mirror

5 Parking Assist



1 Navigation/Infotainment

Rotary Position Sensors
SV Series



Accelerometers
SCA Series



Supercapacitors (EDLC)
DMF/DMT Series



Ceramic Filters CERAFIL®
SFEFCF Series



Piezoelectric Sounders
PKLCS Series



Bluetooth® Modules

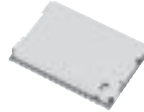

Wi-Fi® Modules



DC-DC Converters

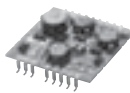

Ceramic Resonators
CERALOCK®
CSTCE/CSTCR Series



Crystal Units
XRCGB/XRCHA Series



Thermistors
PRF/PRG/PTG Series



Chip Multilayer Diplexers
LFD Series



Chip Multilayer LC Filters
LF Series



Chip Multilayer Hybrid Baluns
LDB/LDM Series



Chip Multilayer Hybrid Couplers
LDC/LDJ Series



2 Remote Keyless Entry

Transponder Coils
SAZ73D/SA3D14/SA3D12/SA3M08/STA8121 Series

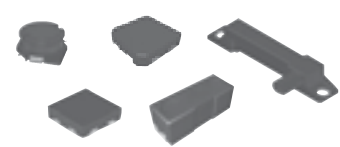

Supercapacitors (EDLC)
DMF/DMT Series



Small Energy Devices
UMAC Series



Ceramic Filters CERAFIL®
SFEFCF Series



Ceramic Resonators
CERALOCK®
CSTCE/CSTCR Series



Piezoelectric Sounders
PKLCS Series



Crystal Units
XRCGB/XRCHA Series



3 Meter/HUD

Rotary Position Sensors
SV Series



DC-DC Converters



Ceramic Resonators CERALOCK®
CSTCE/CSTCR Series



Crystal Units
XRCGB/XRCHA Series



Piezoelectric Sounders
PKM/PKLCS Series



Thermistors
PRF/PTG Series



4 Power Seat/Power Mirror

Piezoelectric Sounders
PKLCS Series



Ceramic Resonators CERALOCK®
CSTCE/CSTCR Series



Crystal Units
XRCGB/XRCHA Series



Thermistors
PRF/PTG Series



5 Parking Assist

Ultrasonic Sensors
MA Series



Accelerometers
SCA Series



Supercapacitors (EDLC)
DMF/DMT Series



Piezoelectric Sounders
PKM/PKLCS Series



Ceramic Resonators CERALOCK®
CSTCE/CSTCR Series



Crystal Units
XRCGB/XRCHA Series



Thermistors
PRF/PTG Series



Please refer to p.99 for General Purpose.

Bike/EV Bike

Electromotive

1

Charger/Battery

2

Inverter

3

DC-DC Converter

Electric Installation

4

Accelerometer
for Fuel Cut

5

Headlamp

6

Fuel Injection System



1 Charger/Battery

Lithium Ion Storage Modules



Metal Terminal Type
Monolithic Ceramic Capacitors
KCM Series

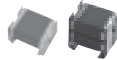

Monolithic Ceramic
Capacitors for Automotive
GCM Series



Resin External Electrode
Monolithic Ceramic Capacitors
GCJ Series



Safety Standard Certified
Ceramic Capacitors
Type KJ



Ceramic Resonators
CERALOCK®
CSTCE Series



Crystal Units
XRCGB/XRCHA Series



Large Current Common Mode Choke Coils
PLT10HH Series



Thermistors
PRF/PTG Series



3 DC-DC Converter

DC-DC Converters



Metal Terminal Type
Monolithic Ceramic Capacitors
KCM Series



Monolithic Ceramic
Capacitors for Automotive
GCM Series



Resin External
Electrode Monolithic
Ceramic Capacitors
GCJ Series



Monolithic Ceramic Capacitor
for Conductive Adhesives
GCG Series



Monolithic Ceramic Capacitor
for Conductive Adhesives
(Ni/Pd Plating Structure)
GCB Series



Ceramic Resonators
CERALOCK®
CSTCE/CSTCR Series



Crystal Units
XRCGB/XRCHA Series



Large Current Common Mode
Choke Coils
PLT10HH Series



Thermistors
PRF/PTG Series



2 Inverter

Monolithic Ceramic
Capacitors for Automotive
GCM Series



Resin External Electrode
Monolithic Ceramic Capacitors
GCJ Series



Monolithic Ceramic Capacitor
for Conductive Adhesives
GCG Series



Monolithic Ceramic Capacitor
for Conductive Adhesives
(Ni/Pd Plating Structure)
GCB Series



Radial Lead Type
Monolithic Ceramic Capacitors
RH Series



Large Current Common Mode
Choke Coils
PLT10HH Series



Ceramic Resonators CERALOCK®
CSTCE/CSTCR Series



Crystal Units
XRCGB/XRCHA Series











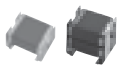

Thermistors
PRF/PTG Series







General Purpose (High Reliability)	Monolithic Ceramic Capacitors For Automotive	GCM Series	Coupling/Decoupling		150°C
	Radial Lead Type Monolithic Ceramic Capacitors	RCE Series	Noise Suppression/Decoupling		125°C
	Radial Lead Type Monolithic Ceramic Capacitors	RH Series	Noise Suppression/Decoupling		150°C
	Chip Inductors (Chip Coils)	LQH32CH/MBH/DFEH Series	Voltage Conversion		105°C
	Chip Inductors (Chip Coils)	LQG15HH Series	Impedance Matching/Choke		125°C
	Chip Ferrite Beads	BLM_SH Series	Noise Suppression		125°C
	3 Terminal Capacitors	NFM_H/NFE_H Series	Noise Suppression		125°C
	Chip Common Mode Choke Coils	DLW31/DLW43 Series	Common Mode Noise Suppression		125°C

105°C 105°C max. 125°C 125°C max. 150°C 150°C max.









4 Accelerometer for Fuel Cut

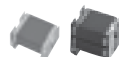







<p>Metal Terminal Type Monolithic Ceramic Capacitors KCM Series</p> 	<p>Monolithic Ceramic Capacitors for Automotive GCM Series</p> 	<p>Resin External Electrode Monolithic Ceramic Capacitors GCJ Series</p> 	<p>Monolithic Ceramic Capacitor for Conductive Adhesives GCG Series</p> 	<p>Monolithic Ceramic Capacitor for Conductive Adhesives (Ni/Pd Plating Structure) GCB Series</p> 
<p>Ceramic Resonators CERALOCK® CSTCE/CSTCR Series</p> 	<p>Crystal Units XRCGB/XRCHA Series</p> 	<p>Accelerometers SCA Series</p> 	<p>Gyro Sensors SCC Series</p> 	<p>Thermistors for Conductive Glue Mounting NCG18 Series</p> 

5 Headlamp

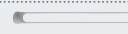
<p>Monolithic Ceramic Capacitors for Automotive GCM Series</p> 	<p>Resin External Electrode Monolithic Ceramic Capacitors GCJ Series</p> 
<p>Ceramic Resonators CERALOCK® CSTCE/CSTCR Series</p> 	<p>Crystal Units XRCGB/XRCHA Series</p> 
<p>Thermistors for Conductive Glue Mounting NCG18 Series</p> 	

6 Fuel Injection System

<p>Metal Terminal Type Monolithic Ceramic Capacitors KCM Series</p> 	<p>Monolithic Ceramic Capacitors for Automotive GCM Series</p> 	<p>Resin External Electrode Monolithic Ceramic Capacitors GCJ Series</p> 
<p>Monolithic Ceramic Capacitor for Conductive Adhesives GCG Series</p> 	<p>Monolithic Ceramic Capacitor for Conductive Adhesives (Ni/Pd Plating Structure) GCB Series</p> 	<p>Ceramic Resonators CERALOCK® CSTCE/CSTCR Series</p> 
<p>Crystal Units XRCGB/XRCHA Series</p> 		<p>Thermistors PRF/PTG Series</p> 

General Purpose	Monolithic Ceramic Capacitors	GRT Series	Coupling/Decoupling	
	Monolithic Ceramic Capacitors for Medium Voltage	GRM Series	For Snubber	
	Resin External Electrode Monolithic Ceramic Capacitors	GRJ Series	Coupling/Decoupling/For Step-up	
	Radial Lead Type Monolithic Ceramic Capacitors	RCE Series	Noise Suppression/Decoupling	
	Chip Inductors (Chip Coils)	LQM/LQH/DFEC Series	Voltage Conversion	
	Chip Ferrite Beads	BLM Series	Noise Suppression	
	EMI Suppression Filters	NFL/NFE Series	Noise Suppression	
	Chip Common Mode Choke Coils	DLW Series	Common Mode Noise Suppression	
	Ferrite Cores	FS Series	Noise Suppression	

Air Conditioner

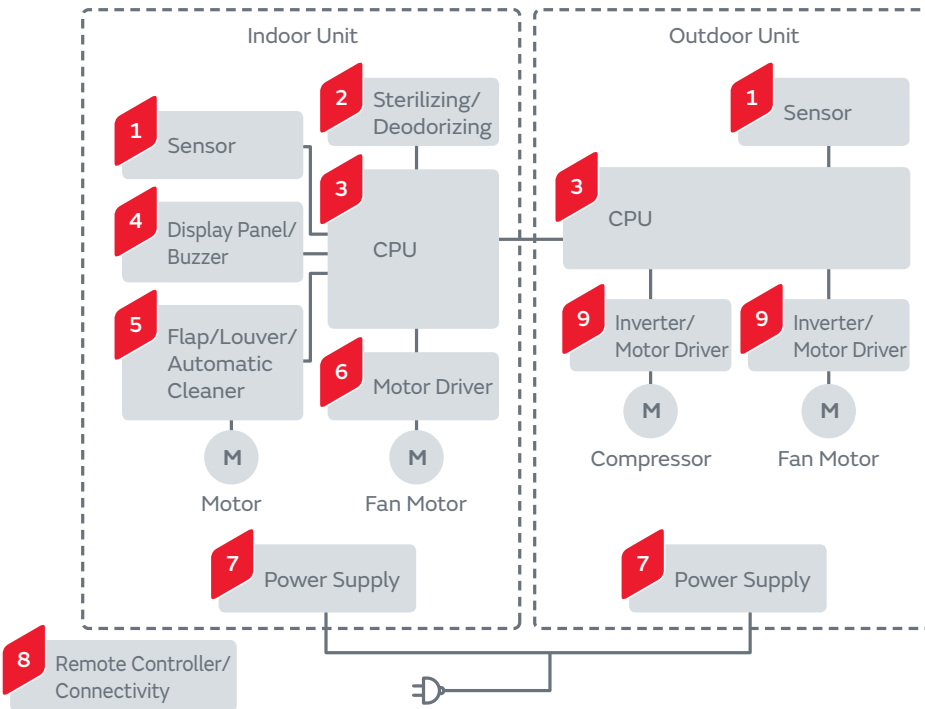

1 Sensor

Pyroelectric Infrared Sensors IRA Series

Ultrasonic Sensors MA Series

Thermistors NCP/NXR/PRF Series

2 Sterilizing/Deodorizing

Ionizer Modules Ionissimo® MHM300 Series

Ozonizer Modules Ionissimo® MHM500 Series

High Voltage Power MPH4602 Series

High Voltage Resistors MHR Series

3 CPU

Ceramic Resonators CERALOCK® CSTLS/CSTCE/CSTCR Series

4 Display Panel/Buzzer

Ceramic Resonators CERALOCK® CSTLS/CSTCE/CSTCR Series

Piezoelectric Sounders PKM/PKLC Series

5 Flap/Louver/Automatic Cleaner

Rotary Position Sensors SV Series

6 Motor Driver

Thermistors NCP/NXR/PRF Series

7 Power Supply

Monolithic Ceramic Capacitors for Medium Voltage GR/GA Series

High Temperature Guaranteed Low Loss Lead Type Ceramic Capacitor DEA Series

Safety Standard Certified Ceramic Capacitors Type KX/KY

Thermistors NTP/PTG Series

8 Remote Controller/Connectivity

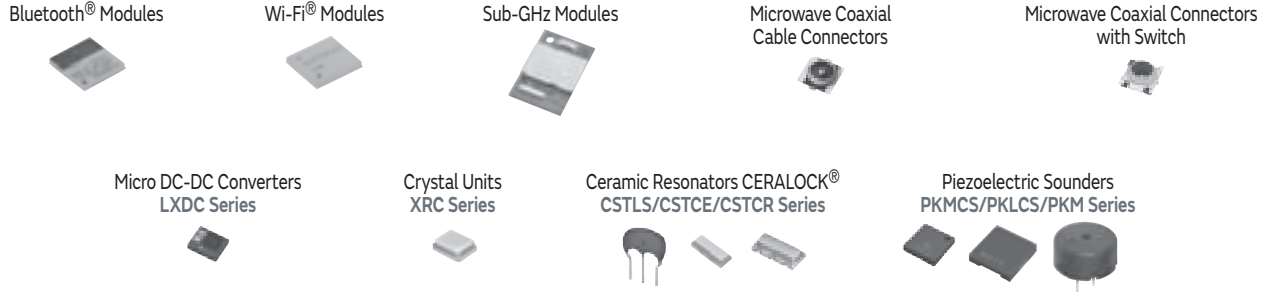

9 Inverter/Motor Driver



General Purpose	Monolithic Ceramic Capacitors	GRM Series	Coupling/Decoupling/For Step-up	
	Monolithic Ceramic Capacitors	GJM Series	High Frequency Filter Circuit	
	Resin External Electrode Monolithic Ceramic Capacitors	GRJ Series	Coupling/Decoupling/For Step-up	
	Polymer Aluminum Electrolytic Capacitors	ECAS Series	Smoothing/Transient Backup	
	Chip Inductors (Chip Coils)	LQW/LQP/LQG Series	High Frequency Circuit-Impedance Matching/Resonance	
	Chip Inductors (Chip Coils)	LQM/LQH/DFEC Series	Voltage Conversion	
	Chip Ferrite Beads	BLM Series	Noise Suppression	
	3 Terminal Capacitors	NFM Series	Noise Suppression	
	Feed Through Chip EMI Filters	NFE Series	Noise Suppression	
	Chip Common Mode Choke Coils	DLW/DLP Series	Noise Suppression	
	Microwave Absorbers	EA Series	Noise Suppression	
	Ferrite Cores	FS Series	Noise Suppression	
	Thin Type Sandwich Cores	FSSA Series	Noise Suppression	
	Small Energy Devices	UMAC Series	Battery Backup	

Refrigerator



1 Sensor

Pyroelectric Infrared Sensors
IRA Series



Thermistors
NCP/NXR/PRF Series

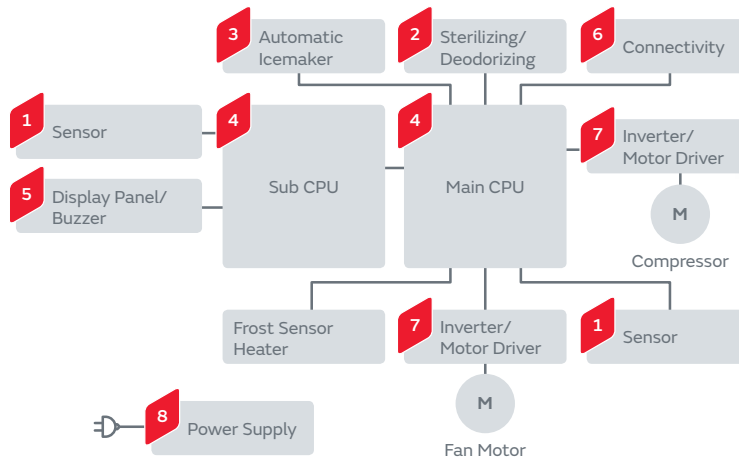

2 Sterilizing/Deodorizing

Ionizer Modules Ionissimo®
MHM300 Series

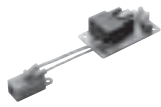

Ozonizer Modules Ionissimo®
MHM500 Series

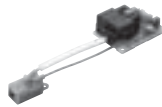

High Voltage Power
MPH4602 Series



High Voltage Resistors
MHR Series



Microblowers

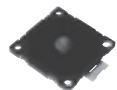

3 Automatic Icemaker

Microblowers

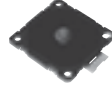

4 CPU

Ceramic Resonators
CERALOCK®
CSTLS/CSTCE/CSTCR Series



5 Display Panel/Buzzer

Ceramic Resonators
CERALOCK®
CSTLS/CSTCE/CSTCR Series



Piezoelectric Sounders
PKM/PKLC Series

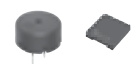

6 Connectivity

Bluetooth® Modules



Wi-Fi® Modules



Sub-GHz Modules



Microwave Coaxial
Cable Connectors



Microwave
Coaxial Connectors
with Switch



Micro DC-DC Converters
LXDC Series



Crystal Units
XRC Series



7 Inverter/Motor Driver

Thermistors
NCP/NXR/PRF Series



Ceramic Resonators CERALOCK®
CSTLS/CSTCE/CSTCR Series



8 Power Supply

Monolithic Ceramic Capacitors
for Medium Voltage
GR/GA Series



High Temperature
Guaranteed Low
Loss Lead Type
Ceramic Capacitor
DEA Series

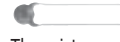

Safety Standard Certified
Ceramic Capacitors
Type KX/KY



Thermistors
NTP/PTG Series



General Purpose

Monolithic Ceramic Capacitors	GRM Series	Coupling/Decoupling/For Step-up	
Monolithic Ceramic Capacitors	GJM Series	High Frequency Filter Circuit	
Resin External Electrode Monolithic Ceramic Capacitors	GRJ Series	Coupling/Decoupling/For Step-up	
Polymer Aluminum Electrolytic Capacitors	ECAS Series	Smoothing/Transient Backup	
Chip Inductors (Chip Coils)	LQW/LQP/LQG Series	High Frequency Circuit-Impedance Matching/Resonance	
Chip Inductors (Chip Coils)	LQM/LQH/DFEC Series	Voltage Conversion	
Chip Ferrite Beads	BLM Series	Noise Suppression	
3 Terminal Capacitors	NFM Series	Noise Suppression	
Feed Through Chip EMI Filters	NFE Series	Noise Suppression	
Chip Common Mode Choke Coils	DLW/DLP Series	Noise Suppression	
Microwave Absorbers	EA Series	Noise Suppression	
Ferrite Cores	FS Series	Noise Suppression	
Thin Type Sandwich Cores	FSSA Series	Noise Suppression	
Small Energy Devices	UMAC Series	Battery Backup	

Washing Machine

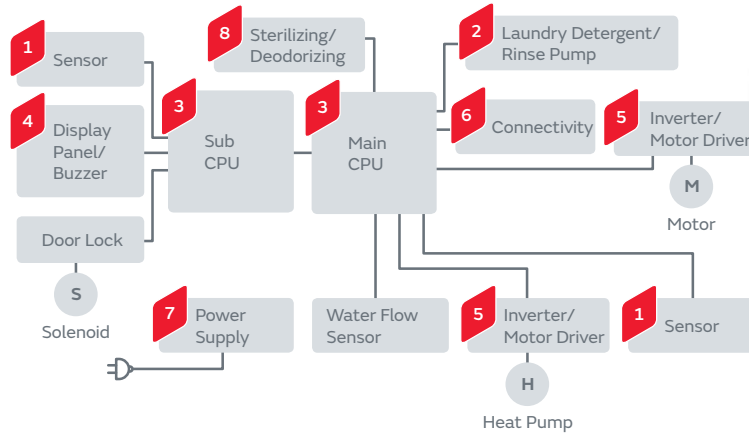

1 Sensor

Thermistors
NCP/NXR/PRF Series

2 Laundry Detergent/Rinse Pump

Microblowers

3 CPU

Ceramic Resonators
CERALOCK®
CSTLS/CSTCE/CSTCR Series

4 Display Panel/Buzzer

Rotary Position Sensors SV Series

Ceramic Resonators CERALOCK®
CSTLS/CSTCE/CSTCR Series

Piezoelectric Sounders PKM/PKLC Series

5 Inverter/Motor Driver

Thermistors
NCP/NXR/PRF Series

6 Connectivity

Bluetooth® Modules

Wi-Fi® Modules

Sub-GHz Modules

Microwave Coaxial Cable Connectors

Microwave Coaxial Connectors with Switch

DC-DC Converters LXDC Series

Crystal Units XRC Series

7 Power Supply

Monolithic Ceramic Capacitors for Medium Voltage GR/GA Series

High Temperature Guaranteed Low Loss Lead Type Ceramic Capacitor DEA Series

Safety Standard Certified Ceramic Capacitors Type KX/KY

Thermistors NTP/PTG Series

8 Sterilizing/Deodorizing

Ozonizer Modules Ionissimo® MHM500 Series

High Voltage Power MPH4602 Series

General Purpose	Monolithic Ceramic Capacitors	GRM Series	Coupling/Decoupling/For Step-up	
	Monolithic Ceramic Capacitors	GJM Series	High Frequency Filter Circuit	
	Resin External Electrode Monolithic Ceramic Capacitors	GRJ Series	Coupling/Decoupling/For Step-up	
	Polymer Aluminum Electrolytic Capacitors	ECAS Series	Smoothing/Transient Backup	
	Chip Inductors (Chip Coils)	LQW/LQP/LQG Series	High Frequency Circuit-Impedance Matching/Resonance	
	Chip Inductors (Chip Coils)	LQM/LQH/DFEC Series	Voltage Conversion	
	Chip Ferrite Beads	BLM Series	Noise Suppression	
	3 Terminal Capacitors	NFM Series	Noise Suppression	
	Feed Through Chip EMI Filters	NFE Series	Noise Suppression	
	Chip Common Mode Choke Coils	DLW/DLP Series	Noise Suppression	
	Microwave Absorbers	EA Series	Noise Suppression	
	Ferrite Cores	FS Series	Noise Suppression	
	Thin Type Sandwich Cores	FSSA Series	Noise Suppression	
Small Energy Devices	UMAC Series	Battery Backup		

Air Purifier

1 Sensor

Pyroelectric Infrared Sensors IRA Series
 Ultrasonic Sensors MA Series
 Thermistors NCP/NXR/PRF Series

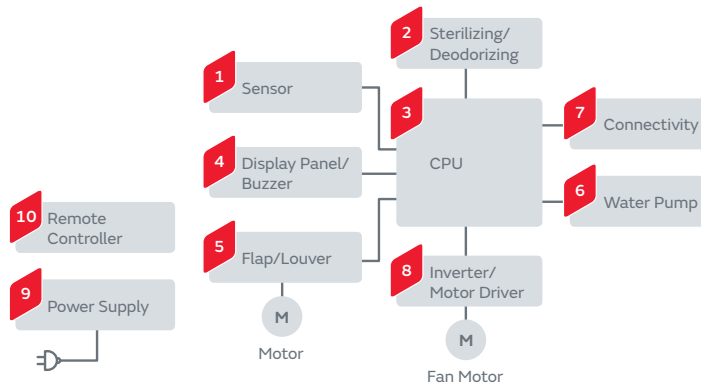

2 Sterilizing/Deodorizing

Ionizer Modules Ionissimo®
 MHM300 Series



Ozonizer Modules Ionissimo®
 MHM500 Series



High Voltage Power
 MPH4602 Series



High Voltage Resistors
 MHR Series



4 Display Panel/Buzzer

Ceramic Resonators CERALOCK®
 CSTLS/CSTCE/CSTCR Series



Piezoelectric Sounders
 PKM/PKLC Series



5 Flap/Louver

Rotary Position Sensors
 SV Series



6 Water Pump

Microblowers



7 Connectivity

Bluetooth®
 Modules



Wi-Fi®
 Modules



Sub-GHz Modules



Microwave Coaxial
 Cable Connectors



Microwave Coaxial
 Connectors with Switch



Micro DC-DC Converters
 LXDC Series



Crystal Units
 XRC Series



9 Power Supply

Monolithic
 Ceramic Capacitors
 for Medium Voltage
 GR/GA Series



High Temperature
 Guaranteed Low Loss Lead Type
 Ceramic Capacitor
 DEA Series



Safety Standard Certified Ceramic Capacitors
 Type KX/KY



AC Line Filters
 PLA/PLY Series



Thermistors
 NTP/PTG Series



10 Remote Controller

Micro DC-DC
 Converters
 LXDC Series



Ceramic Resonators
 CERALOCK®
 CSTLS/CSTCE/CSTCR Series



Piezoelectric Sounders
 PKMCS/PKLC/SKM Series



General Purpose

Monolithic Ceramic Capacitors	GRM Series	Coupling/Decoupling/For Step-up	
Monolithic Ceramic Capacitors	GJM Series	High Frequency Filter Circuit	
Resin External Electrode Monolithic Ceramic Capacitors	GRJ Series	Coupling/Decoupling/For Step-up	
Polymer Aluminum Electrolytic Capacitors	ECAS Series	Smoothing/Transient Backup	
Chip Inductors (Chip Coils)	LQW/LQP/LQG Series	High Frequency Circuit-Impedance Matching/Resonance	
Chip Inductors (Chip Coils)	LQM/LQH/DFEC Series	Voltage Conversion	
Chip Ferrite Beads	BLM Series	Noise Suppression	
3 Terminal Capacitors	NFM Series	Noise Suppression	
Feed Through Chip EMI Filters	NFE Series	Noise Suppression	
Chip Common Mode Choke Coils	DLW/DLP Series	Noise Suppression	
Microwave Absorbers	EA Series	Noise Suppression	
Ferrite Cores	FS Series	Noise Suppression	
Thin Type Sandwich Cores	FSSA Series	Noise Suppression	
Small Energy Devices	UMAC Series	Battery Backup	

Microwave Oven

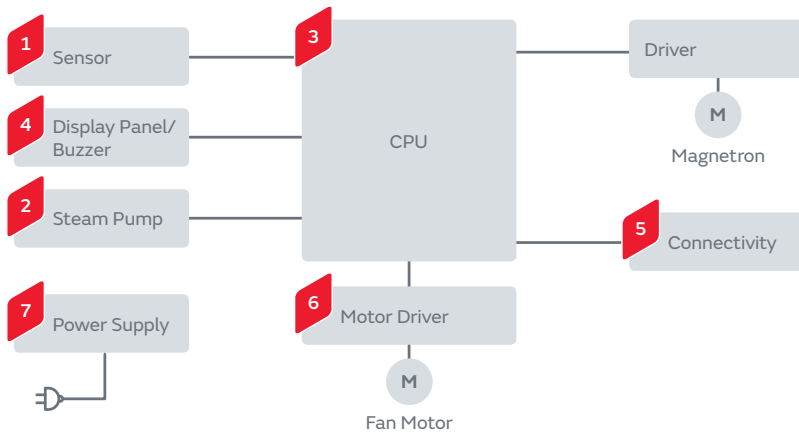

1 Sensor

Thermistors
NCP/NXR/PRF Series

2 Steam Pump

Microblowers

3 CPU

Ceramic Resonators CERALOCK®
CSTLS/CSTCE/CSTCR Series

4 Display Panel/Buzzer

Ceramic Resonators CERALOCK®
CSTLS/CSTCE/CSTCR Series

Piezoelectric Sounders
PKM/PKLC Series

5 Connectivity

Bluetooth® Modules

Wi-Fi® Modules

Sub-GHz Modules

Microwave Coaxial Cable Connectors

Microwave Coaxial Connectors with Switch

Micro DC-DC Converters LXDC Series

Crystal Units XRC Series

6 Motor Driver

Thermistors
NCP/NXR/PRF Series

7 Power Supply

Monolithic Ceramic Capacitors for Medium Voltage GR/GA Series

High Temperature Guaranteed Low Loss Lead Type Ceramic Capacitor DEA Series

Safety Standard Certified Ceramic Capacitors Type KX/KY

Thermistors NTP/PTG Series

General Purpose	Monolithic Ceramic Capacitors	GRM Series	Coupling/Decoupling/For Step-up	
	Monolithic Ceramic Capacitors	GJM Series	High Frequency Filter Circuit	
	Resin External Electrode Monolithic Ceramic Capacitors	GRJ Series	Coupling/Decoupling/For Step-up	
	Polymer Aluminum Electrolytic Capacitors	ECAS Series	Smoothing/Transient Backup	
	Chip Inductors (Chip Coils)	LQW/LQP/LQG Series	High Frequency Circuit-Impedance Matching/Resonance	
	Chip Inductors (Chip Coils)	LQM/LQH/DFEC Series	Voltage Conversion	
	Chip Ferrite Beads	BLM Series	Noise Suppression	
	3 Terminal Capacitors	NFM Series	Noise Suppression	
	Feed Through Chip EMI Filters	NFE Series	Noise Suppression	
	Chip Common Mode Choke Coils	DLW/DLP Series	Noise Suppression	
	Microwave Absorbers	EA Series	Noise Suppression	
	Ferrite Cores	FS Series	Noise Suppression	
	Thin Type Sandwich Cores	FSSA Series	Noise Suppression	
Small Energy Devices	UMAC Series	Battery Backup		

IH Rice Cooker

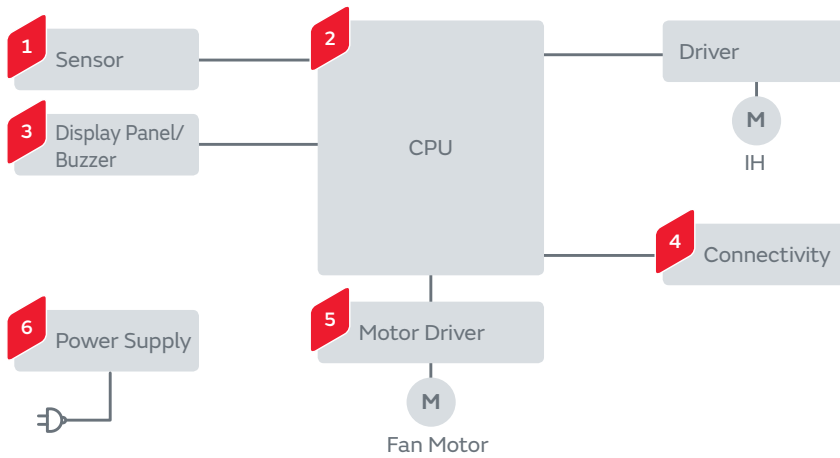

1 Sensor

Thermistors
NCP/NXR/PRF Series

3 Display Panel/Buzzer

Ceramic Resonators
CERALOCK®
CSTLS/CSTCE/CSTCR Series

Piezoelectric Sounders
PKM/PKLCS Series

4 Connectivity

Bluetooth® Modules Wi-Fi® Modules Sub-GHz Modules

Microwave Coaxial Cable Connectors Microwave Coaxial Connectors with Switch

Micro DC-DC Converters
LXDC Series Crystal Units
XRC Series

2 CPU

Ceramic Resonators
CERALOCK®
CSTLS/CSTCE/CSTCR Series

5 Motor Driver

Thermistors
NCP/NXR/PRF Series

6 Power Supply

Monolithic Ceramic Capacitors for Medium Voltage
GR/GA Series

High Temperature Guaranteed Low Loss Lead Type Ceramic Capacitor
DEA Series

Safety Standard Certified Ceramic Capacitors
Type KX/KY

Thermistors
NTP/PTG Series

General Purpose	Monolithic Ceramic Capacitors	GRM Series	Coupling/Decoupling/For Step-up	
	Monolithic Ceramic Capacitors	GJM Series	High Frequency Filter Circuit	
	Resin External Electrode Monolithic Ceramic Capacitors	GRJ Series	Coupling/Decoupling/For Step-up	
	Polymer Aluminum Electrolytic Capacitors	ECAS Series	Smoothing/Transient Backup	
	Chip Inductors (Chip Coils)	LQW/LQP/LQG Series	High Frequency Circuit-Impedance Matching/Resonance	
	Chip Inductors (Chip Coils)	LQM/LQH/DFEC Series	Voltage Conversion	
	Chip Ferrite Beads	BLM Series	Noise Suppression	
	3 Terminal Capacitors	NFM Series	Noise Suppression	
	Feed Through Chip EMI Filters	NFE Series	Noise Suppression	
	Chip Common Mode Choke Coils	DLW/DLP Series	Noise Suppression	
	Microwave Absorbers	EA Series	Noise Suppression	
	Ferrite Cores	FS Series	Noise Suppression	
	Thin Type Sandwich Cores	FSSA Series	Noise Suppression	
Small Energy Devices	UMAC Series	Battery Backup		

Vacuum Cleaner

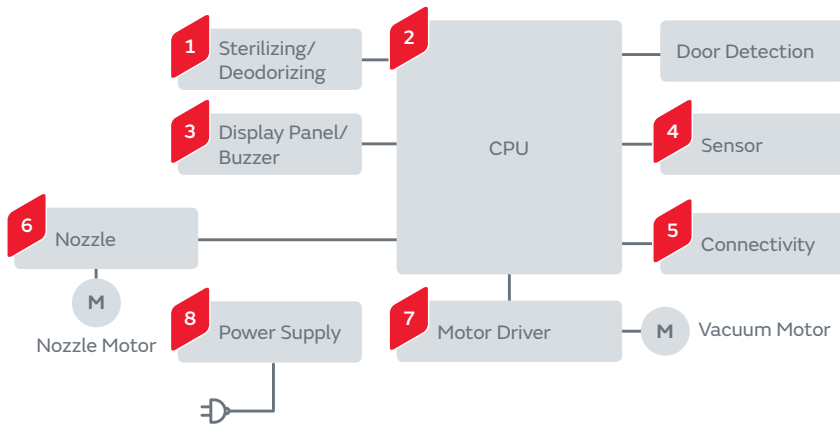

1 Sterilizing/Deodorizing

Ionizer Modules Ionissimo®
MHM300 Series

High Voltage Resistors
MHR Series

2 CPU

Ceramic Resonators CERALOCK®
CSTLS/CSTCE/CSTCR Series

3 Display Panel/Buzzer

Ceramic Resonators CERALOCK®
CSTLS/CSTCE/CSTCR Series

Piezoelectric Sounders
PKM/PKLC Series

4 Sensor

Ultrasonic Sensors
MA Series

Thermistors
NCP Series

5 Connectivity

Bluetooth® Modules

Wi-Fi® Modules

Crystal Units
XRC Series

Sub-GHz Modules

Microwave Coaxial Cable Connectors

Microwave Coaxial Connectors with Switch

Micro DC-DC Converters
LXDC Series

6 Nozzle

Thermistors
PTG Series

7 Motor Driver

Thermistors
NCP/NXR/PRF Series

8 Power Supply

Monolithic Ceramic Capacitors for Medium Voltage
GR/GA Series

High Temperature Guaranteed Low Loss Lead Type Ceramic Capacitor
DEA Series

Safety Standard Certified Ceramic Capacitors
Type KX/KY

Thermistors
NTP/PTG Series

General Purpose	Monolithic Ceramic Capacitors	GRM Series	Coupling/Decoupling/For Step-up	
	Monolithic Ceramic Capacitors	GJM Series	High Frequency Filter Circuit	
	Resin External Electrode Monolithic Ceramic Capacitors	GRJ Series	Coupling/Decoupling/For Step-up	
	Polymer Aluminum Electrolytic Capacitors	ECAS Series	Smoothing/Transient Backup	
	Chip Inductors (Chip Coils)	LQM/LQP/LQG Series	High Frequency Circuit-Impedance Matching/Resonance	
	Chip Inductors (Chip Coils)	LQM/LQH/DFEC Series	Voltage Conversion	
	Chip Ferrite Beads	BLM Series	Noise Suppression	
	3 Terminal Capacitors	NFM Series	Noise Suppression	
	Feed Through Chip EMI Filters	NFE Series	Noise Suppression	
	Chip Common Mode Choke Coils	DLW/DLP Series	Noise Suppression	
	Microwave Absorbers	EA Series	Noise Suppression	
	Ferrite Cores	FS Series	Noise Suppression	
	Thin Type Sandwich Cores	FSSA Series	Noise Suppression	
Small Energy Devices	UMAC Series	Battery Backup		

Tablet Terminators

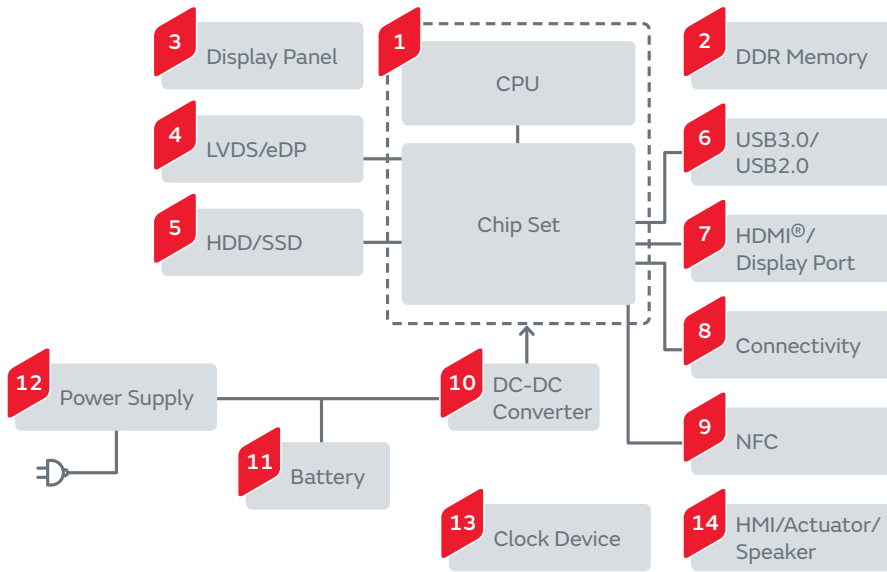

1 CPU/Chip Set

Micro DC-DC Converters LXDC Series	Low ESL Monolithic Ceramic Capacitors LLL/LLA/LLM Series
Polymer Aluminum Electrolytic Capacitors ECAS Series	Crystal Units XRC Series
Chip Ferrite Beads BLM Series	3 Terminal Capacitors NFM Series
	Thermistors NCP/PRF Series

2 DDR Memory

Micro DC-DC Converters LXDC Series
Polymer Aluminum Electrolytic Capacitors ECAS Series
Chip Ferrite Beads BLM Series

3 Display Panel

Metal Terminal Type Monolithic Ceramic Capacitors KRM Series	
Ceramic Resonators CERALOCK® CSTCE/CSTCR Series	
Power Inductors LQH Series	Thermistors PRF/PRG Series

4 LVDS/eDP

Chip Common Mode Choke Coils DLW/DLP Series	ESD Protection Devices LXES Series	Thermistors NCP/PRF Series

5 HDD/SSD

Shock Sensors PKGS Series	Micro DC-DC Converters LXDC Series	Polymer Aluminum Electrolytic Capacitors ECAS Series
Supercapacitors (EDLC) DMF/DMT Series	Actuators	Crystal Units XRC Series
		Thermistors NCP/PRF Series













6 USB3.0/USB2.0

Micro DC-DC Converters LXDC Series	Polymer Aluminum Electrolytic Capacitors ECAS Series	Crystal Units XRC Series
Chip Common Mode Choke Coils DLW/DLP Series	Chip Ferrite Beads BLM Series	ESD Protection Devices LXES Series
		Thermistors PRG Series

7 HDMI®/Display Port

Chip Common Mode Choke Coils DLW/DLP Series	ESD Protection Devices LXES Series	Thermistors PRG Series

8 Connectivity

Bluetooth® Modules 	Wi-Fi® Modules 	Bluetooth® - Wi-Fi® Combo Modules 	
SAW Filters SAF Series 	Chip Multilayer LC Filters LF Series 	Chip Multilayer Hybrid Baluns LDB/LDM Series 	
Chip Multilayer Diplexers LFD Series 	Chip Multilayer Hybrid Couplers LDC/LDJ Series 	Microwave Coaxial Cable Connectors 	
Microwave Coaxial Connectors with Switch 	Crystal Units XRC Series 	Micro DC-DC Converters LXDC Series 	ESD Protection Devices LXES Series 



9 NFC

NFC Antennas FLAN Series 	Micro DC-DC Converters LXDC Series 
Crystal Units XRC Series 	Chip Ferrite Beads BLM Series 
Variable Capacitors LXRW Series 	ESD Protection Devices LXES Series 
Chip Inductors (Chip Coils) LQM/LQH/LQB Series 	Trimmer Capacitors TZY2 Series 







10 DC-DC Converter

Micro DC-DC Converters LXDC Series 	Thermistors NCP/PRF Series 	Metal Terminal Type Monolithic Ceramic Capacitors KRM Series 	Polymer Aluminum Electrolytic Capacitors ECAS Series 	Monolithic Ceramic Capacitor on Interposer Board ZRB Series 
--	--	--	--	---



11 Battery

Ceramic Resonators CERALOCK® CSTCE/CSTCR Series 
Thermistors NXP/PRF/PRG Series 



12 Power Supply















Micro DC-DC Converters LXDC Series 	Monolithic Ceramic Capacitors for Medium Voltage GR/GA Series 	High Temperature Guaranteed Low Loss Lead Type Ceramic Capacitor DEA Series 	Safety Standard Certified Ceramic Capacitors Type KX/KY 
Ceramic Resonators CERALOCK® CSTCE/CSTCR Series 	Chip Common Mode Choke Coils DLW/DLP Series 	Thermistors NCP/NTP/PRF Series 	

13 Clock Device

Ceramic Resonators CERALOCK® CSTCE/CSTCR Series 	Crystal Units XRC Series 
---	--

14 HMI/Actuator/Speaker

Pyroelectric Infrared Sensors IRS Series 	Ultrasonic Sensors MA Series 	ESD Protection Devices LXES Series 
--	--	--

General Purpose	Monolithic Ceramic Capacitors	GRM Series	Coupling/Decoupling/For Step-up	
	Monolithic Ceramic Capacitors	GJM Series	High Frequency Filter Circuit	
	Resin External Electrode Monolithic Ceramic Capacitors	GRJ Series	Coupling/Decoupling/For Step-up	
	Polymer Aluminum Electrolytic Capacitors	ECAS Series	Smoothing/Transient Backup	
	Chip Inductors (Chip Coils)	LQW/LQP/LQG Series	High Frequency Circuit-Impedance Matching/Resonance	
	Chip Inductors (Chip Coils)	LQM/LQH/DFEC Series	Voltage Conversion	
	Chip Ferrite Beads	BLM Series	Noise Suppression	
	3 Terminal Capacitors	NFM Series	Noise Suppression	
	Feed Through Chip EMI Filters	NFE Series	Noise Suppression	
	Chip Common Mode Choke Coils	DLW/DLP Series	Noise Suppression	
	Microwave Absorbers	EA Series	Noise Suppression	
	Ferrite Cores	FS Series	Noise Suppression	
	Thin Type Sandwich Cores	FSSA Series	Noise Suppression	
Small Energy Devices	UMAC Series	Battery Backup		

Notebook Computers

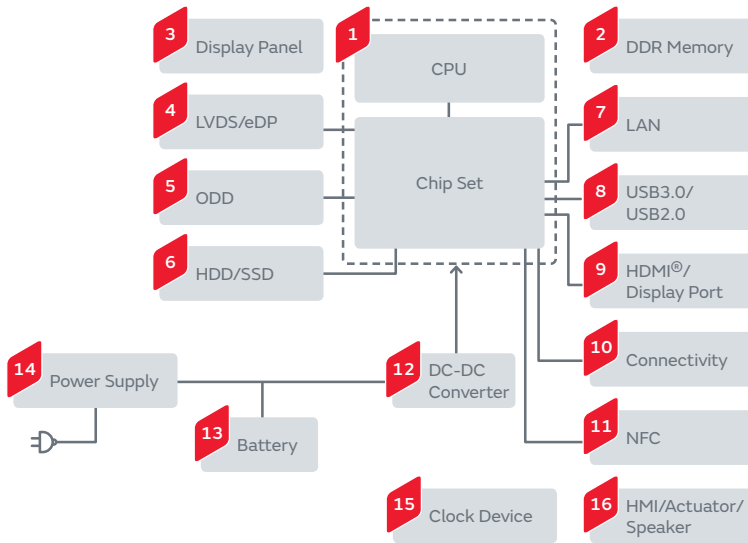

<p>1 CPU/Chip Set</p> <ul style="list-style-type: none"> Micro DC-DC Converters LXDC Series Low ESL Monolithic Ceramic Capacitors LLL/LLA/LLM Series Polymer Aluminum Electrolytic Capacitors ECAS Series Crystal Units XRC Series Chip Ferrite Beads BLM Series 3 Terminal Capacitors NFM Series Thermistors NCP/PRF Series 	<p>2 DDR Memory</p> <ul style="list-style-type: none"> Micro DC-DC Converters LXDC Series Polymer Aluminum Electrolytic Capacitors ECAS Series Chip Ferrite Beads BLM Series
<p>4 LVDS/eDP</p> <ul style="list-style-type: none"> Chip Common Mode Choke Coils DLW/DLP Series ESD Protection Devices LXES Series Thermistors NCP/PRF Series 	<p>3 Display Panel</p> <ul style="list-style-type: none"> Metal Terminal Type Monolithic Ceramic Capacitors KRM Series Ceramic Resonators CERALOCK® CSTCE/CSTCR Series Power Inductors LQH Series Thermistors PRF/PRG Series
<p>6 HDD/SSD</p> <ul style="list-style-type: none"> Shock Sensors PKGS Series Micro DC-DC Converters LXDC Series Polymer Aluminum Electrolytic Capacitors ECAS Series Supercapacitors (EDLC) DMF/DMT Series Actuators Crystal Units XRC Series Thermistors NCP/PRF Series 	<p>5 ODD</p> <ul style="list-style-type: none"> Ceramic Resonators CERALOCK® CSTCW Series Crystal Units XRC Series Thermistors NCP Series
<p>7 LAN</p> <ul style="list-style-type: none"> Monolithic Ceramic Capacitors for Medium Voltage GR4 Series Chip Common Mode Choke Coils DLW/DLP Series Crystal Units XRC Series 	<p>8 USB3.0/USB2.0</p> <ul style="list-style-type: none"> Micro DC-DC Converters LXDC Series Polymer Aluminum Electrolytic Capacitors ECAS Series Crystal Units XRC Series Chip Common Mode Choke Coils DLW/DLP Series Chip Ferrite Beads BLM Series ESD Protection Devices LXES Series Thermistors PRG Series

9 HDMI®/Display Port

Chip Common Mode Choke Coils
DLW/DLP Series



ESD Protection Devices
LXES Series



Thermistors
PRG Series



10 Connectivity

Bluetooth® Modules



Wi-Fi® Modules



Bluetooth® - Wi-Fi®
Combo Modules



Chip Multilayer Hybrid Baluns
LDB/LDM Series



SAW Filters
SAF Series



Chip Multilayer LC Filters
LF Series



Chip Multilayer Diplexers
LFD Series



Chip Multilayer Hybrid Couplers
LDC/LDJ Series



Crystal Units
XRC Series



Microwave Coaxial
Cable Connectors



Microwave Coaxial Connectors
with Switch



Micro DC-DC Converters
LXDC Series



ESD Protection Devices
LXES Series



11 NFC

NFC Antennas
FLAN Series



Micro
DC-DC Converters
LXDC Series



Crystal Units
XRC Series



Chip Ferrite Beads
BLM Series



Chip Inductors
(Chip Coils)
LQM/LQH/LQB Series



Trimmer
Capacitors
TZY2 Series



Variable Capacitors
LXRW Series



ESD
Protection Devices
LXES Series



12 DC-DC Converter

Micro
DC-DC Converters
LXDC Series



Thermistors
NCP/PRF Series



Metal Terminal Type
Monolithic
Ceramic Capacitors
KRM Series



Polymer Aluminum
Electrolytic Capacitors
ECAS Series



Monolithic Ceramic Capacitor on Interposer Board
ZRB Series



13 Battery

Ceramic Resonators
CERALOCK®
CSTCE/CSTCR Series



Thermistors
NXR/PRF/PRG Series



14 Power Supply

Micro
DC-DC Converters
LXDC Series



Monolithic
Ceramic Capacitors
for Medium Voltage
GR/GA Series



High Temperature
Guaranteed Low
Loss Lead Type
Ceramic Capacitor
DEA Series



Safety Standard Certified
Ceramic Capacitors
Type KX/KY



Ceramic Resonators
CERALOCK®
CSTCE/CSTCR Series



Chip Common Mode
Choke Coils
DLW/DLP Series



Thermistors
NCP/NTP/PRF Series



15 Clock Device

Ceramic Resonators CERALOCK®
CSTCE/CSTCR Series



Crystal Units
XRC Series



16 HMI/Actuator/Speaker

Pyroelectric
Infrared Sensors
IRS Series



Ultrasonic Sensors
MA Series



ESD
Protection Devices
LXES Series



General Purpose

Monolithic Ceramic Capacitors

GRM Series

Coupling/Decoupling/For Step-up



Monolithic Ceramic Capacitors

GJM Series

High Frequency Filter Circuit



Resin External Electrode Monolithic Ceramic Capacitors

GRJ Series

Coupling/Decoupling/For Step-up



Polymer Aluminum Electrolytic Capacitors

ECAS Series

Smoothing/Transient Backup



Chip Inductors (Chip Coils)

LQW/LQP/LQG Series

High Frequency Circuit-Impedance Matching/Resonance



Chip Inductors (Chip Coils)

LQM/LQH/DFEC Series

Voltage Conversion



Chip Ferrite Beads

BLM Series

Noise Suppression



3 Terminal Capacitors

NFM Series

Noise Suppression



Feed Through Chip EMI Filters

NFE Series

Noise Suppression



Chip Common Mode Choke Coils

DLW/DLP Series

Noise Suppression



Microwave Absorbers

EA Series

Noise Suppression



Ferrite Cores

FS Series

Noise Suppression



Thin Type Sandwich Cores

FSSA Series

Noise Suppression



Small Energy Devices

UMAC Series

Battery Backup



MFP (Multi Function Printer/Product/Peripheral)

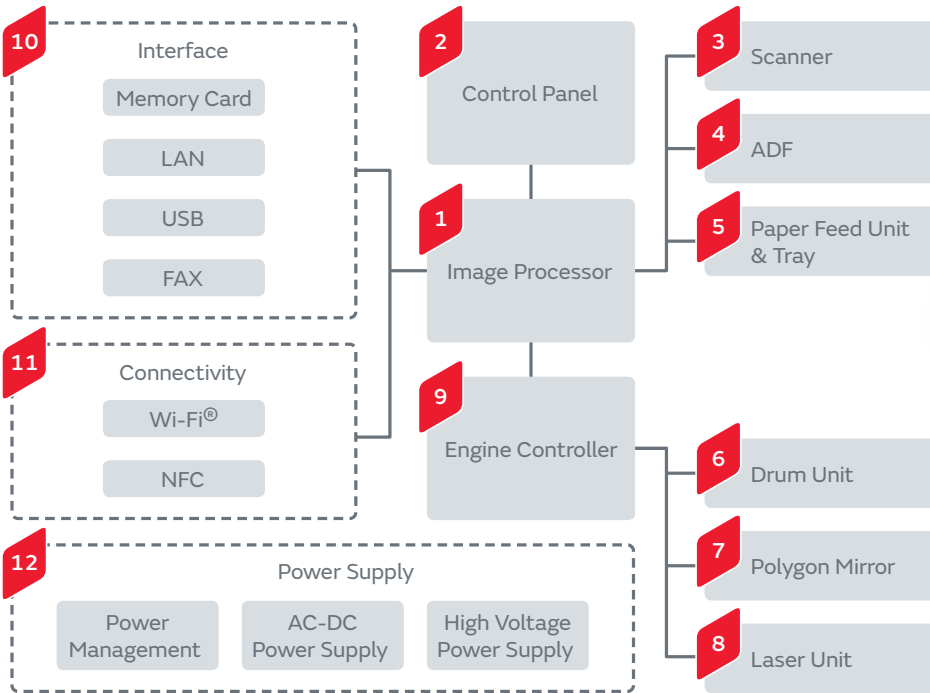

1 Image Processor

<p>Isolated DC-DC Converters MYB Series</p>	<p>Non-isolated DC-DC Converters OKL/MPDR/MPDT Series</p>	<p>Micro DC-DC Converters LXDC Series</p>	<p>Polymer Aluminum Electrolytic Capacitors ECAS Series</p>
<p>Low ESL Monolithic Ceramic Capacitors LLL/LLA/LLM Series</p>	<p>Magnetic Sensors (AMR Sensors) MR Series</p>	<p>Crystal Units XRC Series</p>	<p>Thermistors NCP/PRF Series</p>

3 Scanner

Ultrasonic Sensors
MA Series

4 ADF

Ultrasonic Sensors
MA Series

Accelerometers
SCA Series

Rotary Position Sensors
SV Series

2 Control Panel

<p>Rotary Position Sensors SV Series</p>	<p>Micro DC-DC Converters LXDC Series</p>	<p>Metal Terminal Type Monolithic Ceramic Capacitors KRM Series</p>	<p>Thermistors NCP/PRF Series</p>
<p>Polymer Aluminum Electrolytic Capacitors ECAS Series</p>	<p>Piezoelectric Sounders PKMCS/PKLCs/PKM Series</p>	<p>Chip Common Mode Choke Coils DLW/DLP Series</p>	

5 Paper Feed Unit & Tray

Magnetic Sensors (AMR Sensors)
MR Series

Rotary Position Sensors
SV Series

6 Drum Unit

Thermistors
NCP/PRF Series

7 Polygon Mirror

Accelerometers
SCA Series

8 Laser Unit

Thermistors
NCP/PRF Series

9 Engine Controller

Monolithic Ceramic Capacitors for Medium Voltage GR/GA Series 

High Temperature Guaranteed Low Loss Lead Type Ceramic Capacitor DEA Series 

Shock Sensors PKGS Series 

Ceramic Resonators CERALOCK® CSTCE/CSTCR Series 

Crystal Units XRC Series 

Thermistors PRF/PTG Series 

10 Interface

Polymer Aluminum Electrolytic Capacitors ECAS Series 

Crystal Units XRC Series 

Chip Common Mode Choke Coils DLW/DLP Series 

ESD Protection Devices LXES Series 

Thermistors PRF Series 

11 Connectivity

Wi-Fi® Modules 

NFC Antennas FLAN Series 

Micro DC-DC Converters LXDC Series 

Ceramic Resonators CERALOCK® CSTCE/CSTCR Series 

Crystal Units XRC Series 

Chip Inductors (Chip Coils) LQB Series 

ESD Protection Devices LXES Series 

12 Power Supply

Micro DC-DC Converters LXDC Series 

Monolithic Ceramic Capacitors for Medium Voltage GR/GA Series 

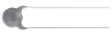













High Temperature Guaranteed Low Loss Lead Type Ceramic Capacitor DEA Series 

Safety Standard Certified Ceramic Capacitors Type KX/KY 

AC Line Filters PLA/PLH/PLY Series 

High Voltage Resistors MHR Series 

Large Current Common Mode Choke Coils PLT10HH Series 

General Purpose	Monolithic Ceramic Capacitors	GRM Series	Coupling/Decoupling/For Step-up	
	Monolithic Ceramic Capacitors	GJM Series	High Frequency Filter Circuit	
	Resin External Electrode Monolithic Ceramic Capacitors	GRJ Series	Coupling/Decoupling/For Step-up	
	Polymer Aluminum Electrolytic Capacitors	ECAS Series	Smoothing/Transient Backup	
	Chip Inductors (Chip Coils)	LQW/LQP/LQG Series	High Frequency Circuit-Impedance Matching/Resonance	
	Chip Inductors (Chip Coils)	LQM/LQH/DFEC Series	Voltage Conversion	
	Chip Ferrite Beads	BLM Series	Noise Suppression	
	3 Terminal Capacitors	NFM Series	Noise Suppression	
	Feed Through Chip EMI Filters	NFE Series	Noise Suppression	
	Chip Common Mode Choke Coils	DLW/DLP Series	Noise Suppression	
	Microwave Absorbers	EA Series	Noise Suppression	
	Ferrite Cores	FS Series	Noise Suppression	
	Thin Type Sandwich Cores	FSSA Series	Noise Suppression	
Small Energy Devices	UMAC Series	Battery Backup		

Televisions

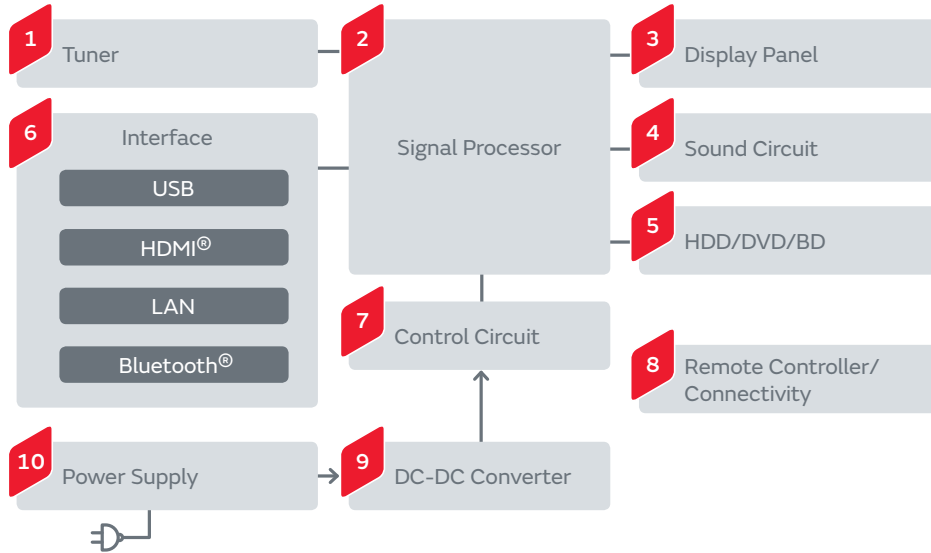

1 Tuner

Crystal Units
XRC Series



Chip Inductors (Chip Coils)
LQW Series



ESD Protection Devices
LXES Series



2 Signal Processor

Polymer Aluminum
Electrolytic Capacitors
ECAS Series



Ceramic Resonators
CERALOCK®
CSTCE/CSTCR Series



Crystal Units
XRC Series



3 Terminal Capacitors
NFM Series



NFC Antennas
FLAN Series



Thermistors
NCP/PRF Series



3 Display Panel

DC-DC Converters
OKL Series



Metal Terminal Type
Monolithic Ceramic Capacitors
KRM Series



Monolithic Ceramic Capacitor
on Interposer Board
ZRB Series



Polymer Aluminum Electrolytic Capacitors
ECAS Series



Chip Common Mode Choke Coils
DLW/DLP Series



Power Inductors
LQH Series



Rotary Position Sensors
SV Series



Thermistors
NCP/PRF Series



4 Sound Circuit

Chip Common Mode Choke Coils
DLW/DLP Series



5 HDD/DVD/BD

Shock Sensors
PKGS Series



Polymer Aluminum Electrolytic Capacitors
ECAS Series



Ceramic Resonators CERALOCK®
CSTCE Series



Crystal Units
XRC Series



Thermistors
NCP/PRF Series



6 Interface

Bluetooth® Modules



Bluetooth® Smart Modules



Polymer Aluminum Electrolytic Capacitors
ECAS Series



Ceramic Resonators CERALOCK®
CSTCE/CSTCR Series



Crystal Units
XRC Series



Chip Common Mode Choke Coils
DLW/DLP Series



ESD Protection Devices
LXES Series



Thermistors
PRG Series



7 Control Circuit

Bluetooth® Modules



Pyroelectric Infrared Sensors
IRS Series



Micro DC-DC Converters
LXDC Series



Ceramic Resonators CERALOCK®
CSTCE/CSTCR Series



8 Remote Controller/Connectivity

Bluetooth® Modules



Wi-Fi® Modules



Bluetooth® Smart Modules



Shock Sensors
PKGS Series



Micro DC-DC Converters
LXDC Series



Ceramic Resonators CERALOCK®
CSTCE/CSTCR Series



Piezoelectric Sounders
PKMCS/PKLCS/PKM Series



ESD Protection Devices
LXES Series



Chip Inductors (Chip Coils)
LQB Series



9 DC-DC Converter

Micro DC-DC Converters
LXDC Series



Metal Terminal Type Monolithic Ceramic Capacitors
KRM Series



Polymer Aluminum
Electrolytic Capacitors
ECAS Series



Power Inductors
LQH Series



Thermistors
NCP/PRF Series



10 Power Supply

Monolithic Ceramic Capacitors
for Medium Voltage
GR/GA Series



High Temperature Guaranteed
Low Loss Lead Type
Ceramic Capacitor
DEA Series



Safety Standard Certified
Ceramic Capacitors
Type KX/KY



AC Line Filters
PLA/PLY Series



Thermistors
NCP/NTP/PRF/PTG Series



General Purpose

Monolithic Ceramic Capacitors

GRM Series

Coupling/Decoupling/For Step-up



Monolithic Ceramic Capacitors

GJM Series

High Frequency Filter Circuit



Resin External Electrode Monolithic Ceramic Capacitors

GRJ Series

Coupling/Decoupling/For Step-up



Polymer Aluminum Electrolytic Capacitors

ECAS Series

Smoothing/Transient Backup



Chip Inductors (Chip Coils)

LQW/LQP/LQG Series

High Frequency Circuit-Impedance Matching/Resonance



Chip Inductors (Chip Coils)

LQM/LQH/DFEC Series

Voltage Conversion



Chip Ferrite Beads

BLM Series

Noise Suppression



3 Terminal Capacitors

NFM Series

Noise Suppression



Feed Through Chip EMI Filters

NFE Series

Noise Suppression



Chip Common Mode Choke Coils

DLW/DLP Series

Noise Suppression



Microwave Absorbers

EA Series

Noise Suppression



Ferrite Cores

FS Series

Noise Suppression



Thin Type Sandwich Cores

FSSA Series

Noise Suppression



Set-top Box

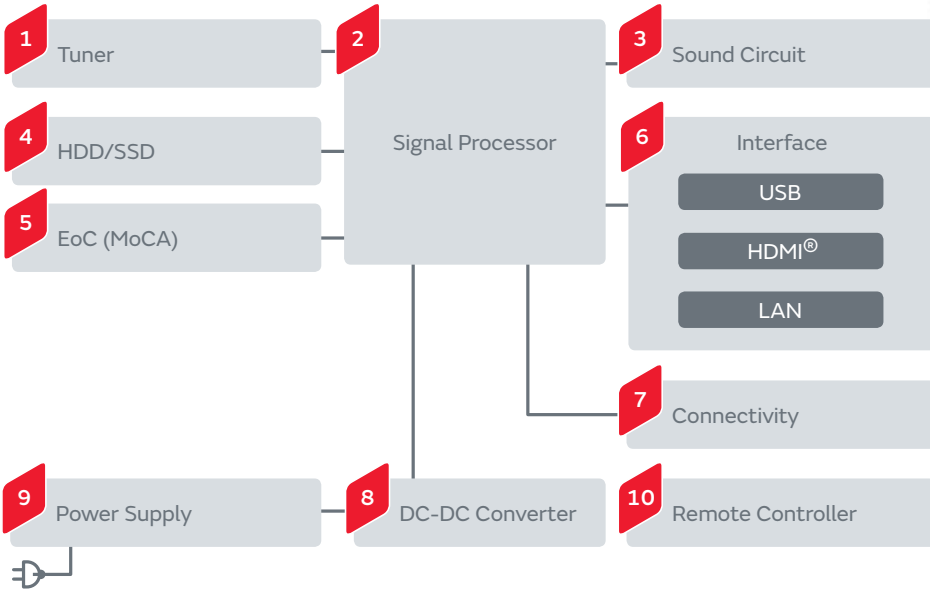

1 Tuner

- Crystal Units XRC Series
- Chip Inductors (Chip Coils) LQW Series
- ESD Protection Devices LXES Series

2 Signal Processor

- Polymer Aluminum Electrolytic Capacitors ECAS Series
- Ceramic Resonators CERALOCK® CSTCE/CSTCR Series
- Crystal Units XRC Series
- 3 Terminal Capacitors NFM Series

3 Sound Circuit

- Chip Common Mode Choke Coils DLW/DLP Series

4 HDD/SSD

- Shock Sensors PKGS Series
- Polymer Aluminum Electrolytic Capacitors ECAS Series
- Ceramic Resonators CERALOCK® CSTCE Series
- Crystal Units XRC Series
- Supercapacitors (EDLC) DMF/DMT Series
- Thermistors NCP/PRF Series

5 EoC (MoCA)

- Chip Multilayer LC Filters LF Series
- Chip Multilayer Hybrid Baluns LDB/LDM Series
- Ceramic Resonators CERALOCK® CSTCE/CSTCR Series

6 Interface

- Polymer Aluminum Electrolytic Capacitors ECAS Series
- Ceramic Resonators CERALOCK® CSTCE/CSTCR Series
- Crystal Units XRC Series
- Chip Common Mode Choke Coils DLW/DLP Series
- ESD Protection Devices LXES Series
- Thermistors PRG Series

7 Connectivity

Wi-Fi® Modules

Microwave Coaxial Cable Connectors

Microwave Coaxial Connectors with Switch

Micro DC-DC Converters LXDC Series

Ceramic Resonators CERALOCK® CSTCE/CSTCR Series

Crystal Units XRC Series

ESD Protection Devices LXES Series

8 DC-DC Converter

DC-DC Converters OKL Series

Micro DC-DC Converters LXDC Series

Metal Terminal Type Monolithic Ceramic Capacitors KRM Series

Monolithic Ceramic Capacitor on Interposer Board ZRB Series

Polymer Aluminum Electrolytic Capacitors ECAS Series

Power Inductors LQH/DFEC Series

Thermistors NCP/PRF Series

9 Power Supply

Monolithic Ceramic Capacitors for Medium Voltage GR/GA Series

High Temperature Guaranteed Low Loss Lead Type Ceramic Capacitor DEA Series

Safety Standard Certified Ceramic Capacitors Type KX/KY

AC Line Filters PLA/PLY Series

Thermistors NCP/NTP/PRF/PTG Series

10 Remote Controller

Micro DC-DC Converters LXDC Series

Ceramic Resonators CERALOCK® CSTCE/CSTCR Series

Piezoelectric Sounders PKMCS/PKLCs/PKM Series

Trimmer Capacitors TZY2 Series

General Purpose	Monolithic Ceramic Capacitors	GRM Series	Coupling/Decoupling/For Step-up	
	Monolithic Ceramic Capacitors	GJM Series	High Frequency Filter Circuit	
	Resin External Electrode Monolithic Ceramic Capacitors	GRJ Series	Coupling/Decoupling/For Step-up	
	Polymer Aluminum Electrolytic Capacitors	ECAS Series	Smoothing/Transient Backup	
	Chip Inductors (Chip Coils)	LQW/LQP/LQG Series	High Frequency Circuit-Impedance Matching/Resonance	
	Chip Inductors (Chip Coils)	LQM/LQH/DFEC Series	Voltage Conversion	
	Chip Ferrite Beads	BLM Series	Noise Suppression	
	3 Terminal Capacitors	NFM Series	Noise Suppression	
	Feed Through Chip EMI Filters	NFE Series	Noise Suppression	
	Chip Common Mode Choke Coils	DLW/DLP Series	Noise Suppression	
	Microwave Absorbers	EA Series	Noise Suppression	
	Ferrite Cores	FS Series	Noise Suppression	
	Thin Type Sandwich Cores	FSSA Series	Noise Suppression	
Small Energy Devices	UMAC Series	Battery Backup		

HEMS

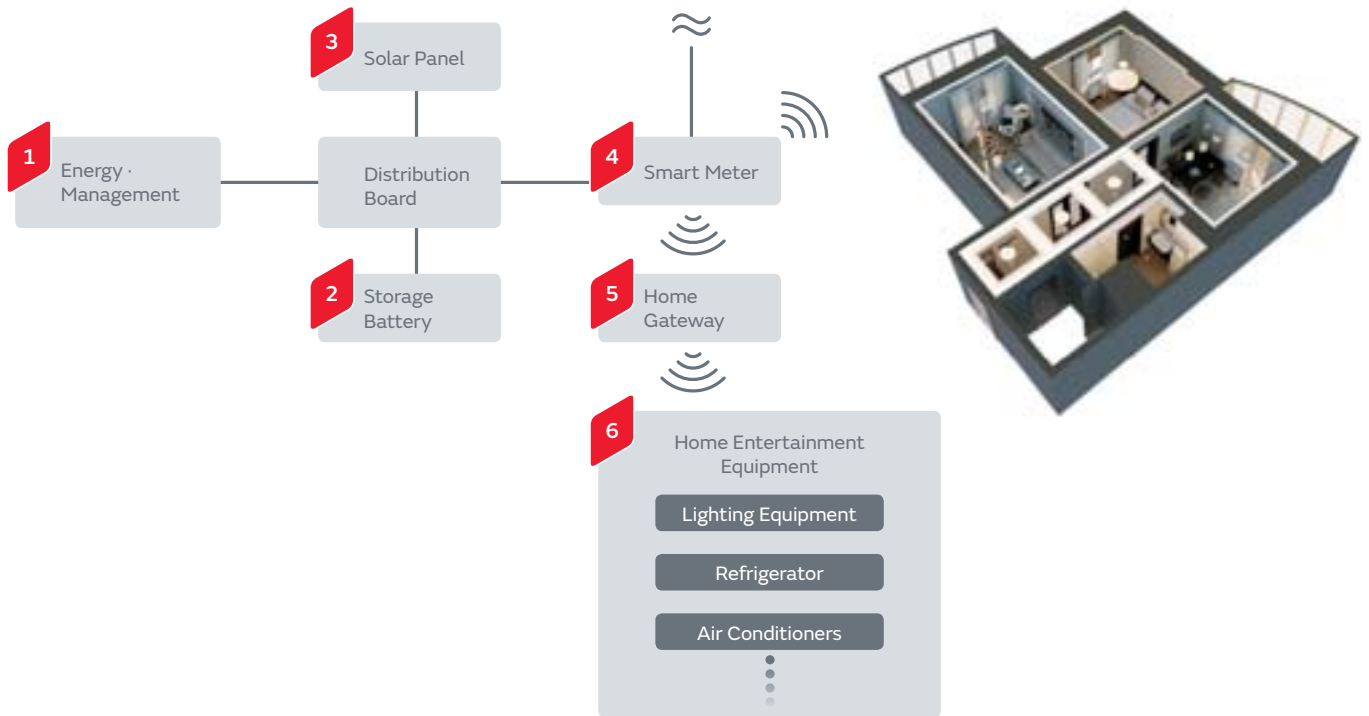

1 Energy · Management

Ceramic Resonators CERALOCK®
CSTCE/CSTCR Series



Crystal Units
XRC Series



Topics



Introduction of Examples as Energy System

<http://www.murata.com/en-global/about/newsroom/news/product/power/2013/0426>

2 Storage Battery

Isolated DC-DC Converters
MYB Series



Non-isolated DC-DC Converters
OKL/MPDR/MPDT Series

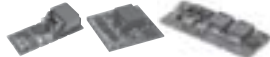

Monolithic Ceramic Capacitors
for Medium Voltage
GR/GA Series



High Temperature
Guaranteed Low Loss Lead Type
Ceramic Capacitor
DEA Series



Safety Standard Certified
Ceramic Capacitors
Type KX/KY



Thermistors
NCP/NTP/PRF/PRG/PTG Series



Micro DC-DC Converters
LXDC Series



Small Energy Devices
UMAC Series



3 Solar Panel

Isolated
DC-DC Converters
MYB Series



Non-isolated
DC-DC Converters
OKL/MPD Series



Monolithic Ceramic Capacitors
for Medium Voltage
GR/GA Series



Micro
DC-DC Converters
LXDC Series





Supercapacitors (EDLC)
DMF/DMT Series





4 Smart Meter

Chip Multilayer LC Filters LF Series 

Chip Multilayer Hybrid Baluns LDB/LDM Series 

Wi-Fi® Modules 

Sub-GHz Modules 

Isolated DC-DC Converters MYB Series 

Non-isolated DC-DC Converters OKL/MPD Series 

Supercapacitors (EDLC) DMF/DMT Series 

Monolithic Ceramic Capacitors for Ethernet LAN and Primary - Secondary Couplings of DC-DC Converters GR4 Series 

High Temperature Guaranteed Low Loss Lead Type Ceramic Capacitor DEA Series 

Safety Standard Certified Ceramic Capacitors Type KX/KY 

Crystal Units XRC Series 

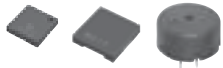
Piezoelectric Sounders PKMCS/PKLCs/PKM Series 

5 Home Gateway

Bluetooth® Modules 

Wi-Fi® Modules 

Sub-GHz Modules 

6 Home Entertainment Equipment

Bluetooth® Modules 

Wi-Fi® Modules 

Sub-GHz Modules 

Ultrasonic Sensors MA Series 







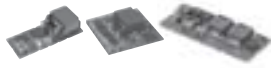







Shock Sensors PKGS Series 

Magnetic Sensors (AMR Sensors) MR Series 

Isolated DC-DC Converters MYB Series 

Non-isolated DC-DC Converters OKL/MPDR/MPDT Series 

Crystal Units XRC Series 

General Purpose	Monolithic Ceramic Capacitors	GRM Series	Coupling/Decoupling/For Step-up	
	Monolithic Ceramic Capacitors	GJM Series	High Frequency Filter Circuit	
	Resin External Electrode Monolithic Ceramic Capacitors	GRJ Series	Coupling/Decoupling/For Step-up	
	Polymer Aluminum Electrolytic Capacitors	ECAS Series	Smoothing/Transient Backup	
	Chip Inductors (Chip Coils)	LQW/LQP/LQG Series	High Frequency Circuit-Impedance Matching/Resonance	
	Chip Inductors (Chip Coils)	LQM/LQH/DFEC Series	Voltage Conversion	
	Chip Ferrite Beads	BLM Series	Noise Suppression	
	3 Terminal Capacitors	NFM Series	Noise Suppression	
	Feed Through Chip EMI Filters	NFE Series	Noise Suppression	
	Chip Common Mode Choke Coils	DLW/DLP Series	Noise Suppression	
	Microwave Absorbers	EA Series	Noise Suppression	
	Ferrite Cores	FS Series	Noise Suppression	
	Thin Type Sandwich Cores	FSSA Series	Noise Suppression	
	Small Energy Devices	UMAC Series	Battery Backup	

Smartmeter

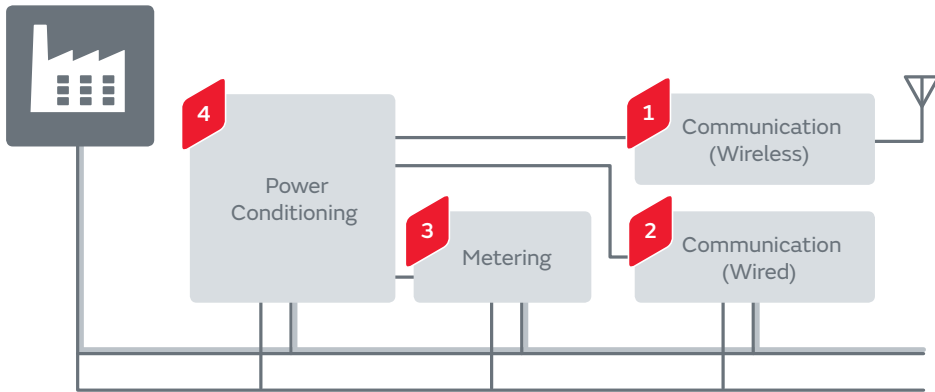

1 Communication (Wireless)

<p>Wi-Fi® Modules</p>	<p>Sub-GHz Modules</p>	<p>Chip Multilayer LC Filters LF Series</p>
<p>Chip Multilayer Hybrid Baluns LDB/LDM Series</p>	<p>Microwave Coaxial Cable Connectors</p>	<p>Microwave Coaxial Connectors with Switch</p>
<p>Crystal Units XRC Series</p>	<p>ESD Protection Devices LXES Series</p>	<p>Thermistors NCP/PRF/PRG Series</p>

2 Communication (Wired)

<p>Chip Inductors (Chip Coils) LQW/LQP/LQG Series</p>	<p>Monolithic Ceramic Capacitors for Medium Voltage GR/GA Series</p>
<p>High Temperature Guaranteed Low Loss Lead Type Ceramic Capacitor DEA Series</p>	<p>Safety Standard Certified Ceramic Capacitors Type KX/KY</p>
<p>Radial Lead Type Monolithic Ceramic Capacitors RDE Series</p>	<p>Thermistors NCP/PRF/PRG Series</p>
<p>Ceramic Resonators CERALOCK® CSTCE/CSTCR Series</p>	<p>Crystal Units/ Crystal Oscillators</p>
<p>ESD Protection Devices LXES Series</p>	



















3 Metering

<p>Chip Common Mode Choke Coils DLW/DLP Series</p>	<p>Thermistors NCP/PRF/PRG Series</p>	<p>Ceramic Resonators CERALOCK® CSTCE/CSTCR Series</p>
<p>Crystal Units XRC Series</p>	<p>Piezoelectric Sounders PKMCS/PK LCS Series</p>	

4 Power Conditioning

<p>Non-isolated DC-DC Converters OKL/MPD Series</p>	<p>Monolithic Ceramic Capacitors for Medium Voltage GR/GA Series</p>	<p>High Temperature Guaranteed Low Loss Lead Type Ceramic Capacitor DEA Series</p>	<p>Safety Standard Certified Ceramic Capacitors Type KX/KY</p>	<p>Radial Lead Type Monolithic Ceramic Capacitors RDE Series</p>
<p>Chip Inductors (Chip Coils) LQH Series</p>	<p>AC Line Filters PLA Series</p>	<p>Thermistors NCP/PRF/PRG Series</p>	<p>Polymer Aluminum Electrolytic Capacitors ECAS Series</p>	<p>Supercapacitors (EDLC) DMF/DMT Series</p>
<p>Micro DC-DC Converters LXDC Series</p>				

General Purpose

Monolithic Ceramic Capacitors	GRM Series	Coupling/Decoupling/For Step-up	
Monolithic Ceramic Capacitors	GJM Series	High Frequency Filter Circuit	
Resin External Electrode Monolithic Ceramic Capacitors	GRJ Series	Coupling/Decoupling/For Step-up	
Polymer Aluminum Electrolytic Capacitors	ECAS Series	Smoothing/Transient Backup	
Chip Inductors (Chip Coils)	LQW/LQP/LQG Series	High Frequency Circuit-Impedance Matching/Resonance	  
Chip Inductors (Chip Coils)	LQM/LQH/DFEC Series	Voltage Conversion	  
Chip Ferrite Beads	BLM Series	Noise Suppression	
3 Terminal Capacitors	NFM Series	Noise Suppression	
Feed Through Chip EMI Filters	NFE Series	Noise Suppression	
Chip Common Mode Choke Coils	DLW/DLP Series	Noise Suppression	 
Microwave Absorbers	EA Series	Noise Suppression	
Ferrite Cores	FS Series	Noise Suppression	
Thin Type Sandwich Cores	FSSA Series	Noise Suppression	

Thermostat

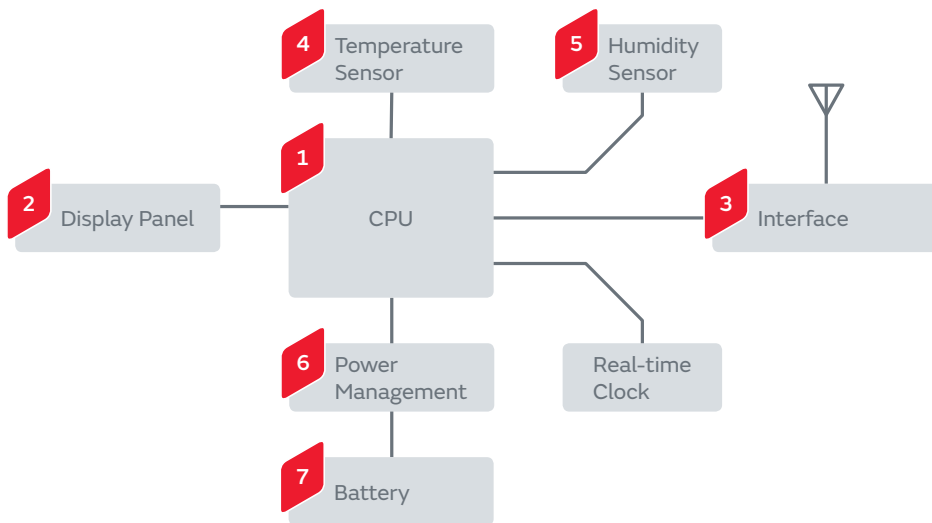

1 CPU

<p>Low ESL Monolithic Ceramic Capacitors LLL/LLA/LLM Series</p>	<p>Polymer Aluminum Electrolytic Capacitors ECAS Series</p>	
<p>Ceramic Resonators CERALOCK® CSTCE/CSTCR Series</p>	<p>Crystal Units XRC Series</p>	<p>Thermistors NCP/PRF Series</p>

2 Display Panel

<p>Metal Terminal Type Monolithic Ceramic Capacitors KRM Series</p>	<p>Polymer Aluminum Electrolytic Capacitors ECAS Series</p>
<p>Thermistors NCP/PRF Series</p>	<p>Piezoelectric Sounders PKMCS/PKLCS Series</p>

3 Interface

<p>Wi-Fi® Modules</p>	<p>Micro DC-DC Converters LXDC Series</p>	<p>Ceramic Resonators CERALOCK® CSTCE/CSTCR Series</p>
<p>Crystal Units XRC Series</p>	<p>Chip Inductors (Chip Coils) LQM/LQH/LQB Series</p>	<p>ESD Protection Devices LXES Series</p>

4 Temperature Sensor

<p>Thermistors NCP/NTP/PRF/PRG/PTG Series</p>	
<p>Ceramic Resonators CERALOCK® CSTCE/CSTCR Series</p>	<p>Crystal Units XRC Series</p>

5 Humidity Sensor

<p>Thermistors NCP/NTP/PRF/PRG/PTG Series</p>	<p>Ceramic Resonators CERALOCK® CSTCE/CSTCR Series</p>	<p>Crystal Units XRC Series</p>
---	--	-------------------------------------

6 Power Management

Micro DC-DC Converters LXDC Series

Monolithic Ceramic Capacitors for Medium Voltage GR/GA Series

High Temperature Guaranteed Low Loss Lead Type Ceramic Capacitor DEA Series

Safety Standard Certified Ceramic Capacitors Type KX/KY

Ceramic Resonators CERALOCK® CSTCE/CSTCR Series

Piezoelectric Sounders PKMCS/PKLCs/PKM Series

Thermistors NCP/PRF/PRG Series

7 Battery

Thermistors NCP/PRF/PRG Series

Micro DC-DC Converters LXDC Series

Supercapacitors (EDLC) DMF/DMT Series

Small Energy Devices UMAC Series

General Purpose	Monolithic Ceramic Capacitors	GRM Series	Coupling/Decoupling/For Step-up	
	Monolithic Ceramic Capacitors	GJM Series	High Frequency Filter Circuit	
	Resin External Electrode Monolithic Ceramic Capacitors	GRJ Series	Coupling/Decoupling/For Step-up	
	Polymer Aluminum Electrolytic Capacitors	ECAS Series	Smoothing/Transient Backup	
	Chip Inductors (Chip Coils)	LQW/LQP/LQG Series	High Frequency Circuit-Impedance Matching/Resonance	
	Chip Inductors (Chip Coils)	LQM/LQH/DFEC Series	Voltage Conversion	
	Chip Ferrite Beads	BLM Series	Noise Suppression	
	3 Terminal Capacitors	NFM Series	Noise Suppression	
	Feed Through Chip EMI Filters	NFE Series	Noise Suppression	
	Chip Common Mode Choke Coils	DLW/DLP Series	Noise Suppression	
	Microwave Absorbers	EA Series	Noise Suppression	
	Ferrite Cores	FS Series	Noise Suppression	
	Thin Type Sandwich Cores	FSSA Series	Noise Suppression	

Human Detection



1 Microcontroller

- Low ESL Monolithic Ceramic Capacitors LLL/LLA/LLM Series
- Polymer Aluminum Electrolytic Capacitors ECAS Series
- Crystal Units XRC Series
- Thermistors NCP/PRF Series

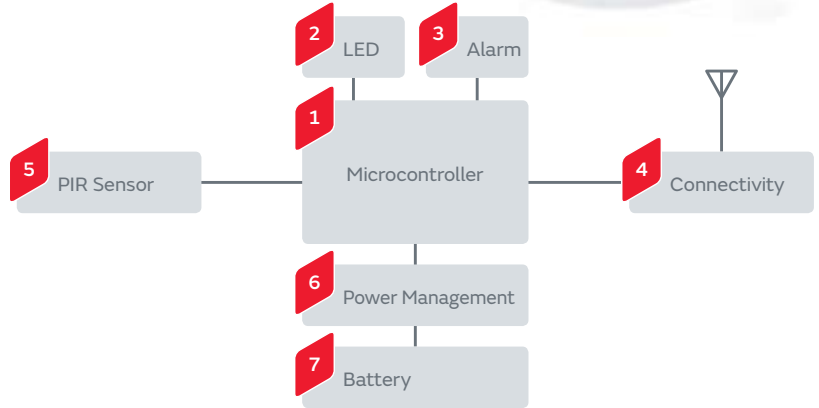

2 LED

- Supercapacitors (EDLC) DMF/DMT Series
- Monolithic Ceramic Capacitors for Medium Voltage GR/GA Series
- High Temperature Guaranteed Low Loss Lead Type Ceramic Capacitor DEA Series
- Safety Standard Certified Ceramic Capacitors Type KX/KY
- Thermistors NCP/NTP/PRF/PRG/PTG Series
- AC Line Filters PLA/PLH/PLY Series

3 Alarm

- Piezoelectric Sounders PKMCS/PKLCs/PKM Series

4 Connectivity

- Wi-Fi® Modules
- Micro DC-DC Converters LXDC Series
- Ceramic Resonators CERALOCK® CSTCE/CSTCR Series
- Crystal Units XRC Series
- Chip Inductors (Chip Coils) LQM/LQH/LQB Series
- ESD Protection Devices LXES Series

5 PIR Sensor

- Pyroelectric Infrared Sensors IRA Series

6 Power Management

- Micro DC-DC Converters LXDC Series
- Monolithic Ceramic Capacitors for Medium Voltage GR/GA Series
- High Temperature Guaranteed Low Loss Lead Type Ceramic Capacitor DEA Series
- Safety Standard Certified Ceramic Capacitors Type KX/KY
- Ceramic Resonators CERALOCK® CSTCE/CSTCR Series
- Chip Common Mode Choke Coils DLW/DLP Series
- Thermistors NCP/PRF/PRG Series

7 Battery

- Small Energy Devices UMAC Series
- Micro DC-DC Converters LXDC Series
- Thermistors NCP/PRF/PRG Series

General Purpose	Series	Application	Image
Monolithic Ceramic Capacitors	GRM Series	Coupling/Decoupling/For Step-up	
Monolithic Ceramic Capacitors	GJM Series	High Frequency Filter Circuit	
Resin External Electrode Monolithic Ceramic Capacitors	GRJ Series	Coupling/Decoupling/For Step-up	
Polymer Aluminum Electrolytic Capacitors	ECAS Series	Smoothing/Transient Backup	
Chip Inductors (Chip Coils)	LQW/LQP/LQG Series	High Frequency Circuit-Impedance Matching/Resonance	
Chip Inductors (Chip Coils)	LQM/LQH/DFEC Series	Voltage Conversion	
Chip Ferrite Beads	BLM Series	Noise Suppression	
3 Terminal Capacitors	NFM Series	Noise Suppression	
Feed Through Chip EMI Filters	NFE Series	Noise Suppression	
Chip Common Mode Choke Coils	DLW/DLP Series	Noise Suppression	
Microwave Absorbers	EA Series	Noise Suppression	
Ferrite Cores	FS Series	Noise Suppression	
Thin Type Sandwich Cores	FSSA Series	Noise Suppression	

Air Dispenser

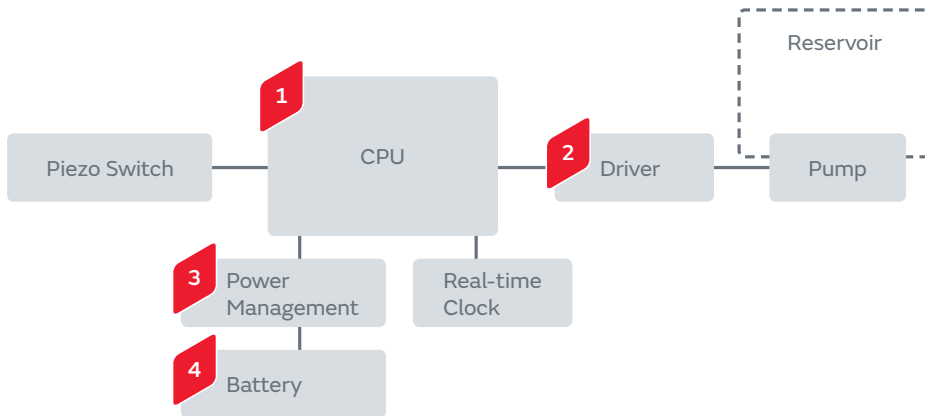

1 CPU

Low ESL Monolithic Ceramic Capacitors
LLL/LLA/LLM Series



Polymer Aluminum Electrolytic Capacitors
ECAS Series



Ceramic Resonators CERALOCK®
CSTCE/CSTCR Series



Crystal Units
XRC Series



Thermistors
NCP/PRF Series



2 Driver

Thermistors
NCP/NXRT/NTP/PRF Series



3 Power Management

Micro DC-DC Converters
LXDC Series



Monolithic Ceramic Capacitors for Medium Voltage
GR/GA Series



High Temperature Guaranteed Low Loss Lead Type Ceramic Capacitor
DEA Series



Safety Standard Certified Ceramic Capacitors
Type KX/KY



Ceramic Resonators CERALOCK®
CSTCE/CSTCR Series



Thermistors
NCP/NTP/PRF Series



4 Battery

Supercapacitors (EDLC)
DMF/DMT Series



Thermistors
NXR/PRF/PRG Series



Small Energy Devices
UMAC Series



General Purpose

Monolithic Ceramic Capacitors	GRM Series	Coupling/Decoupling/For Step-up	
Monolithic Ceramic Capacitors	GJM Series	High Frequency Filter Circuit	
Resin External Electrode Monolithic Ceramic Capacitors	GRJ Series	Coupling/Decoupling/For Step-up	
Polymer Aluminum Electrolytic Capacitors	ECAS Series	Smoothing/Transient Backup	
Chip Inductors (Chip Coils)	LQW/LQP/LQG Series	High Frequency Circuit-Impedance Matching/Resonance	
Chip Inductors (Chip Coils)	LQM/LQH/DFEC Series	Voltage Conversion	
Chip Ferrite Beads	BLM Series	Noise Suppression	
3 Terminal Capacitors	NFM Series	Noise Suppression	
Feed Through Chip EMI Filters	NFE Series	Noise Suppression	
Chip Common Mode Choke Coils	DLW/DLP Series	Noise Suppression	
Microwave Absorbers	EA Series	Noise Suppression	
Ferrite Cores	FS Series	Noise Suppression	
Thin Type Sandwich Cores	FSSA Series	Noise Suppression	

Blood Pressure Monitor

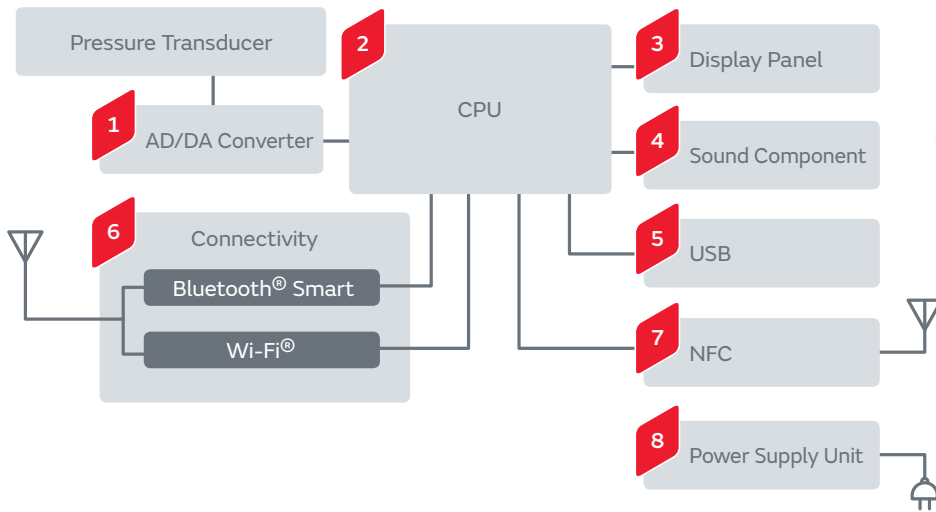

1 AD/DA Converter

- Chip Ferrite Beads BLM Series
- Thermistors NCP Series

2 CPU

- Ceramic Resonators CERALOCK® CSTCR-G/CSTCE-G/CSTCE-V Series
- Thermistors NCP/NXR Series

3 Display Panel

- 3 Terminal Capacitors NFM/NFE Series
- Chip Ferrite Beads BLM Series
- Thermistors NCP Series

4 Sound Component

- Piezoelectric Sounders PKMCS/PKLCS/PKM Series







5 USB

- Micro DC-DC Converters LXDC Series
- Ceramic Resonators CERALOCK® CSTCR-G-L/CSTCE-G-L/CSTCE-V-L/CSTCW-X Series
- Crystal Units XRC Series
- ESD Protection Devices LXES Series
- Thermistors PRG Series



6 Connectivity















- ESD Protection Devices LXES Series
- Micro DC-DC Converters LXDC Series
- Bluetooth® Smart Modules
- Wi-Fi® Modules
- Ceramic Resonators CERALOCK® CSTCR-G-L/CSTCE-G-L/CSTCE-V-L/CSTCW-X Series
- Crystal Units XRC Series
- Thermistors PRG Series

7 NFC

NFC Antennas FLAN Series 	Micro DC-DC Converters LXDC Series 	Crystal Units XRCGB Series 	Chip Ferrite Beads BLM Series 
Chip Inductors (Chip Coils) LQM/LQH/LQB Series 	Trimmer Capacitors TZY2 Series 	ESD Protection Devices LXES Series 	

8 Power Supply Unit

Thermistors NCP Series 
Thermistors PRF/PRG Series 

General Purpose	Monolithic Ceramic Capacitors	GRM Series	Coupling/Decoupling/For Step-up	
	Monolithic Ceramic Capacitors	GJM Series	High Frequency Filter Circuit	
	Resin External Electrode Monolithic Ceramic Capacitors	GRJ Series	Coupling/Decoupling/For Step-up	
	Polymer Aluminum Electrolytic Capacitors	ECAS Series	Smoothing/Transient Backup	
	Supercapacitors (EDLC)	DMF/DMT Series	Power Line/Battery Peak Assist	
	Chip Inductors (Chip Coils)	LQW/LQP/LQG Series	High Frequency Circuit-Impedance Matching/Resonance	
	Chip Inductors (Chip Coils)	LQM/LQH/DFEC Series	Voltage Conversion	
	Chip Ferrite Beads	BLM Series	Noise Suppression	
	3 Terminal Capacitors	NFM Series	Noise Suppression	
	Feed Through Chip EMI Filters	NFE Series	Noise Suppression	
	Chip Common Mode Choke Coils	DLW/DLP Series	Noise Suppression	
	Microwave Absorbers	EA Series	Noise Suppression	
	Ferrite Cores	FS Series	Noise Suppression	
	Thin Type Sandwich Cores	FSSA Series	Noise Suppression	
	Small Energy Devices	UMAC Series	Battery Backup	

Thermometer

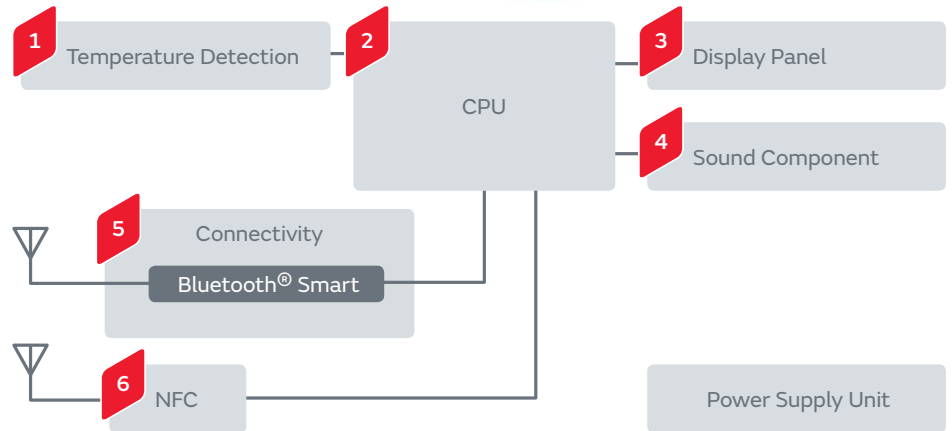

1 Temperature Detection

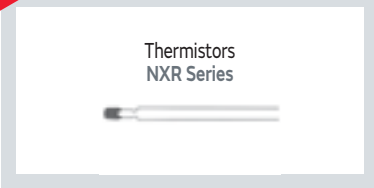

2 CPU



3 Display Panel



4 Sound Component

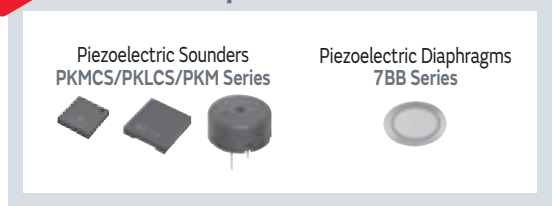

5 Connectivity

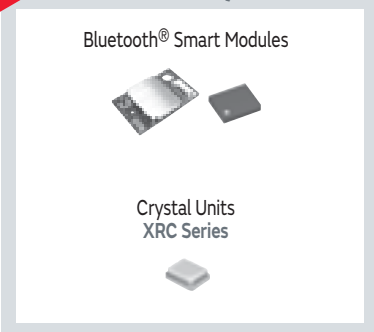

6 NFC

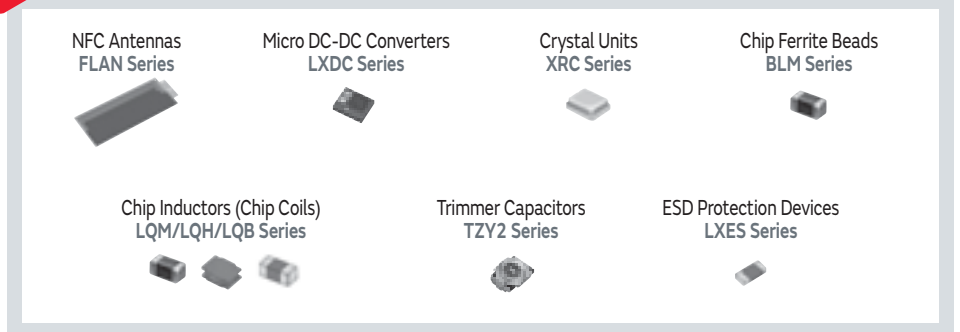

General Purpose	Monolithic Ceramic Capacitors	GRM Series	Coupling/Decoupling/For Step-up	
	Monolithic Ceramic Capacitors	GJM Series	High Frequency Filter Circuit	
	Resin External Electrode Monolithic Ceramic Capacitors	GRJ Series	Coupling/Decoupling/For Step-up	
	Polymer Aluminum Electrolytic Capacitors	ECAS Series	Smoothing/Transient Backup	
	Supercapacitors (EDLC)	DMF/DMT Series	Power Line/Battery Peak Assist	
	Chip Inductors (Chip Coils)	LQW/LQP/LQG Series	High Frequency Circuit-Impedance Matching/Resonance	
	Chip Inductors (Chip Coils)	LQM/LQH/DFEC Series	Voltage Conversion	
	Chip Ferrite Beads	BLM Series	Noise Suppression	
	3 Terminal Capacitors	NFM Series	Noise Suppression	
	Feed Through Chip EMI Filters	NFE Series	Noise Suppression	
	Chip Common Mode Choke Coils	DLW/DLP Series	Noise Suppression	
	Microwave Absorbers	EA Series	Noise Suppression	
	Ferrite Cores	FS Series	Noise Suppression	
Thin Type Sandwich Cores	FSSA Series	Noise Suppression		
Small Energy Devices	UMAC Series	Battery Backup		

Blood Glucose Meter



1 AD/DA Converter

Chip Ferrite Beads
BLM Series



Thermistors
NCP Series



2 CPU

Ceramic Resonators CERALOCK®
CSTCR-G/CSTCE-G/CSTCE-V Series



Thermistors
NCP/NXR Series



5 USB

Ceramic Resonators CERALOCK®
CSTCR-G-L/CSTCE-G-L/CSTCE-V-L/CSTCW-X Series



Crystal Units
XRC Series



Thermistors
PRG Series



6 Connectivity

Bluetooth® Smart Modules



Wi-Fi® Modules



Ceramic Resonators CERALOCK®
CSTCR-G-L/CSTCE-G-L/CSTCE-V-L/CSTCW-X Series



Crystal Units
XRC Series



Thermistors
PRG Series



General Purpose

Monolithic Ceramic Capacitors

GRM Series

Coupling/Decoupling/For Step-up



Monolithic Ceramic Capacitors

GJM Series

High Frequency Filter Circuit



Resin External Electrode Monolithic Ceramic Capacitors

GRJ Series

Coupling/Decoupling/For Step-up



Polymer Aluminum Electrolytic Capacitors

ECAS Series

Smoothing/Transient Backup



Supercapacitors (EDLC)

DMF/DMT Series

Power Line/Battery Peak Assist



Chip Inductors (Chip Coils)

LQW/LQP/LQG Series

High Frequency Circuit-Impedance Matching/Resonance



Chip Inductors (Chip Coils)

LQM/LQH/DFEC Series

Voltage Conversion



Chip Ferrite Beads

BLM Series

Noise Suppression



3 Terminal Capacitors

NFM Series

Noise Suppression



Feed Through Chip EMI Filters

NFE Series

Noise Suppression



Chip Common Mode Choke Coils

DLW/DLP Series

Noise Suppression



Microwave Absorbers

EA Series

Noise Suppression



Ferrite Cores

FS Series

Noise Suppression



Thin Type Sandwich Cores

FSSA Series

Noise Suppression



Small Energy Devices

UMAC Series

Battery Backup

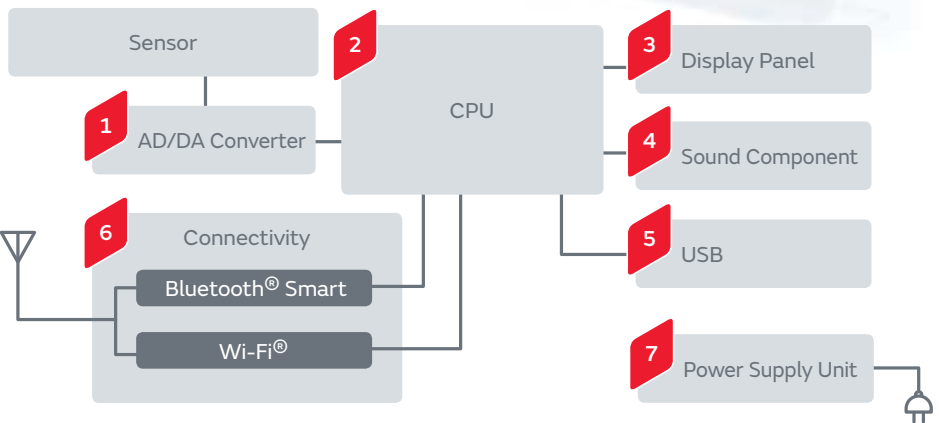

3 Display Panel

3 Terminal Capacitors
NFM Series



Chip Ferrite Beads
BLM Series



Thermistors
NCP Series



4 Sound Component

Piezoelectric Sounders
PKMCS/PKLCS/PKM Series

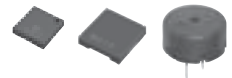

Piezoelectric Diaphragms
7BB Series



7 Power Supply Unit

Thermistors
NCP Series



Thermistors
PRF/PRG Series



Diagnostic Imaging Apparatus

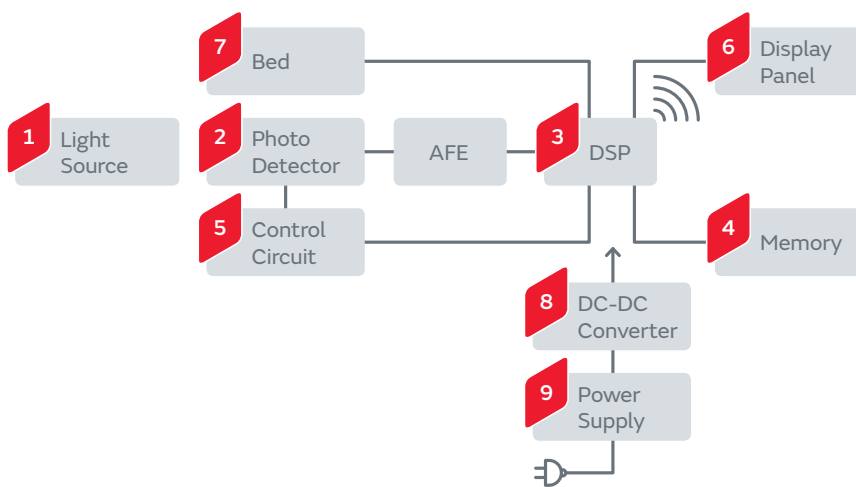

1 Light Source

High Voltage Ceramic Capacitors
DHS/DHK Series

2 Photo Detector

Thermistors
NCP/PRF Series

3 DSP

Ceramic Resonators CERALOCK®
CSTLS/CSTCE/CSTCR Series

Crystal Units
XRC Series

4 Memory

<p>Isolated DC-DC Converters MYB Series</p>	<p>Non-isolated DC-DC Converters OKL/MPDR/MPDT/MYS Series</p>	<p>Micro DC-DC Converters LXDC Series</p>	<p>Supercapacitors (EDLC) DMF/DMT Series</p>	<p>Small Energy Devices UMAC Series</p>
---	---	---	--	---

5 Control Circuit

<p>Isolated DC-DC Converters MYB Series</p>	<p>Non-isolated DC-DC Converters OKL/MPDR/MPDT Series</p>
<p>Micro DC-DC Converters LXDC Series</p>	<p>Ceramic Resonators CERALOCK® CSTCE/CSTCR Series</p>

6 Display Panel

<p>Metal Terminal Type Monolithic Ceramic Capacitors KRM Series</p>	<p>Ceramic Resonators CERALOCK® CSTCE/CSTCR Series</p>
<p>Piezoelectric Sounders PKMCS/PKLCS Series</p>	<p>Thermistors PRF/PRG Series</p>

7 Bed

Inclinometers
SCA100T/103T Series

8 DC-DC Converter

<p>Micro DC-DC Converters LXDC Series</p>	<p>Metal Terminal Type Monolithic Ceramic Capacitors KRM Series</p>	<p>Polymer Aluminum Electrolytic Capacitors ECAS Series</p>	<p>Thermistors NCP/PRF Series</p>
---	---	---	---------------------------------------

9 Power Supply

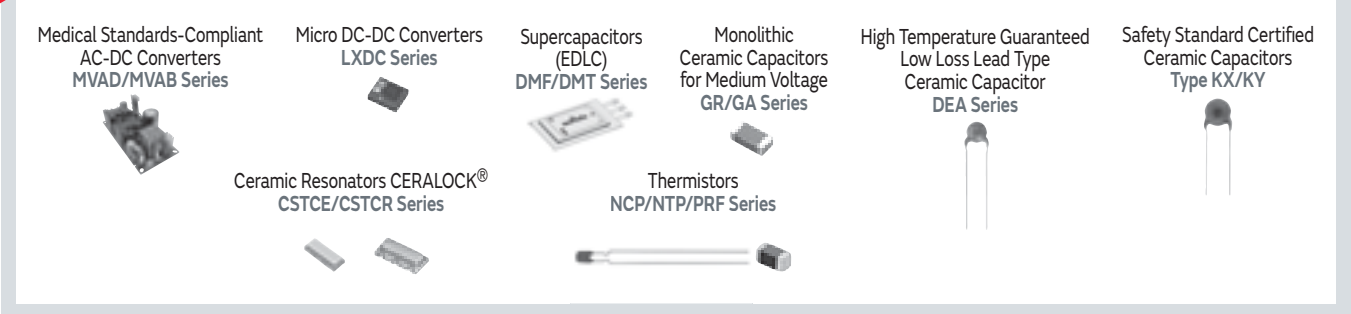

General Purpose	Monolithic Ceramic Capacitors	GRM Series	Coupling/Decoupling/For Step-up	
	Monolithic Ceramic Capacitors	GJM Series	High Frequency Filter Circuit	
	Resin External Electrode Monolithic Ceramic Capacitors	GRJ Series	Coupling/Decoupling/For Step-up	
	Polymer Aluminum Electrolytic Capacitors	ECAS Series	Smoothing/Transient Backup	
	Chip Inductors (Chip Coils)	LQW/LQP/LQG Series	High Frequency Circuit-Impedance Matching/Resonance	
	Chip Inductors (Chip Coils)	LQM/LQH/DFEC Series	Voltage Conversion	
	Chip Ferrite Beads	BLM Series	Noise Suppression	
	3 Terminal Capacitors	NFM Series	Noise Suppression	
	Feed Through Chip EMI Filters	NFE Series	Noise Suppression	
	Chip Common Mode Choke Coils	DLW/DLP Series	Noise Suppression	
	Microwave Absorbers	EA Series	Noise Suppression	
	Ferrite Cores	FS Series	Noise Suppression	
	Thin Type Sandwich Cores	FSSA Series	Noise Suppression	

Security Camera

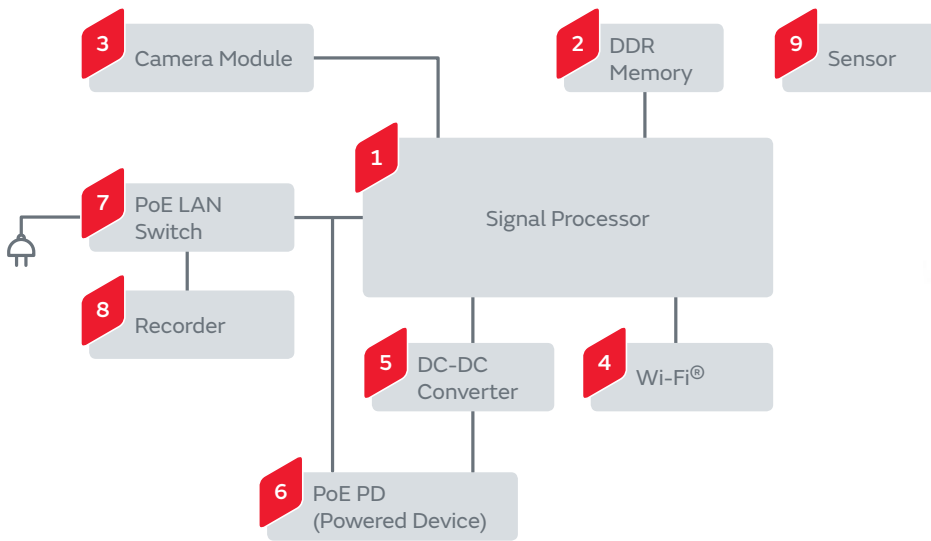

1 Signal Processor

Polymer Aluminum Electrolytic Capacitors ECAS Series



Ceramic Resonators CERALOCK® CSTCE/CSTCR Series



Crystal Units XRC Series



3 Terminal Capacitors NFM Series



Thermistors NCP/PRF Series



2 DDR Memory

Micro DC-DC Converters LXDC Series



Polymer Aluminum Electrolytic Capacitors ECAS Series



Chip Ferrite Beads BLM Series



3 Camera Module

Chip Ferrite Beads BLM Series



4 Wi-Fi®

Wi-Fi® Modules



Micro DC-DC Converters LXDC Series



Chip Inductors (Chip Coils) LQB Series



Chip Multilayer LC Filters LF Series



Chip Multilayer Diplexers LFD Series



Chip Multilayer Hybrid Baluns LDB/LDM Series



Chip Multilayer Hybrid Couplers LDC/LDJ Series



5 DC-DC Converter

Micro DC-DC Converters LXDC Series



Metal Terminal Type Monolithic Ceramic Capacitors KRM Series



Polymer Aluminum Electrolytic Capacitors ECAS Series



Power Inductors LQH/DFEC Series





Thermistors NCP/PRF Series





6 PoE PD (Powered Device)

Micro DC-DC Converters LXDC Series 

Monolithic Ceramic Capacitors for Medium Voltage GR/GA Series 

High Temperature Guaranteed Low Loss Lead Type Ceramic Capacitor DEA Series 

Crystal Units XRC Series 

Thermistors NCP/NXRT/NTP/PRF Series 

7 PoE LAN Switch

Micro DC-DC Converters LXDC Series 

Monolithic Ceramic Capacitors for Medium Voltage GR/GA Series 

High Temperature Guaranteed Low Loss Lead Type Ceramic Capacitor DEA Series 

Safety Standard Certified Ceramic Capacitors Type KX/KY 

Metal Terminal Type Monolithic Ceramic Capacitors KRM Series 

Crystal Units XRC Series 

Thermistors NCP/NXRT/NTP/PRF Series 

8 Recorder

Shock Sensors PKGS Series 

Polymer Aluminum Electrolytic Capacitors ECAS Series 













Ceramic Resonators CERALOCK® CSTCE Series 

Crystal Units XRC Series 

Thermistors NCP/PRF Series 

9 Sensor

Pyroelectric Infrared Sensors IRA Series 



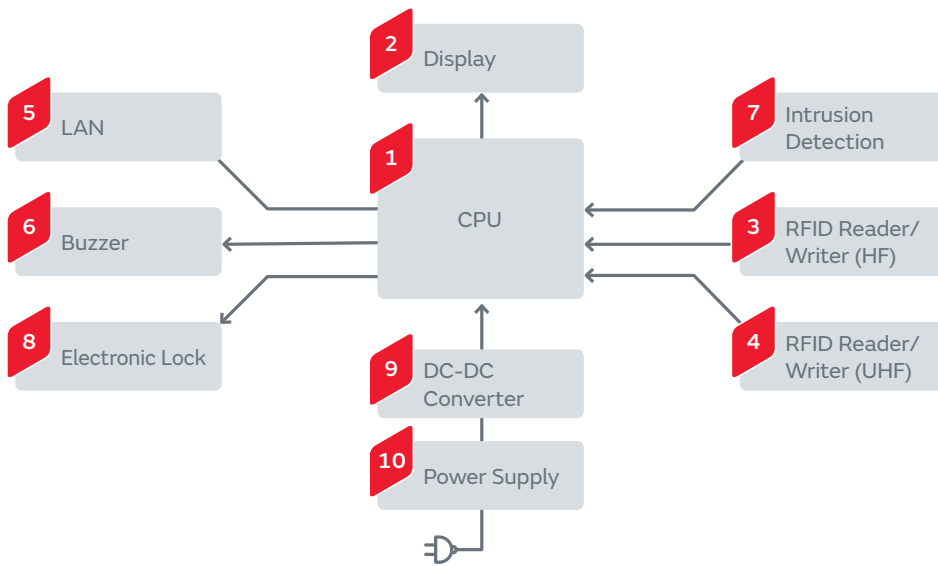

General Purpose	Monolithic Ceramic Capacitors	GRM Series	Coupling/Decoupling/For Step-up	
	Monolithic Ceramic Capacitors	GJM Series	High Frequency Filter Circuit	
	Resin External Electrode Monolithic Ceramic Capacitors	GRJ Series	Coupling/Decoupling/For Step-up	
	Polymer Aluminum Electrolytic Capacitors	ECAS Series	Smoothing/Transient Backup	
	Chip Inductors (Chip Coils)	LQW/LQP/LQG Series	High Frequency Circuit-Impedance Matching/Resonance	
	Chip Inductors (Chip Coils)	LQM/LQH/DFEC Series	Voltage Conversion	
	Chip Ferrite Beads	BLM Series	Noise Suppression	
	3 Terminal Capacitors	NFM Series	Noise Suppression	
	Feed Through Chip EMI Filters	NFE Series	Noise Suppression	
	Chip Common Mode Choke Coils	DLW/DLP Series	Noise Suppression	
	Microwave Absorbers	EA Series	Noise Suppression	
	Ferrite Cores	FS Series	Noise Suppression	
	Thin Type Sandwich Cores	FSSA Series	Noise Suppression	

Entrance and Exit Management System





















<p>1 CPU</p> <p>Non-isolated DC-DC Converters OKL/MPDR/MPDT Series</p> <p>Ceramic Resonators CERALOCK® CSTLS/CSTCE/CSTCR Series</p> <p>Crystal Units XRC Series</p>	<p>2 Display</p> <p>Micro DC-DC Converters LXDC Series</p> <p>Ceramic Resonators CERALOCK® CSTCE Series</p> <p>ESD Protection Devices LXES Series</p> <p>Thermistors NCP/PRF Series</p>	<p>3 RFID Reader/Writer (HF)</p> <p>Crystal Units XRC Series</p>	
<p>4 RFID Reader/Writer (UHF)</p> <p>Crystal Units XRC Series</p>	<p>5 LAN</p> <p>Polymer Aluminum Electrolytic Capacitors ECAS Series</p> <p>Crystal Units XRC Series</p> <p>ESD Protection Devices LXES Series</p> <p>Thermistors PRG Series</p>		
<p>6 Buzzer</p> <p>Piezoelectric Sounders PKMCS/PKLCs/PKM Series</p>	<p>7 Intrusion Detection</p> <p>Pyroelectric Infrared Sensors IRA Series</p> <p>Ultrasonic Sensors MA Series</p> <p>Magnetic Sensors (AMR Sensors) MR Series</p>		<p>8 Electronic Lock</p> <p>Supercapacitors (EDLC) DMF/DMT Series</p>

9 DC-DC Converter

Micro DC-DC Converters LXDC Series 	Thermistors NCP/PRF Series 
Polymer Aluminum Electrolytic Capacitors ECAS Series 	Metal Terminal Type Monolithic Ceramic Capacitors KRM Series 

10 Power Supply

Micro DC-DC Converters LXDC Series 	Monolithic Ceramic Capacitors for Medium Voltage GR/GA Series 	High Temperature Guaranteed Low Loss Lead Type Ceramic Capacitor DEA Series 
Safety Standard Certified Ceramic Capacitors Type KX/KY 	Ceramic Resonators CERALOCK® CSTCE/CSTCR Series 	Thermistors NCP/NTP/PRF Series 

General Purpose	Monolithic Ceramic Capacitors	GRM Series	Coupling/Decoupling/For Step-up	
	Monolithic Ceramic Capacitors	GJM Series	High Frequency Filter Circuit	
	Resin External Electrode Monolithic Ceramic Capacitors	GRJ Series	Coupling/Decoupling/For Step-up	
	Polymer Aluminum Electrolytic Capacitors	ECAS Series	Smoothing/Transient Backup	
	Chip Inductors (Chip Coils)	LQW/LQP/LQG Series	High Frequency Circuit-Impedance Matching/Resonance	
	Chip Inductors (Chip Coils)	LQM/LQH/DFEC Series	Voltage Conversion	
	Chip Ferrite Beads	BLM Series	Noise Suppression	
	3 Terminal Capacitors	NFM Series	Noise Suppression	
	Feed Through Chip EMI Filters	NFE Series	Noise Suppression	
	Chip Common Mode Choke Coils	DLW/DLP Series	Noise Suppression	
	Microwave Absorbers	EA Series	Noise Suppression	
	Ferrite Cores	FS Series	Noise Suppression	
	Thin Type Sandwich Cores	FSSA Series	Noise Suppression	

Electronic POS

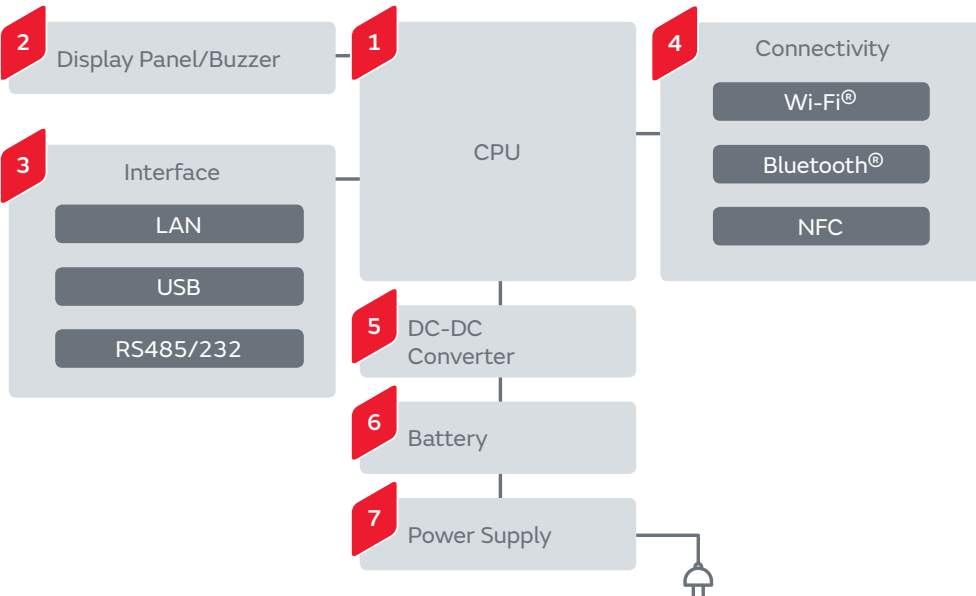

1 CPU

- Supercapacitors (EDLC) DMF/DMT Series
- ESD Protection Devices LXES Series
- Micro DC-DC Converters LXDC Series

3 Interface

- Polymer Aluminum Electrolytic Capacitors ECAS Series
- Crystal Units XRC Series
- Chip Common Mode Choke Coils DLW/DLP Series
- ESD Protection Devices LXES Series
- Thermistors PRG Series

2 Digital Panel/Buzzer

- Metal Terminal Type Monolithic Ceramic Capacitors KCM Series
- Ceramic Resonators CERALOCK® CSTCE/CSTCR Series
- Power Inductors LQH Series
- Thermistors PRF/PRG Series
- Piezoelectric Sounders PKMCS/PKLC Series
- Piezoelectric Buzzers PKB Series

4 Connectivity

- Bluetooth® Modules
- Bluetooth® - Wi-Fi® Combo Modules
- Bluetooth® Smart Modules
- Wi-Fi® Modules
- NFC Antennas FLAN Series
- Crystal Units XRC Series

5 DC-DC Converter

- Micro DC-DC Converters LXDC Series
- Metal Terminal Type Monolithic Ceramic Capacitors KRM Series
- Polymer Aluminum Electrolytic Capacitors ECAS Series
- Power Inductors LQH/DEM/DFEC Series
- Thermistors NCP/PRF Series

6 Battery

- Thermistors NCP/PRF/PRG Series

7 Power Supply

Monolithic Ceramic Capacitors for Medium Voltage GR/GA Series



High Temperature Guaranteed Low Loss Lead Type Ceramic Capacitor DEA Series



Safety Standard Certified Ceramic Capacitors Type KX/KY



AC Line Filters PLA/PLY Series



Thermistors NCP/NTP/PRF/PTG Series



General Purpose

Monolithic Ceramic Capacitors	GRM Series	Coupling/Decoupling/For Step-up	
Monolithic Ceramic Capacitors	GJM Series	High Frequency Filter Circuit	
Resin External Electrode Monolithic Ceramic Capacitors	GRJ Series	Coupling/Decoupling/For Step-up	
Polymer Aluminum Electrolytic Capacitors	ECAS Series	Smoothing/Transient Backup	
Chip Inductors (Chip Coils)	LQW/LQP/LQG Series	High Frequency Circuit-Impedance Matching/Resonance	
Chip Inductors (Chip Coils)	LQM/LQH/DFEC Series	Voltage Conversion	
Chip Ferrite Beads	BLM Series	Noise Suppression	
3 Terminal Capacitors	NFM Series	Noise Suppression	
Feed Through Chip EMI Filters	NFE Series	Noise Suppression	
Chip Common Mode Choke Coils	DLW/DLP Series	Noise Suppression	
Microwave Absorbers	EA Series	Noise Suppression	
Ferrite Cores	FS Series	Noise Suppression	
Thin Type Sandwich Cores	FSSA Series	Noise Suppression	
Small Energy Devices	UMAC Series	Battery Backup	

Heavy Duty Vehicles

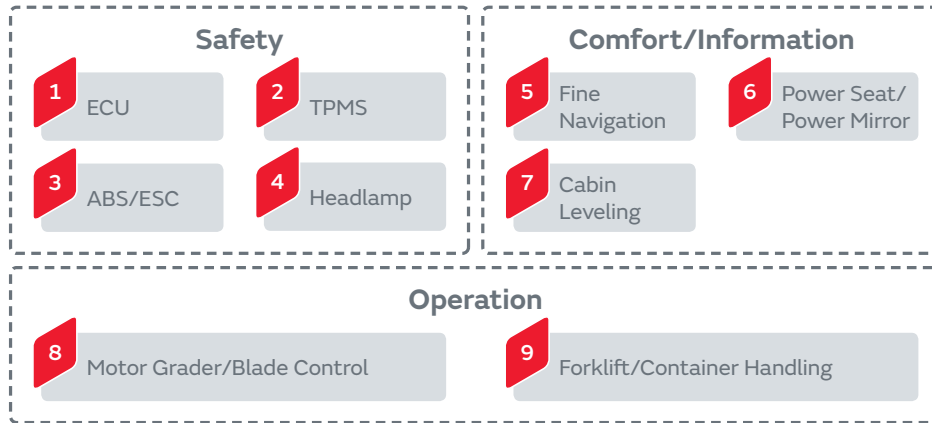

Safety

1 ECU

Low Temperature Co-fired Ceramics (LTCC) Ceramic Multilayer Substrates LFC® 	Metal Terminal Type Monolithic Ceramic Capacitors KCM Series 	Monolithic Ceramic Capacitors for Automotive GCM Series 	Resin External Electrode Monolithic Ceramic Capacitors GCJ Series 	Monolithic Ceramic Capacitor for Conductive Adhesives GCG Series 	Monolithic Ceramic Capacitor for Conductive Adhesives (Ni/Pd Plating Structure) GCB Series
Radial Lead Type Monolithic Ceramic Capacitors RH/RCE Series 	Ceramic Resonators CERALOCK® CSTCE/CSTCR Series 	Crystal Units XRCGB/XRCHA Series 	Accelerometers SCA Series 	Gyro Sensors SCC Series 	Thermistors PRF/PTG Series

2 TPMS

Shock Sensors PKGS Series 	Ceramic Filters CERAFIL® SFEFC Series
Ceramic Resonators CERALOCK® CSTCE/CSTCR Series 	Crystal Units XRCGB/XRCHA Series
Pressure Sensor Elements SCB10H Series 	Thermistors PRF Series

3 ABS/ESC

Low Temperature Co-fired Ceramics (LTCC) Ceramic Multilayer Substrates LFC® 	Metal Terminal Type Monolithic Ceramic Capacitors KCM Series 	Monolithic Ceramic Capacitors for Automotive GCM Series 	Resin External Electrode Monolithic Ceramic Capacitors GCJ Series
Monolithic Ceramic Capacitor for Conductive Adhesives GCG Series 	Monolithic Ceramic Capacitor for Conductive Adhesives (Ni/Pd Plating Structure) GCB Series 	Ceramic Resonators CERALOCK® CSTCE/CSTCR Series 	
Crystal Units XRCGB/XRCHA Series 	Accelerometers SCA Series 	Gyro Sensors SCC Series 	Thermistors for Conductive Glue Mounting NCG18 Series

4 Headlamp

Monolithic Ceramic Capacitors for Automotive GCM Series 	Resin External Electrode Monolithic Ceramic Capacitors GCJ Series 	Ceramic Resonators CERALOCK® CSTCE/CSTCR Series 	Crystal Units XRCGB/XRCHA Series 	Thermistors for Conductive Glue Mounting NCG18 Series 	Low Temperature Co-fired Ceramics (LTCC) Ceramic Multilayer Substrates LFC®
---	---	---	--------------------------------------	---	---

Comfort/Information

5 Fine Navigation

Accelerometers SCA Series

Gyro Sensors SCC Series

MEMS Gyro Sensors SCR Series

6 Power Seat/Power Mirror

Piezoelectric Sounders PKLCS Series

Ceramic Resonators CERALOCK® CSTCE/CSTCR Series

Crystal Units XRCGB/XRCHA Series

Thermistors PRF/PTG Series

7 Cabin Leveling

Accelerometers SCA Series

Ceramic Resonators CERALOCK® CSTCE/CSTCR Series

Gyro Sensors SCC Series

Crystal Units XRCGB/XRCHA Series

Operation

8 Motor Grader/Blade Control

Accelerometers SCA Series

Gyro Sensors SCC Series

MEMS Gyro Sensors SCR Series

Ceramic Resonators CERALOCK® CSTCE/CSTCR Series

Crystal Units XRCGB/XRCHA Series

9 Forklift/Container Handling

Accelerometers SCA Series

Ceramic Resonators CERALOCK® CSTCE/CSTCR Series

Crystal Units XRCGB/XRCHA Series

General Purpose	Monolithic Ceramic Capacitors	GRT Series	Coupling/Decoupling	
	Monolithic Ceramic Capacitors for Medium Voltage	GRM Series	For Snubber	
	Resin External Electrode Monolithic Ceramic Capacitors	GRJ Series	Coupling/Decoupling/For Step-up	
	Radial Lead Type Monolithic Ceramic Capacitors	RCE Series	Noise Suppression/Decoupling	
	Chip Inductors (Chip Coils)	LQM/LQH/DFEC Series	Voltage Conversion	
	Chip Ferrite Beads	BLM Series	Noise Suppression	
	EMI Suppression Filters	NFL/NFE Series	Noise Suppression	
	Chip Common Mode Choke Coils	DLW Series	Common Mode Noise Suppression	
	Ferrite Cores	FS Series	Noise Suppression	

General Purpose (High Reliability)	Monolithic Ceramic Capacitors For Automotive	GCM Series	Coupling/Decoupling		150°C
	Radial Lead Type Monolithic Ceramic Capacitors	RCE Series	Noise Suppression/Decoupling		125°C
	Radial Lead Type Monolithic Ceramic Capacitors	RH Series	Noise Suppression/Decoupling		150°C
	Chip Inductors (Chip Coils)	LQH32CH/MBH/DFEH Series	Voltage Conversion		105°C
	Chip Inductors (Chip Coils)	LQG15HH Series	Impedance Matching/Choke		125°C
	Chip Ferrite Beads	BLM_SH Series	Noise Suppression		125°C
	3 Terminal Capacitors	NFM_H/NFE_H Series	Noise Suppression		125°C
	Chip Common Mode Choke Coils	DLW31/DLW43 Series	Common Mode Noise Suppression		125°C

105°C 105°C max. 125°C 125°C max. 150°C 150°C max.

Industrial Automation

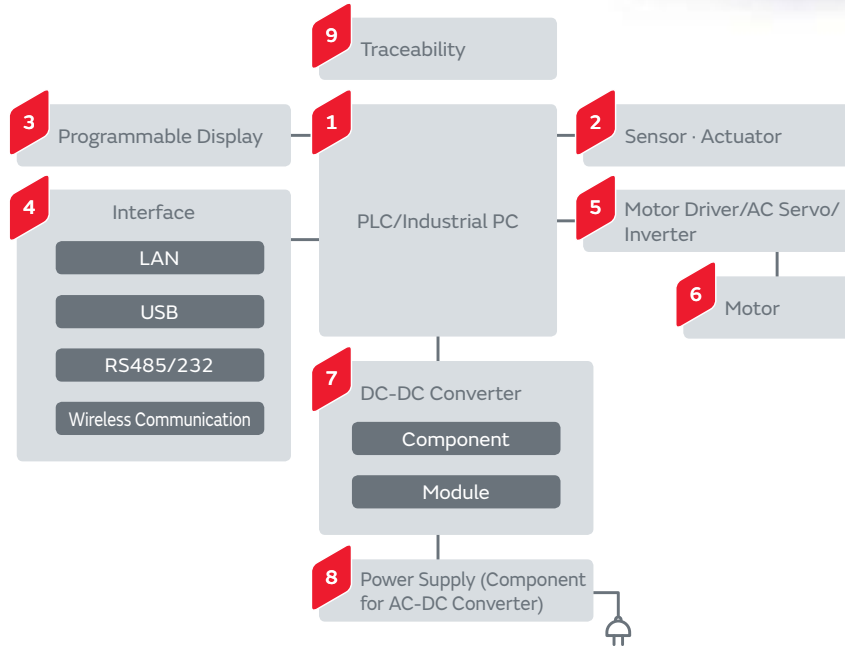

1 PLC/Industrial PC

<p>Polymer Aluminum Electrolytic Capacitors ECAS Series</p>	<p>Crystal Units XRC Series</p>	<p>Chip Ferrite Beads BLM Series</p>
<p>3 Terminal Capacitors NFM Series</p>	<p>Supercapacitors (EDLC) DMF/DMT Series</p>	<p>Thermistors NCP/PRF Series</p>

2 Sensor · Actuator

<p>Pyroelectric Infrared Sensors IRA Series</p>	<p>Magnetic Sensors (AMR Sensors) MR Series</p>
---	---

4 Interface (LAN · USB · RS485/232 · Wireless Communication)

<p>Polymer Aluminum Electrolytic Capacitors ECAS Series</p>	<p>Crystal Units XRC Series</p>	<p>Chip Common Mode Choke Coils DLW/DLP Series</p>
<p>ESD Protection Devices LXES Series</p>	<p>Thermistors PRG Series</p>	<p>Wireless Communication Modules Based on the ISA100 Wireless™ Standard</p>

3 Programmable Display

<p>Micro DC-DC Converters LXDC Series</p>	<p>Ceramic Resonators CERALOCK® CSTCE/CSTCR Series</p>
<p>Crystal Units XRC Series</p>	<p>Power Inductors LQH Series</p>
<p>Supercapacitors (EDLC) DMF/DMT Series</p>	<p>Chip Common Mode Choke Coils DLW/DLP Series</p>

5 Motor Driver/AC Servo/Inverter

<p>Monolithic Ceramic Capacitors for Medium Voltage GR/GA Series</p>	<p>High Temperature Guaranteed Low Loss Lead Type Ceramic Capacitor DEA Series</p>	<p>Ceramic Resonators CERALOCK® CSTCE/CSTCR Series</p>
<p>Crystal Units XRC Series</p>	<p>Large Current Common Mode Choke Coils PLT10HH Series</p>	<p>Thermistors PRF/PTG Series</p>

6 Motor

Rotary Sensors



7 DC-DC Converter (Module - Component)

Isolated DC-DC Converters
MYB Series



Non-isolated DC-DC Converters
OKL/MPD/MYS Series



Micro DC-DC Converters
LXDC Series



Metal Terminal Type
Monolithic Ceramic Capacitors
KRM Series



Polymer Aluminum Electrolytic Capacitors
ECAS Series



Power Inductors
LQH Series



Thermistors
NCP/PRF Series



8 Power Supply (Component for AC-DC Converter)

Micro DC-DC Converters
LXDC Series



Monolithic Ceramic Capacitors
for Medium Voltage
GR/GA Series



High Temperature Guaranteed
Low Loss Lead Type Ceramic Capacitor
DEA Series



Safety Standard Certified
Ceramic Capacitors
Type KX/KY



Ceramic Resonators
CERALOCK®
CSTCE/CSTCR Series



Thermistors
NCP/NTP/PRF Series



9 Traceability

RFID Device MAGICSTRAP®
LXMS Series



Supercapacitors (EDLC)
DMF/DMT Series



General Purpose	Monolithic Ceramic Capacitors	GRM Series	Coupling/Decoupling/For Step-up	
	Monolithic Ceramic Capacitors	GJM Series	High Frequency Filter Circuit	
	Resin External Electrode Monolithic Ceramic Capacitors	GRJ Series	Coupling/Decoupling/For Step-up	
	Polymer Aluminum Electrolytic Capacitors	ECAS Series	Smoothing/Transient Backup	
	Chip Inductors (Chip Coils)	LQW/LQP/LQG Series	High Frequency Circuit-Impedance Matching/Resonance	
	Chip Inductors (Chip Coils)	LQM/LQH/DFEC Series	Voltage Conversion	
	Chip Ferrite Beads	BLM Series	Noise Suppression	
	3 Terminal Capacitors	NFM Series	Noise Suppression	
	Feed Through Chip EMI Filters	NFE Series	Noise Suppression	
	Chip Common Mode Choke Coils	DLW/DLP Series	Noise Suppression	
	Microwave Absorbers	EA Series	Noise Suppression	
	Ferrite Cores	FS Series	Noise Suppression	
	Thin Type Sandwich Cores	FSSA Series	Noise Suppression	
	Small Energy Devices	UMAC Series	Battery Backup	

3D Printer

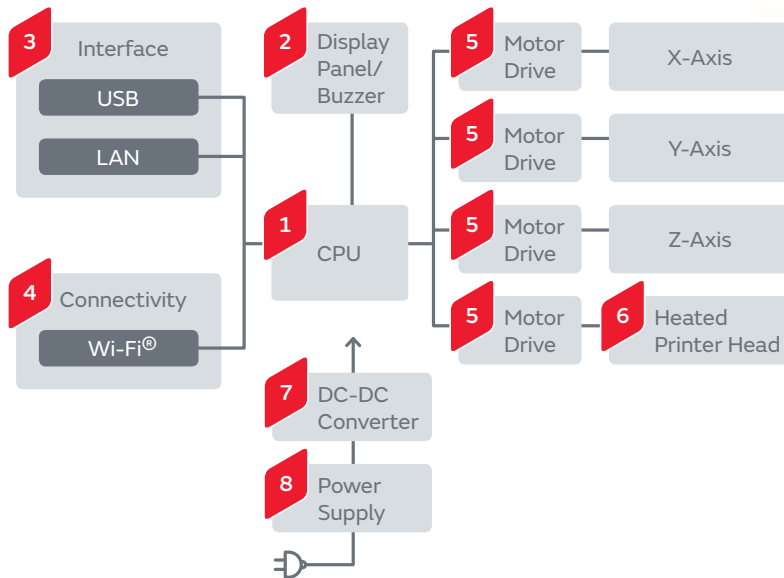

1 CPU

Isolated DC-DC Converters
MYB Series



Non-isolated DC-DC Converters
OKL/MPDR/MPDT Series

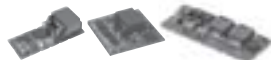

Ceramic Resonators CERALOCK®
CSTLS/CSTCE/CSTCR Series



Polymer Aluminum Electrolytic Capacitors
ECAS Series



Crystal Units
XRC Series



Thermistors
NCP/PRF Series



2 Display Panel/Buzzer

Ceramic Resonators CERALOCK®
CSTLS/CSTCE/CSTCR Series



Piezoelectric Sounders
PKMCS/PKLCs/PKM Series



3 Interface

Polymer Aluminum Electrolytic Capacitors
ECAS Series



Crystal Units
XRC Series



Chip Common Mode Choke Coils
DLW/DLP Series



ESD Protection Devices
LXES Series



Thermistors
PRG Series



4 Connectivity

Wi-Fi® Modules



Micro DC-DC Converters
LXDC Series



Ceramic Resonators CERALOCK®
CSTCE/CSTCR Series



Crystal Units
XRC Series



Chip Inductors (Chip Coils)
LQB Series



ESD Protection Devices
LXES Series



5 Motor Drive

Isolated DC-DC Converters
MYB Series



Non-isolated DC-DC Converters
OKL/MPDR/MPDT Series

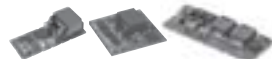

Monolithic Ceramic Capacitors for Medium Voltage
GR/GA Series



High Temperature Guaranteed Low Loss Lead Type Ceramic Capacitor
DEA Series



Ceramic Resonators CERALOCK®
CSTCE/CSTCR Series



Crystal Units
XRC Series



Large Current Common Mode Choke Coils
PLT10HH Series



Thermistors
PRF/PTG Series



6 Heated Printer Head

Thermistors
NCP/PRF Series



7 DC-DC Converter

Micro DC-DC Converters
LXDC Series



Metal Terminal Type
Monolithic Ceramic Capacitors
KRM Series



Polymer Aluminum
Electrolytic Capacitors
ECAS Series



Thermistors
NCP/PRF Series



8 Power Supply

Micro DC-DC Converters
LXDC Series



Monolithic Ceramic Capacitors
for Medium Voltage
GR/GA Series



High Temperature Guaranteed
Low Loss Lead Type Ceramic Capacitor
DEA Series



Safety Standard Certified
Ceramic Capacitors
Type KX/KY



Thermistors
NCP/NTP/PRF/PRG Series



General Purpose

Monolithic Ceramic Capacitors	GRM Series	Coupling/Decoupling/For Step-up	
Monolithic Ceramic Capacitors	GJM Series	High Frequency Filter Circuit	
Resin External Electrode Monolithic Ceramic Capacitors	GRJ Series	Coupling/Decoupling/For Step-up	
Polymer Aluminum Electrolytic Capacitors	ECAS Series	Smoothing/Transient Backup	
Chip Inductors (Chip Coils)	LQW/LQP/LQG Series	High Frequency Circuit-Impedance Matching/Resonance	
Chip Inductors (Chip Coils)	LQM/LQH/DFEC Series	Voltage Conversion	
Chip Ferrite Beads	BLM Series	Noise Suppression	
3 Terminal Capacitors	NFM Series	Noise Suppression	
Feed Through Chip EMI Filters	NFE Series	Noise Suppression	
Chip Common Mode Choke Coils	DLW/DLP Series	Noise Suppression	
Microwave Absorbers	EA Series	Noise Suppression	
Ferrite Cores	FS Series	Noise Suppression	
Thin Type Sandwich Cores	FSSA Series	Noise Suppression	
Small Energy Devices	UMAC Series	Battery Backup	

Lighting

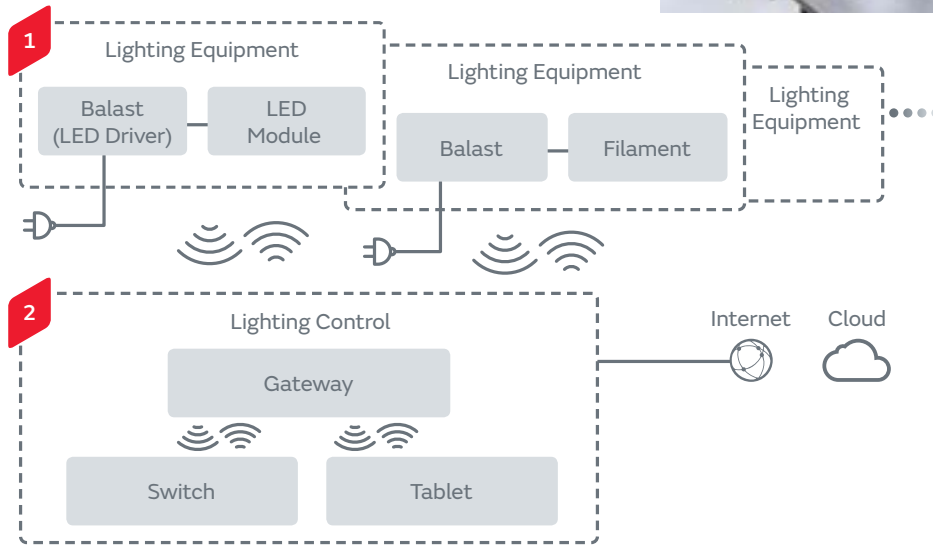

1 Lighting Equipment

Ballast for LED Lighting



Monolithic Ceramic Capacitors for Medium Voltage GR/GA Series



High Temperature Guaranteed Low Loss Lead Type Ceramic Capacitor DEA Series



Safety Standard Certified Ceramic Capacitors Type KX/KY



Piezoelectric Sounders PKMCS/PK LCS Series



Wi-Fi® Modules



Sub-GHz Modules



Thermistors NCP/NTP/PRF/PRG/PTG Series



AC Line Filters PLA/PLH/PLY Series



2 Lighting Control

Wi-Fi® Modules



Sub-GHz Modules



Pyroelectric Infrared Sensors IRA Series



Crystal Units XRC Series



Ceramic Resonators CERALOCK® CSTLS/CSTCE/CSTCR Series



General Purpose	Monolithic Ceramic Capacitors	GRM Series	Coupling/Decoupling/For Step-up	
	Monolithic Ceramic Capacitors	GJM Series	High Frequency Filter Circuit	
	Resin External Electrode Monolithic Ceramic Capacitors	GRJ Series	Coupling/Decoupling/For Step-up	
	Polymer Aluminum Electrolytic Capacitors	ECAS Series	Smoothing/Transient Backup	
	Chip Inductors (Chip Coils)	LQW/LQP/LQG Series	High Frequency Circuit-Impedance Matching/Resonance	
	Chip Inductors (Chip Coils)	LQM/LQH/DFEC Series	Voltage Conversion	
	Chip Ferrite Beads	BLM Series	Noise Suppression	
	3 Terminal Capacitors	NFM Series	Noise Suppression	
	Feed Through Chip EMI Filters	NFE Series	Noise Suppression	
	Chip Common Mode Choke Coils	DLW/DLP Series	Noise Suppression	
	Microwave Absorbers	EA Series	Noise Suppression	
	Ferrite Cores	FS Series	Noise Suppression	
	Thin Type Sandwich Cores	FSSA Series	Noise Suppression	
Small Energy Devices	UMAC Series	Battery Backup		

Memo

Design Support Tool "SimSurfing"

<http://www.murata.com/simsurfing/>

This is the latest tool to get the electrical characteristics for capacitors, inductors, and EMI suppression filters, etc., and to simulate thermistors' behavior !



■ Characteristics viewer
You can easily search and download the following data for [Monolithic Ceramic Capacitors], [Three-terminal Capacitors], [RF Inductors], [Ferrite Beads] and [Common Mode Choke Coils], etc.

■ Component performance simulator
You can search by the simulation on simple circuits for [NTC Thermistors] and [PTC Thermistors(POSISTOR®)].

■ Selection tool
According to conditions of use, you can select our medium voltage capacitors and power inductors on [Medium Voltage Capacitors] and [Power Inductors].

■ Search tool
You can search CERALOCK® and crystal units that are most suitable for your IC and access information about the recommended circuit constant setting on [Timing Devices].

■ Usage example of "Monolithic Ceramic Capacitors"

1 Select the products

- (1) By characteristics/type
- (2) By part number

2 Show graph

Click a button on each tab of "Basic," "S-parameter," and "Detailed."

3 Data download

- Click each purple button in this area.
- Click "CSV output" button.

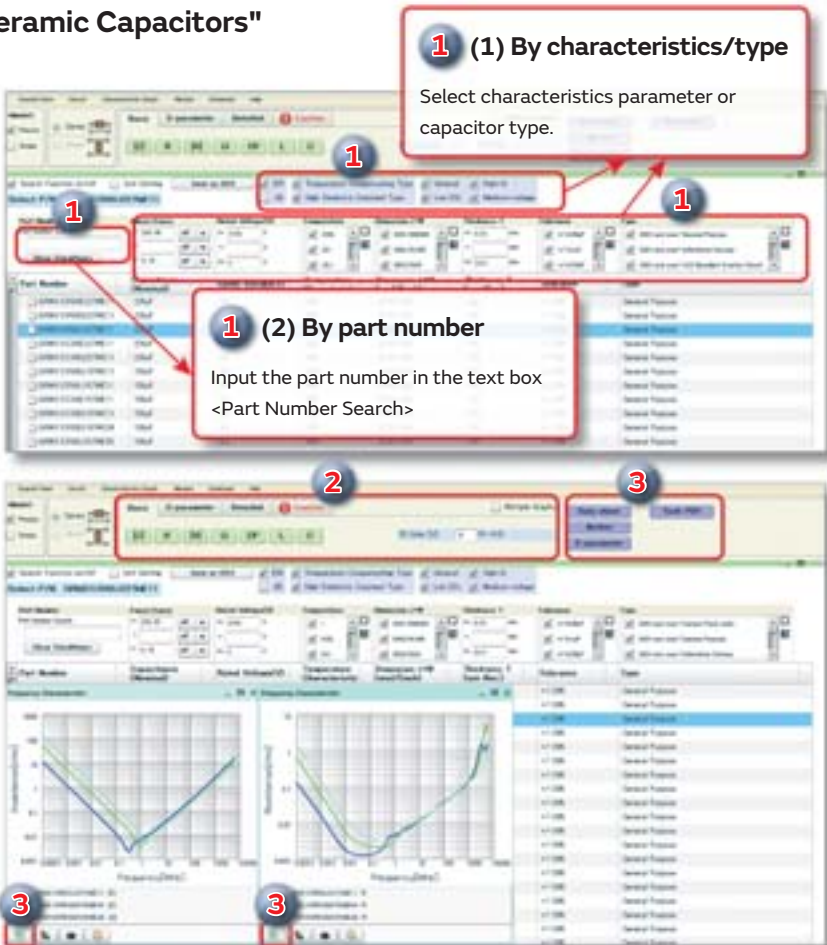

1 (1) By characteristics/type
Select characteristics parameter or capacitor type.

1 (2) By part number
Input the part number in the text box
<Part Number Search>

2
Click a button on each tab of "Basic," "S-parameter," and "Detailed."

3
Click each purple button in this area. Click "CSV output" button.

* Images are as of October 2015. Be assured that this software will be updated frequently.

<http://www.murata.com/simsurfing/>

Index

A	
AWG	Low Temperature Co-fired Ceramics (LTCC) Multi-layer Module Boards 80
B	
B4F	Baluns 54
B5F	Baluns 54
BLA	Noise Suppression Filters (Chip Ferrite Bead) 28
BLE	Noise Suppression Filters (Chip Ferrite Bead) 29
BLL	Noise Suppression Filters (Lead Type) 34
BLM	Noise Suppression Filters (Chip Ferrite Bead) 28
BLO	Noise Suppression Filters (Lead Type) 34
BLT	Noise Suppression Filters (Chip Ferrite Bead) 29
BN	Noise Suppression Filters (Block Type) 32
BS	Magnetic Pattern Recognition Sensors 62
C	
CD	Ceramic Discriminators 50
CE	Isolators 54
CL	Single Layer Microchip Capacitors 57
CS	Ceramic Resonators CERALOCK® 47
D	
D5	Inductors (Coils) 39
D6	Inductors (Coils) 39
DE	Lead Type Ceramic Capacitors 21, 24
DEM	Inductors (Coils) 38
DF	Dielectric Filters GIGAFIL® 52
DFE	Inductors (Coils) 36
DG	Inductors (Coils) 39
DHK	High Voltage Ceramic Capacitors 26
DHR	Lead Type Ceramic Capacitors 21
DHS	High Voltage Ceramic Capacitors 26
DL	Noise Suppression Filters (Chip Common Mode Choke Coil) 31
DM	Supercapacitors (EDLC) 74
DS	Noise Suppression Filters (Lead Type) 34
DS1	Inductors (Coils) 39
DS7	Inductors (Coils) 39
DXP	Baluns 54
DXP	Couplers 55
DXW	Baluns 54
E	
EA	Microwave Absorbers 34
ECAS	Polymer Aluminum Electrolytic Capacitors 27
F	
FC	Inductors (Coils) 40
FD	Inductors (Coils) 40
FR	Rotary Sensors 62
FS	Ferrite Core 34
G	
GA	Chip Monolithic Ceramic Capacitors 7
GC	Chip Monolithic Ceramic Capacitors 15, 20
GJ	Chip Monolithic Ceramic Capacitors 8
GM	Chip Monolithic Ceramic Capacitors 8
GQ	Chip Monolithic Ceramic Capacitors 9
GR	Chip Monolithic Ceramic Capacitors 5, 9, 13
H	
HE	Inductors (Coils) 43
I	
IR	Pyroelectric Infrared Sensors 62
K	
KC	Chip Monolithic Ceramic Capacitors 19
KR	Chip Monolithic Ceramic Capacitors 11
L	
LDB	Baluns 54
LDC	Couplers 55
LDD	Chip Multilayer Hybrid Dividers 55
LDJ	Couplers 55
LDM	Baluns 54
LFB	Chip Multilayer LC Filters 52
LFC	Low Temperature Co-fired Ceramics (LTCC) Multi-layer Module Boards 80
LFD	Chip Multilayer Diplexers 55
LFL	Chip Multilayer LC Filters 52
LL	Chip Monolithic Ceramic Capacitors 12
LLB	Inductors (Coils) 40
LLM	Inductors (Coils) 40
LQ	Inductors (Coils) 36
LT	Proximity and Ambient Light Sensors 62
LXDC	Micro DC-DC Converters 71
LXES	ESD Protection Devices 33
LXMS	MAGICSTRAP® 83
LXRW	Variable Capacitors 78
LXTB	MAGICSTRAP® 83
M	
MA	Ultrasonic Sensors 62
MB	Inductors (Coils) 42
MHM	Ionizer Modules Ionissimo® 81
MHM	Ozonizer Modules Ionissimo® 82
MHR	High Voltage Resistors 44
MM	Microwave Coaxial Connectors (Receptacle) 56
MPD	DC-DC Converters 70
MPH	High Voltage Power Supplies 72
MPL	High Voltage Power Supplies 72
MR	AMR Sensors (Magnetic Sensors) 62
MSH	High Voltage Transformers 72
MX	Microwave Coaxial Connectors (Cable) 56
MY	DC-DC Converters 69
MZ	Microblowers 79
N	
NC	NTC Thermistors 62, 64
NF	Noise Suppression Filters (Feed Through Chip EMI Filters), (Chip LC Filters), (Chip EMIFIL®), (Chip Common Mode Noise Filters) 30, 31
NFM	Chip Monolithic Ceramic Capacitors 13, 19
NT	NTC Thermistors 66
NX	NTC Thermistors 62, 65
O	
OK	DC-DC Converters 70
P	
PKG	Shock Sensors 62
PKB	Piezoelectric Buzzers 77
PKL	Piezoelectric Sounders 76
PKM	Piezoelectric Sounders 76, 77
PLA	AC Line Filters 34
PLH	AC Line Filters 34
PLT	Noise Suppression Filters (Chip Common Mode Choke Coil) 32, 34
PLY	AC Line Filters 34
PR	PTC Thermistors POSISTOR® 62, 66, 68
PT	PTC Thermistors POSISTOR® 62, 67, 68
R	
RC	Lead Type Ceramic Capacitors 24
RD	Lead Type Ceramic Capacitors 22
RH	Lead Type Ceramic Capacitors 25
RU	Thin Film Circuit Substrate RUSUB® 59
S	
SA3	Coil Antennas 53
SAF	SAW Filters for Mobile Communications 51
SAW	SAW Filters for Mobile Communications 51
SAY	SAW Filters for Mobile Communications 51
SAZ	Coil Antennas 53
SCA	Accelerometers 62
SCA	Inclinometers 62
SCC	Gyro Sensors 62
SCR	Gyro Sensors 62
SF	Ceramic Filters CERAFIL® 49
STA	Coil Antennas 53
SV	Rotary Position Sensors 62
T	
TD	Dielectric Filters GIGAFIL® 52
TP	Ceramic Traps 50
TZ	Trimmer Capacitors 27
U	
UCMH	Noise Suppression Filters (Chip Common Mode Choke Coil) 32
UMAC	Small Energy Devices (Lithium Ion Batteries) 75
V	
VF	EMIGUARD® 34
X	
XD	Crystal Filters 51
XN	Crystal Oscillators 47
XR	Crystal Units 46
XT	Crystal Oscillators 47
Z	
ZPA	Barometric Pressure Sensors 62
7B	Piezoelectric Diaphragms 77

Global Locations

For details please visit www.murata.com



⚠ Note

1 Export Control

For customers outside Japan:

No Murata products should be used or sold, through any channels, for use in the design, development, production, utilization, maintenance or operation of, or otherwise contribution to (1) any weapons (Weapons of Mass Destruction [nuclear, chemical or biological weapons or missiles] or conventional weapons) or (2) goods or systems specially designed or intended for military end-use or utilization by military end-users.

For customers in Japan:

For products which are controlled items subject to the "Foreign Exchange and Foreign Trade Law" of Japan, the export license specified by the law is required for export.

2 Please contact our sales representatives or product engineers before using the products in this catalog for the applications listed below, which require especially high reliability for the prevention of defects which might directly damage a third party's life, body or property, or when one of our products is intended for use in applications other than those specified in this catalog.

- ① Aircraft equipment
- ② Aerospace equipment
- ③ Undersea equipment
- ④ Power plant equipment
- ⑤ Medical equipment
- ⑥ Transportation equipment (vehicles, trains, ships, etc.)
- ⑦ Traffic signal equipment
- ⑧ Disaster prevention / crime prevention equipment
- ⑨ Data-processing equipment
- ⑩ Application of similar complexity and/or reliability requirements to the applications listed above

3 Product specifications in this catalog are as of November 2016. They are subject to change or our products in it may be discontinued without advance notice. Please check with our sales representatives or product engineers before ordering. If there are any questions, please contact our sales representatives or product engineers.

4 Please read rating and ⚠CAUTION (for storage, operating, rating, soldering, mounting and handling) in this catalog to prevent smoking and/or burning, etc.

5 This catalog has only typical specifications. Therefore, please approve our product specifications or transact the approval sheet for product specifications before ordering.

6 Please note that unless otherwise specified, we shall assume no responsibility whatsoever for any conflict or dispute that may occur in connection with the effect of our and/or a third party's intellectual property rights and other related rights in consideration of your use of our products and/or information described or contained in our catalogs. In this connection, no representation shall be made to the effect that any third parties are authorized to use the rights mentioned above under licenses without our consent.

7 No ozone depleting substances (ODS) under the Montreal Protocol are used in our manufacturing process.

Murata Manufacturing Co., Ltd.

www.murata.com

muRata
INNOVATOR IN ELECTRONICS