

# RF Power Field Effect Transistor

## N-Channel Enhancement-Mode Lateral MOSFET

Designed for W-CDMA base station applications with frequencies from 1805 to 1880 MHz. Suitable for TDMA, CDMA and multicarrier amplifier applications. To be used in Class AB for PCN-PCS/cellular radio and WLL applications.

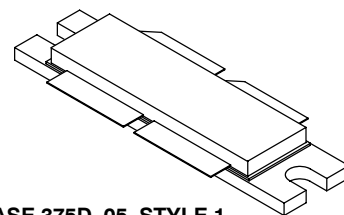
- Typical 2-Carrier W-CDMA Performance:  $V_{DD} = 28$  Volts,  $I_{DQ} = 2000$  mA,  $P_{out} = 44$  Watts Avg.,  $f = 1867.5$  MHz, Channel Bandwidth = 3.84 MHz, PAR = 8.5 dB @ 0.01% Probability on CCDF.
  - Power Gain — 15.9 dB
  - Drain Efficiency — 27.5%
  - IM3 @ 10 MHz Offset — -37 dBc in 3.84 MHz Channel Bandwidth
  - ACPR @ 5 MHz Offset — -41 dBc in 3.84 MHz Channel Bandwidth
- Capable of Handling 10:1 VSWR, @ 28 Vdc, 1840 MHz, 190 Watts CW Output Power

### Features

- Characterized with Series Equivalent Large-Signal Impedance Parameters
- Internally Matched for Ease of Use
- Qualified Up to a Maximum of 32  $V_{DD}$  Operation
- Integrated ESD Protection
- Designed for Lower Memory Effects and Wide Instantaneous Bandwidth Applications
- RoHS Compliant
- In Tape and Reel. R6 Suffix = 150 Units, 56 mm Tape Width, 13 inch Reel.

**MRF6P18190HR6**

**1805-1880 MHz, 44 W AVG., 28 V  
 2 x W-CDMA  
 LATERAL N-CHANNEL  
 RF POWER MOSFET**



**CASE 375D-05, STYLE 1  
 NI-1230**

**Table 1. Maximum Ratings**

Rating	Symbol	Value	Unit
Drain-Source Voltage	$V_{DSS}$	-0.5, +68	Vdc
Gate-Source Voltage	$V_{GS}$	-0.5, +12	Vdc
Storage Temperature Range	$T_{stg}$	- 65 to +150	°C
Case Operating Temperature	$T_C$	150	°C
Operating Junction Temperature (1,2)	$T_J$	225	°C

**Table 2. Thermal Characteristics**

Characteristic	Symbol	Value (2,3)	Unit
Thermal Resistance, Junction to Case	$R_{\theta JC}$		°C/W
Case Temperature 80°C, 190 W CW		0.27	
Case Temperature 76°C, 44 W CW		0.30	

1. Continuous use at maximum temperature will affect MTTF.
2. MTTF calculator available at <http://www.freescale.com/rf>. Select Software & Tools/Development Tools/Calculators to access MTTF calculators by product.
3. Refer to AN1955, *Thermal Measurement Methodology of RF Power Amplifiers*. Go to <http://www.freescale.com/rf>. Select Documentation/Application Notes - AN1955.

LIFETIME BUY

LAST SHIP 30 JUN 12  
 LAST ORDER 1 JUL 11

**Table 3. ESD Protection Characteristics**

Test Methodology	Class
Human Body Model (per JESD22-A114)	1C (Minimum)
Machine Model (per EIA/JESD22-A115)	A (Minimum)
Charge Device Model (per JESD22-C101)	III (Minimum)

**Table 4. Electrical Characteristics** ( $T_A = 25^\circ\text{C}$  unless otherwise noted)

Characteristic	Symbol	Min	Typ	Max	Unit
<b>Off Characteristics</b> <sup>(1)</sup>					
Zero Gate Voltage Drain Leakage Current ( $V_{DS} = 68\text{ Vdc}$ , $V_{GS} = 0\text{ Vdc}$ )	$I_{DSS}$	—	—	10	$\mu\text{Adc}$
Zero Gate Voltage Drain Leakage Current ( $V_{DS} = 28\text{ Vdc}$ , $V_{GS} = 0\text{ Vdc}$ )	$I_{DSS}$	—	—	1	$\mu\text{Adc}$
Gate-Source Leakage Current ( $V_{GS} = 5\text{ Vdc}$ , $V_{DS} = 0\text{ Vdc}$ )	$I_{GSS}$	—	—	1	$\mu\text{Adc}$

**On Characteristics**

Gate Threshold Voltage <sup>(1)</sup> ( $V_{DS} = 10\text{ Vdc}$ , $I_D = 250\ \mu\text{Adc}$ )	$V_{GS(th)}$	1	2	3	Vdc
Gate Quiescent Voltage <sup>(3)</sup> ( $V_{DD} = 28\text{ Vdc}$ , $I_D = 2000\text{ mAdc}$ , Measured in Functional Test)	$V_{GS(Q)}$	2	2.8	4	Vdc
Drain-Source On-Voltage <sup>(1)</sup> ( $V_{GS} = 10\text{ Vdc}$ , $I_D = 2.2\text{ Adc}$ )	$V_{DS(on)}$	—	0.21	—	Vdc

**Dynamic Characteristics** <sup>(2,3)</sup>

Reverse Transfer Capacitance ( $V_{DS} = 28\text{ Vdc} \pm 30\text{ mV(rms)ac}$ @ 1 MHz, $V_{GS} = 0\text{ Vdc}$ )	$C_{rss}$	—	1.5	—	pF
---	-----------	---	-----	---	----

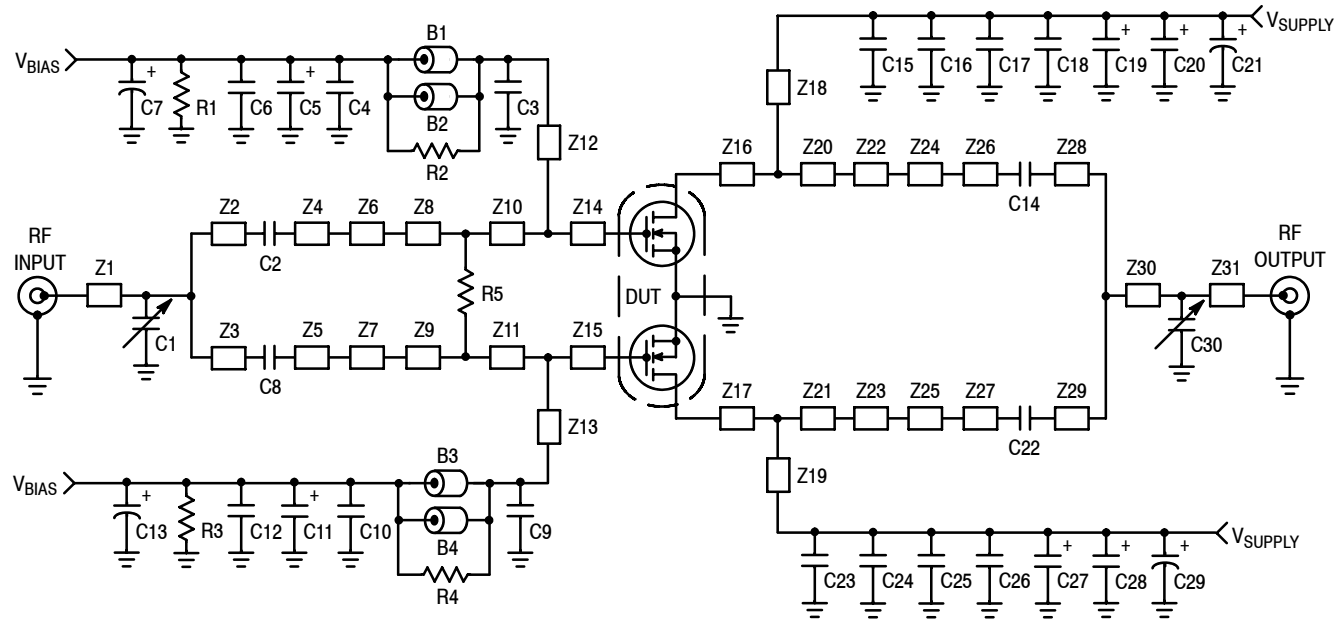
**Functional Tests** <sup>(3)</sup> (In Freescale Test Fixture, 50 ohm system)  $V_{DD} = 28\text{ Vdc}$ ,  $I_{DQ} = 2000\text{ mA}$ ,  $P_{out} = 44\text{ W Avg.}$ ,  $f_1 = 1867.5\text{ MHz}$ ,  $f_2 = 1877.5\text{ MHz}$ , 2-Carrier W-CDMA, 3.84 MHz Channel Bandwidth Carriers. ACPR measured in 3.84 MHz Channel Bandwidth @  $\pm 5\text{ MHz}$  Offset. IM3 measured in 3.84 MHz Bandwidth @  $\pm 10\text{ MHz}$  Offset. PAR = 8.5 dB @ 0.01% Probability on CCDF.

Power Gain	$G_{ps}$	14.5	15.9	17.5	dB
Drain Efficiency	$\eta_D$	25.5	27.5	—	%
Intermodulation Distortion	IM3	—	-37	-35	dBc
Adjacent Channel Power Ratio	ACPR	—	-41	-38	dBc
Input Return Loss	IRL	—	-12	-9	dB

1. Each side of device measured separately.
2. Part internally matched both on input and output.
3. Measurement made with device in push-pull configuration.

LIFETIME BUY

LAST ORDER 1 JUL 11 LAST SHIP 30 JUN 12



Z1	0.700" x 0.067" Microstrip	Z18, Z19	0.477" x 0.136" Microstrip
Z2	1.140" x 0.114" Microstrip	Z20, Z21	0.289" x 0.856" Microstrip
Z3	2.112" x 0.067" Microstrip	Z22, Z23	0.215" x 0.385" Microstrip
Z4, Z5	0.174" x 0.067" Microstrip	Z24, Z25	0.118" x 0.259" Microstrip
Z6, Z7	0.382" x 0.250" Microstrip	Z26, Z27	0.108" x 0.067" Microstrip
Z8, Z9	0.036" x 0.764" Microstrip	Z28	2.163" x 0.067" Microstrip
Z10, Z11	0.178" x 0.764" Microstrip	Z29	1.397" x 0.114" Microstrip
Z12, Z13	0.689" x 0.073" Microstrip	Z30	0.492" x 0.067" Microstrip
Z14, Z15	0.111" x 0.764" Microstrip	Z31	0.207" x 0.067" Microstrip
Z16, Z17	0.124" x 0.856" Microstrip	PCB	Taconic RF-35, 0.030", $\epsilon_r = 3.5$

**Figure 1. MRF6P18190H Test Circuit Schematic**
**Table 5. MRF6P18190H Test Circuit Component Designations and Values**

Part	Description	Part Number	Manufacturer
B1, B2, B3, B4	Short RF Beads	2743019447	Fair-Rite
C1	0.6–4.5 pF Variable Capacitor	27271SL	Johanson Components
C2, C8, C14, C22	5.6 pF Chip Capacitors	ATC100B5R6CT500XT	ATC
C3, C9	7.5 pF Chip Capacitors	ATC100B7R5CT500XT	ATC
C4, C10, C18, C26	1K pF Chip Capacitors	ATC100B102JT50XT	ATC
C5, C11	1 $\mu$ F, 50 V Tantalum Capacitors	T491C105K050AT	Kemet
C6, C12, C17, C25	0.1 $\mu$ F Chip Capacitors	CDR33BX104AKTS	Kemet
C7, C13	100 $\mu$ F, 50 V Electrolytic Capacitors, Radial	EEEFK1H101P	Panasonic
C15, C23	6.8 pF Chip Capacitors	ATC100B6R8GT500XT	ATC
C16, C24	0.56 $\mu$ F Chip Capacitors	C1825C564J5RAC	Kemet
C19, C20, C27, C28	22 $\mu$ F, 35 V Tantalum Capacitors	T491X226K035AT	Kemet
C21, C29	470 $\mu$ F, 63 V Electrolytic Capacitors, Radial	477KXM063M	Illinois Capacitor
C30	0.4–2.5 pF Variable Capacitor	27283PC	Johanson Components
R1, R3	1 k $\Omega$ , 1/4 W Chip Resistors	CRCW12061001FKEA	Vishay
R2, R4	12 $\Omega$ , 1/4 W Chip Resistors	CRCW120612R0FKEA	Vishay
R5	560 $\Omega$ , 1/4 W Chip Resistor	CRCW12065600FKEA	Vishay

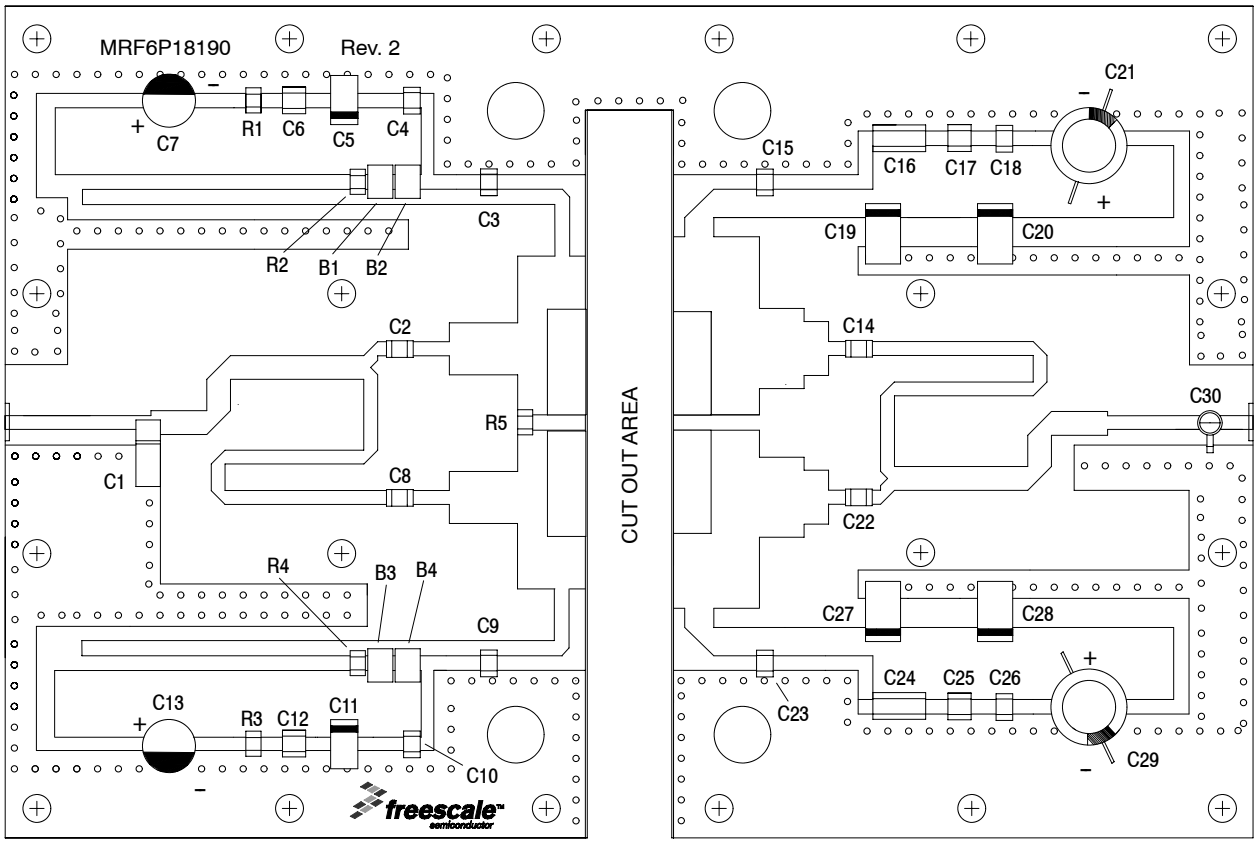


Figure 2. MRF6P18190H Test Circuit Component Layout

LAST ORDER 1 JUL 11 LAST SHIP 30 JUN 12

### TYPICAL CHARACTERISTICS

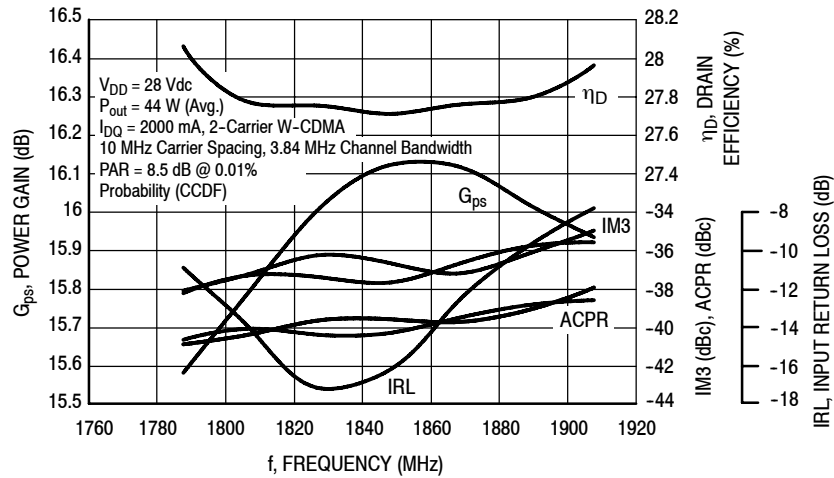


Figure 3. 2-Carrier W-CDMA Broadband Performance @  $P_{out} = 44$  Watts

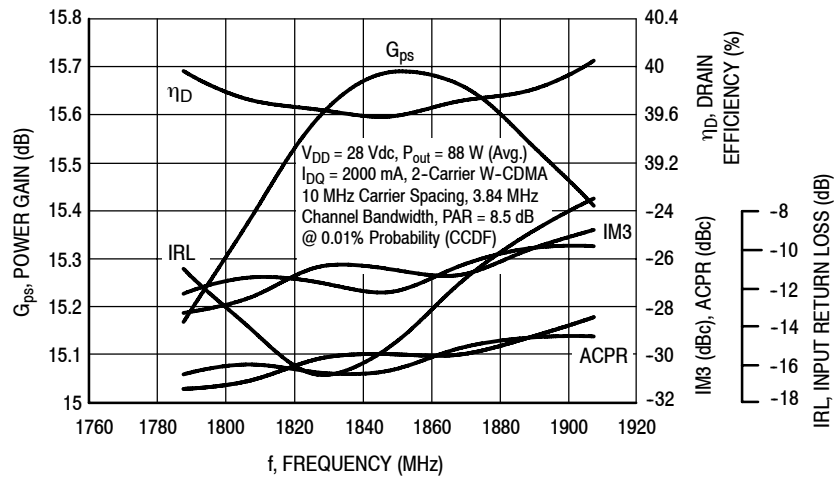


Figure 4. 2-Carrier W-CDMA Broadband Performance @  $P_{out} = 88$  Watts

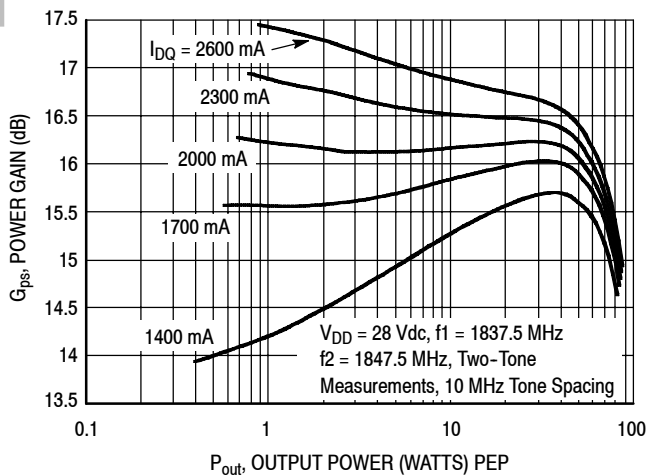


Figure 5. Two-Tone Power Gain versus Output Power

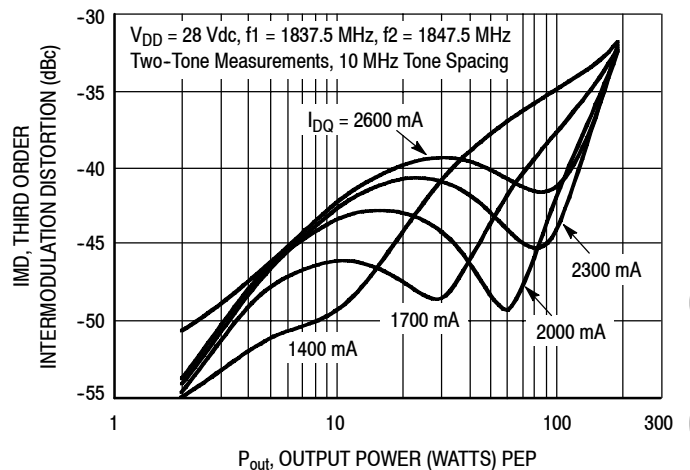
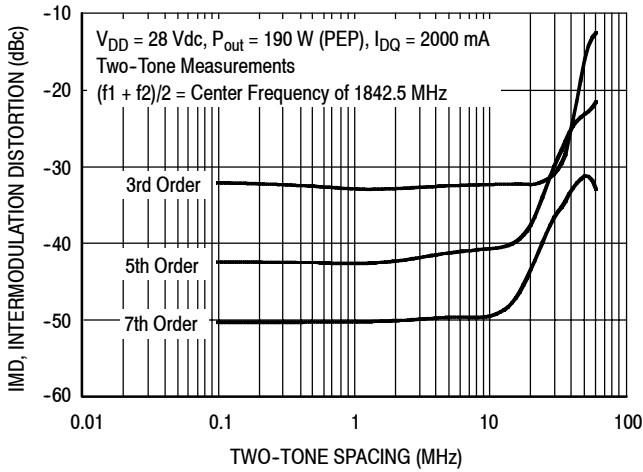


Figure 6. Third Order Intermodulation Distortion versus Output Power

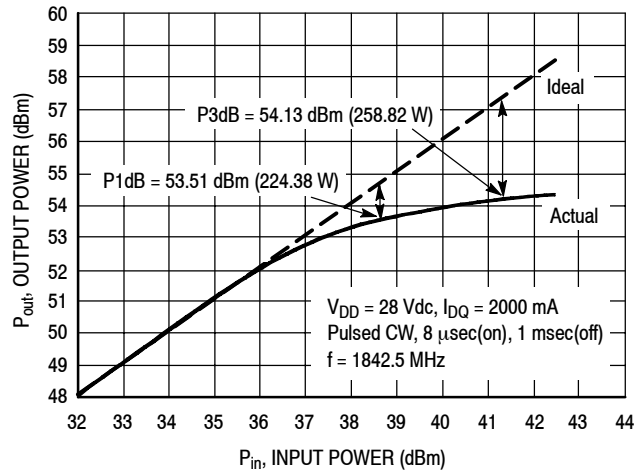
LIFETIME BUY

LAST ORDER 1 JUL 11 LAST SHIP 30 JUN 12

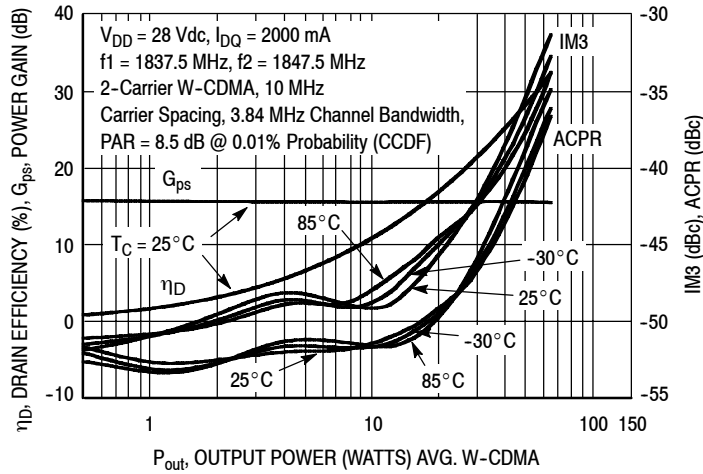
### TYPICAL CHARACTERISTICS



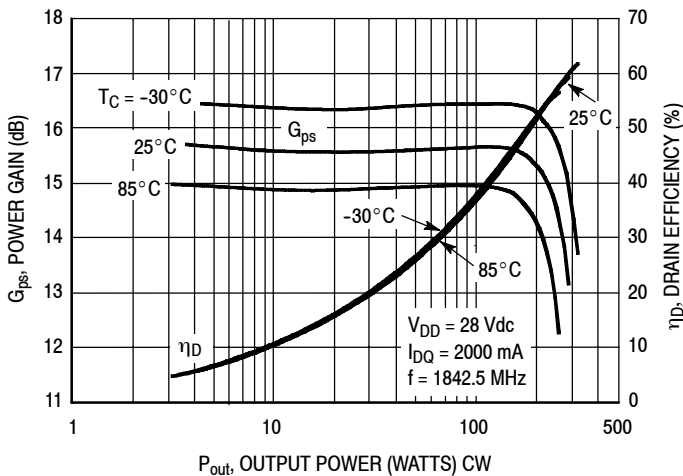
**Figure 7. Intermodulation Distortion Products versus Tone Spacing**



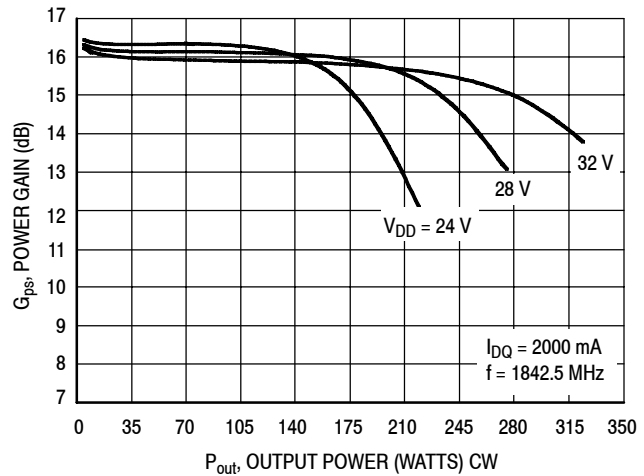
**Figure 8. Pulsed CW Output Power versus Input Power**



**Figure 9. 2-Carrier W-CDMA ACPR, IM3, Power Gain and Drain Efficiency versus Output Power**



**Figure 10. Power Gain and Drain Efficiency versus CW Output Power**

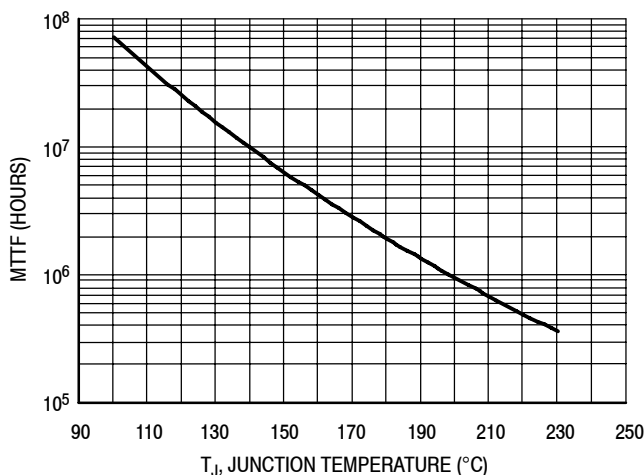


**Figure 11. Power Gain versus Output Power**

LIFETIME BUY

LAST ORDER 1 JUL 11 LAST SHIP 30 JUN 12

### TYPICAL CHARACTERISTICS



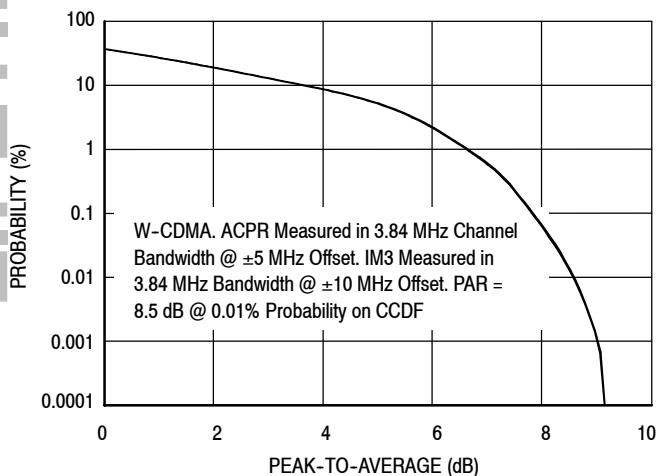
This above graph displays calculated MTTF in hours when the device is operated at  $V_{DD} = 28$  Vdc,  $P_{out} = 44$  W Avg., and  $\eta_D = 27.5\%$ .

MTTF calculator available at <http://www.freescale.com/rf>. Select Software & Tools/Development Tools/Calculators to access MTTF calculators by product.

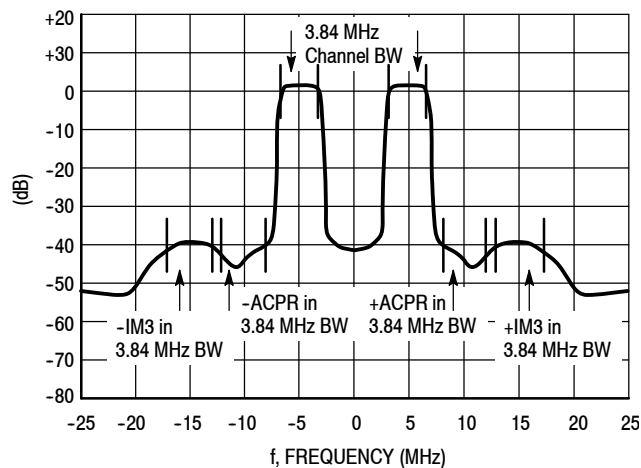
**Figure 12. MTTF versus Junction Temperature**

LIFETIME BUY

### W-CDMA TEST SIGNAL

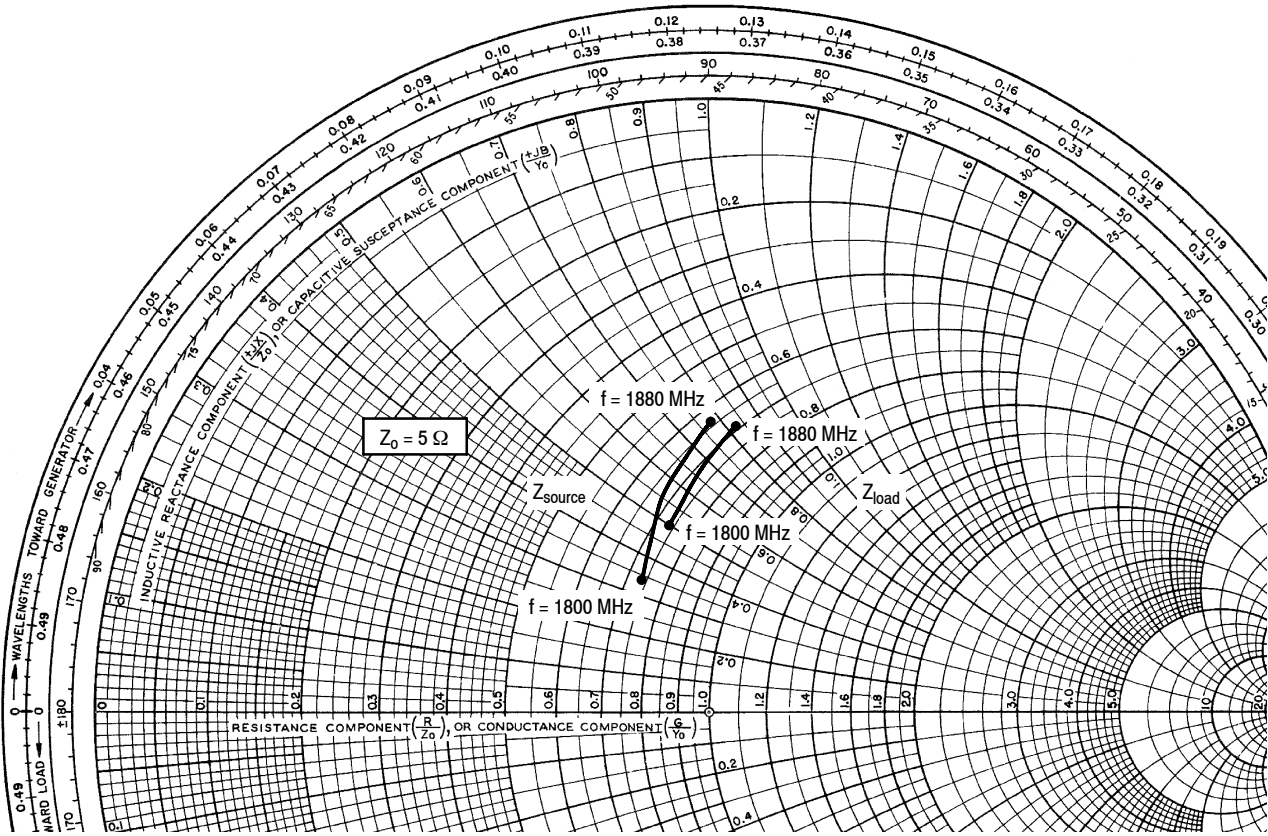


**Figure 13. CCDF W-CDMA 3GPP, Test Model 1, 64 DPCH, 67% Clipping, Single-Carrier Test Signal**



**Figure 14. 2-Carrier W-CDMA Spectrum**

LAST ORDER 1 JUL 11 LAST SHIP 30 JUN 12



$V_{DD} = 28 \text{ Vdc}$ ,  $I_{DQ} = 2000 \text{ mA}$ ,  $P_{out} = 44 \text{ W Avg.}$

f MHz	$Z_{source}$ $\Omega$	$Z_{load}$ $\Omega$
1800	$3.70 + j1.71$	$3.70 + j2.49$
1840	$3.40 + j2.75$	$3.55 + j3.29$
1880	$3.19 + j3.88$	$3.45 + j4.12$

$Z_{source}$  = Test circuit impedance as measured from gate to gate.

$Z_{load}$  = Test circuit impedance as measured from drain to drain.

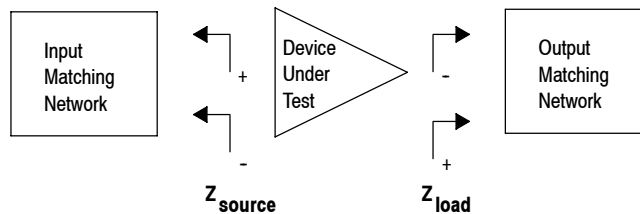
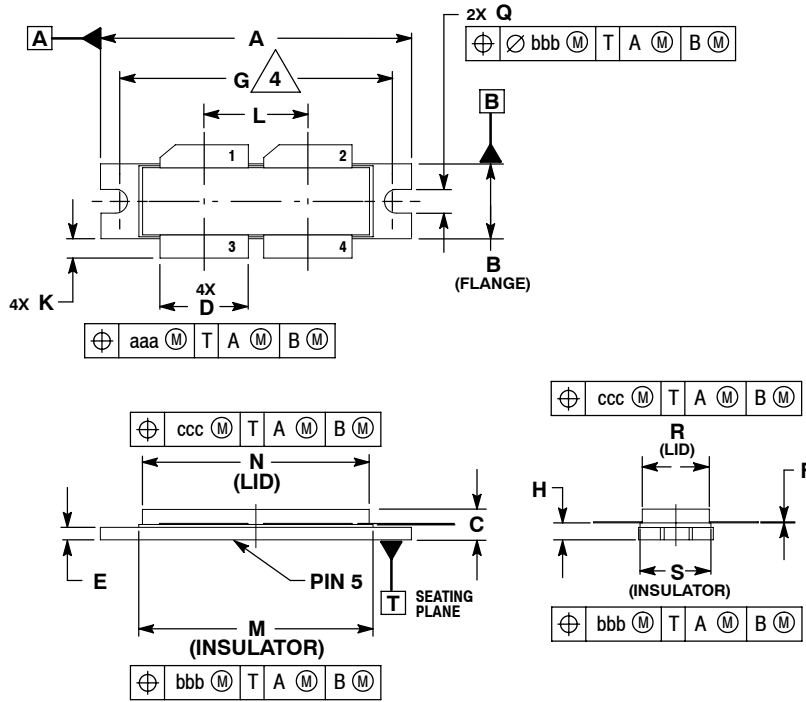


Figure 15. Series Equivalent Source and Load Impedance



## PACKAGE DIMENSIONS



### NOTES:

1. INTERPRET DIMENSIONS AND TOLERANCES PER ASME Y14.5M-1994.
2. CONTROLLING DIMENSION: INCH.
3. DIMENSION H IS MEASURED 0.030 (0.762) AWAY FROM PACKAGE BODY.
4. RECOMMENDED BOLT CENTER DIMENSION OF 1.52 (38.61) BASED ON M3 SCREW.

DIM	INCHES		MILLIMETERS	
	MIN	MAX	MIN	MAX
A	1.615	1.625	41.02	41.28
B	0.395	0.405	10.03	10.29
C	0.150	0.200	3.81	5.08
D	0.455	0.465	11.56	11.81
E	0.062	0.066	1.57	1.68
F	0.004	0.007	0.10	0.18
G	1.400 BSC		35.56 BSC	
H	0.082	0.090	2.08	2.29
K	0.117	0.137	2.97	3.48
L	0.540 BSC		13.72 BSC	
M	1.219	1.241	30.96	31.52
N	1.218	1.242	30.94	31.55
O	0.120	0.130	3.05	3.30
R	0.355	0.365	9.01	9.27
S	0.365	0.375	9.27	9.53
aaa	0.013 REF		0.33 REF	
bbb	0.010 REF		0.25 REF	
ccc	0.020 REF		0.51 REF	

### STYLE 1:

1. DRAIN
2. DRAIN
3. GATE
4. GATE
5. SOURCE

**CASE 375D-05  
ISSUE E  
NI-1230**

## PRODUCT DOCUMENTATION

Refer to the following documents to aid your design process.

### Application Notes

- AN1955: Thermal Measurement Methodology of RF Power Amplifiers

### Engineering Bulletins

- EB212: Using Data Sheet Impedances for RF LDMOS Devices

## REVISION HISTORY

The following table summarizes revisions to this document.

Revision	Date	Description
2	Dec. 2008	<ul style="list-style-type: none"> <li>• Modified data sheet to reflect RF Test Reduction described in Product and Process Change Notification number, PCN13232, p. 1, 2</li> <li>• Removed Lower Thermal Resistance and Low Gold Plating bullets from Features section as functionality is standard, p. 1</li> <li>• Removed Total Device Dissipation from Max Ratings table as data was redundant (information already provided in Thermal Characteristics table), p. 1</li> <li>• Operating Junction Temperature increased from 200° to 225°C in Maximum Ratings table and related “Continuous use of maximum temperature will affect MTTF” footnote added, p. 1</li> <li>• Corrected <math>V_{DS}</math> to <math>V_{DD}</math> in the RF test condition voltage callout for <math>V_{GS(Q)}</math>, On Characteristics table, p. 2</li> <li>• Removed Forward Transconductance from On Characteristics table as it no longer provided usable information, p. 2</li> <li>• Updated Part Numbers in Table 5, Component Designations and Values, to latest RoHS compliant part numbers, p. 3</li> <li>• Removed lower voltage test from Fig. 11, Power Gain versus Output Power, due to fixed tuned fixture limitations, p. 6</li> <li>• Replaced Fig. 12, MTTF versus Junction Temperature with updated graph. Removed Amps<sup>2</sup> and listed operating characteristics and location of MTTF calculator for device, p. 7</li> <li>• Updated <math>Z_{source}</math> and <math>Z_{load}</math> definitions, Fig. 15, Series Equivalent Source and Load Impedance, p. 8</li> <li>• Added Product Documentation and Revision History, p. 10</li> </ul>
3	Dec. 2010	<ul style="list-style-type: none"> <li>• Corrected data sheet to reflect RF Test Reduction described in Product and Process Change Notification number, PCN13232, and Product Discontinuance Notification number, PCN14260, adding applicable overlay, p. 1, 2</li> </ul>

LIFETIME BUY

LAST ORDER 1 JUL 11 LAST SHIP 30 JUN 12

## **How to Reach Us:**

### **Home Page:**

[www.freescale.com](http://www.freescale.com)

### **Web Support:**

<http://www.freescale.com/support>

### **USA/Europe or Locations Not Listed:**

Freescale Semiconductor, Inc.  
Technical Information Center, EL516  
2100 East Elliot Road  
Tempe, Arizona 85284  
1-800-521-6274 or +1-480-768-2130  
[www.freescale.com/support](http://www.freescale.com/support)

### **Europe, Middle East, and Africa:**

Freescale Halbleiter Deutschland GmbH  
Technical Information Center  
Schatzbogen 7  
81829 Muenchen, Germany  
+44 1296 380 456 (English)  
+46 8 52200080 (English)  
+49 89 92103 559 (German)  
+33 1 69 35 48 48 (French)  
[www.freescale.com/support](http://www.freescale.com/support)

### **Japan:**

Freescale Semiconductor Japan Ltd.  
Headquarters  
ARCO Tower 15F  
1-8-1, Shimo-Meguro, Meguro-ku,  
Tokyo 153-0064  
Japan  
0120 191014 or +81 3 5437 9125  
[support.japan@freescale.com](mailto:support.japan@freescale.com)

### **Asia/Pacific:**

Freescale Semiconductor China Ltd.  
Exchange Building 23F  
No. 118 Jianguo Road  
Chaoyang District  
Beijing 100022  
China  
+86 10 5879 8000  
[support.asia@freescale.com](mailto:support.asia@freescale.com)

### **For Literature Requests Only:**

Freescale Semiconductor Literature Distribution Center  
1-800-441-2447 or +1-303-675-2140  
Fax: +1-303-675-2150  
[LDCForFreescaleSemiconductor@hibbertgroup.com](mailto:LDCForFreescaleSemiconductor@hibbertgroup.com)

Information in this document is provided solely to enable system and software implementers to use Freescale Semiconductor products. There are no express or implied copyright licenses granted hereunder to design or fabricate any integrated circuits or integrated circuits based on the information in this document.

Freescale Semiconductor reserves the right to make changes without further notice to any products herein. Freescale Semiconductor makes no warranty, representation or guarantee regarding the suitability of its products for any particular purpose, nor does Freescale Semiconductor assume any liability arising out of the application or use of any product or circuit, and specifically disclaims any and all liability, including without limitation consequential or incidental damages. "Typical" parameters that may be provided in Freescale Semiconductor data sheets and/or specifications can and do vary in different applications and actual performance may vary over time. All operating parameters, including "Typicals", must be validated for each customer application by customer's technical experts. Freescale Semiconductor does not convey any license under its patent rights nor the rights of others. Freescale Semiconductor products are not designed, intended, or authorized for use as components in systems intended for surgical implant into the body, or other applications intended to support or sustain life, or for any other application in which the failure of the Freescale Semiconductor product could create a situation where personal injury or death may occur. Should Buyer purchase or use Freescale Semiconductor products for any such unintended or unauthorized application, Buyer shall indemnify and hold Freescale Semiconductor and its officers, employees, subsidiaries, affiliates, and distributors harmless against all claims, costs, damages, and expenses, and reasonable attorney fees arising out of, directly or indirectly, any claim of personal injury or death associated with such unintended or unauthorized use, even if such claim alleges that Freescale Semiconductor was negligent regarding the design or manufacture of the part.

Freescale™ and the Freescale logo are trademarks of Freescale Semiconductor, Inc. All other product or service names are the property of their respective owners.

© Freescale Semiconductor, Inc. 2005-2006, 2008, 2010. All rights reserved.