

SPECIFICATION

- Part No. : **GA.107.201111**
- Product Name : Magnetic Mount Cellular Penta-band Antenna
- Feature : Delivers high performance for all 2G/3G/3.5 networks worldwide
800MHz to 2200MHz
Magnetic mount
Superior Super Magnet – Neodymium N35
Custom cables and connectors available
RoHS Compliant



1. Introduction

The GA.107 magnetic cellular band antenna delivers marked improvements in efficiency and gain across all common frequencies in use for cellular bands today. Now one antenna can be used in place of multiple part numbers.

Small enough to be used indoors and outdoors, the antenna performance has been designed to take advantage of any metal plate (ground-plane) it attaches to deliver best of class performance.

The GA.107 features a superior super magnet made from Neodymium N35, giving the antenna a maximum pull-force of 1.92 kilogram-force (kgf).

A reliable return loss of <10dB when mounted on a metal plate ensures it complies with the industry standards set by module makers and networks worldwide.

2. Specification

PENTA-BAND CELLULAR					
Communication System	AMPS	GSM	DCS	PCS	UMTS
Frequency (MHz)	824 ~ 896	880 ~ 960	1710~1880	1850 ~ 1990	1710 ~ 2170
Peak Gain (dBi)					
Free Space	2.6	5.0	-2.2	-2.3	-2.1
With metal Ground	0.1	-0.3	-1.0	-1.0	-0.7
Efficiency					
Free Space	35%	45%	21%	22%	22%
With metal Ground	44%	40%	24%	26%	26%
Impedance	50Ω				
Polarization	Linear				
Radiation Pattern	Omni-directional				
V.S.W.R.	< 2.0 : 1				
Input Power	50 W				
MECHANICAL					
Dimensions	Length 116mm,Φ29.5mm Base				
Cable type	RG-174				
Cable Length	2M				
Pull Force	1.92 kgf Max.				
Casing	300 series stainless steel with black Duracoat finish				
Connector	SMA Male				
ENVIRONMENTAL					
Temperature Range	-40°C to 85°C				
Humidity	Non-condensing 65°C 95% RH				

*Note – RF characteristic shown in this data sheet is measured with RG-174 and SMA(M) connector in room temperature.

3. Antenna Characteristics

3.1 Return Loss

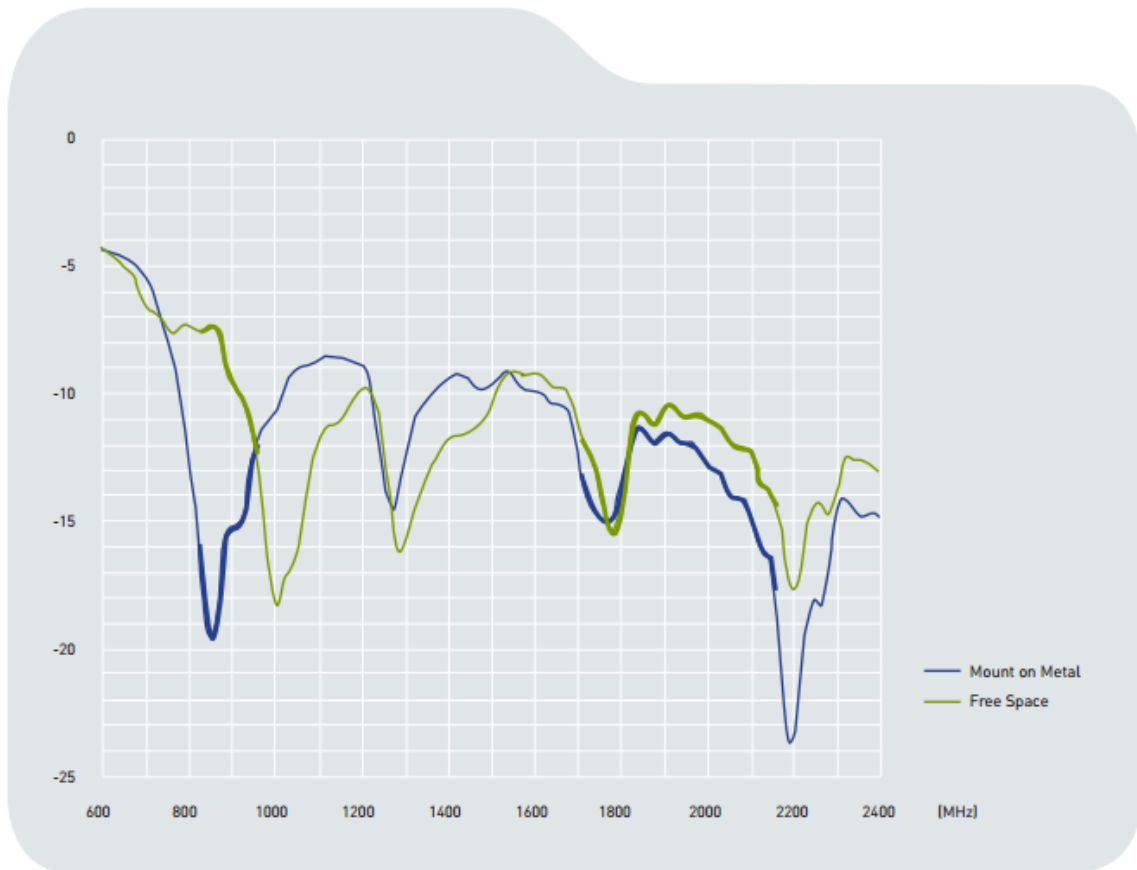

The highlighted parts are cellular operation frequency.

3.2 Antenna Efficiency



4. Antenna Radiation Patterns

4.1 Radiation Pattern (Free Space)

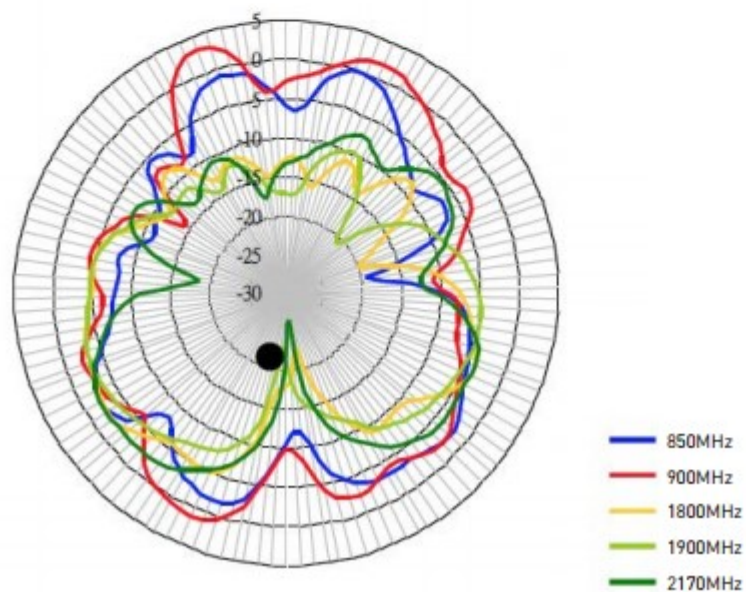
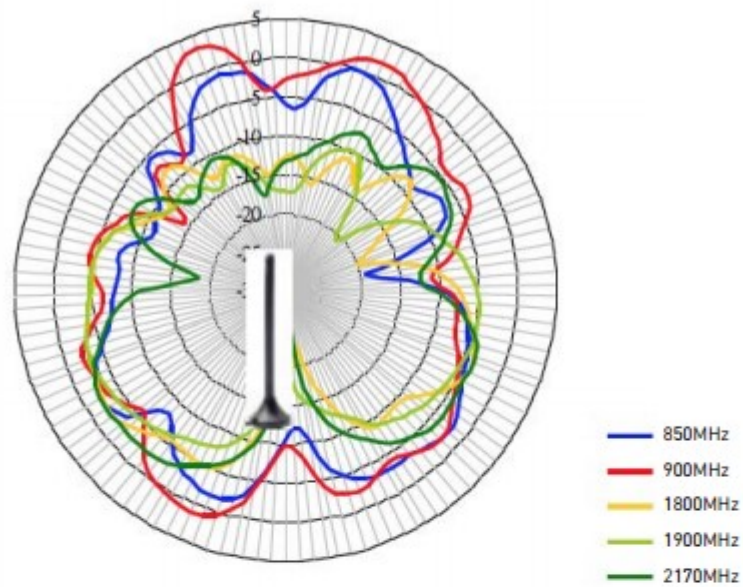

4.2 Radiation Pattern (on Ground Plane)

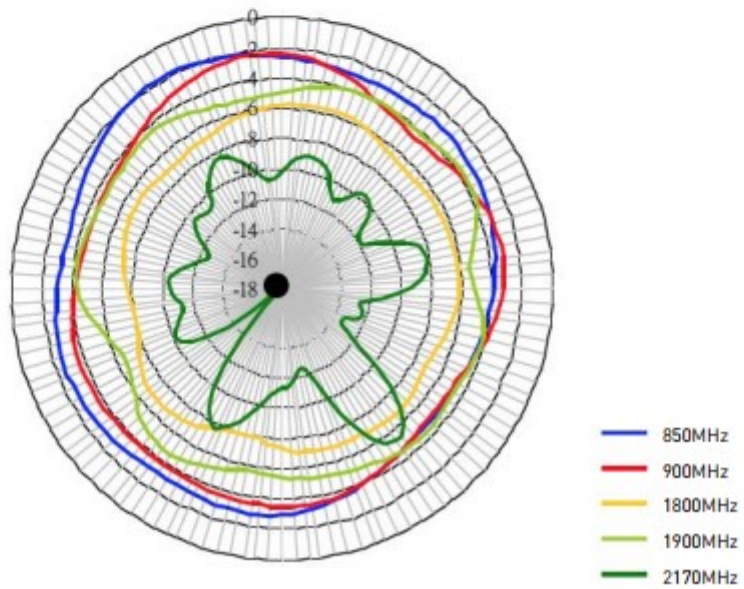
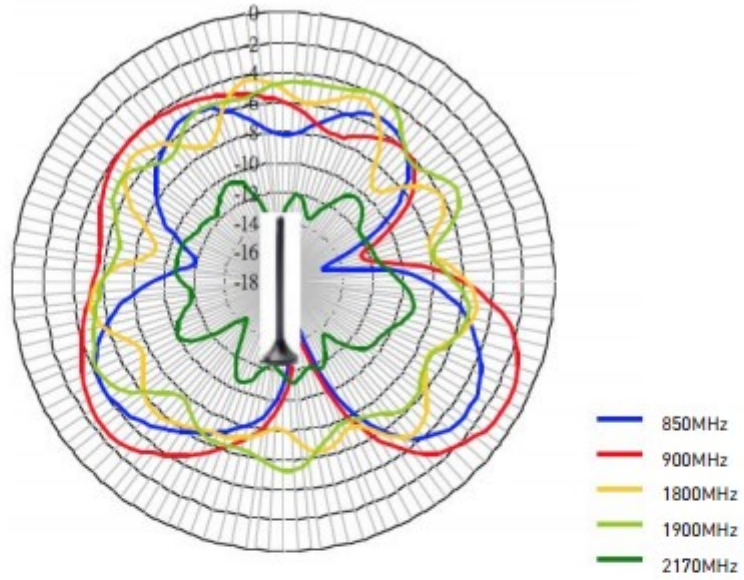

5. Magnetic Pull Force (kilogram-force (kgf))

Distance (mm)	0	0.1	0.2	0.3	0.4	0.5	0.6	0.7	0.8	0.9	1
Pull force (kgf)	0	1.37	1.61	1.85	1.9	1.92	1.64	1.42	1.28	1.15	1.06
Distance (mm)	1.1	1.2	1.3	1.4	1.5	1.6	1.7	1.8	1.9	2	2.1
Pull force (kgf)	0.98	0.92	0.86	0.82	0.76	0.74	0.7	0.68	0.64	0.62	0.6
Distance (mm)	2.2	2.3	2.4	2.5	2.6	2.7	2.8	2.9	3	3.1	3.2
Pull force (kgf)	0.58	0.56	0.54	0.52	0.52	0.5	0.49	0.47	0.46	0.45	0.44
Distance (mm)	3.3	3.4	3.5	3.6	3.7	3.8	3.9	4	4.1	4.2	4.3
Pull force (kgf)	0.44	0.42	0.42	0.42	0.4	0.4	0.4	0.38	0.36	0.36	0.36
Distance (mm)	4.4	4.5	4.6	4.7	4.8	4.9	5				
Pull force (kgf)	0.36	0.36	0.36	0.34	0.35	0.34	0.34				

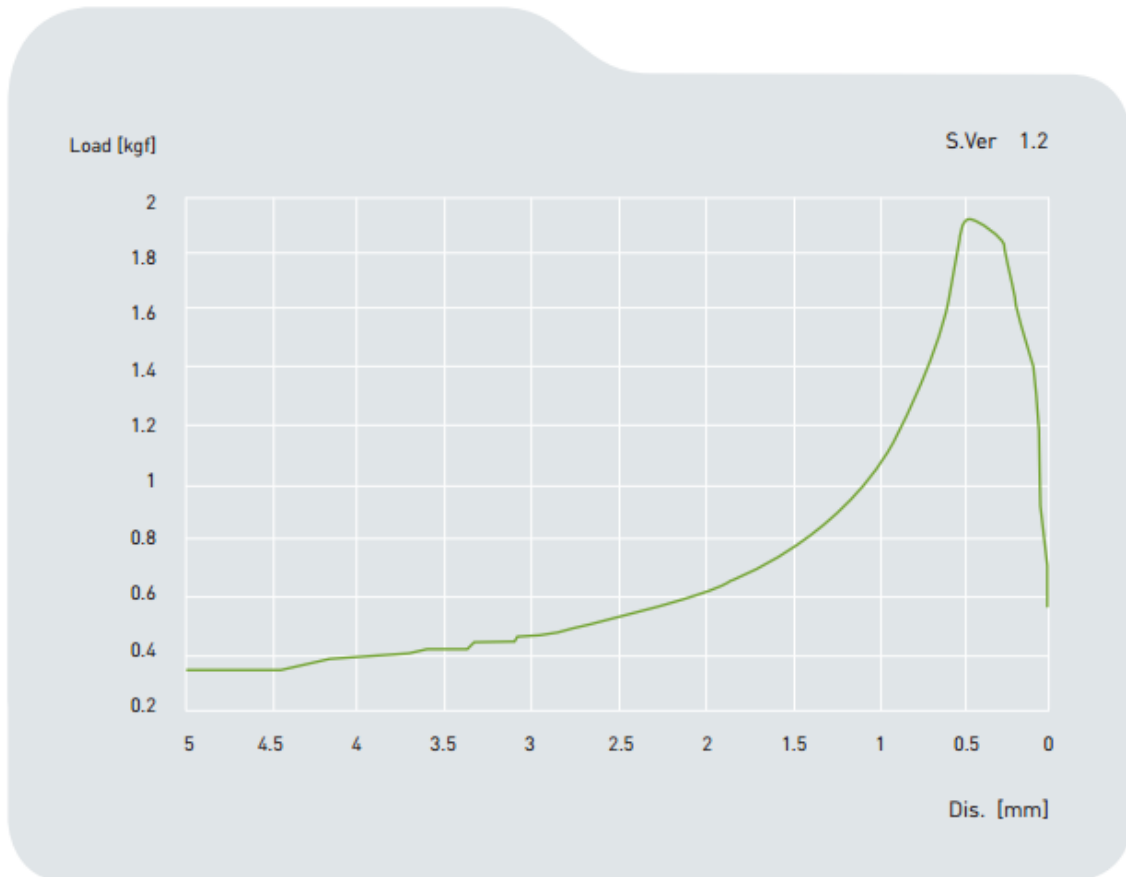

6. Drawing

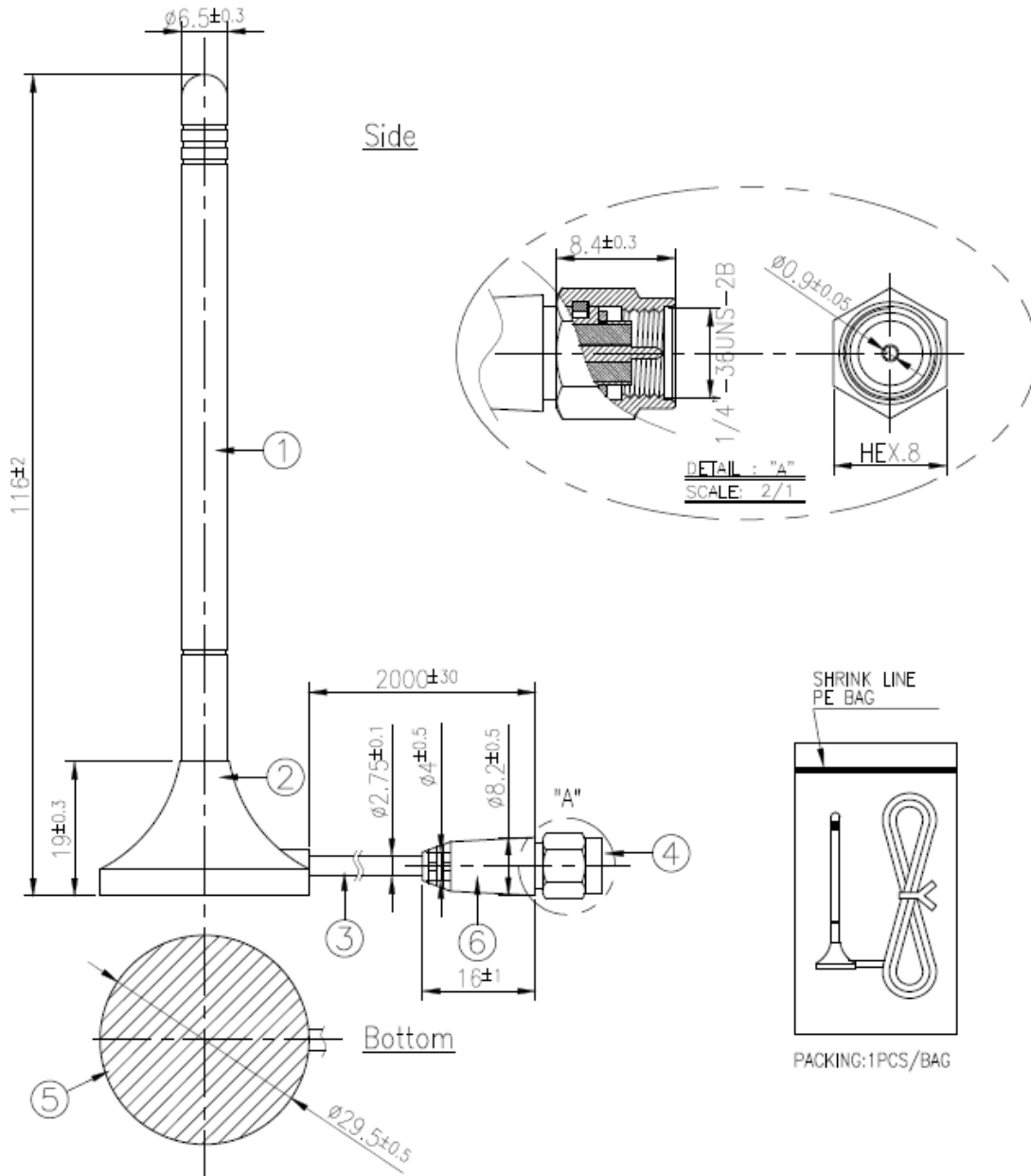

NOTE:
1. Sticker Area. 

	Name	P/N	Material	Finish	QTY
1	GA.107 Antenna Housing	000111J040002A	TPU	Black	1
2	Holder	000111J050002A	ABS	Black	1
3	RG174 Coaxial Cable	301315C000000A	PVC	Black	1
4	SMA(M)	200211J000002A	Brass	Au Plated	1
5	Sticker	001011J130002A	Polyster	Silver	1
	Strain Rel			Black	1

7. Packaging

