

# 3mm (T1) Package Discrete LED RED, Extended Profile

# BIVAR

## 3HX-201-X

- ◆ Industry Standard 3mm (T1) Package
- ◆ RoHS Compliant
- ◆ Water Clear (C), Diffused (D), and Tinted (T) Lenses
- ◆ Available in Shouldered (S) Lead Frame Style
- ◆ Ideal for Status Indication and Display



Bivar 3mm T1 Package Extended Profile LED may be used in almost any application and provides additional protrusion for those applications with thicker face plates. Bivar offers water clear LED lens for maximum light output, diffused LED lens for uniform light output, and tinted lens to identify the color of the LED. The Shouldered Lead frame LED is ideal for vertical spacer assemblies without lead bends and also has a built in strain relief feature which is ideal for right angle holder assemblies that require lead bends.

Part Number	Material	Emitted Color	Peak. Wavelength $\lambda_p$ (nm) TYP.	Lens Appearance	Viewing Angle
3HC-201-S	GaAsP/GaP	RED	625nm	Water Clear	20°
3HD-201-S				Red Diffused	35°
3HT-201-S				Red Tinted	20°

## Part Number Designation

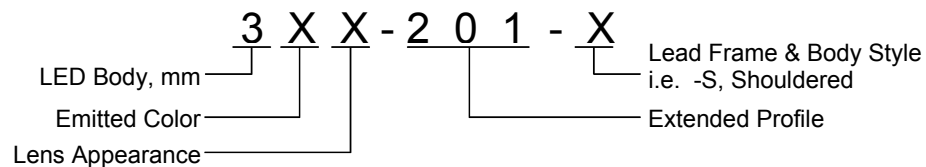

Bivar reserves the right to make changes at any time without notice.

# 3mm (T1) Package Discrete LED RED, Extended Profile



## Outline Dimensions

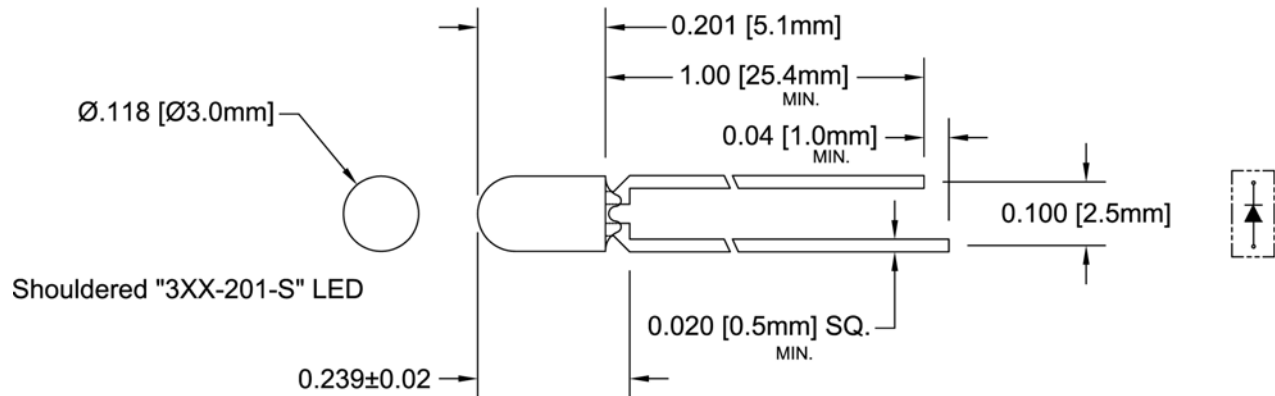

### Recommended Mounting

Hole Size =  $\text{Ø}0.032^{+0.003}_{-.002}$

#### Outline Drawings Notes:

1. All dimensions are in inches [millimeters].
2. Standard tolerance:  $\pm 0.010$ " unless otherwise noted.
3. Tolerance of overall epoxy outline:  $\pm 0.020$ " unless otherwise noted.
4. Epoxy meniscus may extend to 0.060" max.

Bivar reserves the right to make changes at any time without notice.

# 3mm (T1) Package Discrete LED RED, Extended Profile



## Absolute Maximum Ratings

T<sub>A</sub> = 25°C unless otherwise noted

Power Dissipation	80 mW
Forward Current ( DC )	30 mA
Peak Forward Current <sup>1</sup>	150 mA
Reverse Voltage	5 V
Operating Temperature Range	-25 ~ +85°C
Storage Temperature Range	-30 ~ +100°C
Lead Soldering Temperature ( 3 mm from the base of the epoxy bulb ) <sup>2</sup>	260°C

Notes: 1. 10% Duty Cycle, Pulse Width ≤ 0.1 msec.    2. Solder time less than 5 seconds at temperature extreme.

## Electrical / Optical Characteristics

T<sub>A</sub> = 25°C & I<sub>F</sub> = 20 mA unless otherwise noted

Part Number	Forward Voltage (V) <sup>1</sup>			Recommend Forward Current (mA)			Reverse Current (μA)	Dominant Wavelength (nm) <sup>2</sup>			Luminous Intensity I <sub>v</sub> (mcd)			Viewing Angle 2 Θ ½ (deg)
	MIN	TYP	MAX	MIN	TYP	MAX	MAX	MIN	TYP	MAX	MIN	TYP	MAX	TYP
3HC-201-S								/	/	/	/	50	/	20
3HD-201-S	/	2.0	2.8	/	20	/	100	/	/	/	/	30	/	35
3HT-201-S								/	/	/	/	50	/	20

Notes: 1. Tolerance of forward voltage : ±0.05V.    2. Tolerance of dominant wavelength : ±1.0nm.

Bivar reserves the right to make changes at any time without notice.

# 3mm (T1) Package Discrete LED RED, Extended Profile



## Typical Electrical / Optical Characteristics

$T_A = 25^\circ\text{C}$  unless otherwise noted

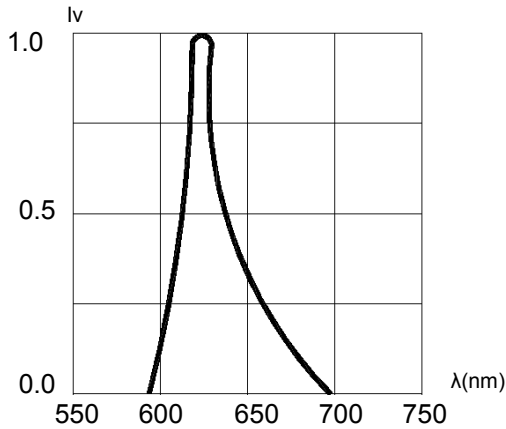

Fig. 1 Relative Luminous Intensity vs. Wavelength @ 20mA

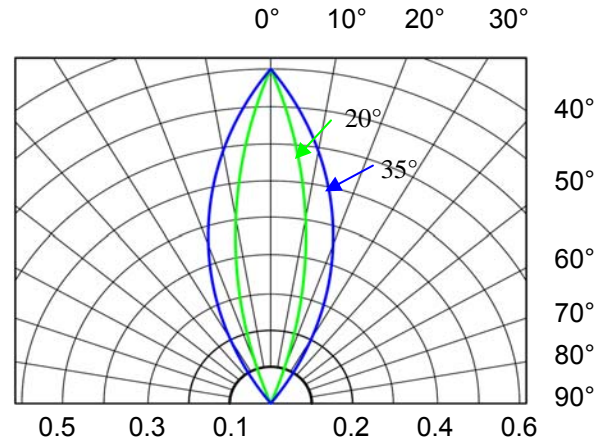

Fig. 2 Directivity Radiation Diagram

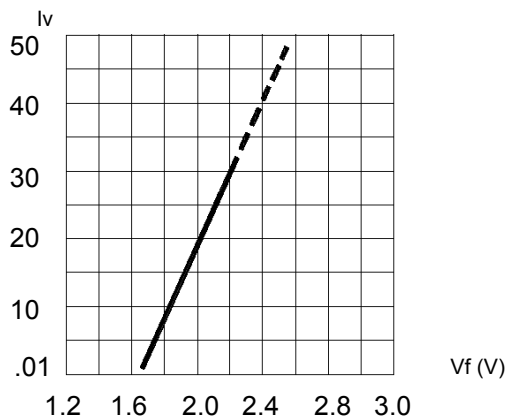

Fig. 3 Relative Intensity (10mA) vs. Forward Voltage

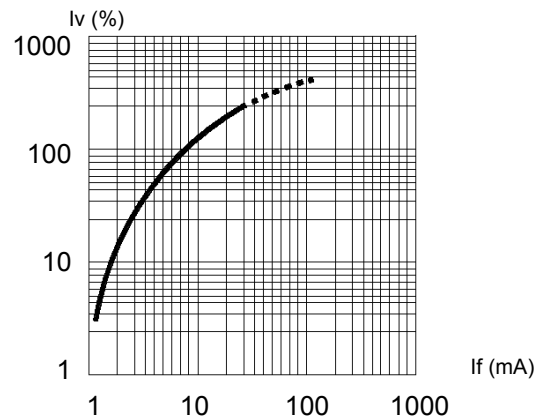

Fig. 4 Relative Luminous Intensity (%) vs. Forward Current

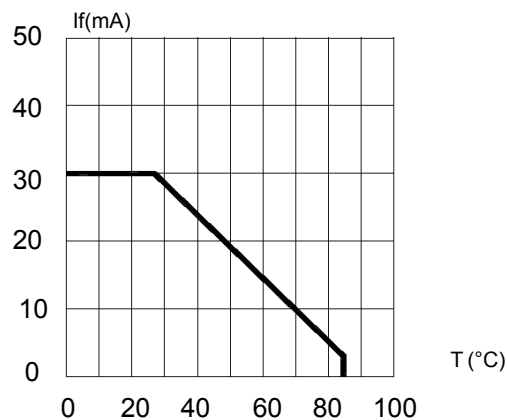

Fig. 5 Forward Current vs. Temperature

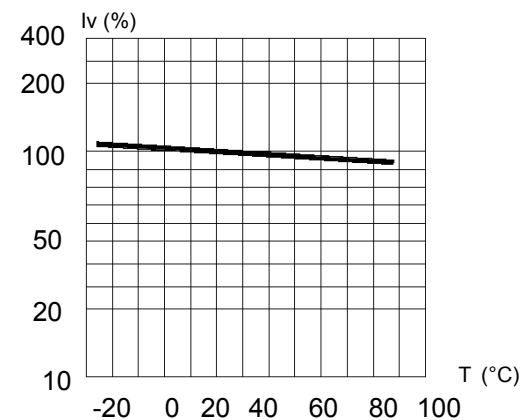

Fig. 6 Relative Intensity (%) vs. Temperature @ 20 mA

Bivar reserves the right to make changes at any time without notice.

# 3mm (T1) Package Discrete LED RED, Extended Profile



## Recommended Soldering Conditions



Recommended Lead Free Wave Soldering Profile	
Preheat Temperature: 100°C Max.	Peak Temperature: 260°C Max.
Preheat Time: 20 ~ 50 Seconds	Solder Time Above 217°C: 5 Seconds Max.
Note: Turn off top heater at preheat to prevent the lamp body directly exposed to the heat source.	

## Packaging and Labeling Plan



**Bivar, Inc.** MSL 1

4 Thomas, Irvine, CA 92618-2593  
LOT: XXX.XXXXX.XX



Part: **XXXX-XXX-XXX**

Quantity: **.500**

RoHS Compliant

Anti-Static Poly Bag with Desiccant  
(500 pcs Max. per Bag)

Bivar reserves the right to make changes at any time without notice.