

MAX2181A

FM Automotive Low-Noise Amplifier

General Description

The MAX2181A is a highly integrated FM variable-gain low-noise amplifier ideal for use in automotive FM and FM-diversity active antenna applications. The device features an FM signal path, providing 30dB of gain range, controlled by an on-chip power detector. The FM signal path covers 76MHz to 162.5MHz.

The device is available in a small, 3mm x 3mm, TQFN package and operates over the extended industrial temperature range (-40°C to +85°C).

Applications

- Automotive Active Antenna
- Automotive Head Unit

Ordering Information appears at end of data sheet.

For related parts and recommended products to use with this part, refer to www.maximintegrated.com/MAX2181A.related.

Features

- +5V Supply Voltage
- Integrated AGC Function Eliminates External Pin Diodes
- High Dynamic Range
- Low-Noise, Sub 3dB Noise Figure
- Low External BOM
- Small Package (3mm x 3mm TQFN)
- Integrated Power Detector

Simplified Block Diagram

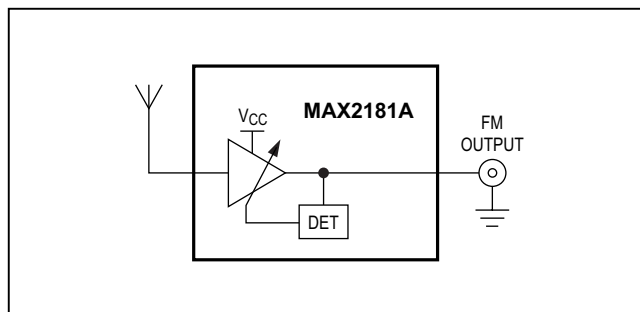

Absolute Maximum Ratings

V _{DD} , FMBYPASS, FMOUT.....	-0.5V to +6V	Operating Temperature Range.....	-40°C to +105°C
Short-Circuit Protection FMOUT	Indefinite	Junction Temperature.....	+150°C
FMIN.....	130dBμV	Storage Temperature Range.....	-65°C to +165°C
Continuous Power Dissipation (T _A = +70°C)		Lead Temperature (TQFN only, soldering, 10s).....	+300°C
16 TQFN (derate 20.8mW/°C above +70°C)	1666.7mW	Soldering Temperature (reflow).....	+260°C
θ _{JC} (Junction to Case) (Note 1).....	7°C/W		
θ _{JA} (Junction to Ambient) (Note 1).....	48°C/W		

Note 1: Package thermal resistances were obtained using the method described in JEDEC specification JESD51-7, using a four-layer board. For detailed information on package thermal considerations, refer to www.maximintegrated.com/thermal-tutorial.

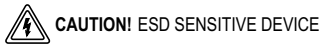

Stresses beyond those listed under "Absolute Maximum Ratings" may cause permanent damage to the device. These are stress ratings only, and functional operation of the device at these or any other conditions beyond those indicated in the operational sections of the specifications is not implied. Exposure to absolute maximum rating conditions for extended periods may affect device reliability.

DC Electrical Characteristics

(MAX2181A Typical Application Circuit as shown, V_{DD} = 4.75V to 5.25V, T_A = -40°C to +85°C, unless otherwise noted. Typical values are at V_{DD} = 5V, T_A = +25°C.) (Note 2)

PARAMETER	CONDITIONS	MIN	TYP	MAX	UNITS
SUPPLY VOLTAGE (V_{DD})					
V _{DD}	Operational range	4.75	5	5.25	V
Supply Current			56	68	mA
GAIN CONTROL AND AGC CONTROL (FMDET, FMGAIN, FMAGC)					
FMDET	Ground	-65			μA
	VDD			50	
FMGAIN	Ground	-50			μA
	Open		2.5		V
	VDD			50	μA
FMAGC	Ground	-50			μA
	VDD			50	

AC Electrical Characteristics

(MAX2181A *Typical Application Circuit*, $V_{DD} = 4.75V$ to $5.25V$, $T_A = -40^\circ C$ to $+85^\circ C$, unless otherwise noted. Typical values are at $V_{DD} = 5V$, load impedance = 50Ω , FM gain connected to ground, tuned for 87MHz to 108MHz, $T_A = +25^\circ C$.) (Note 2)

PARAMETER	CONDITIONS	MIN	TYP	MAX	UNITS
Frequency Range		76		162.5	MHz
Power Gain Maximum	$f_{IN} = 97MHz$, FMGAIN connected to V_{DD}	6	8.3	10	dB
	$f_{IN} = 97MHz$, FMGAIN = open	5	7.2	9	
	$f_{IN} = 97MHz$, FMGAIN = connected to ground	4	6	8	
Gain Flatness	76MHz to 90MHz (Notes 3, 4)			0.5	dB
	87MHz to 108MHz (Note 3)			0.5	
	162.5MHz relative to 97MHz			3.2	
Noise Figure	$f_{IN} = 97MHz$, $T_A = +25^\circ C$		2.5		dB
Input Return Loss	50Ω source		10		dB
Output Return Loss	50Ω load		15		dB
Gain-Control Range	$f_{IN} = 97MHz$	28	32		dB
IMD3	$V_{IN} = +120dB\mu V$ /tone, $+100dB\mu V$ AGC threshold, 99.5MHz and 100.5MHz tones		66		dBc
AGC Threshold (See Table 2)	Minimum output threshold		92		dB μV
	Maximum output threshold		107		
AGC Threshold Variation	Relative to 97MHz tone (76MHz to 108MHz)		± 0.3		dB

Note 2: Min and max values are production tested at $T_A = -40^\circ C$, $+25^\circ C$, and $+85^\circ C$.

Note 3: Guaranteed by design and characterization.

Note 4: Tuned for 76MHz to 90MHz

Typical Operating Characteristics

(MAX2181A Typical Application Circuit, $V_{DD} = 5V$, tuned for 87MHz - 108MHz, FM gain connected to ground, $T_A = +25^\circ C$, unless otherwise noted.)

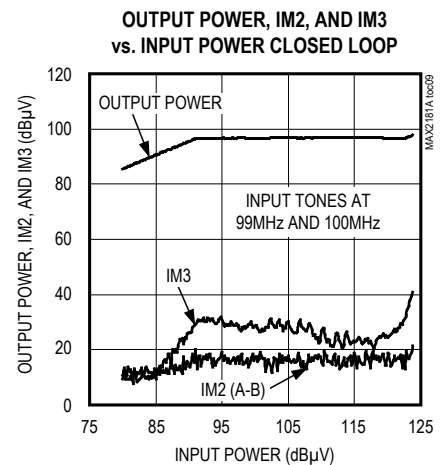
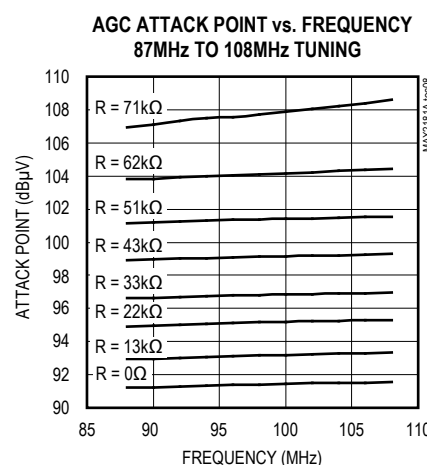
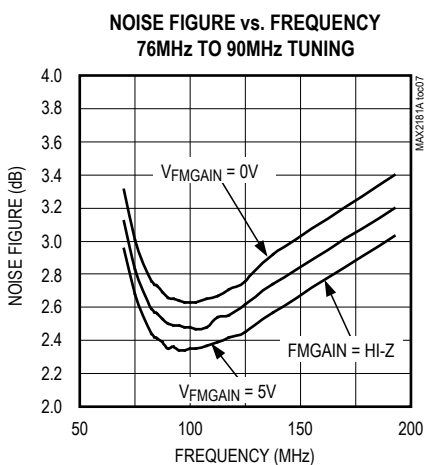
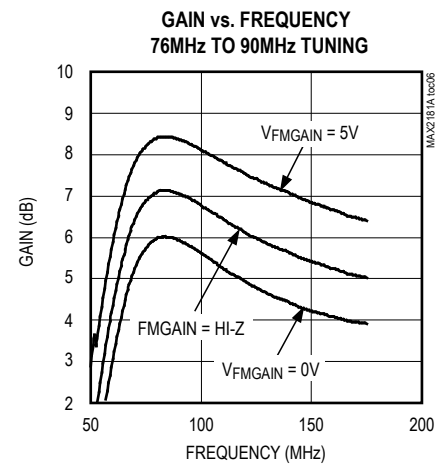
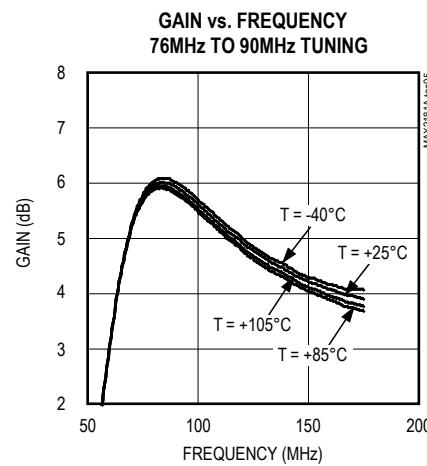
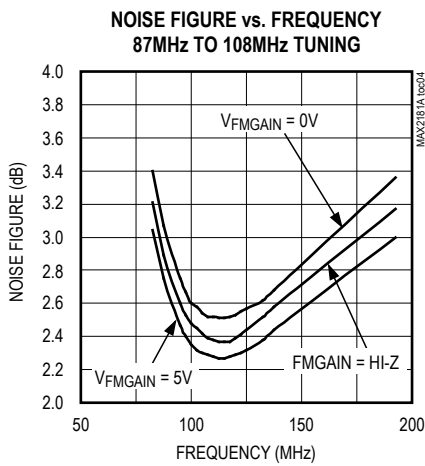
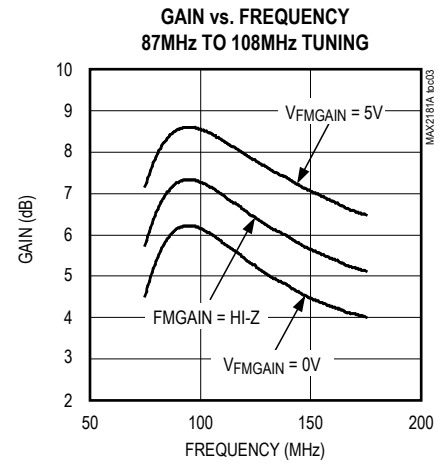
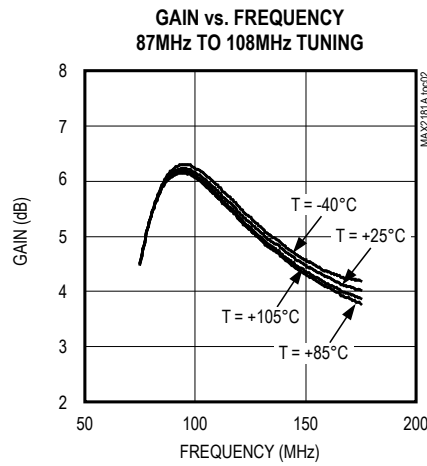
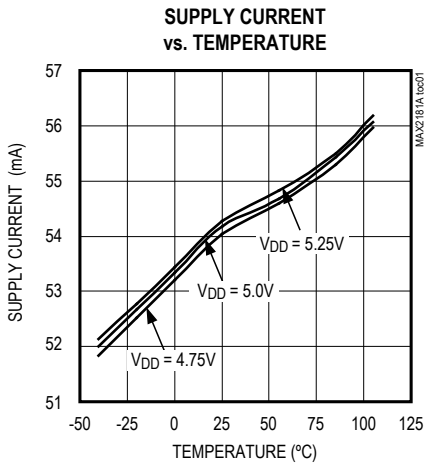

Pin Configuration

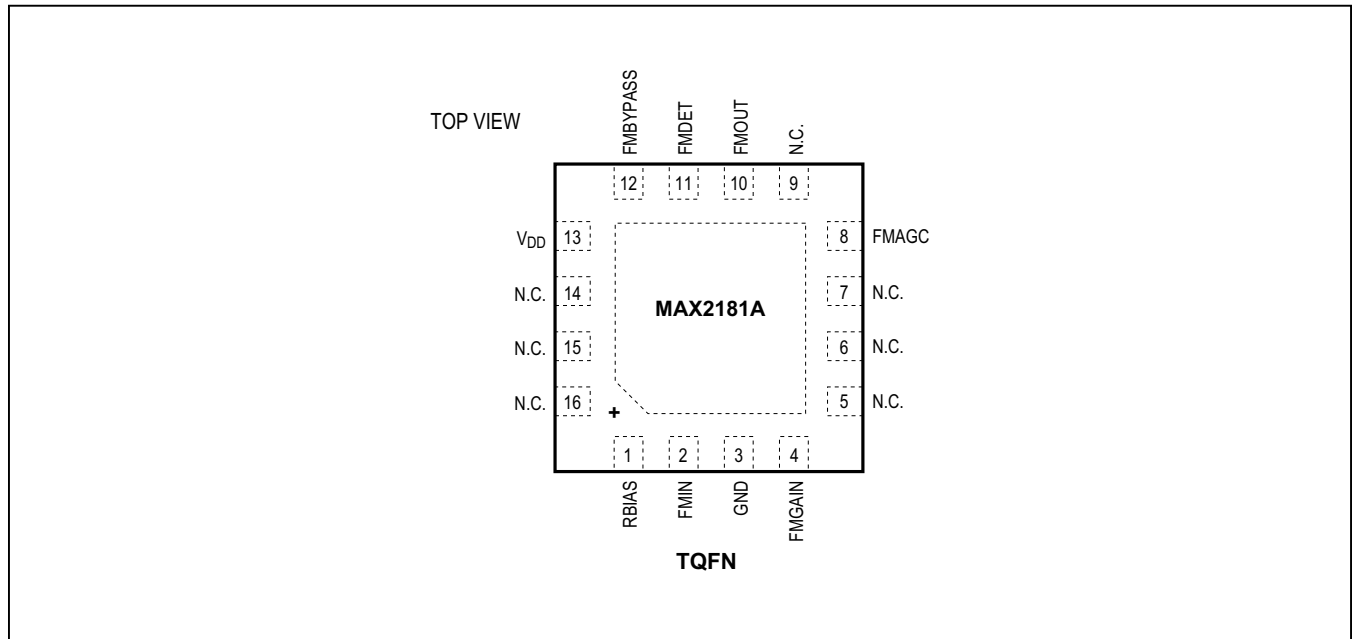

Pin Description

PIN	NAME	FUNCTION
1	RBIAS	Connect a 1% tolerance 20kΩ resistor to ground.
2	FMIN	FM Input. AC couple to FM input bandpass filter.
3	GND	Ground
4	FMGAIN	FM Gain Trim. Connect to ground, leave open, or connect to V _{DD} for the desired FM gain.
5–7, 9, 14–16	N.C.	No Connection to Die. Suggested thermal path on Layer 1 of PCB for packages exposed pad to thermal sink.
8	FMAGC	FM AGC Control Line. Connect a 1μF capacitor to ground.
10	FMOUT	FM VGA Output
11	FMDET	FM Attack Point Trim. Connect the desired resistor to ground.
12	FMBYPASS	Connect a 10μF and 1000pF capacitor to ground.
13	V _{DD}	Supply Voltage
—	EP	Exposed Pad. Ground.

Detailed Description

Setting Signal Path Gain and AGC Attack Point

The MAX2181A allows independent variation of the gain and AGC attack points on the FM signal path. Gain and attack point are adjusted by changing the conditions on the FMGAIN and FMDET pins.

FM Signal Path

Typical FM gain can be set using the FMGAIN pin as shown in Table 1. The output attack point of the FM signal path is adjusted by changing the resistor R_{FMDET} , connected to the FMDET pin. Table 2 shows the attack point associated with several resistor values.

Layout Recommendations

For best performance, the device must be mounted on a PCB that is designed for a low thermal resistance. The backside ground of the MAX2181A should be connected to a thermal ground plane on the PCB using at least nine plated through holes.

Refer to www.maximintegrated.com for the MAX2181A Evaluation Kit schematic, Gerber data, PADS layout file, and BOM information.

Table 1. FM Signal Path Gain

PIN FMGAIN	FM GAIN (dB, TYP)
Ground	6.0
Open	7.2
V _{DD}	8.3

Table 2. FM Signal Path Attack Point

R _{FMDET} (kΩ)	FM OUTPUT ATTACK POINT (dBμV, TYP)
0	92
13	93.5
22	95
33	97
43	99
51	101.5
62	104
71	107

Typical Application Circuit

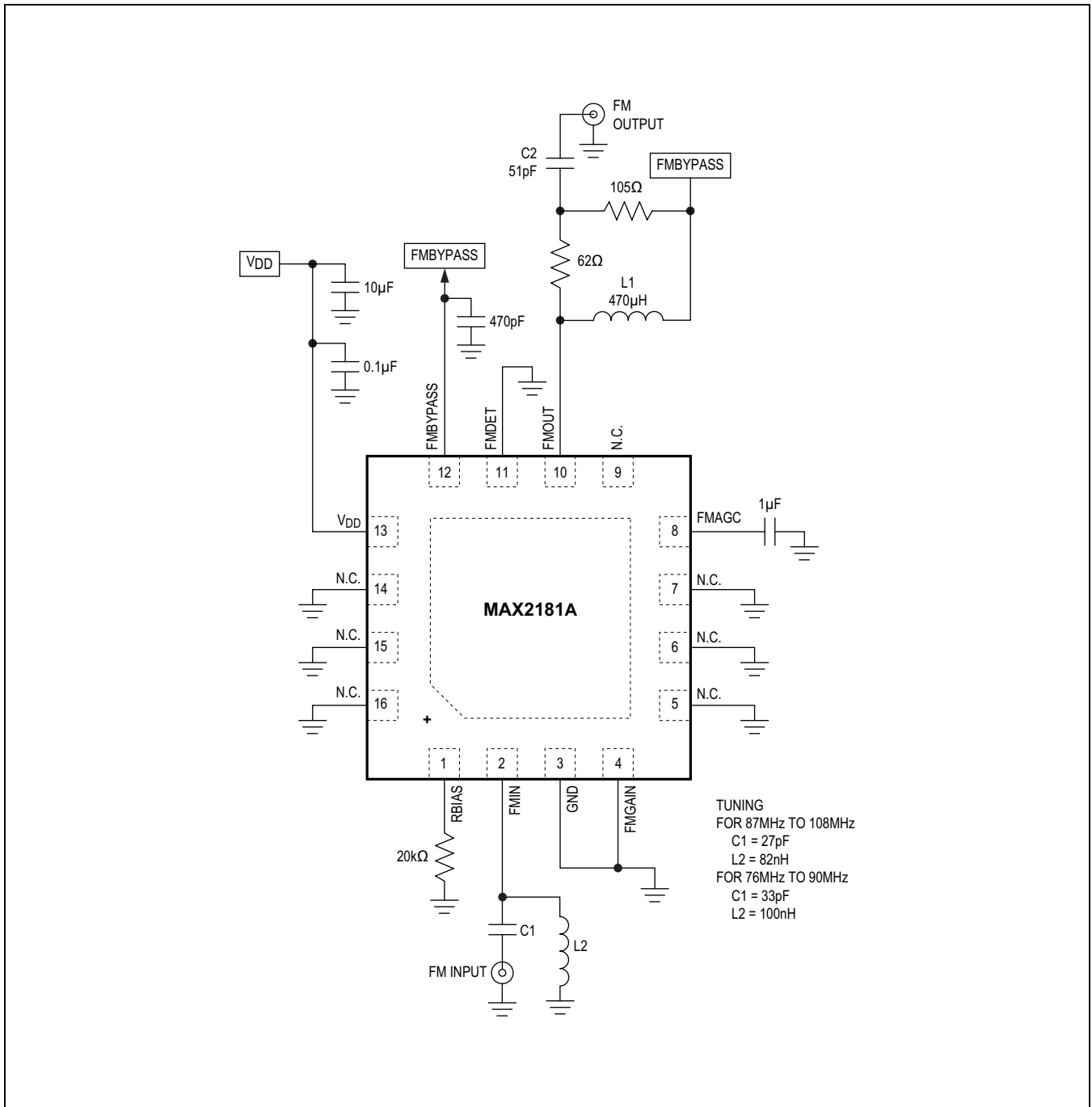

Ordering Information

PART	TEMP RANGE	PIN-PACKAGE
MAX2181AETE+	-40°C to +85°C	16 TQFN-EP*
MAX2181AETE/V+	-40°C to +85°C	16 TQFN-EP*

+Denotes a lead(Pb)-free/RoHS-compliant package.

*EP = Exposed pad.

/V denotes an automotive qualified part.

Package Information

For the latest package outline information and land patterns (footprints), go to www.maximintegrated.com/packages. Note that a "+", "#", or "-" in the package code indicates RoHS status only. Package drawings may show a different suffix character, but the drawing pertains to the package regardless of RoHS status.

PACKAGE TYPE	PACKAGE CODE	OUTLINE NO.	LAND PATTERN NO.
16 TQFN	T1633+2	21-0136	90-0030

Revision History

REVISION NUMBER	REVISION DATE	DESCRIPTION	PAGES CHANGED
0	2/13	Initial release	—

For pricing, delivery, and ordering information, please contact Maxim Direct at 1-888-629-4642, or visit Maxim Integrated's website at www.maximintegrated.com.

Maxim Integrated cannot assume responsibility for use of any circuitry other than circuitry entirely embodied in a Maxim Integrated product. No circuit patent licenses are implied. Maxim Integrated reserves the right to change the circuitry and specifications without notice at any time. The parametric values (min and max limits) shown in the Electrical Characteristics table are guaranteed. Other parametric values quoted in this data sheet are provided for guidance.