

REVISIONS				
REV.	ECO. NO	DESCRIPTION	DATE	BY
A	1308	INITIAL RELEASE	03-20-06	MNH

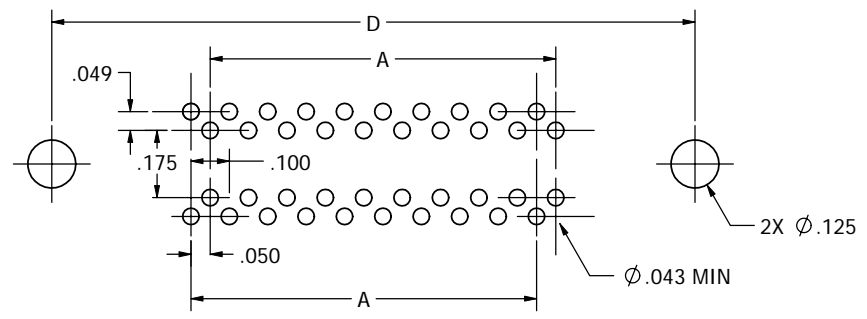
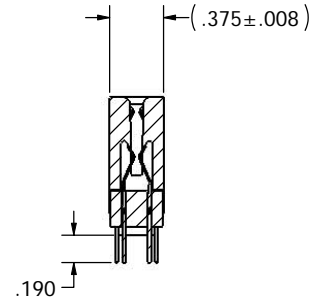
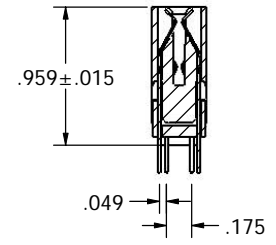
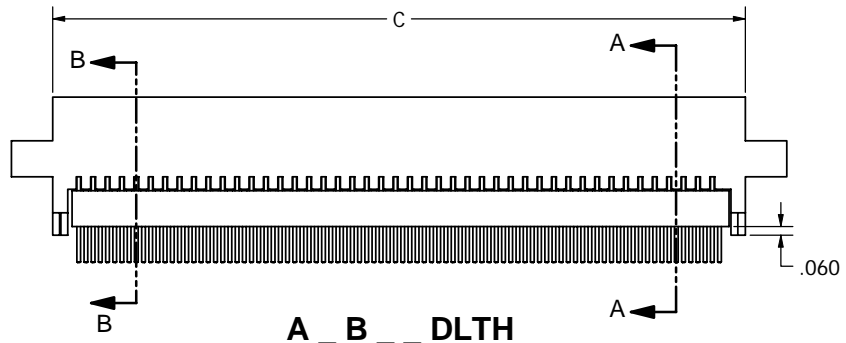
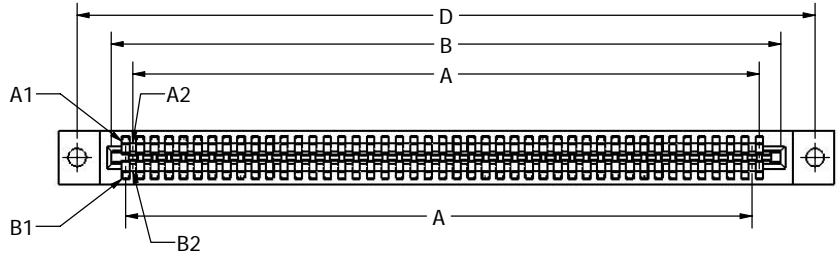

RECOMMENDED PCB LAYOUT  
COMPONENT SIDE

- NOTES:
1. INSULATOR MATERIAL: PPS\PA9T
  2. CONTACT MATERIAL: BERYLLIUM COPPER
  3. PLATING: SEE PART NUMBER CODING
  4. TEMPERATURE: -65°C TO +150°C
  5. PROCESSING TEMP: 260°C FOR 120 SECONDS MAX
  6. UL FLAMMABILITY RATING: 94V-0
  7. VOLTAGE RATING: 125 VDC MINIMUM AT SEA LEVEL.
  8. CURRENT RATING: 3 AMP PER CONTACT PAIR
  9. INSULATION RESISTANCE: 5000 MEGA OHM
  10. CONTACT RESISTANCE: 30 MV AT RATED CURRENT
  11. CONNECTOR IDENTIFICATION: THE PART SHALL BE MARKED WITH A PART NUMBER AND BARCODE
  12. BOARD THICKNESS ACCOMMODATED: .062 ± .008"
  13. BOARD INSERTION FORCE: 16 OZ MAX PER CONTACT PAIR WHEN USING A .062" TEST BLADE. INTERNAL INSPECTION TO BE PER SULLIN'S WORK INSTRUCTION W17.3-01.
  14. BOARD WITHDRAWAL FORCE: 1 OUNCE MINIMUM PER CONTACT PAIR USING .062" PCB
  15. CONTACT NORMAL FORCE: 75 GRAMS MINIMUM.

PRELIMINARY

# CUSTOMER COPY



RoHS COMPLIANT

UNLESS OTHERWISE SPECIFIED: DIMENSIONS ARE IN INCHES[MM]		DATE	NAME
TOLERANCES: ANGULAR: ± 1° XX = ± .02 [ .508] .XXX = ± .005 [ .127] XXXX = ± .0005 [ .0127] PARENTHETICAL INFORMATION IS FOR REFERENCE ONLY		03-20-06	MNH
THE INFORMATION HEREIN CONTAINS PROPRIETARY INFORMATION OF SULLINS ELECTRONICS AND IS NOT TO BE REPRODUCED, USED OR DISCLOSED TO OTHERS FOR ANY PURPOSE EXCEPT AS SPECIFICALLY AUTHORIZED IN WRITING BY AN OFFICER OF SULLINS ELECTRONICS.		DESCRIPTION BI-LEVEL, .050" CC	
INTERPRET DIMENSIONS AND GEOMETRIC TOLERANCING PER: ANSI Y14.5-1984		SIZE	DWG. NO
		C	C10812
		REV	A
SCALE: 1:1		SHEET 1 OF 3	

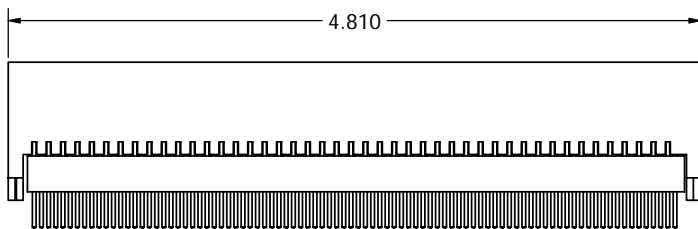

**A \_ B \_ \_ DLTN**

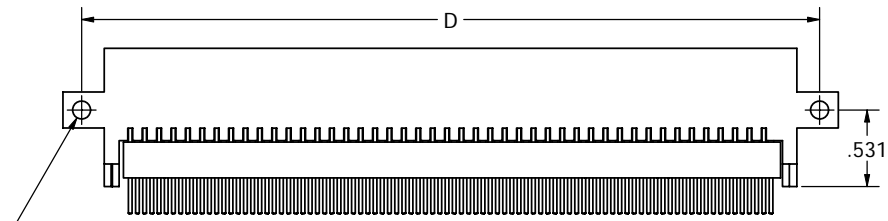

**A \_ B \_ \_ DLTS**

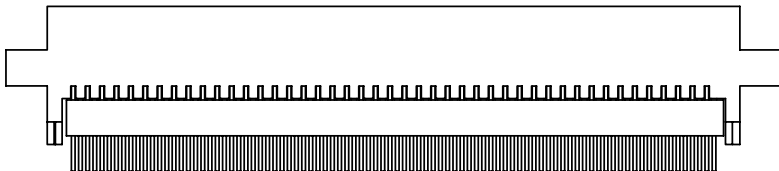
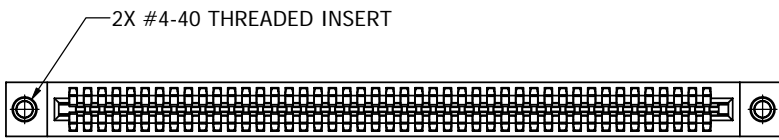

**A \_ B \_ \_ DLTI**

PART NUMBER	INCHES						POSITIONS	MILLIMETERS						POSITIONS	DAUGHTER CARD LAYOUT
	A	B	C±.015	D±.010	E±.020	F		A	B	C±0.38	D±0.25	E±0.51	F		
A_B06DLT	0.200	0.450	0.610	0.925	1.185	0.436	6	5.08	11.43	15.49	23.50	30.10	11.07	6	1
A_B08DLT	0.300	0.550	0.710	1.025	1.285	0.536	8	7.62	13.97	18.03	26.04	32.64	13.61	8	2
A_B10DLT	0.400	0.650	0.810	1.125	1.385	0.636	10	10.16	16.51	20.57	28.58	35.18	16.15	10	1
A_B12DLT	0.500	0.750	0.910	1.225	1.485	0.736	12	12.70	19.05	23.11	31.12	37.72	18.69	12	2
A_B14DLT	0.600	0.850	1.010	1.325	1.585	0.836	14	15.24	21.59	25.65	33.66	40.26	21.23	14	1
A_B16DLT	0.700	0.950	1.110	1.425	1.685	0.936	16	17.78	24.13	28.19	36.20	42.80	23.77	16	2
A_B18DLT	0.800	1.050	1.210	1.525	1.785	1.036	18	20.32	26.67	30.73	38.74	45.34	26.31	18	1
A_B20DLT	0.900	1.150	1.310	1.625	1.885	1.136	20	22.86	29.21	33.27	41.28	47.88	28.85	20	2
A_B22DLT	1.000	1.250	1.410	1.725	1.985	1.236	22	25.40	31.75	35.81	43.82	50.42	31.39	22	1
A_B24DLT	1.100	1.350	1.510	1.825	2.085	1.336	24	27.94	34.29	38.35	46.36	52.96	33.93	24	2
A_B26DLT	1.200	1.450	1.610	1.925	2.185	1.436	26	30.48	36.83	40.89	48.90	55.50	36.47	26	1
A_B28DLT	1.300	1.550	1.710	2.025	2.285	1.536	28	33.02	39.37	43.43	51.44	58.04	39.01	28	2
A_B30DLT	1.400	1.650	1.810	2.125	2.385	1.636	30	35.56	41.91	45.97	53.98	60.58	41.55	30	1
A_B32DLT	1.500	1.750	1.910	2.225	2.485	1.736	32	38.10	44.45	48.51	56.52	63.12	44.09	32	2
A_B34DLT	1.600	1.850	2.010	2.325	2.585	1.836	34	40.64	46.99	51.05	59.06	65.66	46.63	34	1
A_B36DLT	1.700	1.950	2.110	2.425	2.685	1.936	36	43.18	49.53	53.59	61.60	68.20	49.17	36	2
A_B38DLT	1.800	2.050	2.210	2.525	2.785	2.036	38	45.72	52.07	56.13	64.14	70.74	51.71	38	1
A_B40DLT	1.900	2.150	2.310	2.625	2.885	2.136	40	48.26	54.61	58.67	66.68	73.28	54.25	40	2
A_B42DLT	2.000	2.250	2.410	2.725	2.985	2.236	42	50.80	57.15	61.21	69.22	75.82	56.79	42	1
A_B44DLT	2.100	2.350	2.510	2.825	3.085	2.336	44	53.34	59.69	63.75	71.76	78.36	59.33	44	2
A_B46DLT	2.200	2.450	2.610	2.925	3.185	2.436	46	55.88	62.23	66.29	74.30	80.90	61.87	46	1
A_B48DLT	2.300	2.550	2.710	3.025	3.285	2.536	48	58.42	64.77	68.83	76.84	83.44	64.41	48	2
A_B50DLT	2.400	2.650	2.810	3.125	3.385	2.636	50	60.96	67.31	71.37	79.38	85.98	66.95	50	1
A_B52DLT	2.500	2.750	2.910	3.225	3.485	2.736	52	63.50	69.85	73.91	81.92	88.52	69.49	52	2
A_B54DLT	2.600	2.850	3.010	3.325	3.585	2.836	54	66.04	72.39	76.45	84.46	91.06	72.03	54	1
A_B56DLT	2.700	2.950	3.110	3.425	3.685	2.936	56	68.58	74.93	78.99	87.00	93.60	74.57	56	2
A_B58DLT	2.800	3.050	3.210	3.525	3.785	3.036	58	71.12	77.47	81.53	89.54	96.14	77.11	58	1
A_B60DLT	2.900	3.150	3.310	3.625	3.885	3.136	60	73.66	80.01	84.07	92.08	98.68	79.65	60	2
A_B62DLT	3.000	3.250	3.410	3.725	3.985	3.236	62	76.20	82.55	86.61	94.62	101.22	82.19	62	1
A_B64DLT	3.100	3.350	3.510	3.825	4.085	3.336	64	78.74	85.09	89.15	97.16	103.76	84.73	64	2
A_B66DLT	3.200	3.450	3.610	3.925	4.185	3.436	66	81.28	87.63	91.69	99.70	106.30	87.27	66	1
A_B68DLT	3.300	3.550	3.710	4.025	4.285	3.536	68	83.82	90.17	94.23	102.24	108.84	89.81	68	2
A_B70DLT	3.400	3.650	3.810	4.125	4.385	3.636	70	86.36	92.71	96.77	104.78	111.38	92.35	70	1
A_B72DLT	3.500	3.750	3.910	4.225	4.485	3.736	72	88.90	95.25	99.31	107.32	113.92	94.89	72	2
A_B74DLT	3.600	3.850	4.010	4.325	4.585	3.836	74	91.44	97.79	101.85	109.86	116.46	97.43	74	1
A_B76DLT	3.700	3.950	4.110	4.425	4.685	3.936	76	93.98	100.33	104.39	112.40	119.00	99.97	76	2
A_B78DLT	3.800	4.050	4.210	4.525	4.785	4.036	78	96.52	102.87	106.93	114.94	121.54	102.51	78	1
A_B80DLT	3.900	4.150	4.310	4.625	4.885	4.136	80	99.06	105.41	109.47	117.48	124.08	105.05	80	2
A_B82DLT	4.000	4.250	4.410	4.725	4.985	4.236	82	101.60	107.95	112.01	120.02	126.62	107.59	82	1
A_B84DLT	4.100	4.350	4.510	4.825	5.085	4.336	84	104.14	110.49	114.55	122.56	129.16	110.13	84	2
A_B86DLT	4.200	4.450	4.610	4.925	5.185	4.436	86	106.68	113.03	117.09	125.10	131.70	112.67	86	1
A_B88DLT	4.300	4.550	4.710	5.025	5.285	4.536	88	109.22	115.57	119.63	127.64	134.24	115.21	88	2
A_B90DLT	4.400	4.650	4.810	5.125	5.385	4.636	90	111.76	118.11	122.17	130.18	136.78	117.75	90	1
A_B92DLT	4.500	4.750	4.910	5.225	5.485	4.736	92	114.30	120.65	124.71	132.72	139.32	120.29	92	2
A_B94DLT	4.600	4.850	5.010	5.325	5.585	4.836	94	116.84	123.19	127.25	135.26	141.86	122.83	94	1
A_B96DLT	4.700	4.950	5.110	5.425	5.685	4.936	96	119.38	125.73	129.79	137.80	144.40	125.37	96	2
A_B98DLT	4.800	5.050	5.210	5.525	5.785	5.036	98	121.92	128.27	132.33	140.34	146.94	127.91	98	1
A_B100DLT	4.900	5.150	5.310	5.625	5.885	5.136	100	124.46	130.81	134.87	142.88	149.48	130.45	100	2

**PART NUMBER CODING**

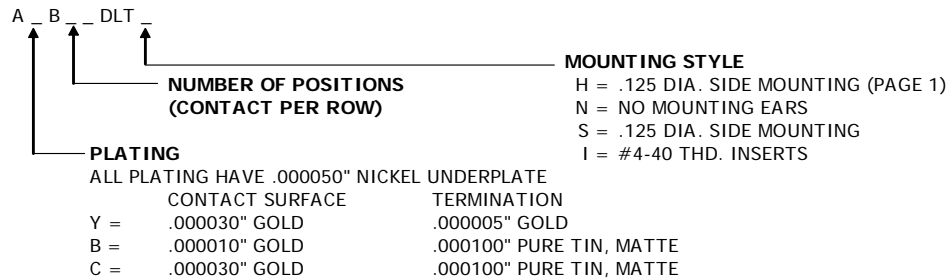

RoHS COMPLIANT

**CUSTOMER COPY**

UNLESS OTHERWISE SPECIFIED: DIMENSIONS ARE IN INCHES[MM]		DATE	NAME
TOLERANCES: ANGULAR: ± 1° XX ± .02 [ .508] .XXX ± .005 [ .1270] XXXX ± .0005 [ .0127] PARENTHETICAL INFORMATION IS FOR REFERENCE ONLY		DRAWN	MNH
INTERPRET DIMENSIONS AND GEOMETRIC TOLERANCING PER: ANSI Y14.5-1984		THE INFORMATION HEREIN CONTAINS PROPRIETARY INFORMATION OF SULLINS ELECTRONICS AND IS NOT TO BE REPRODUCED, USED OR DISCLOSED TO OTHERS FOR ANY PURPOSE EXCEPT AS SPECIFICALLY AUTHORIZED IN WRITING BY AN OFFICER OF SULLINS ELECTRONICS.	
SULLINS ELECTRONICS		DESCRIPTION	
BI-LEVEL, .050" CC		PART NUMBER	
A_B_DLT		A_B_DLT	
SIZE	DWG. NO.	REV	
C	C10812	A	
SCALE: 1.5:1		SHEET 2 OF 3	

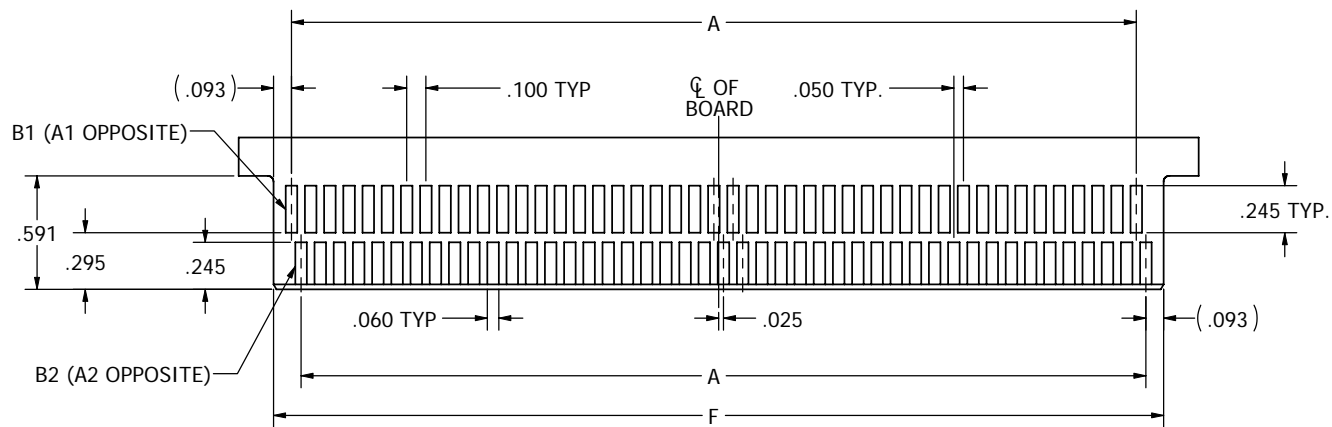

DAUGHTER CARD LAYOUT NUMBER 1  
90 POSITION SHOWN  
REFER TO PAGE 2 TO DETERMINE LAYOUT TO USE

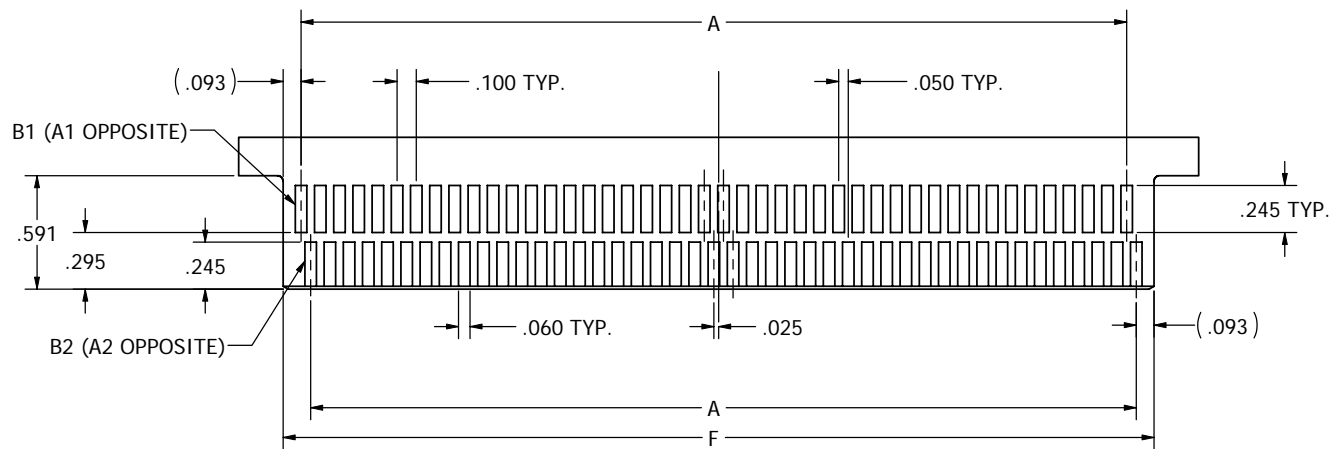

DAUGHTER CARD LAYOUT NUMBER 2  
88 POSITION SHOWN  
REFER TO PAGE 2 TO DETERMINE LAYOUT TO USE

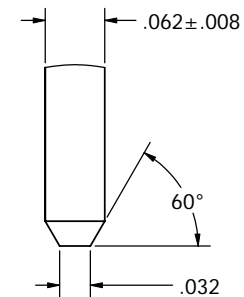
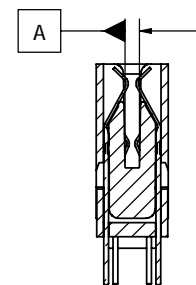
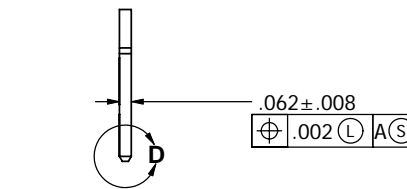

DETAIL D  
SCALE 10 : 1

**CUSTOMER COPY**



RoHS COMPLIANT

UNLESS OTHERWISE SPECIFIED:  
DIMENSIONS ARE IN INCHES[MM]  
TOLERANCES:  
ANGULAR: ± 1°  
XX = ± .02 [ .508]  
.XXX = ± .005 [ .1270]  
XXXX = ± .0005 [ .0127]  
PARENTHESES INFORMATION IS FOR REFERENCE ONLY  
INTERPRET DIMENSIONS AND GEOMETRIC TOLERANCING PER: ANSI Y14.5-1984

DRAWN	DATE	NAME
03-20-06	MNH	
THE INFORMATION HEREIN CONTAINS PROPRIETARY INFORMATION OF SULLINS ELECTRONICS AND IS NOT TO BE REPRODUCED, USED OR DISCLOSED TO OTHERS FOR ANY PURPOSE EXCEPT AS SPECIFICALLY AUTHORIZED IN WRITING BY AN OFFICER OF SULLINS ELECTRONICS.		
SIZE	DWG. NO.	REV
C	C10812	A

<b>SULLINS ELECTRONICS</b> DESCRIPTION BI-LEVEL, .050" CC	
PART NUMBER	
A_B_DLT_	
SCALE: 1.5:1	SHEET 3 OF 3