

LAPT 2SC3519/3519A

Silicon NPN Epitaxial Planar Transistor (Complement to type 2SA1386/A)

Application : Audio and General Purpose

Absolute maximum ratings (Ta=25°C)

Symbol	Ratings		Unit
	2SC3519	2SC3519A	
V _{CB0}	160	180	V
V _{CE0}	160	180	V
V _{EB0}	5		V
I _C	15		A
I _B	4		A
P _c	130(Tc=25°C)		W
T _j	150		°C
T _{stg}	-55 to +150		°C

Electrical Characteristics

Symbol	Conditions	Ratings		Unit
		2SC3519	2SC3519A	
I _{CB0}	V _{CB} =	160	180	μA
I _{EB0}	V _{EB} =5V	100max		μA
V _{(BR)CEO}	I _C =25mA	160min	180min	V
h _{FE}	V _{CE} =4V, I _C =5A	50min*		
V _{CE(sat)}	I _C =5A, I _B =0.5A	2.0max		V
f _r	V _{CE} =12V, I _E =-2A	50typ		MHz
C _{OB}	V _{CB} =10V, f=1MHz	250typ		pF

*h_{FE} Rank: \bar{O} (50 to 100), P(70 to 140), Y(90 to 180)

Typical Switching Characteristics (Common Emitter)

V _{CC} (V)	R _L (Ω)	I _C (A)	V _{BB1} (V)	V _{BB2} (V)	I _{B1} (A)	I _{B2} (A)	t _{on} (μs)	t _{stg} (μs)	t _f (μs)
40	4	10	10	-5	1	-1	0.2typ	1.3typ	0.45typ

External Dimensions MT-100(TO3P)

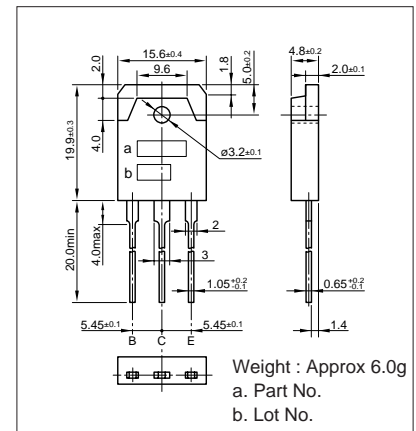

I_C-V_{CE} Characteristics (Typical)

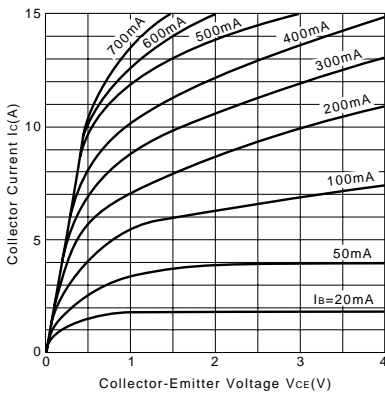

V_{CE(sat)}-I_B Characteristics (Typical)

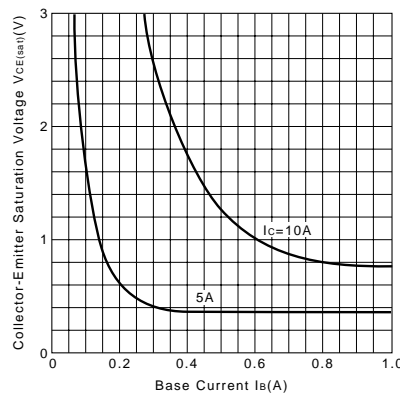

I_C-V_{BE} Temperature Characteristics (Typical)

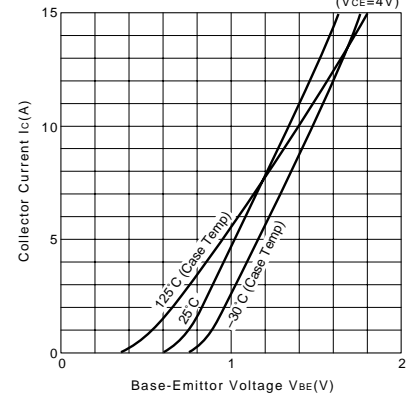

h_{FE}-I_C Characteristics (Typical)

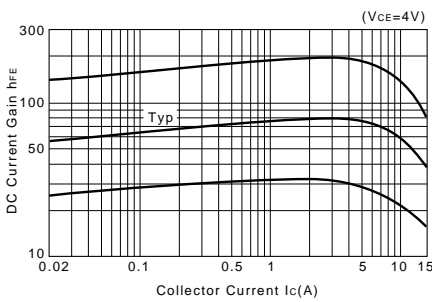

h_{FE}-I_C Temperature Characteristics (Typical)

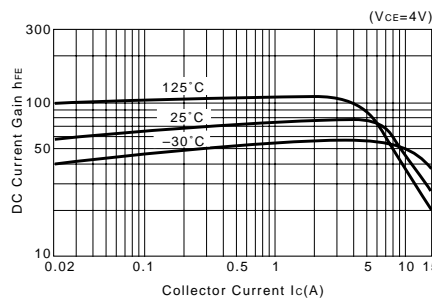

θ_{j-a}-t Characteristics

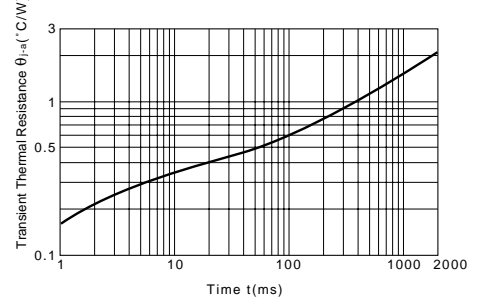

f_T-I_E Characteristics (Typical)

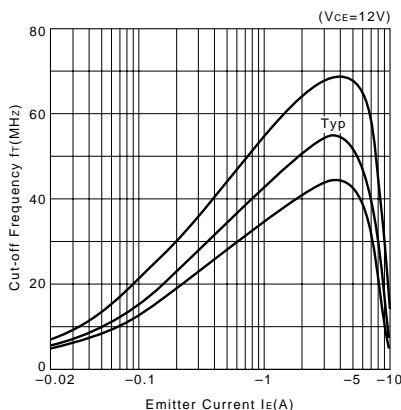

Safe Operating Area (Single Pulse)

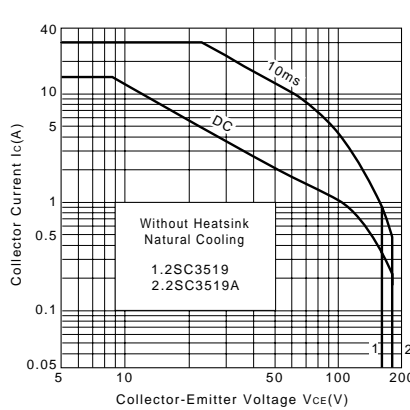

P_c-T_a Derating

