

LOC	DIST	REVISIONS			
P	LTR	DESCRIPTION	DATE	DWN	APVD
CM	00	A1	ECO-07-016419	02AUG2007	KW CJ

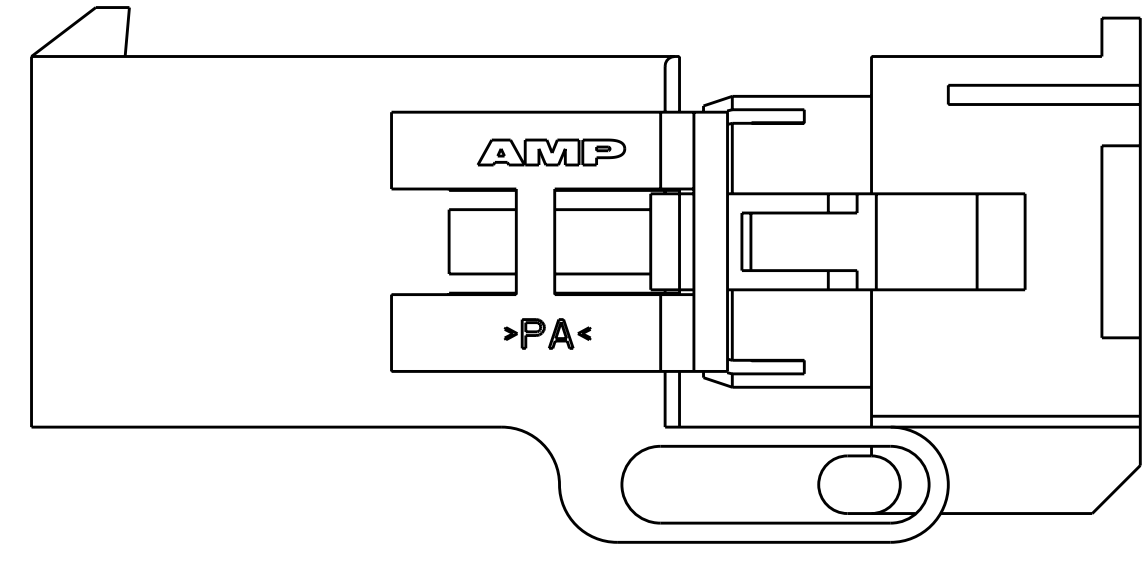

PRE-STAGED CONDITION

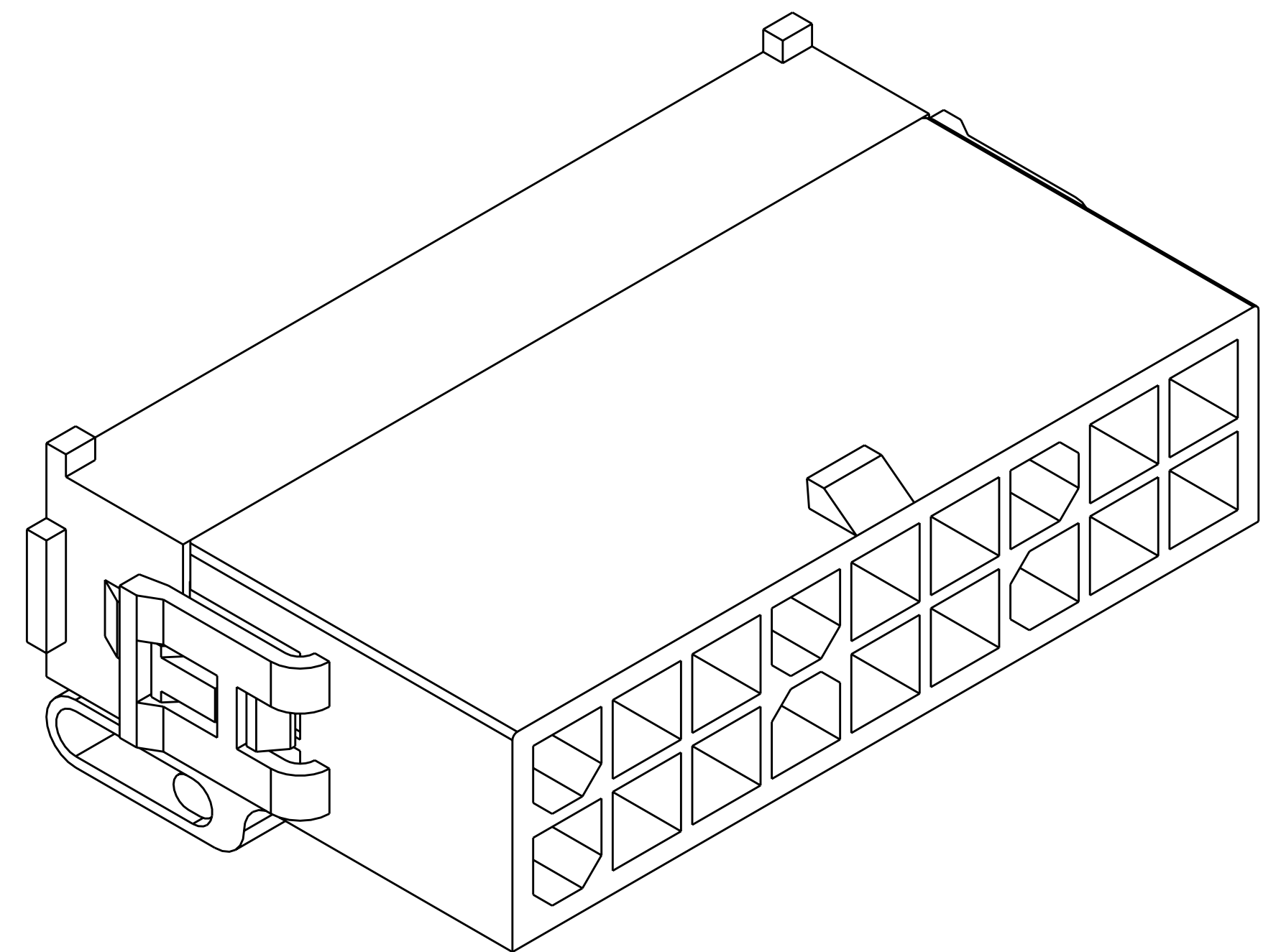
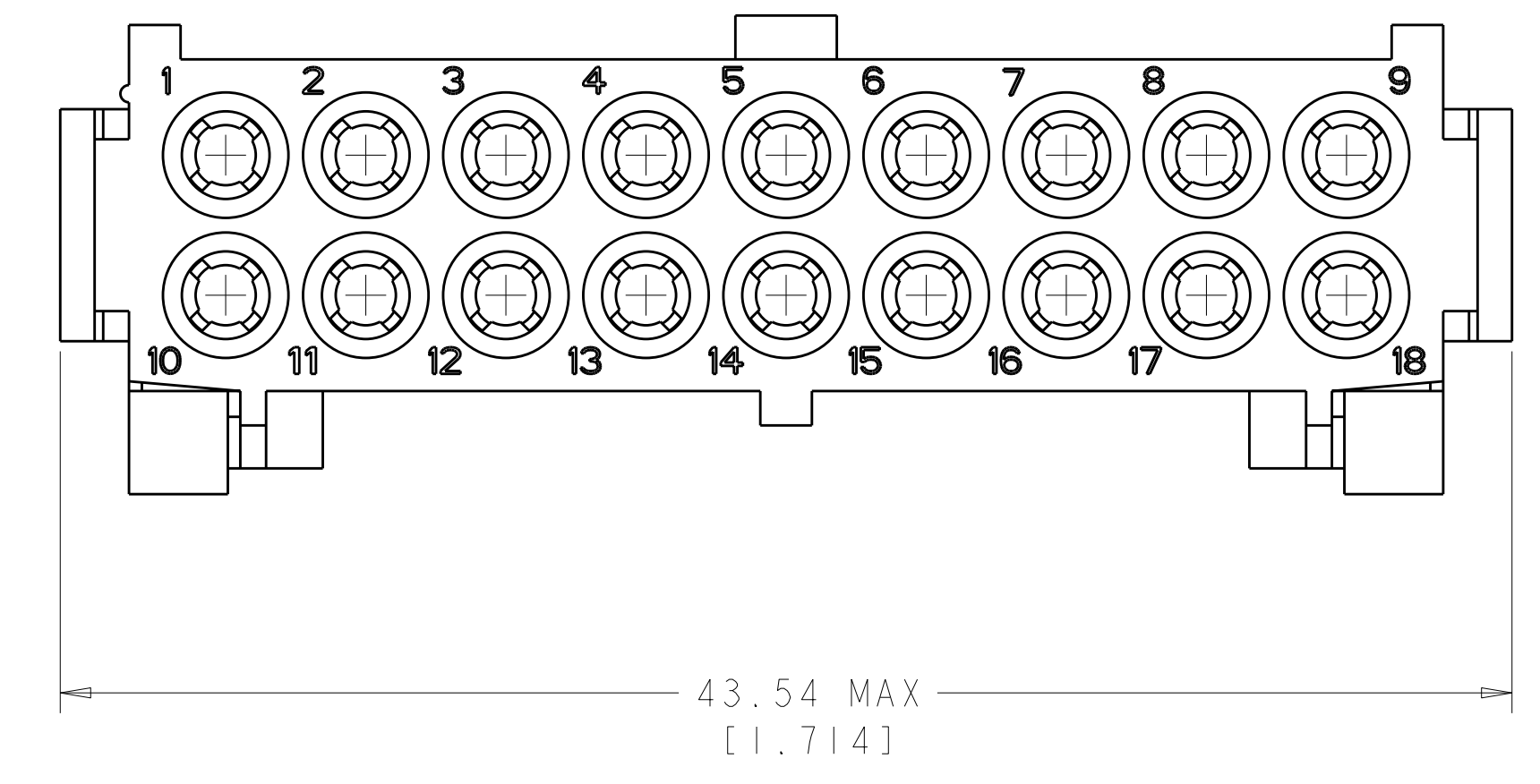
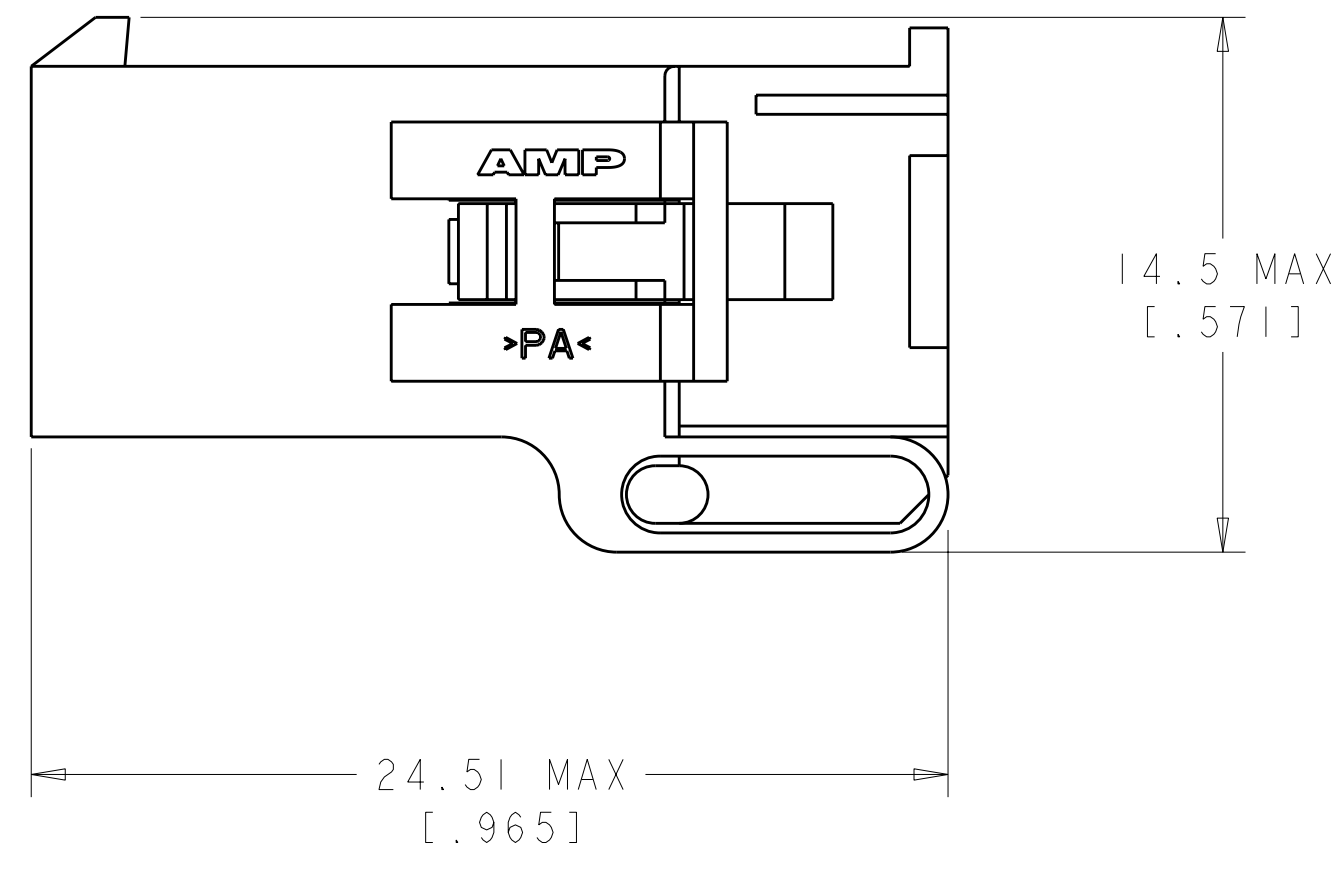
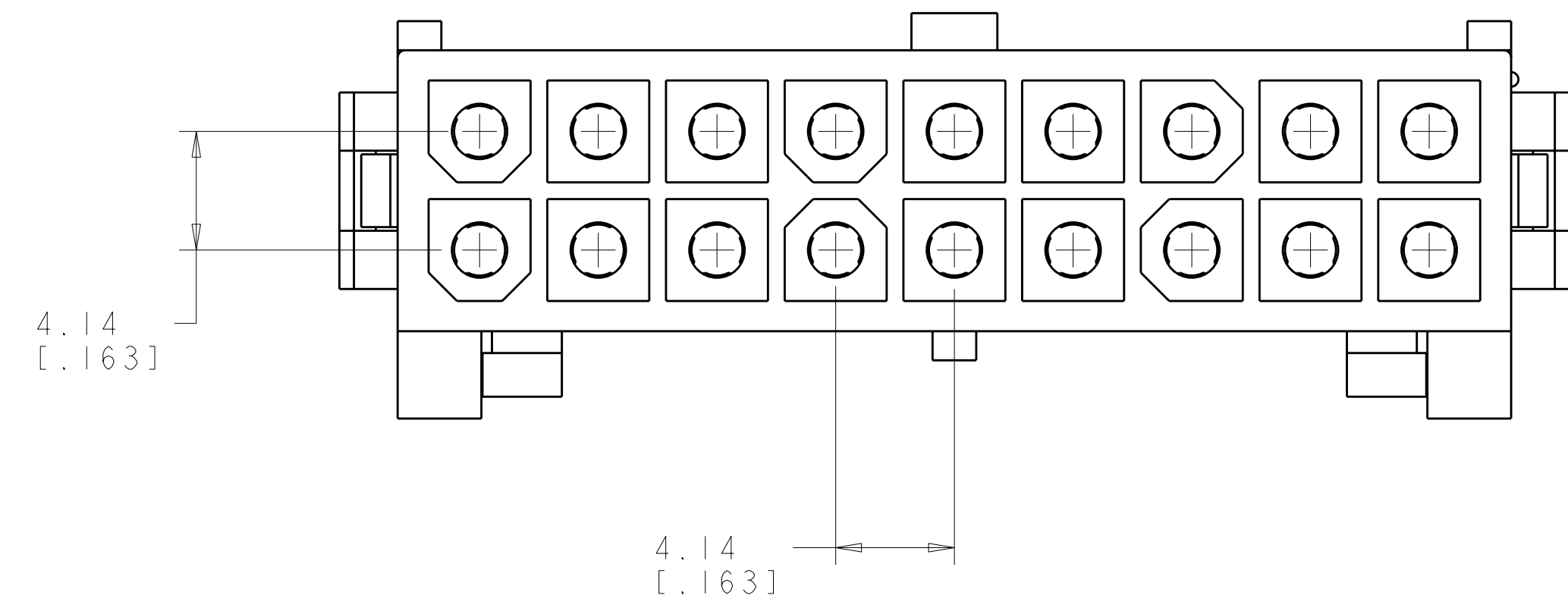

0.334 IN <sup>3</sup>	794209-1
VOLUME	PART NUMBER

<small>THIS DRAWING IS UNPUBLISHED. RELEASED FOR PUBLICATION. ALL RIGHTS RESERVED. THIS DRAWING IS UNPUBLISHED. RELEASED FOR PUBLICATION. ALL RIGHTS RESERVED. THIS DRAWING IS UNPUBLISHED. RELEASED FOR PUBLICATION. ALL RIGHTS RESERVED.</small>		DWN: R. WHITAKER 01AUG2007 CHK: C. JONES 01AUG2007 APVD: C. JONES 01AUG2007	Tyco Electronics Harrisburg, PA 17105-3608
DIMENSIONS: mm [INCHES] TOLERANCES UNLESS OTHERWISE SPECIFIED: 9 PLC ± 8 PLC ±0.13 (1.005) 5 PLC ± 4 PLC ± ANGLES ±0°30'		NAME: CAP. PRODUCT SPEC: DUAL ROW, 18' CIRCUIT, APPLICATION SPEC: MINI UNIVERSAL MATE-N-LOK(TM) 2	SIZE: A CAGE CODE: 00779 DRAWING NO: C=794209
MATERIAL: NYLON UL 94V-0, NATURAL		FINISH: - WEIGHT: - CUSTOMER DRAWING	RESTRICTED TO: - SCALE: 5:1 SHEET: 1 OF 1 REV: A1

