

Dimensions mm[inch]
tolerances according to DIN ISO 2768-m
Toleranzen gem. DIN ISO 2768-m

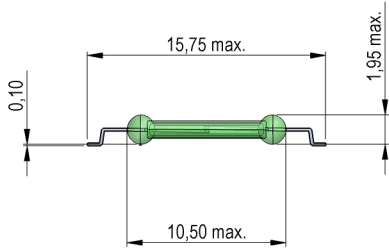

Isometric
Scale 2:1
Maßstab 2:1

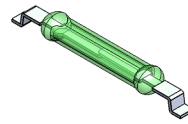

Recommended PCB Pad Layout

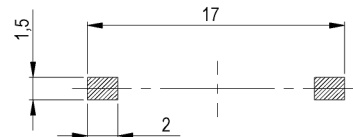
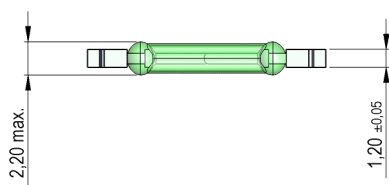

Solder Reflow Profile

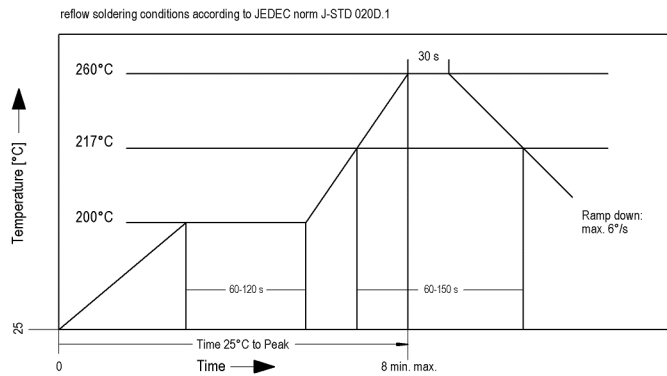

Packaging

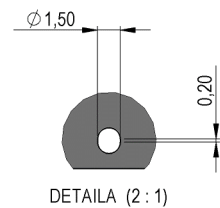
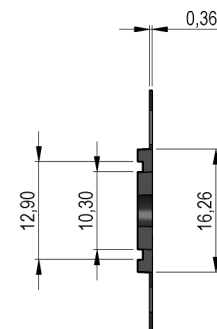
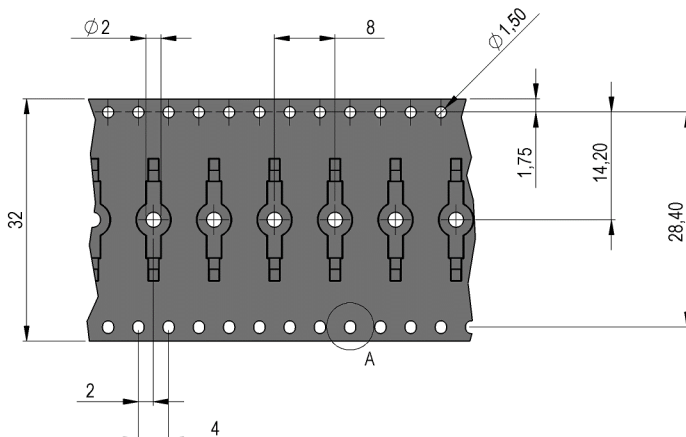



Europe: +49 / 7731 8399 0

| Email: info@standexmeder.com

Item No.:

USA: +1 / 508 295 0771

| Email: salesusa@standexmeder.com

9231350024

Asia: +852 / 2955 1682

| Email: salesasia@standexmeder.com

Item:

MK23-35-D-2

Magnetic properties	Conditions	Min	Typ	Max	Unit
Pull-In	at 20°C	57		80	
Test equipment		KMS-11 + AP51			
Pull-In in milliTesla (modified conta	MS150 - phys. caused tolerance +/- 0,1mT	2,2		3,4	mT
Test equipment		MS-150			

Contact data 35	Conditions	Min	Typ	Max	Unit
Contact - No.		35			
Contact-form		A - NO			
Contact rating	Any DC combination of V & A not to exceed their individual max.'s			15	W
Switching voltage (> 9 AT)	DC or Peak AC			200	V
Switching current	DC or Peak AC			1	A
Carry current	DC or Peak AC			1,25	A
Contact resistance static	Measured with 40% overdrive Start Value			150	mOhm
Breakdown voltage (10-30 AT)	according to IEC 255-5	220			VDC

Special Product Data	Conditions	Min	Typ	Max	Unit
Approval					

Environmental data	Conditions	Min	Typ	Max	Unit
Shock	1/2 sine wave duration 11ms			30	g
Vibration	from 10 - 2000 Hz			20	g
Operating temperature		-40		130	°C
Storage temperature		-55		130	°C
Washability		fully sealed			

Modifications in the sense of technical progress are reserved

Designed at: 07.02.08 Designed by: WKOVACS

Approval at: 24.11.08 Approval by: JHEYDER

Last Change at: 28.05.15 Last Change by: THAUKE

Approval at: 28.05.15 Approval by: JHEYDER

Version: 8