

Features

- Epitaxial Planar Die Construction
- Complementary PNP Type Available (MMST2907A)
- Ultra-Small Surface Mount Package
- Also Available in Lead Free Version

Mechanical Data

- Case: SOT-323, Molded Plastic
- Case Material - UL Flammability Rating 94V-0
- Moisture sensitivity: Level 1 per J-STD-020A
- Terminals: Solderable per MIL-STD-202, Method 208
- Also Available in Lead Free Plating (Matte Tin Finish). Please see Ordering Information, Note 4, on Page 2
- Terminal Connections: See Diagram
- Marking (See Page 2): K3P
- Ordering & Date Code Information: See Page 2
- Weight: 0.006 grams (approx.)

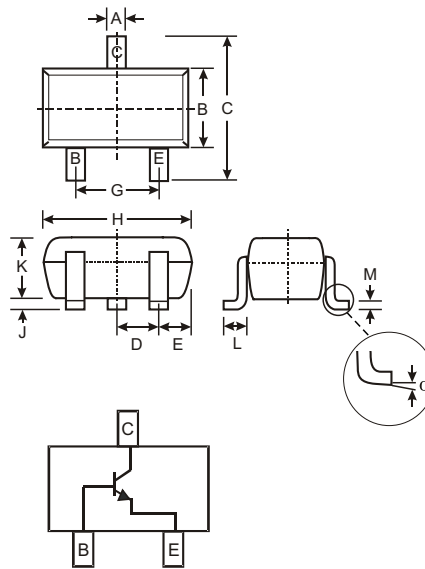

SOT-323		
Dim	Min	Max
A	0.25	0.40
B	1.15	1.35
C	2.00	2.20
D	0.65 Nominal	
E	0.30	0.40
G	1.20	1.40
H	1.80	2.20
J	0.0	0.10
K	0.90	1.00
L	0.25	0.40
M	0.10	0.18
α	0°	8°
All Dimensions in mm		

Maximum Ratings @ $T_A = 25^\circ\text{C}$ unless otherwise specified

Characteristic	Symbol	MMST2222A	Unit
Collector-Base Voltage	V_{CBO}	75	V
Collector-Emitter Voltage	V_{CEO}	40	V
Emitter-Base Voltage	V_{EBO}	6.0	V
Collector Current - Continuous (Note 1)	I_C	600	mA
Power Dissipation (Note 1)	P_d	200	mW
Thermal Resistance, Junction to Ambient (Note 1)	$R_{\theta JA}$	625	$^\circ\text{C}/\text{W}$
Operating and Storage and Temperature Range	T_j, T_{STG}	-55 to +150	$^\circ\text{C}$

Note: 1. Device mounted on FR-4 PCB, 1 inch x 0.85 inch x 0.062 inch; pad layout as shown on Diodes Inc. suggested pad layout document AP02001, which can be found on our website at <http://www.diodes.com/datasheets/ap02001.pdf>.

Electrical Characteristics @ $T_A = 25^\circ\text{C}$ unless otherwise specified

Characteristic	Symbol	Min	Max	Unit	Test Condition
OFF CHARACTERISTICS (Note 2)					
Collector-Base Breakdown Voltage	$V_{(BR)CBO}$	75	—	V	$I_C = 10\mu\text{A}, I_E = 0$
Collector-Emitter Breakdown Voltage	$V_{(BR)CEO}$	40	—	V	$I_C = 10\text{mA}, I_B = 0$
Emitter-Base Breakdown Voltage	$V_{(BR)EBO}$	6.0	—	V	$I_E = 10\mu\text{A}, I_C = 0$
Collector Cutoff Current	I_{CBO}	—	10	nA μA	$V_{CB} = 60\text{V}, I_E = 0$ $V_{CB} = 60\text{V}, I_E = 0, T_A = 150^\circ\text{C}$
Collector Cutoff Current	I_{CEX}	—	10	nA	$V_{CE} = 60\text{V}, V_{EB(OFF)} = 3.0\text{V}$
Emitter Cutoff Current	I_{EBO}	—	10	nA	$V_{EB} = 3.0\text{V}, I_C = 0$
Base Cutoff Current	I_{BL}	—	20	nA	$V_{CE} = 60\text{V}, V_{EB(OFF)} = 3.0\text{V}$
ON CHARACTERISTICS (Note 2)					
DC Current Gain	h_{FE}	35 50 75 100 40 50 35	— — — 300 — — —	—	$I_C = 100\mu\text{A}, V_{CE} = 10\text{V}$ $I_C = 1.0\text{mA}, V_{CE} = 10\text{V}$ $I_C = 10\text{mA}, V_{CE} = 10\text{V}$ $I_C = 150\text{mA}, V_{CE} = 10\text{V}$ $I_C = 500\text{mA}, V_{CE} = 10\text{V}$ $I_C = 10\text{mA}, V_{CE} = 10\text{V}, T_A = -55^\circ\text{C}$ $I_C = 150\text{mA}, V_{CE} = 1.0\text{V}$
Collector-Emitter Saturation Voltage	$V_{CE(SAT)}$	—	0.3 1.0	V	$I_C = 150\text{mA}, I_B = 15\text{mA}$ $I_C = 500\text{mA}, I_B = 50\text{mA}$
Base- Emitter Saturation Voltage	$V_{BE(SAT)}$	0.6 —	1.2 2.0	V	$I_C = 150\text{mA}, I_B = 15\text{mA}$ $I_C = 500\text{mA}, I_B = 50\text{mA}$
SMALL SIGNAL CHARACTERISTICS					
Output Capacitance	C_{obo}	—	8	pF	$V_{CB} = 10\text{V}, f = 1.0\text{MHz}, I_E = 0$
Input Capacitance	C_{ibo}	—	25	pF	$V_{EB} = 0.5\text{V}, f = 1.0\text{MHz}, I_C = 0$
Current Gain-Bandwidth Product	f_T	300	—	MHz	$V_{CE} = 20\text{V}, I_C = 20\text{mA}, f = 100\text{MHz}$
Noise Figure	NF	—	4.0	dB	$V_{CE} = 10\text{V}, I_C = 100\mu\text{A}, R_S = 1.0\text{k}\Omega, f = 1.0\text{kHz}$
SWITCHING CHARACTERISTICS					
Delay Time	t_d	—	10	ns	$V_{CC} = 30\text{V}, I_C = 150\text{mA}, V_{BE(off)} = -0.5\text{V}, I_{B1} = 15\text{mA}$
Rise Time	t_r	—	25	ns	
Storage Time	t_s	—	225	ns	$V_{CC} = 30\text{V}, I_C = 150\text{mA}, I_{B1} = I_{B2} = 15\text{mA}$
Fall Time	t_f	—	60	ns	

Ordering Information (Note 3)

Device	Packaging	Shipping
MMST2222A-7	SOT-323	3000/Tape & Reel

- Notes:
- Short duration test pulse used to minimize self-heating effect.
 - For Packaging Details, go to our website at <http://www.diodes.com/datasheets/ap02007.pdf>.
 - For Lead Free version (with Lead Free terminal finish) part number, please add "-F" suffix to part number above.
Example: MMST2222A-7-F.

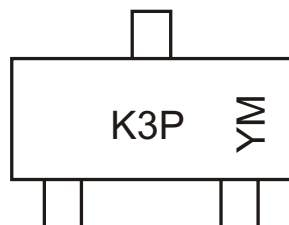
Marking Information

K3P = Product Type Marking Code
 YM = Date Code Marking
 Y = Year ex: N = 2002
 M = Month ex: 9 = September

Date Code Key

Year	1998	1999	2000	2001	2002	2003	2004	2005	2006	2007	2008	2009
Code	J	K	L	M	N	P	R	S	T	U	V	W

Month	Jan	Feb	March	Apr	May	Jun	Jul	Aug	Sep	Oct	Nov	Dec
Code	1	2	3	4	5	6	7	8	9	O	N	D

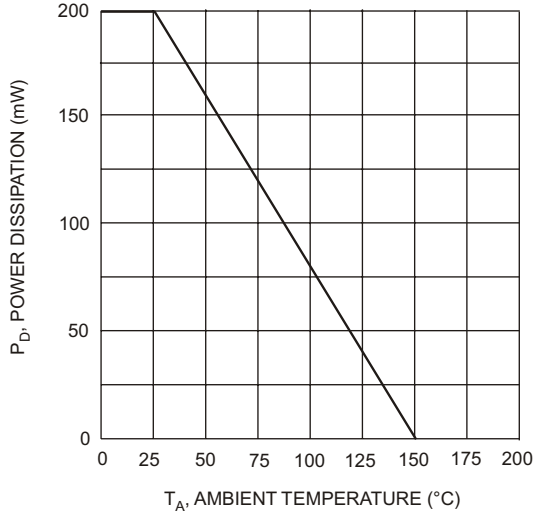

T_A , AMBIENT TEMPERATURE ($^{\circ}\text{C}$)
Fig. 1, Max Power Dissipation vs Ambient Temperature

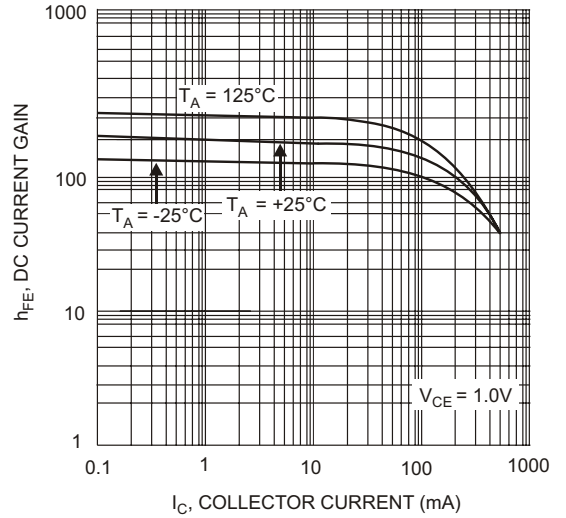

I_C , COLLECTOR CURRENT (mA)
Fig. 2 Typical DC Current Gain vs Collector Current

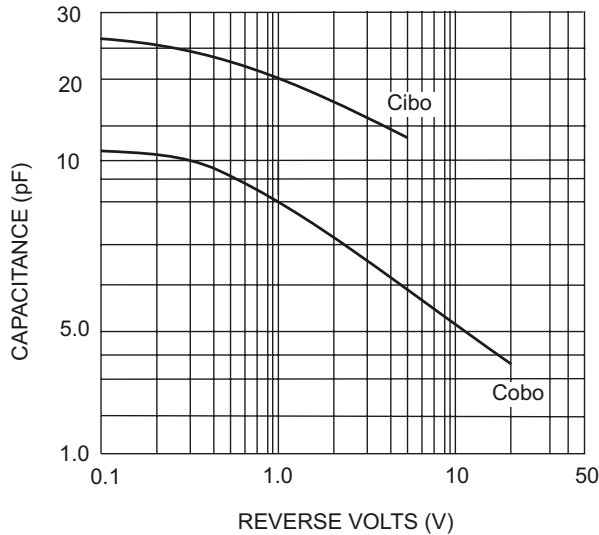

REVERSE VOLTS (V)
Fig. 3 Typical Capacitance

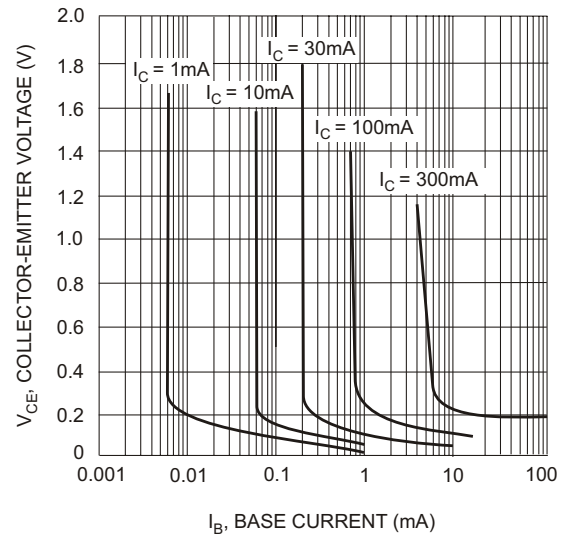

I_B , BASE CURRENT (mA)
Fig. 4 Typical Collector Saturation Region

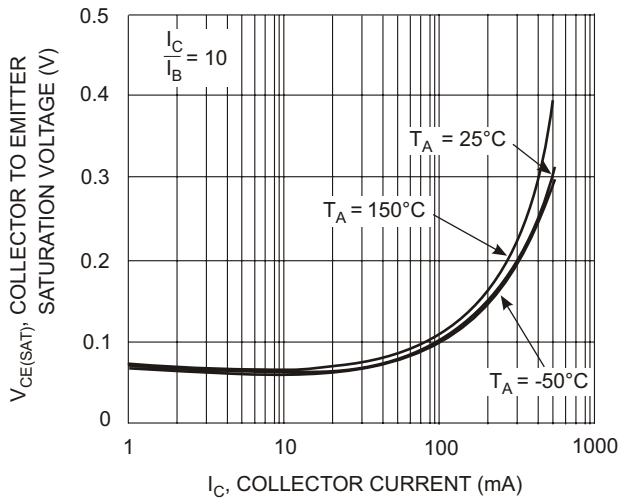

I_C , COLLECTOR CURRENT (mA)
Fig. 5 Collector Emitter Saturation Voltage vs. Collector Current

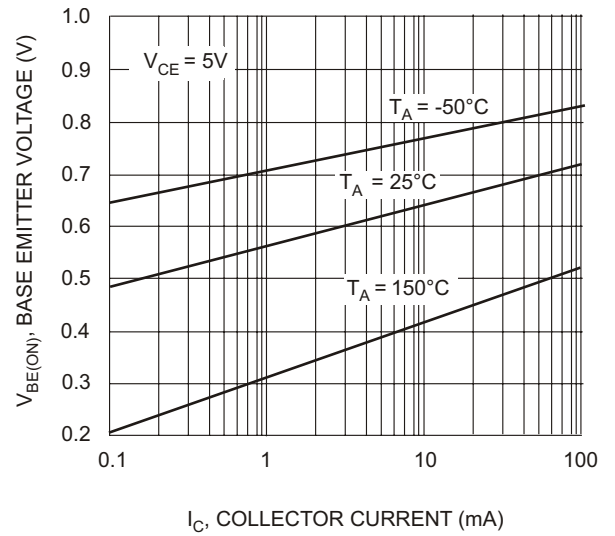

I_C , COLLECTOR CURRENT (mA)
Fig. 6 Base Emitter Voltage vs. Collector Current

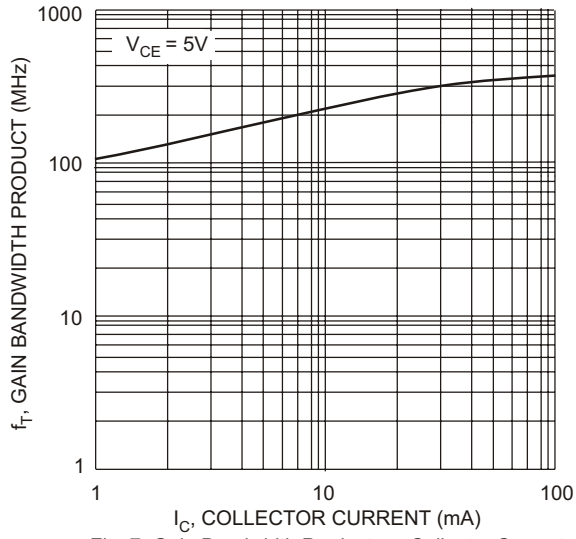

Fig. 7 Gain Bandwidth Product vs. Collector Current