

## OLGA-M

~30° spot beam beam. Assembly with holder and installation tape.

### TECHNICAL SPECIFICATIONS:

Dimensions	Ø 32.0 mm
Height	19.1 mm
Fastening	tape, pin
Colour	black
Box size	476 x 273 x 292 mm
Box weight	9.8 kg
Quantity in Box	792 pcs
ROHS compliant	yes ⓘ



### MATERIAL SPECIFICATIONS:

Component	Type	Material	Colour
OLGA-M	Lens	PMMA	clear
OLGA-HLD	Holder	PC	black
SPUTNIK-TAPE3	Tape	PU tape	black

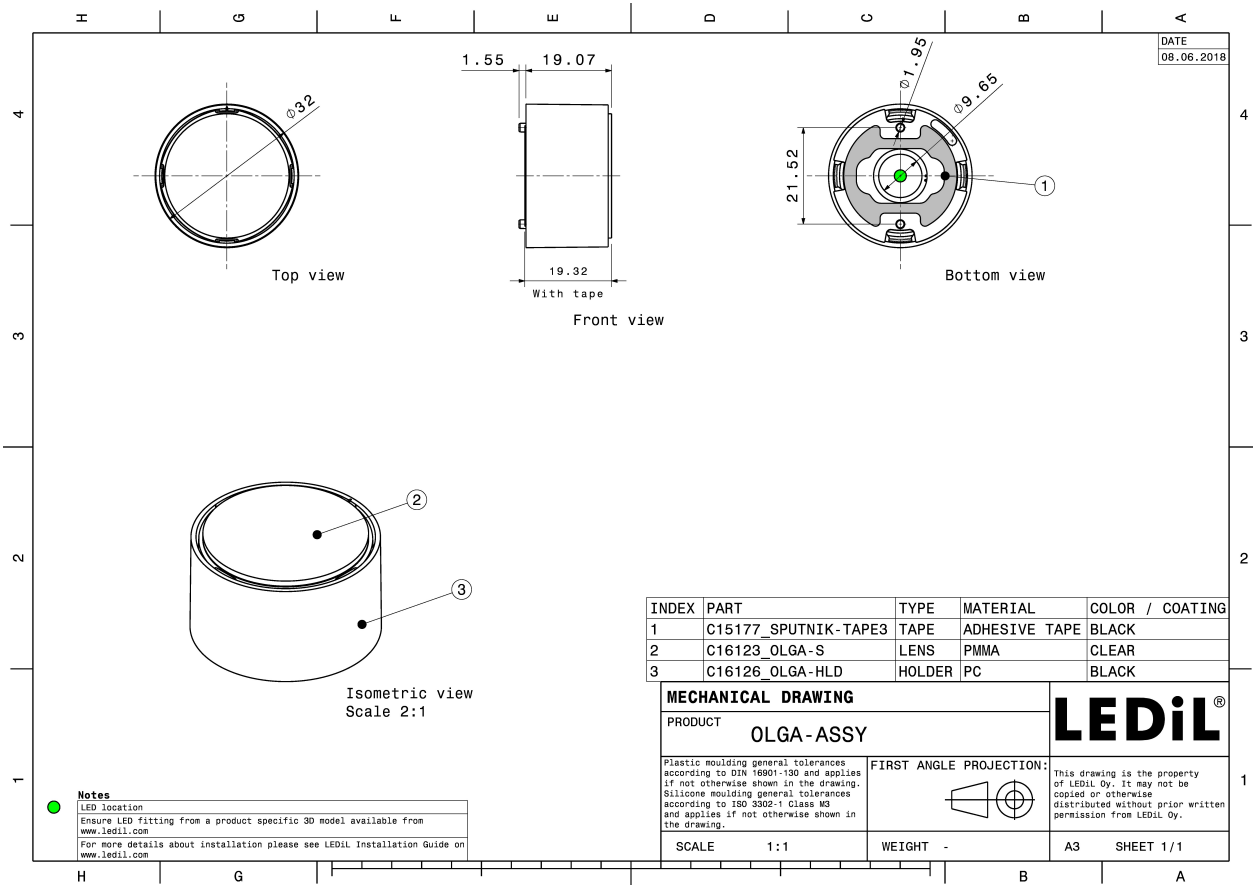

#### PHOTOMETRIC DATA (MEASURED):

**CREE** 

LED XD16  
 FWHM 26.0°  
 Efficiency 80 %  
 Peak intensity 3.200 cd/lm  
 Required components:

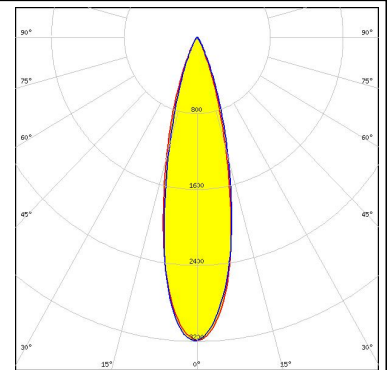

**CREE** 

LED XHP35 HI  
 FWHM 28.0°  
 Efficiency 84 %  
 Peak intensity 2.800 cd/lm  
 Required components:

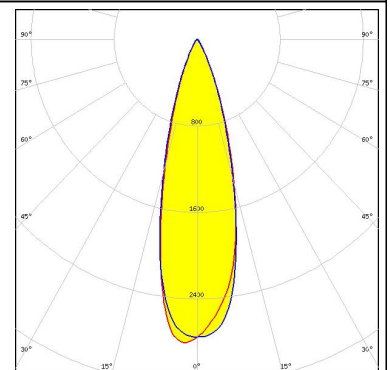
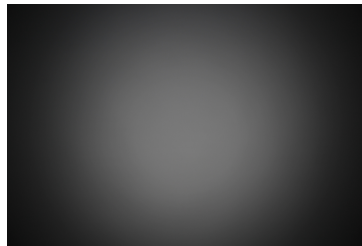

**CREE** 

LED XHP70  
 FWHM 33.0°  
 Efficiency 82 %  
 Peak intensity 2.000 cd/lm  
 Required components:

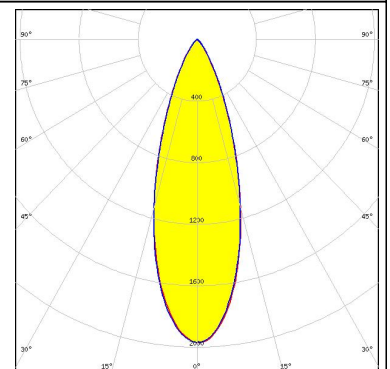
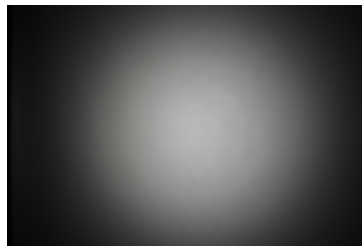

**CREE** 

LED XHP70.2  
 FWHM 34.0°  
 Efficiency 81 %  
 Peak intensity 1.900 cd/lm  
 Required components:

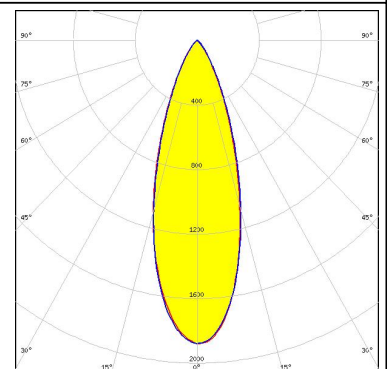
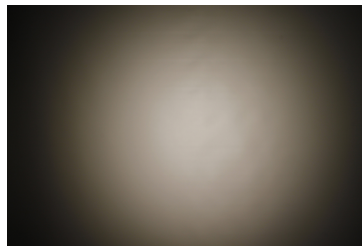

#### PHOTOMETRIC DATA (MEASURED):



LED XP-G2  
 FWHM 30.0°  
 Efficiency 83 %  
 Peak intensity 2.700 cd/lm  
 Required components:

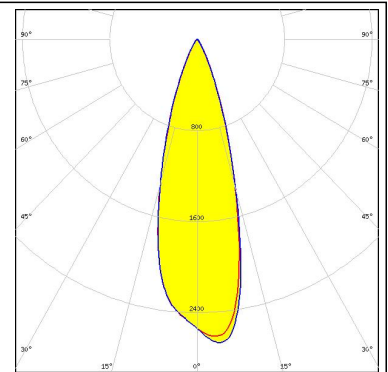
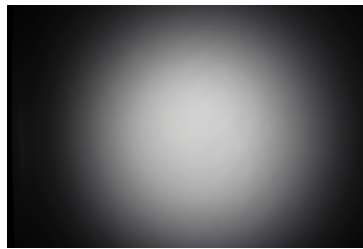

LED XP-L HI  
 FWHM 28.0°  
 Efficiency 85 %  
 Peak intensity 3.000 cd/lm  
 Required components:

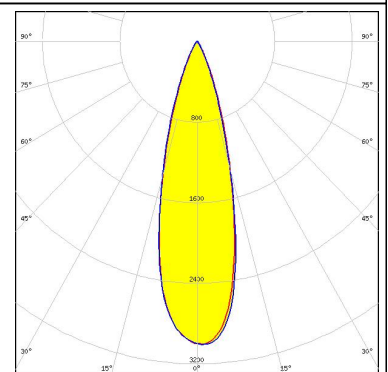

LED XQ-E HI  
 FWHM 27.0°  
 Efficiency 83 %  
 Peak intensity 3.100 cd/lm  
 Required components:

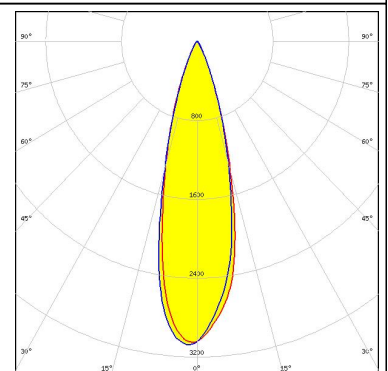
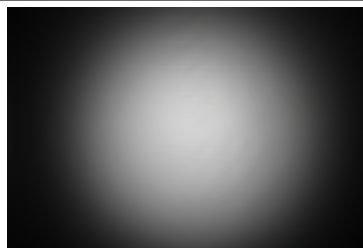

LED LUXEON 5050  
 FWHM 27.0°  
 Efficiency 86 %  
 Peak intensity 3.000 cd/lm  
 Required components:

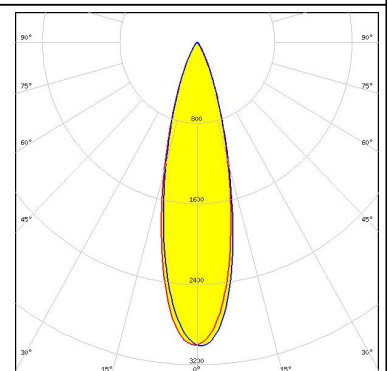
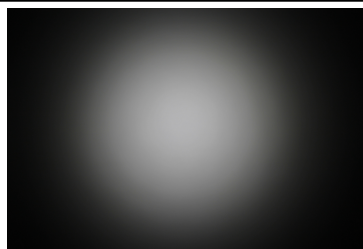

#### PHOTOMETRIC DATA (MEASURED):

##### LUMILEDS

LED LUXEON C  
 FWHM 29.0°  
 Efficiency 76 %  
 Peak intensity 2.600 cd/lm  
 Required components:

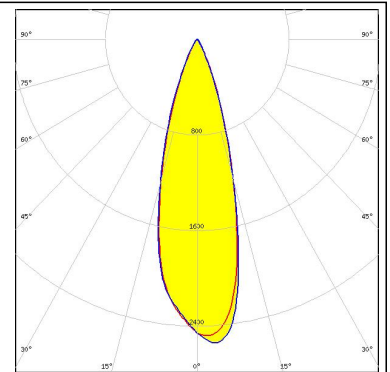
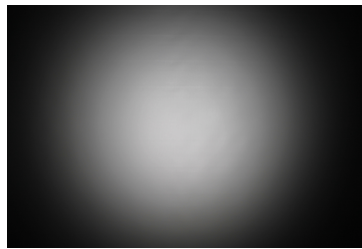

##### LUMILEDS

LED LUXEON CZ  
 FWHM 26.0°  
 Efficiency 85 %  
 Peak intensity 3.500 cd/lm  
 Required components:

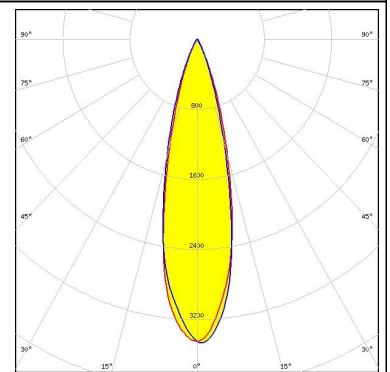
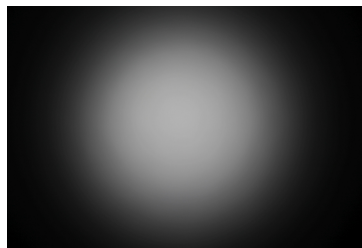

##### LUMILEDS

LED LUXEON M/MX  
 FWHM 31.0°  
 Efficiency 84 %  
 Peak intensity 2.300 cd/lm  
 Required components:

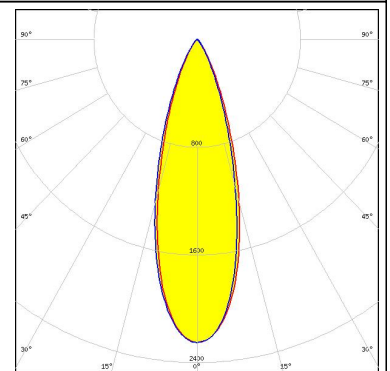
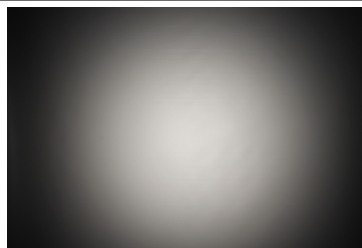

##### LUMILEDS

LED LUXEON V  
 FWHM 29.0°  
 Efficiency 82 %  
 Peak intensity 2.600 cd/lm  
 Required components:

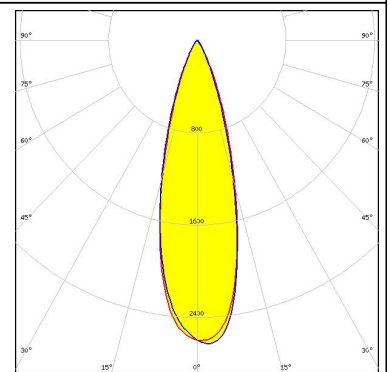
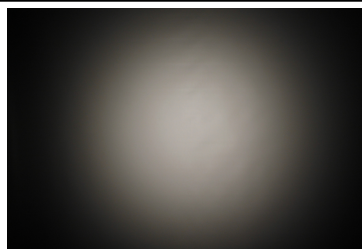

### PHOTOMETRIC DATA (MEASURED):



LED LUXEON V  
FWHM 28.0°  
Efficiency 82 %  
Peak intensity 2.700 cd/lm  
Required components:

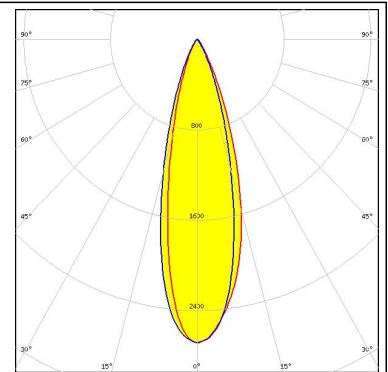

LED NVSW219D  
FWHM 31.0°  
Efficiency 83 %  
Peak intensity 2.400 cd/lm  
Required components:

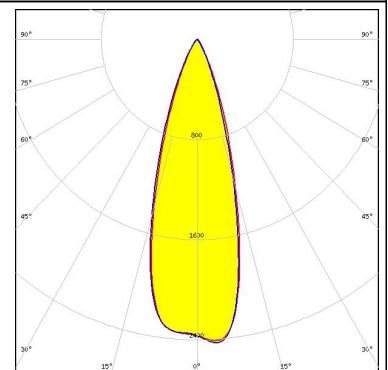
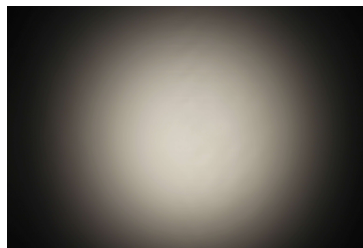

LED Duris S8  
FWHM 27.0°  
Efficiency 85 %  
Peak intensity 2.950 cd/lm  
Required components:

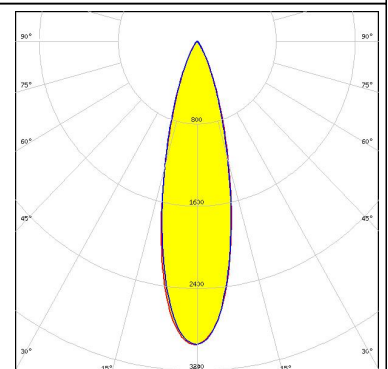
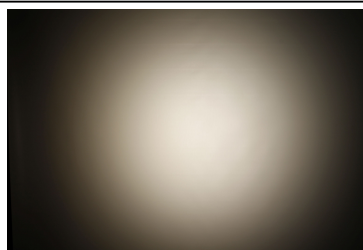

LED Oslon Black Flat  
FWHM 24.0°  
Efficiency 85 %  
Peak intensity 3.900 cd/lm  
Required components:

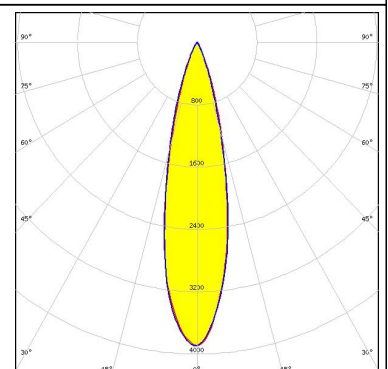
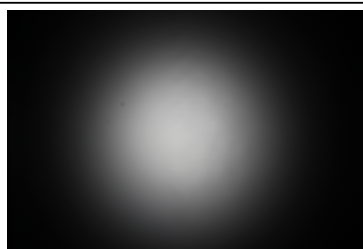

**PHOTOMETRIC DATA (MEASURED):**

**OSRAM**  
Opto Semiconductors

LED Oslon Square EC  
FWHM 28.0°  
Efficiency 81 %  
Peak intensity 2.900 cd/lm  
Required components:

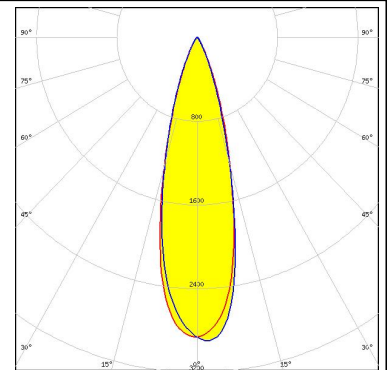

**OSRAM**  
Opto Semiconductors

LED Oslon Square Gen3  
FWHM 30.0°  
Efficiency 84 %  
Peak intensity 2.700 cd/lm  
Required components:

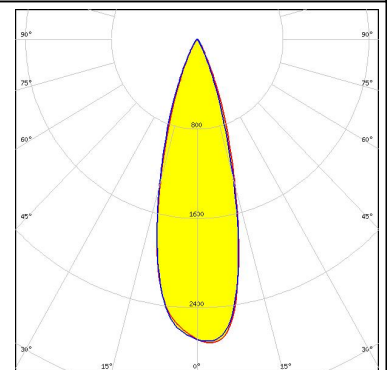
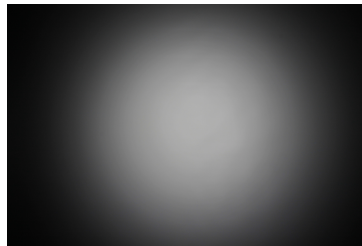

**OSRAM**  
Opto Semiconductors

LED Oslon SSL 150  
FWHM 30.0°  
Efficiency 82 %  
Peak intensity 2.700 cd/lm  
Required components:

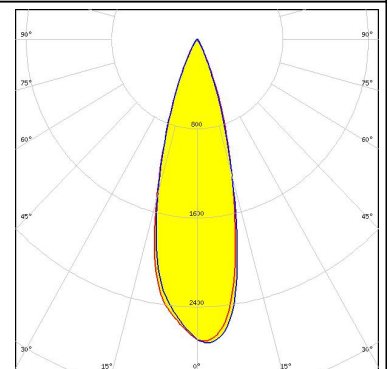
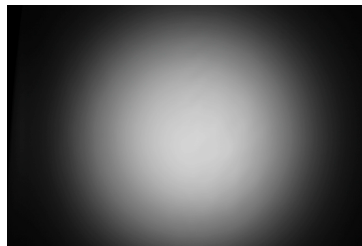

**SAMSUNG**

LED LH181B  
FWHM 23.0°  
Efficiency 85 %  
Peak intensity 3.400 cd/lm  
Required components:

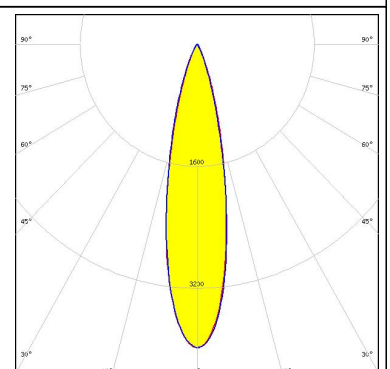

### PHOTOMETRIC DATA (MEASURED):

#### SAMSUNG

LED LH351B  
FWHM 30.0°  
Efficiency 84 %  
Peak intensity 2.700 cd/lm  
Required components:

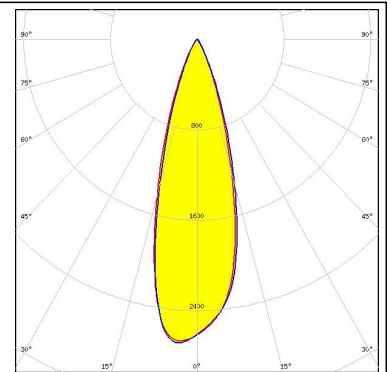

#### SAMSUNG

LED LM302A  
FWHM 25.0°  
Efficiency 85 %  
Peak intensity 3.400 cd/lm  
Required components:

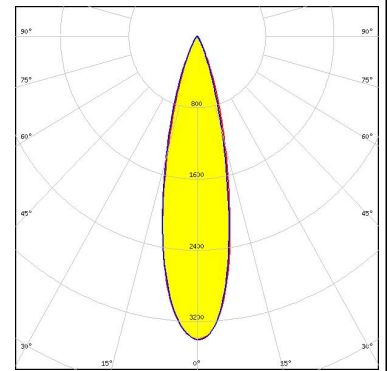
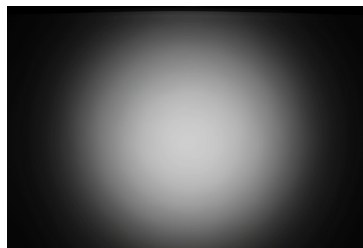



### PHOTOMETRIC DATA (SIMULATED):

#### CITIZEN

LED PSL440  
FWHM 26.0°  
Efficiency 87 %  
Peak intensity 3.780 cd/lm  
Required components:

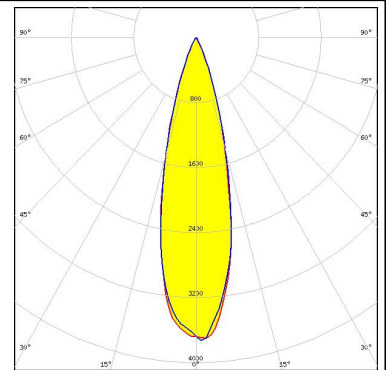

#### CITIZEN

LED PSL445  
FWHM 30.0°  
Efficiency 89 %  
Peak intensity 2.780 cd/lm  
Required components:

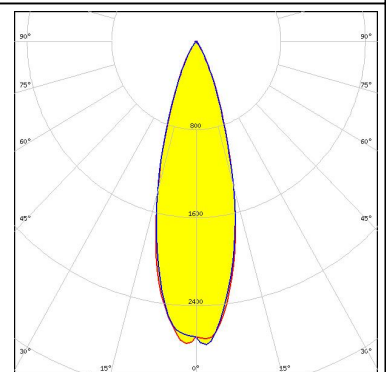

#### CREE

LED XHP50  
FWHM 28.0°  
Efficiency 91 %  
Peak intensity 3.549 cd/lm  
Required components:

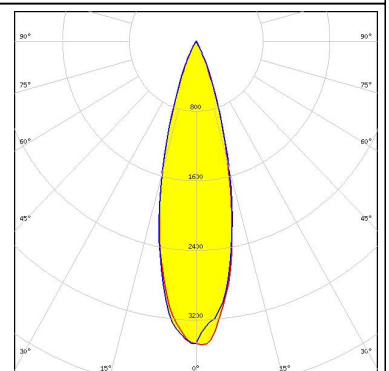

#### LUMILEDS

LED LUXEON MZ  
FWHM 22.0°  
Efficiency 91 %  
Peak intensity 5.407 cd/lm  
Required components:

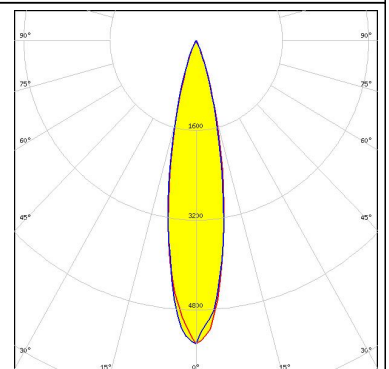

### PHOTOMETRIC DATA (SIMULATED):



LED NFMW48xA  
FWHM 25.0°  
Efficiency 92 %  
Peak intensity 4.300 cd/lm  
Required components:

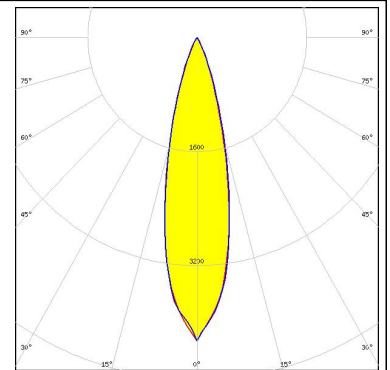

LED NV4x144A  
FWHM 31.0°  
Efficiency 86 %  
Peak intensity 2.740 cd/lm  
Required components:

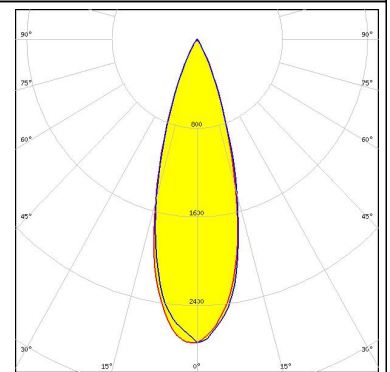

### GENERAL INFORMATION:

NOTE: The typical beam angle will be changed by different color, chip size and chip position tolerance. The typical total beam angle is the full angle measured where the luminous intensity is half of the peak value.

### MATERIALS:

As part of our continuous research and improvement processes, and to ensure the best possible quality and availability of our products, LEDiL reserves the right to change material grades without notice.

### PRODUCT DATA USER AGREEMENT AND DISCLAIMER:

The measured data in the provided downloadable LEDiL Product Datasheets and Mechanical 2D-Drawings is rounded and provided as reference for planning. LEDiL Oy's optical specifications have been verified by conducting performance testing of the products in accordance with the company's quality system. The reported data are averaged results of multiple measurements with typical variation. LEDiL Oy reserves the right to without prior notification make changes and improvements to its products.

LEDiL Oy assumes neither warranty, nor guarantee nor any other liability of any kind for the contents and correctness of the provided data. The provided data has been generated with highest diligence but the provided data may in reality not represent the complete possible variation range of all intrinsic parameters. Therefore, in certain cases a deviation from the provided data could occur.

LEDiL Oy reserves the right to undertake technical changes of its products without further notification which could lead to changes in the provided data. LEDiL Oy assumes no liability of any kind for the possible deviation from any provided data or any other damage resulting from the usage of the provided data.

The user agrees to this disclaimer and user agreement with the download or usage of the provided files.

#### LEDiL Oy

Joensuunkatu 13  
FI-24240 SALO  
Finland

#### LEDiL Inc.

228 West Page Street  
Suite D  
Sycamore IL 60178  
USA

#### Local sales and technical support

[www.ledil.com/  
where\\_to\\_buy](http://www.ledil.com/where_to_buy)

#### Shipping locations

Salo, Finland  
Hong Kong, China

#### Distribution Partners

[www.ledil.com/  
where\\_to\\_buy](http://www.ledil.com/where_to_buy)