

CM6304

EMI Filters with ESD Protection for SIM Card Applications

Product Description

The CM6304 is a 3 x 3, 8-bump EMI filter with ESD protection device for SIM card applications in a 0.4 mm pitch CSP form factor. It is fully compliant with IEC 61000-4-2. The CM6304 is also RoHS II compliant.

Table 1. PIN DESCRIPTIONS

8-bump CSP Package	
Pin	Description
A2	Channel 1 External
A3	Channel 1 Internal
B1	Channel 2 External
B2	GND
B3	Channel 2 Internal
C1	Channel 3 External
C2	V External
C3	Channel 3 Internal



ON Semiconductor®

<http://onsemi.com>



WLCSP8
CASE 567CF

MARKING DIAGRAM

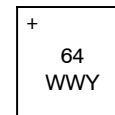

64 = CM6304
WWY = Date Code

PACKAGE / PINOUT DIAGRAMS

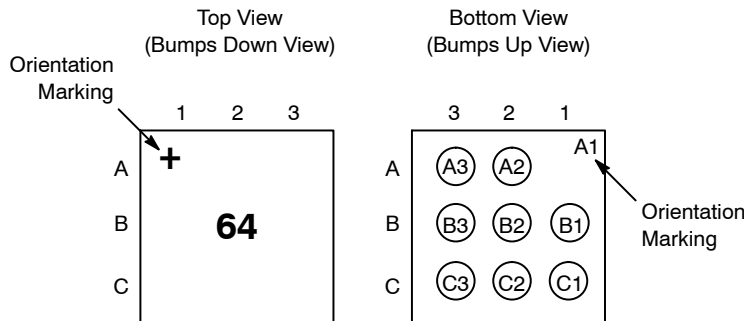

ELECTRICAL SCHEMATIC

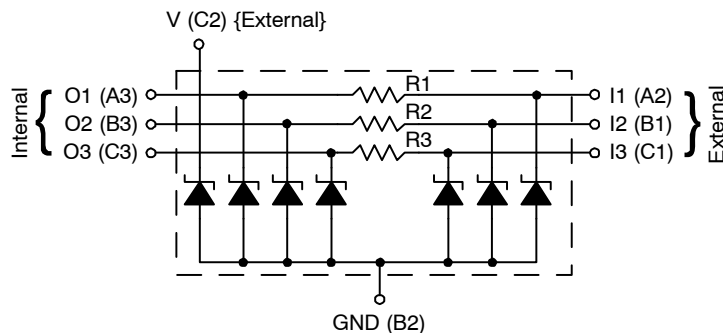

ORDERING INFORMATION

Device	Package	Shipping†
CM6304	CSP-8 (Pb-Free)	5000/Tape & Reel

†For information on tape and reel specifications, including part orientation and tape sizes, please refer to our Tape and Reel Packaging Specification Brochure, BRD8011/D.

CM6304

ELECTRICAL SPECIFICATIONS AND CONDITIONS

Table 2. PARAMETERS AND OPERATING CONDITIONS

Parameter	Rating	Units
Storage Temperature Range	-55 to +150	°C
Operating Temperature Range	-40 to +85	°C

Table 3. ELECTRICAL OPERATING CHARACTERISTICS (Note 1)

Symbol	Parameter	Conditions	Min	Typ	Max	Units
R ₁	Resistance		80	100	120	Ω
R ₂	Resistance		37.6	47	56.4	Ω
R ₃	Resistance		80	100	120	Ω
C	Capacitance on filter channels 1, 2 and 3	At 1 MHz, V _{IN} = 0 V	13.4	16.7	20	pF
	Capacitance on clamp channel (pin C2)	At 1 MHz, V _{IN} = 0 V	8.2	10.3	12.4	pF
V _B	Breakdown Voltage (Positive)	I _F = 8 mA	6	6.8	20	V
V _{ESD}	ESD Protection Peak Discharge Voltage at A2, B1 and C1 pins a) Contact Discharge per IEC 61000-4-2 standard b) Air Discharge per IEC 61000-4-2 standard	(Note 2)	±15 ±15			kV
	ESD Protection Peak Discharge Voltage at C2 pin a) Contact Discharge per IEC 61000-4-2 standard b) Air Discharge per IEC 61000-4-2 standard	(Note 2)	±15 ±15			kV
	ESD Protection Peak Discharge Voltage at A3, B3 and C3 pins a) Contact Discharge per IEC 61000-4-2 standard b) Air Discharge per IEC 61000-4-2 standard	(Note 2)	±4 ±4			kV

1. All parameters specified at T_A = 25°C unless otherwise noted.
2. Standard IEC 61000-4-2 with C_{Discharge} = 150 pF, R_{Discharge} = 330 Ω.

CM6304

RF CHARACTERISTICS

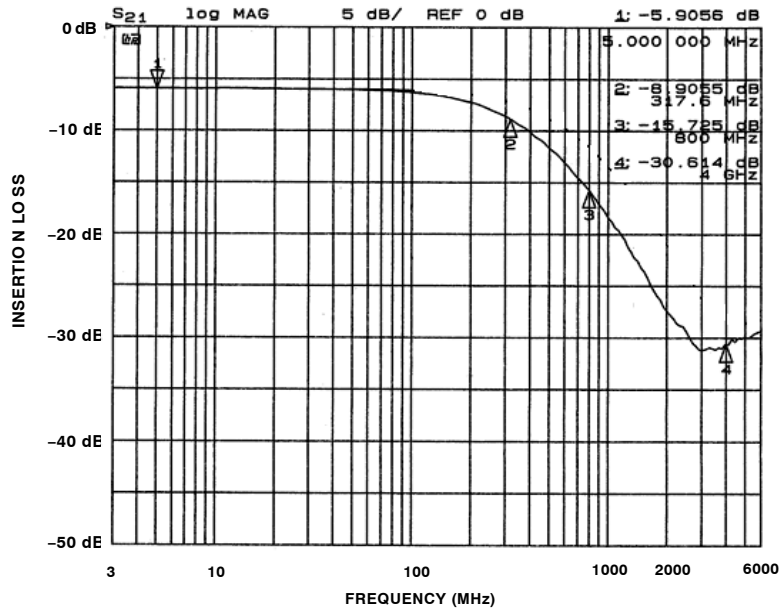

Figure 1. Insertion Loss, Filter 1 (pins A2, A3) and Filter 3 (pins C1, C3) (Bias = 0 V, $T_A = 25^\circ\text{C}$)

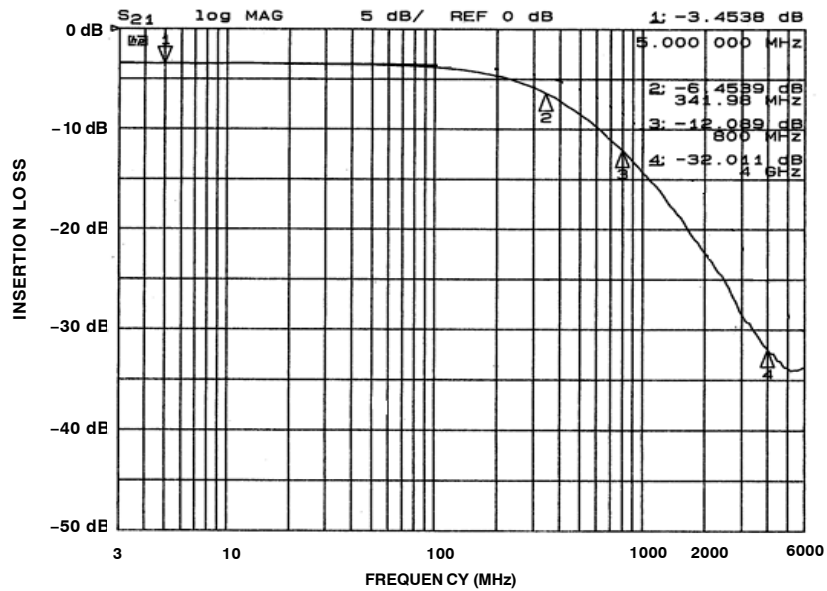
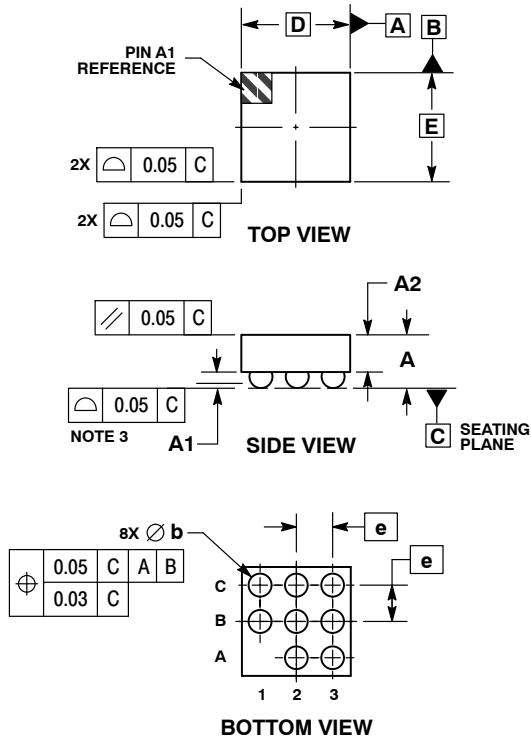

Figure 2. Insertion Loss, Filter 2 (pins B1, B3) (Bias = 0 V, $T_A = 25^\circ\text{C}$)

CM6304

PACKAGE DIMENSIONS

WLCSP8, 1.2x1.2
CASE 567CF-01
ISSUE O



NOTES:

1. DIMENSIONING AND TOLERANCING PER ASME Y14.5M, 1994.
2. CONTROLLING DIMENSION: MILLIMETERS.
3. COPLANARITY APPLIES TO SPHERICAL CROWNS OF SOLDER BALLS.

MILLIMETERS		
DIM	MIN	MAX
A	0.57	0.63
A1	0.17	0.24
A2	0.41 REF	
b	0.24	0.29
D	1.20 BSC	
E	1.20 BSC	
e	0.40 BSC	

RECOMMENDED SOLDERING FOOTPRINT*

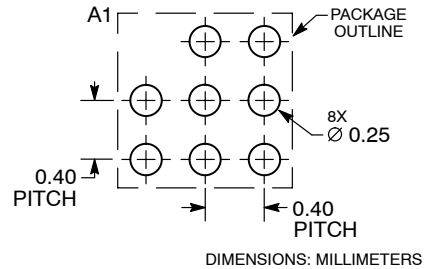

*For additional information on our Pb-Free strategy and soldering details, please download the ON Semiconductor Soldering and Mounting Techniques Reference Manual, SOLDERRM/D.

ON Semiconductor and are registered trademarks of Semiconductor Components Industries, LLC (SCILLC). SCILLC reserves the right to make changes without further notice to any products herein. SCILLC makes no warranty, representation or guarantee regarding the suitability of its products for any particular purpose, nor does SCILLC assume any liability arising out of the application or use of any product or circuit, and specifically disclaims any and all liability, including without limitation special, consequential or incidental damages. "Typical" parameters which may be provided in SCILLC data sheets and/or specifications can and do vary in different applications and actual performance may vary over time. All operating parameters, including "Typicals" must be validated for each customer application by customer's technical experts. SCILLC does not convey any license under its patent rights nor the rights of others. SCILLC products are not designed, intended, or authorized for use as components in systems intended for surgical implant into the body, or other applications intended to support or sustain life, or for any other application in which the failure of the SCILLC product could create a situation where personal injury or death may occur. Should Buyer purchase or use SCILLC products for any such unintended or unauthorized application, Buyer shall indemnify and hold SCILLC and its officers, employees, subsidiaries, affiliates, and distributors harmless against all claims, costs, damages, and expenses, and reasonable attorney fees arising out of, directly or indirectly, any claim of personal injury or death associated with such unintended or unauthorized use, even if such claim alleges that SCILLC was negligent regarding the design or manufacture of the part. SCILLC is an Equal Opportunity/Affirmative Action Employer. This literature is subject to all applicable copyright laws and is not for resale in any manner.

PUBLICATION ORDERING INFORMATION

LITERATURE FULFILLMENT:
Literature Distribution Center for ON Semiconductor
P.O. Box 5163, Denver, Colorado 80217 USA
Phone: 303-675-2175 or 800-344-3860 Toll Free USA/Canada
Fax: 303-675-2176 or 800-344-3867 Toll Free USA/Canada
Email: orderlit@onsemi.com

N. American Technical Support: 800-282-9855 Toll Free USA/Canada
Europe, Middle East and Africa Technical Support:
Phone: 421 33 790 2910
Japan Customer Focus Center
Phone: 81-3-5773-3850

ON Semiconductor Website: www.onsemi.com
Order Literature: <http://www.onsemi.com/orderlit>
For additional information, please contact your local Sales Representative