

THESE DRAWINGS ARE THE PROPERTY OF QUALTEK ELECTRONICS AND NOT TO BE REPRODUCED FOR OR COMMUNICATED TO A THIRD PARTY WITHOUT THE EXPRESS WRITTEN PERMISSION OF AN OFFICER OF QUALTEK ELECTRONICS.

REVISION			
REV.	DESCRIPTION	DATE	APPROVED
B	RoHS Compliancy	06-01-06	DP

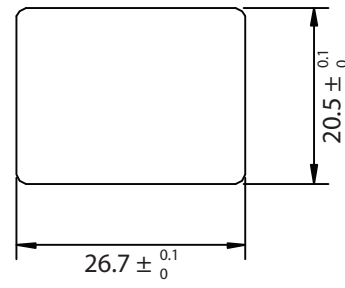

PANEL CUTOUT

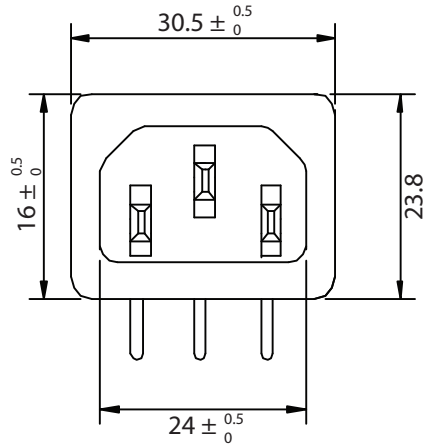
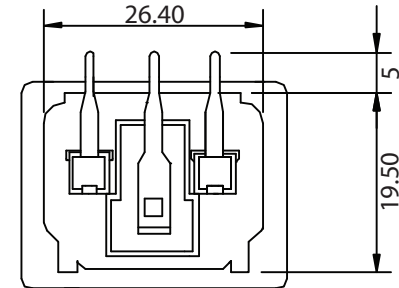
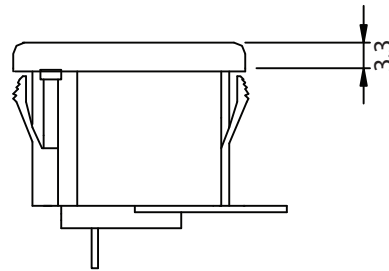
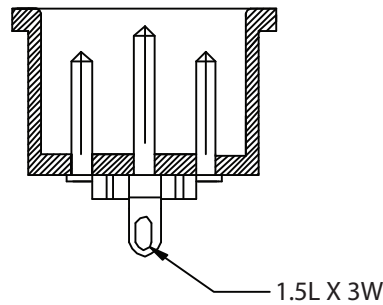
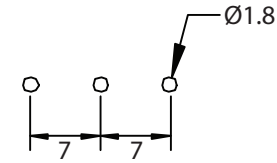

CONTROLLED

NOTES:

RATING:

UL, CSA: 15A 250V AC

VDE: 10A 250V AC

APPROVALS: UL, CSA, VDE

PANEL THICKNESS: 0.8mm~1.5mm

RoHS COMPLIANT

Dim range (mm)	Tolerance +/- (mm)	Qualtek Electronics Corp. PPC DIVISION		
		Part Number:	701W-X2/09	RoHS Compliant
0-1	0.15	Description: AC RECEPTACLE		
1-6	0.20			
6-18	0.30	UNIT: mm	REV. B	
18-50	0.50		Approved / Date	
50-120	0.70	Drawn / Date	Checked / Date	Approved / Date
120-250	0.90	B.Zhang 04-16-02	04-16-02	JJH / 04-16-02
250-500	1.20			