

CRD1611A-8W

8 Watt Reference Design

Features

- Quasi-resonant Flyback with Constant-current Output
- Flicker-free Dimming
- Line Voltage 230VAC, ±10%
- Rated Input Power: 8.0W
- Rated Output Power: 6.6W
- Output Voltage: 11.0V to 12.6V
- Efficiency: 83% at 550mA for 4×LEDs in Series
- Low Component Count
- Supports Cirrus Logic Product CS1611A

General Description

The CRD1611A-8W reference design demonstrates the performance of the CS1611A resonant mode AC/DC dimmable LED driver IC with a 550mA output driving 4×LEDs in series. It offers best-in-class dimmer compatibility with leading-edge, trailing-edge, center-cut, and digital dimmers. The form factor is targeted to fit into many LED bulb applications (A19, PAR).

DIMENSIONS (OVERALL)

Length	Width	Height
2.284" (58mm)	× 1.181" (29.9mm)	× 0.652" (16.5mm)

For more information, see Figure 3 on page 6.

ORDERING INFORMATION

CRD1611A-8W-Z 8 Watt Reference Design
Supports CS1611A

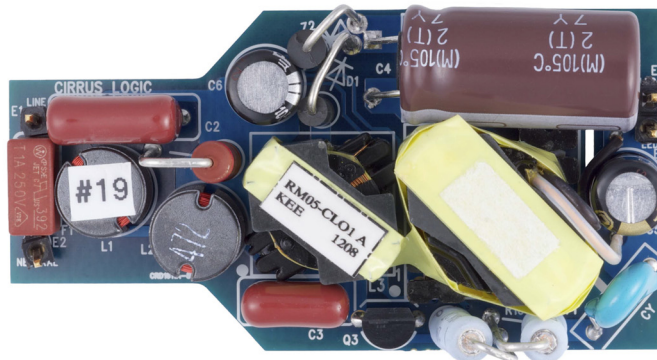

Top

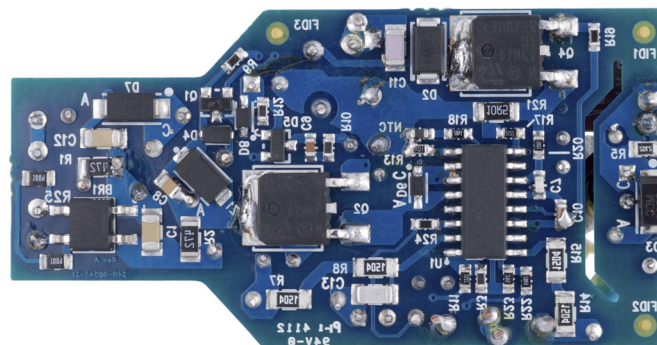

Bottom



IMPORTANT SAFETY INSTRUCTIONS

Read and follow all safety instructions prior to using this demonstration board.

This Engineering Evaluation Unit or Demonstration Board must only be used for assessing IC performance in a laboratory setting. This product is not intended for any other use or incorporation into products for sale.

This product must only be used by qualified technicians or professionals who are trained in the safety procedures associated with the use of demonstration boards.

DANGER Risk of Electric Shock

- The direct connection to the AC power line and the open and unprotected boards present a serious risk of electric shock and can cause serious injury or death. Extreme caution needs to be exercised while handling this board.
- Avoid contact with the exposed conductor or terminals of components on the board. High voltage is present on exposed conductor and it may be present on terminals of any components directly or indirectly connected to the AC line.
- Dangerous voltages and/or currents may be internally generated and accessible at various points across the board.
- Charged capacitors store high voltage, even after the circuit has been disconnected from the AC line.
- Make sure that the power source is off before wiring any connection. Make sure that all connectors are well connected before the power source is on.
- Follow all laboratory safety procedures established by your employer and relevant safety regulations and guidelines, such as the ones listed under, OSHA General Industry Regulations - Subpart S and NFPA 70E.

 **WARNING** Suitable eye protection must be worn when working with or around demonstration boards. Always comply with your employer's policies regarding the use of personal protective equipment.

 **WARNING** All components and metallic parts may be extremely hot to touch when electrically active.

Contacting Cirrus Logic Support

For all product questions and inquiries contact a Cirrus Logic Sales Representative. To find the one nearest to you go to www.cirrus.com

IMPORTANT NOTICE

Cirrus Logic, Inc. and its subsidiaries ("Cirrus") believe that the information contained in this document is accurate and reliable. However, the information is subject to change without notice and is provided "AS IS" without warranty of any kind (express or implied). Customers are advised to obtain the latest version of relevant information to verify, before placing orders, that information being relied on is current and complete. All products are sold subject to the terms and conditions of sale supplied at the time of order acknowledgment, including those pertaining to warranty, indemnification, and limitation of liability. No responsibility is assumed by Cirrus for the use of this information, including use of this information as the basis for manufacture or sale of any items, or for infringement of patents or other rights of third parties. This document is the property of Cirrus and by furnishing this information, Cirrus grants no license, express or implied under any patents, mask work rights, copyrights, trademarks, trade secrets or other intellectual property rights. Cirrus owns the copyrights associated with the information contained herein and gives consent for copies to be made of the information only for use within your organization with respect to Cirrus integrated circuits or other products of Cirrus. This consent does not extend to other copying such as copying for general distribution, advertising or promotional purposes, or for creating any work for resale.

CERTAIN APPLICATIONS USING SEMICONDUCTOR PRODUCTS MAY INVOLVE POTENTIAL RISKS OF DEATH, PERSONAL INJURY, OR SEVERE PROPERTY OR ENVIRONMENTAL DAMAGE ("CRITICAL APPLICATIONS"). CIRRUS PRODUCTS ARE NOT DESIGNED, AUTHORIZED OR WARRANTED FOR USE IN PRODUCTS SURGICALLY IMPLANTED INTO THE BODY, AUTOMOTIVE SAFETY OR SECURITY DEVICES, LIFE SUPPORT PRODUCTS OR OTHER CRITICAL APPLICATIONS. INCLUSION OF CIRRUS PRODUCTS IN SUCH APPLICATIONS IS UNDERSTOOD TO BE FULLY AT THE CUSTOMER'S RISK AND CIRRUS DISCLAIMS AND MAKES NO WARRANTY, EXPRESS, STATUTORY OR IMPLIED, INCLUDING THE IMPLIED WARRANTIES OF MERCHANTABILITY AND FITNESS FOR PARTICULAR PURPOSE, WITH REGARD TO ANY CIRRUS PRODUCT THAT IS USED IN SUCH A MANNER. IF THE CUSTOMER OR CUSTOMER'S CUSTOMER USES OR PERMITS THE USE OF CIRRUS PRODUCTS IN CRITICAL APPLICATIONS, CUSTOMER AGREES, BY SUCH USE, TO FULLY INDEMNIFY CIRRUS, ITS OFFICERS, DIRECTORS, EMPLOYEES, DISTRIBUTORS AND OTHER AGENTS FROM ANY AND ALL LIABILITY, INCLUDING ATTORNEYS' FEES AND COSTS, THAT MAY RESULT FROM OR ARISE IN CONNECTION WITH THESE USES.

Cirrus Logic, Cirrus, the Cirrus Logic logo designs, EXL Core, and the EXL Core logo design are trademarks of Cirrus Logic, Inc. All other brand and product names in this document may be trademarks or service marks of their respective owners.

1. INTRODUCTION

The CS1611A is a 230VAC quasi-resonant flyback mode dimmable LED controller IC. The CS1611A uses a digital control algorithm that is optimized for high efficiency and >0.9 power factor over an input voltage range (207VAC to 253VAC). The CS1611A integrates a critical conduction mode (CRM) boost converter that provides power factor correction and dimmer compatibility with a constant output current, quasi-resonant flyback stage. An adaptive dimmer compatibility algorithm controls the boost stage and dimmer compatibility operation mode to enable flicker-free operation to <2% output current with leading-edge, trailing-edge, and digital dimmers.

The CRD1611A-8W board is optimized to deliver low system cost in a high-efficiency, flicker-free, phase-dimmable, solid-state lighting (SSL) solution for incandescent lamp replacement applications. The feedback loop is closed through an integrated digital control system within the IC. The variation in switching frequency also provides a spread-frequency spectrum, thus minimizing the conducted EMI filtering requirements. Protection algorithms such as output open/short, current-sense resistor open/short, and overtemperature thermistors protect the system during abnormal conditions. Details of these features are provided in the CS1610A/11A/12A/13A *TRIAC Dimmable LED Driver IC* data sheet.

The CRD1611A-8W board demonstrates the performance of the CS1611A. This reference board has been designed for an output load of 4×LEDs in series at 550mA (12.0V typical).

This document provides the schematic for the board. It includes oscilloscope screen shots that indicate various operating waveforms. Graphs are also provided that document the performance of the board in terms of Efficiency vs. Line Voltage, Output Current vs. Line Voltage, and Output Current vs. Dim Angle for the CS1611A dimmable LED controller IC.

Extreme caution needs to be exercised while handling this board. This board is to be used by trained professionals only.

2. SCHEMATIC

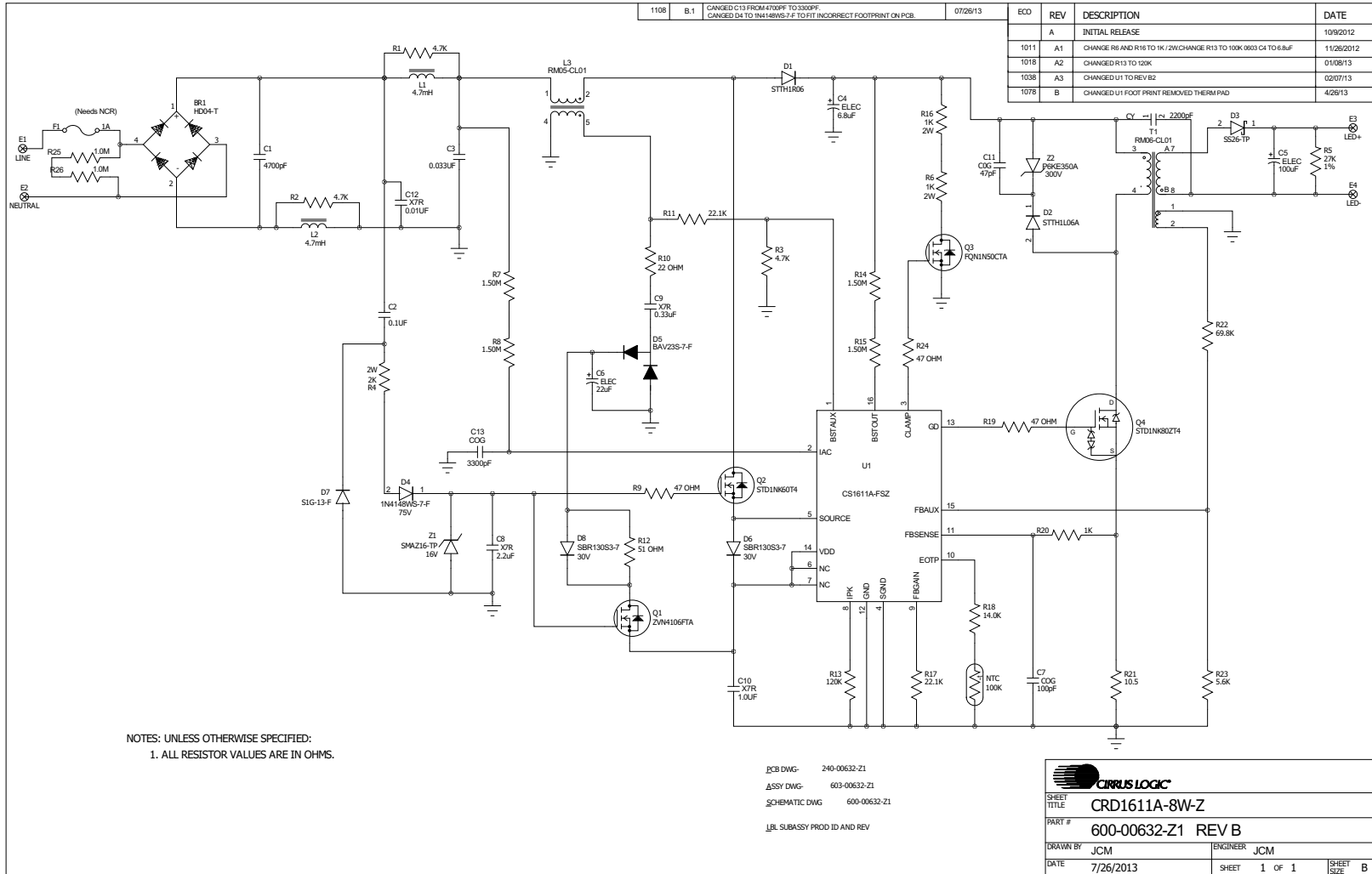

Figure 1. Schematic

3. BILL OF MATERIALS

Item	Rev	Description	Qty	Reference Designator	MFG	MFG P/N
1		DIODE RECT 400V 0.8A NPb MINIDIP	1	BR1	DIODES INC	HD04-T
2		CAP 4700PF ±10% 1000V X7R NPb 1206	1	C1	MURATA	GRM31BR73A472KW01L
3		CAP 0.1UF ±5% 400V MTL FLM RAD	1	C2	Panasonic	ECQE4104JF
4		CAP 0.033UF ±10% 400V MTL FLM RDL	1	C3	PANASONIC	ECQE4333KF
5		CAP 6.8uF ±20% 450V ELEC NPb RAD	1	C4	UNITED CHEMI-CON	EKXG451ELL6R8MJ20S
6		CAP 100uF ±20% 25V EL LO ESR NPb RD	1	C5	PANASONIC	EEUFM1E101
7		CAP 22UF ±20% 35V ELEC RAD	1	C6	PANASONIC	EEA-GA1V220H
8		CAP 100pF ±5% 50V COG NPb 0603	1	C7	KEMET	C0603C101J5GAC
9		CAP 2.2uF ±10% 10V X7R NPb 0805	1	C8	MURATA	GRM21BR71E225KA73L
10		CAP 0.33UF ±10% 50V X7R NPb 0603	1	C9	TDK	C1608X7R1H334K
11		CAP 1.0uF 10% 25V X7R NPb 0603	1	C10	MURATA	GRM188R71E105KA12D
12		CAP 47pF ±5% 1000V COG NPb 1206	1	C11	JOHANSON DIELECTRICS	102R18N470JV4E
13		CAP 0.01uF ±10% 630V X7R NPb 1206	1	C12	MURATA	GRM31BR72J103KW01L
14	A	CAP 3300pF ±5% 50V COG NPb 1206	1	C13	KEMET	C1206C332J5GAC
15		CAP 2200PF +80/-20% 2KV CER NPb RAD	1	CY	MURATA	DEBE33D222ZA2B
16		DIODE FAST 600V 1A NPb DO-41	1	D1	ST	STTH1R06
17		DIODE ULT FAST 600V 1A NPb SMA	1	D2	ST MICROELECTRONICS	STTH1L06A
18		DIODE SKY RECT 60V 2A NPb DO-214AC	1	D3	MICRO COMMERCIAL(MCC)	SS26-TP
19		DIODE SWT 75V 300mA NPb SOD323	1	D4	DIODES INC	1N4148WS-7-F
20		DIODE SWT 250V 0.4A NPb SOT-23	1	D5	DIODES INC	BAV23S-7-F
21		DIODE RECT 30V 1A NPb SOD-323	2	D6 D8	DIODES INC	SBR130S3-7
22		DIODE RECT 400V 1A NPb SMA	1	D7	DIODES INC	S1G-13-F
23		FUSE 1A 250V TLAG NPb RAD	1	F1	LITTLE FUSE	39211000440
24		IND 4.7mH ±10% 17.6 OHM 350 DIA TH	2	L1 L2	COILCRAFT	RFB0807-472L
25		XFMR 6.8mH ±10% 10 KHZ TH	1	L3	KUNSHAN EAGERNESS	RM05-CL01
26		THERM 100K OHM ±5% 0.10mA NPb 0603	1	NTC	MURATA	NCP18WF104J03RB
27		TRAN MOSFET nCH 60V.2A NPb SOT23-3	1	Q1	DIODES INC	ZVN4106FTA
28		TRAN MOSFET nCH 1.0A 600V NPb DPAK	1	Q2	ST MICROELECTRONICS	STD1NK60T4
29		TRAN MOSFET nCH 0.38A 500V NPb TO-92	1	Q3	FAIRCHILD	FQN1N50CTA
30		TRAN MOSFET nCH 1A 800V NPb DPAK	1	Q4	ST MICROELECTRONICS	STD1NK80ZT4
31		RES 4.7k OHM 1/4W ±5% NPb 1206 FILM	2	R1 R2	DALE	CRCW12064K70JNEA
32		RES 4.70K OHM 1/10W ±1% NPb 0603	1	R3	PANASONIC	ERJ3EKF4701V
33		RES PWR 2.0K OHM 2W ±5% NPb AXL	1	R4	VISHAY	PRO2000202001JR500
34		RES 27K OHM 1/8W ±1% NPb 0805	1	R5	PANASONIC	ERJ6ENF2702V
35		RES 1k OHM 2W ±5% MTL FLM NPb AXL	2	R6 R16	VISHAY	PRO2000201001JR500
36		RES 1.50M OHM 1/4W ±1% NPb 1206	4	R7 R8 R14 R15	PANASONIC	ERJ8ENF1504V
37		RES 47 OHM 1/10W ±1% NPb 0603	3	R9 R19 R24	PANASONIC	ERJ3EKF47ROV
38		RES 22.0 OHM 1/10W ±1% NPb 0603	1	R10	PANASONIC	ERJ3EKF22ROV
39		RES 22.1k OHM 1/10W ±1% NPb 0603	2	R11 R17	DALE	CRCW060322K1FKEA
40		RES 51.0 OHM 1/10W ±1% NPb 0603	1	R12	PANASONIC	ERJ3EKF51ROV
41		RES 120K OHM 1/10W ±1% NPb 0603	1	R13	PANASONIC	ERJ3EKF1203V
42		RES 14k OHM 1/10W ±1% NPb 0603 FILM	1	R18	DALE	CRCW060314K0FKEA
43		RES 1k OHM 1/10W ±1% NPb 0603 FILM	1	R20	DALE	CRCW06031K00FKEA
44		RES 10.5 OHM 1/4W ±1% NPb 1206	1	R21	DALE	CRCW120610R5FKEA
45		RES 69.8k OHM 1/10W ±1% NPb 0603	1	R22	DALE	CRCW060369K8FKEA
46		RES 5.6k OHM 1/10W ±5% NPb 0603 FILM	1	R23	DALE	CRCW06035K60JNEA
47		RES 1M OHM 1/8W ±1% NPb 0805	2	R25 R26	DALE	CRCW08051M00FKEA
48		XFMR 14.5mH ±10% 10 KHZ TH	1	T1	KUNSHAN EAGERNESS	RM06-CL01
49	B2	IC CRUS DIM 230V LED DRV NPb SOIC16	1	U1	CIRRUS LOGIC	CS1611A-FSZ/B2
50		DIODE ZENER 16V 1W NPb DO-214AC	1	Z1	MICRO COMMERCIAL	SMAZ16-TP
51		DIODE TVS 300V 600W NPb DO-204AC	1	Z2	LITTELFUSE	P6KE350A

Figure 2. Bill of Materials

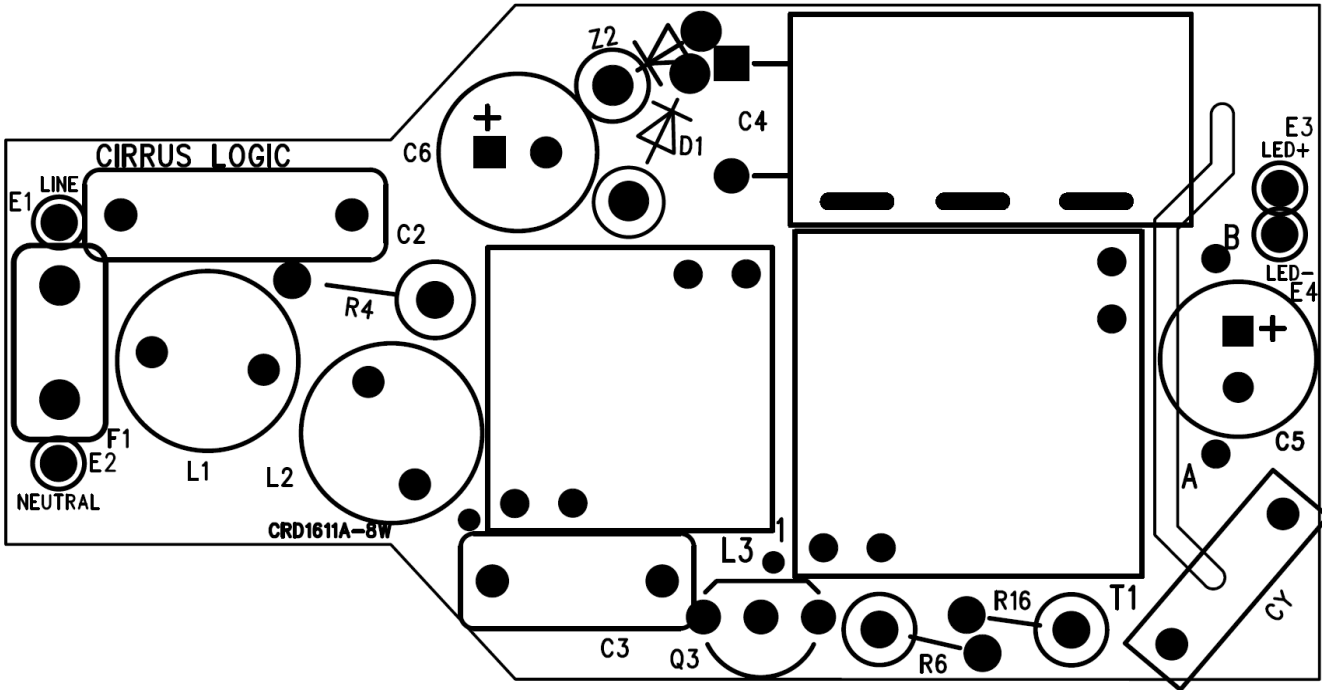

Figure 4. Top Silkscreen

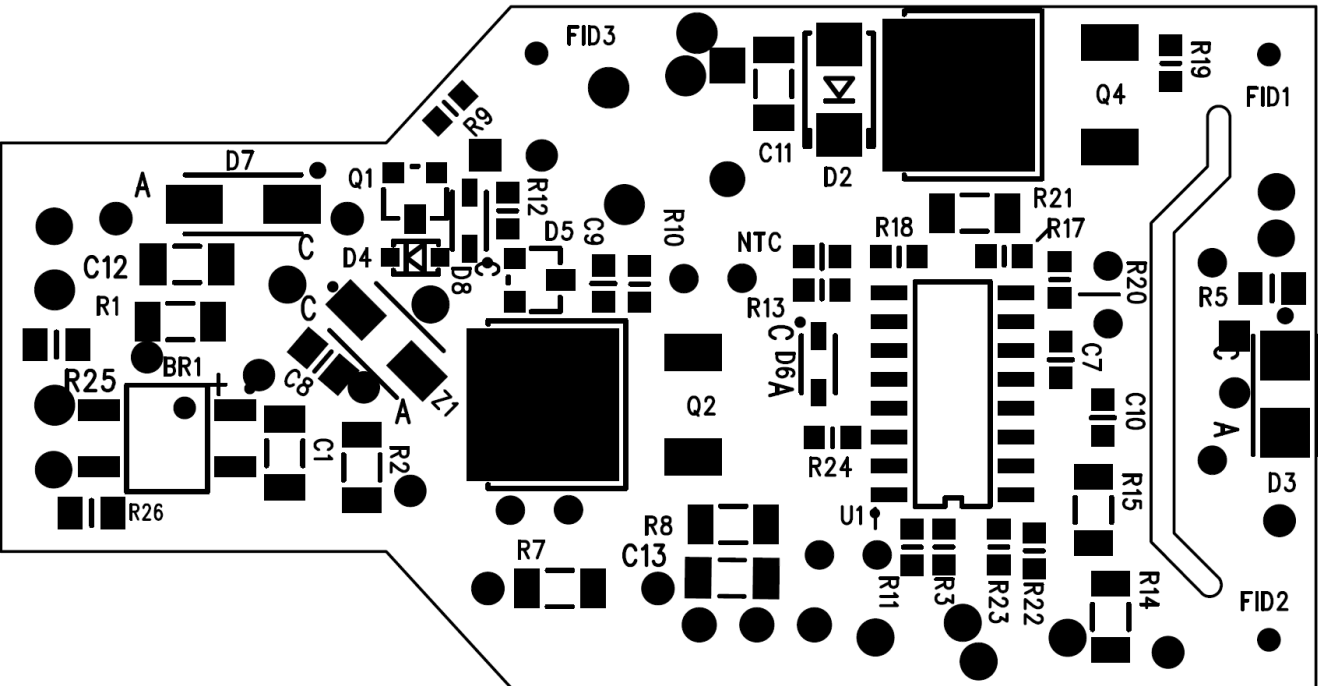

Figure 5. Bottom Silkscreen

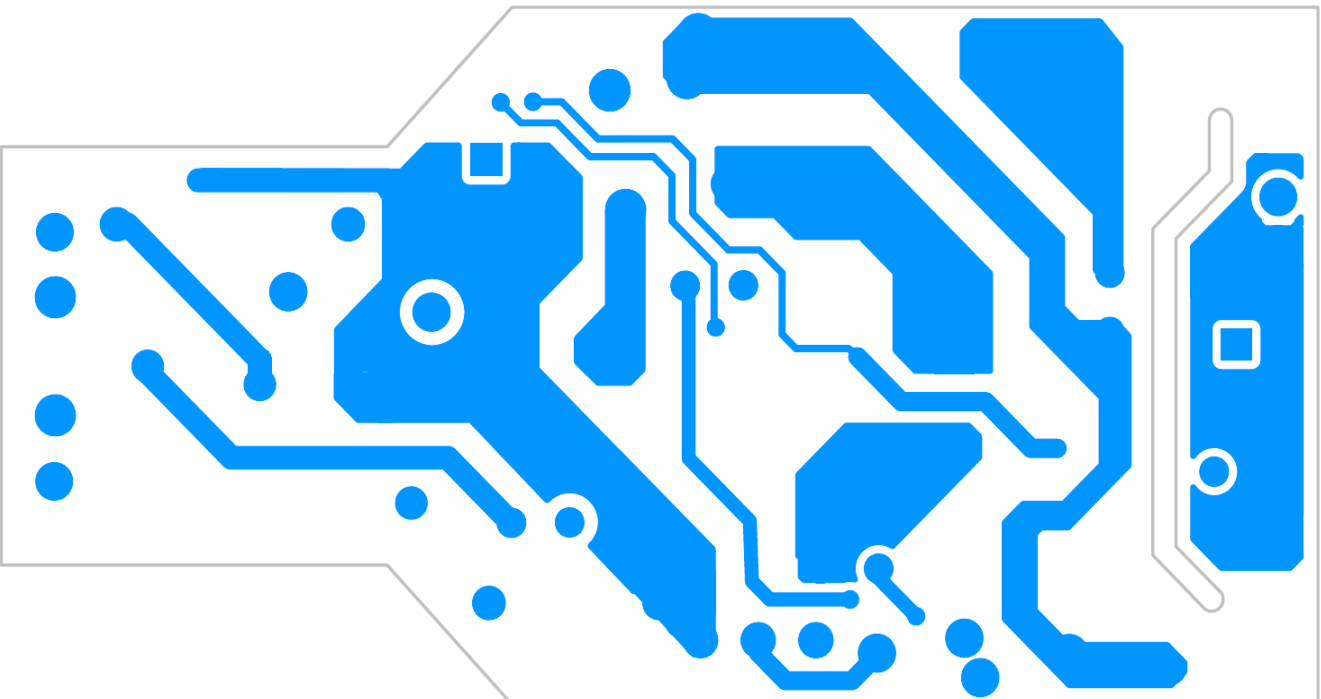

Figure 6. Top Routing

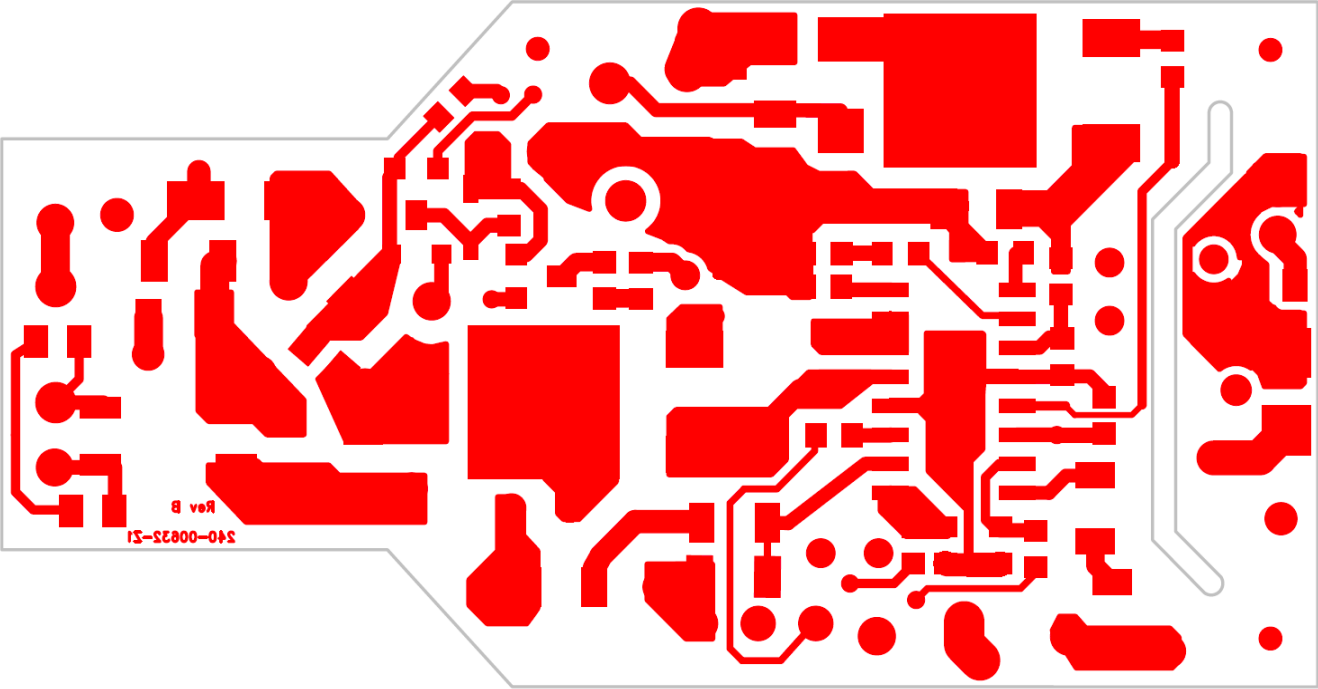

Figure 7. Bottom Routing

5. THERMAL IMAGING

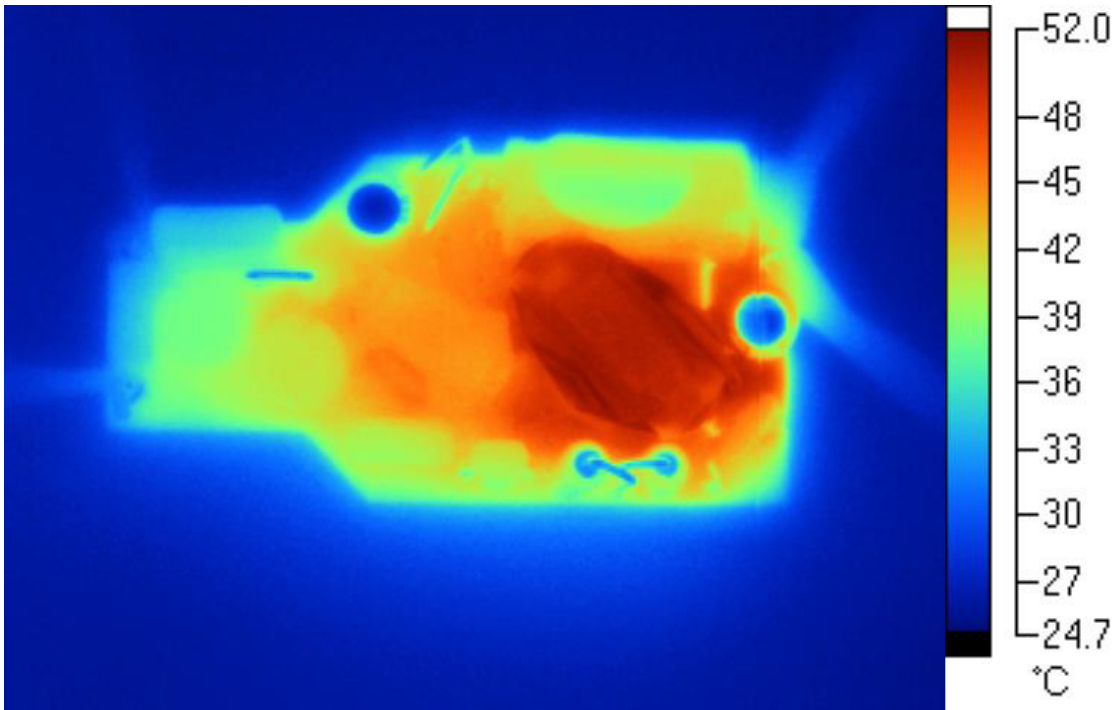

Figure 8. Top Thermal

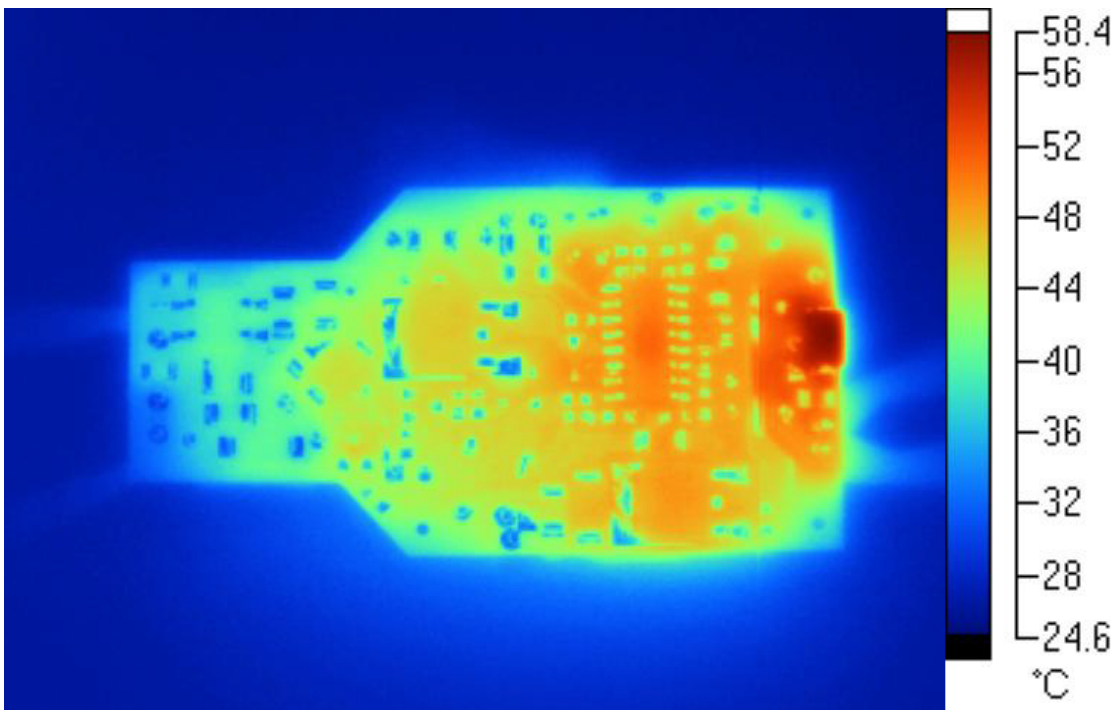

Figure 9. Bottom Thermal

6. DIMMER COMPATIBILITY

PAR 16 Lamp with a CS1611A (230V/50Hz)

Date	9/5/2013	Power Factor^{1,5}	0.907
Vendor	Cirrus Logic	IEC-61000-3-2 Compliant (Y/N)^{2,5}	Y
Input Voltage	230V/50Hz	EN55015 Compliant (Y/N)	Y
Form Factor	PAR 16	Nominal Input Power (W)^{1,5}	7.55
Model #	CRD1611A-8W	Maximum Input Power (W)^{1,5}	8.8
IC	CS1611A	Output Voltage (V)^{1,3}	11.43
Topology	Boost/Flyback	Output Current (mA)^{1,3}	542
Isolation (Y/N)	Y	Output Current Ripple \leq 120Hz (mA)^{1,4}	0
Efficiency (%)	82.1	Output Power (W)^{1,5}	6.195

Dimmer ⁶		Flicker Free Steady-State			Monotonic Dimming			Max I _{out} (%)			Min I _{out} (%)		
Manufacture	Type	# of lamps			# of lamps			# of lamps			# of lamps		
		1	5	10	1	5	10	1	5	10	1	5	10
Berker 286110	Universal	Y	Y	Y	Y	Y	Y	100.0	100.0	100.0	2.0	2.0	2.0
Bull 500W	Leading Edge	Y	Y	Y	Y	Y	Y	100.0	100.0	100.0	1.8	1.8	1.8
Busch 2247U	Leading Edge	Y	Y	Y	Y	Y	Y	100.0	100.0	100.0	1.8	1.8	1.8
Busch 6513U-102	Trailing Edge	Y	Y	Y	Y	Y	Y	99.8	99.8	99.8	1.8	1.8	1.8
Busch 6519U	Trailing Edge	Y	Y	Y	Y	Y	Y	100.0	100.0	100.0	1.8	1.8	1.8
Busch 6591U-101	Universal	Y	Y	Y	Y	Y	Y	100.0	98.3	96.3	1.8	1.8	1.8
Chint New7-6305	Leading Edge	Y	Y	Y	Y	Y	Y	100.0	99.8	100.0	1.8	2.0	1.8
Chisen	Trailing Edge	Y	N	N	Y	Y	Y	100.0	100.0	100.0	1.8	1.8	1.8
Chisen 350W	Leading Edge	Y	N	Y	Y	N	N	100.0	100.0	100.0	1.8	2.0	1.8
Clipsal 32E450UDM	Leading Edge	Y	Y	Y	Y	Y	Y	100.0	99.8	99.8	1.8	1.8	1.8
Clipsal EV51RD400	Leading Edge	Y	Y	Y	Y	Y	Y	100.0	100.0	100.0	1.8	1.8	1.8
CLSEN QSY626W	Leading Edge	Y	N	N	Y	Y	Y	100.0	100.0	100.0	2.0	3.1	3.5
Cshyh 150W	Leading Edge	Y	Y	N	Y	Y	Y	100.0	100.0	100.0	2.6	4.1	4.2
Dbang	Leading Edge	Y	Y	N	Y	N	Y	100.0	100.0	100.0	2.0	2.8	2.0
Futina 250W	Leading Edge	Y	Y	Y	Y	Y	Y	100.0	100.0	100.0	3.7	3.7	3.7
Gira 118400	Leading Edge	Y	Y	Y	Y	Y	Y	100.0	100.0	100.0	2.0	2.0	2.0
HPM 1000L	Leading Edge	Y	Y	Y	Y	Y	Y	74.0	74.5	74.2	1.8	1.8	1.8
HPM 250L	Leading Edge	Y	Y	Y	Y	Y	Y	73.4	74.0	74.2	1.8	1.8	1.8
HPM 250LWE	Leading Edge	Y	Y	Y	Y	Y	Y	86.9	86.9	87.3	1.8	1.8	1.8
HPM 250T	Trailing Edge	Y	Y	Y	Y	Y	Y	100.0	100.0	100.0	1.8	1.8	1.8
HPM 400T	Trailing Edge	Y	Y	Y	Y	Y	Y	100.0	100.0	100.0	1.8	1.8	1.8

Dimmer ⁶		Flicker Free Steady-State			Monotonic Dimming			Max I _{out} (%)			Min I _{out} (%)		
Manufacture	Type	# of lamps			# of lamps			# of lamps			# of lamps		
		1	5	10	1	5	10	1	5	10	1	5	10
HPM 700L	Leading Edge	Y	Y	Y	Y	Y	Y	86.2	85.2	85.2	1.8	1.8	1.8
HPM LN250T	Trailing Edge	Y	Y	Y	Y	Y	N	97.4	95.4	100.0	1.8	1.8	1.8
HPM LN400L	Leading Edge	Y	Y	Y	Y	Y	Y	76.9	76.8	86.7	1.8	1.8	1.8
HPM XL1000T	Trailing Edge	Y	Y	Y	Y	Y	Y	100.0	99.1	97.8	1.8	1.8	1.8
HPM XL250T	Trailing Edge	Y	Y	Y	Y	Y	Y	96.5	94.5	93.5	1.8	1.8	1.8
HPM XL700L	Leading Edge	Y	Y	Y	Y	Y	Y	83.0	83.0	82.5	1.8	1.8	1.8
KOPP 8078	Trailing Edge	Y	Y	N	Y	Y	N	100.0	100.0	-	1.8	1.8	-
Leiben 450W	Leading Edge	N	Y	Y	Y	Y	Y	100.0	100.0	100.0	1.8	1.8	1.8
Lonon NB50.0TG	Leading Edge	Y	Y	Y	Y	Y	Y	100.0	100.0	100.0	1.8	1.8	1.8
Lutron LLSI-502	Leading Edge	Y	Y	Y	Y	Y	Y	100.0	100.0	100.0	1.8	1.8	1.8
Lutron LLSM-502	Leading Edge	Y	Y	Y	Y	Y	Y	88.6	89.7	89.3	1.8	1.8	1.8
Merten 5725	Leading Edge	Y	Y	Y	Y	Y	Y	100.0	100.0	100.0	1.8	1.8	1.8
Merten 5771	Trailing Edge	Y	Y	Y	Y	Y	Y	87.5	83.0	81.0	1.8	1.8	1.8
MK 52471SL	Leading Edge	Y	Y	Y	Y	Y	Y	100.0	100.0	100.0	2.0	1.8	1.8
N&L 28985	Trailing Edge	Y	Y	N	Y	Y	N	95.0	92.1	-	1.8	1.8	-
Opus 852.390	Leading Edge	Y	Y	Y	Y	Y	Y	100.0	100.0	100.0	2.2	2.0	2.0
Opus 852.392	Leading Edge	Y	Y	Y	Y	Y	Y	100.0	100.0	100.0	3.1	3.1	3.1
Siemens 5GT0200	Leading Edge	Y	Y	Y	Y	Y	Y	100.0	100.0	100.0	1.8	1.8	1.8
T&J K211-1KM2	Leading Edge	Y	Y	Y	Y	Y	Y	100.0	100.0	100.0	2.0	1.8	1.8
T&J K211-M2	Leading Edge	Y	Y	Y	Y	Y	Y	100.0	100.0	100.0	1.8	1.8	1.8
TCL LM2	Leading Edge	Y	Y	Y	Y	Y	Y	100.0	100.0	100.0	1.8	1.8	1.8
TNC Z26-M12	Leading Edge	N	N	Y	Y	Y	Y	100.0	100.0	100.0	1.8	1.8	1.8
Wuyun W13-C162	Trailing Edge	Y	Y	N	Y	Y	N	100.0	100.0	-	1.8	1.8	-

- Notes:
1. Tested at nominal input voltage, nominal input frequency and without a dimmer after soaking for 15 minutes
 2. Compliant with IEC 61000-3-2 Class C < 25W
 3. Average
 4. Peak-to-peak
 5. Measured with Chroma 66202 Power Analyzer
 6. This document includes trademarks, trade names, brands, logos, product names and/or product identifiers of companies other than Cirrus Logic, Inc. All such trademarks, trade names, brands, logos, product names, and product identifiers are for identification purposes only and are the property of their respective owners, who are not affiliated with Cirrus Logic. Please visit the respective sites of those owners to obtain a listing or understanding of their trademark rights. This document also includes results from testing performed by Cirrus Logic for its own purposes and for which there are currently no industry standards. While this testing was applied objectively, its results may include at least some degree of subjectivity. The testing or test results should not be interpreted as any comment on the overall quality or suitability of any tested products.

7. INDUCTOR CONSTRUCTION

The CRD1611A-8W includes a critical conduction mode (CRM) boost converter that provides power factor correction and dimmer compatibility with a constant output current, quasi-resonant flyback stage. The following sections describe the boost and flyback inductors installed on the CRD1611A-8W.

7.1 Boost Inductor

The CS1611A uses an adaptive dimmer compatibility algorithm to control the boost inductor stage, which guarantees dimmer compatibility operation plus enables flicker-free operation with leading-edge, trailing-edge, and digital dimmers (dimmers with an integrated power supply). The boost auxiliary winding is used for zero-current detection (ZCD) and supplies power to the CS1611A.

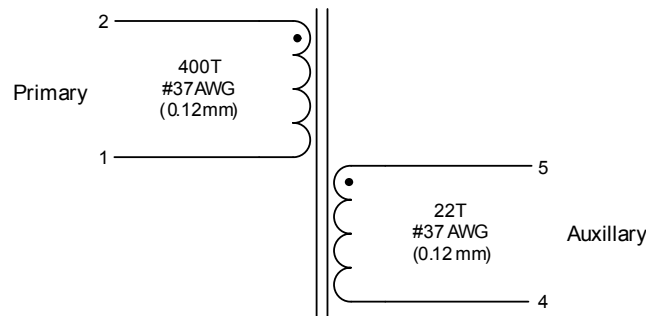

Figure 10. Boost Inductor Schematic

7.1.1 Electrical Specifications

Characteristics conditions:

- Operating temperature range: -25 °C to +120 °C (including coil heat)

Parameter	Condition	Symbol	Min	Typ	Max	Unit
Boost Inductor						
Primary Inductance (Note 1)	$f_{resonant} = 10\text{kHz}$, 0.3V at 20°C	L_p	6.12	6.8	7.48	mH
Primary DC Resistance (Note 1)	$t_{DCR} = 20^\circ\text{C}$		12	15	18	Ω
Auxiliary DC Resistance (Note 2)	$t_{DCR} = 20^\circ\text{C}$		0.84	1.05	1.26	Ω

- Notes:
1. Measured across pins 1 and 2
 2. Measured across pins 5 and 4

7.2 Flyback Transformer

The flyback transformer stage is a quasi-resonant peak current-regulated DC-DC converter capable of delivering the highest possible efficiency with constant current output while minimizing line frequency ripple. The auxiliary winding is used for zero-current detection and overvoltage protection.

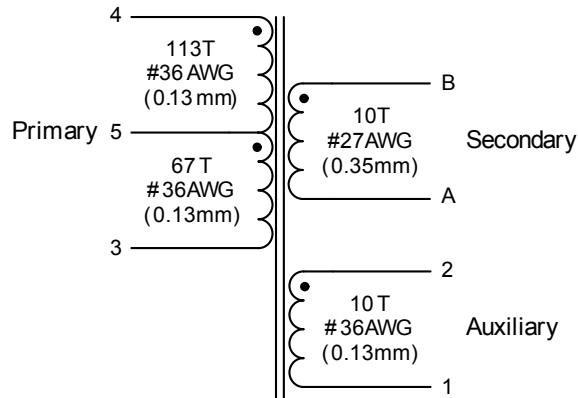

Figure 11. Flyback Transformer Schematic

7.2.1 Electrical Specifications

Characteristics conditions:

- Operating temperature range: -25 °C to +120 °C (including coil heat)

Parameter	Condition	Symbol	Min	Typ	Max	Unit
Flyback Transformer						
Electrical Strength	(Note 3) $f_{\text{operate}}=50/60\text{Hz}$		-	4	-	K
Primary Inductance	(Note 4) $f_{\text{resonant}}=10\text{kHz}, 0.3\text{V at }20^{\circ}\text{C}$	L_P	13.05	14.5	15.95	mH
Primary Leakage Inductance	(Note 4) $f_{\text{resonant}}=10\text{kHz}, 0.3\text{V at }20^{\circ}\text{C}$	L_K	-	106	-	μH
Primary DC Resistance	(Note 4) $t_{\text{DCR}}=20^{\circ}\text{C}$		5.25	7.0	8.75	Ω
Secondary DC Resistance	(Note 5) $t_{\text{DCR}}=20^{\circ}\text{C}$		-	120	-	m Ω
Auxiliary DC Resistance	(Note 6) $t_{\text{DCR}}=20^{\circ}\text{C}$		-	400	-	m Ω

- Notes:
3. Time = 2s
 4. Measured across pins 3 and 4
 5. Measured across pins B and A
 6. Measured across pins 2 and 1

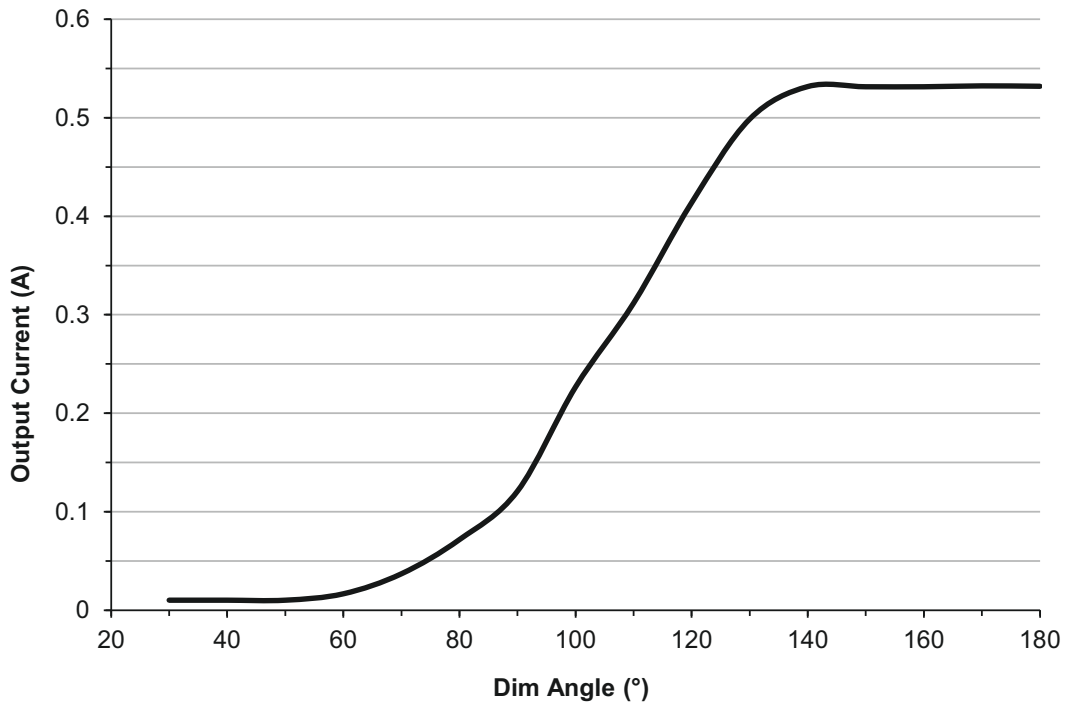
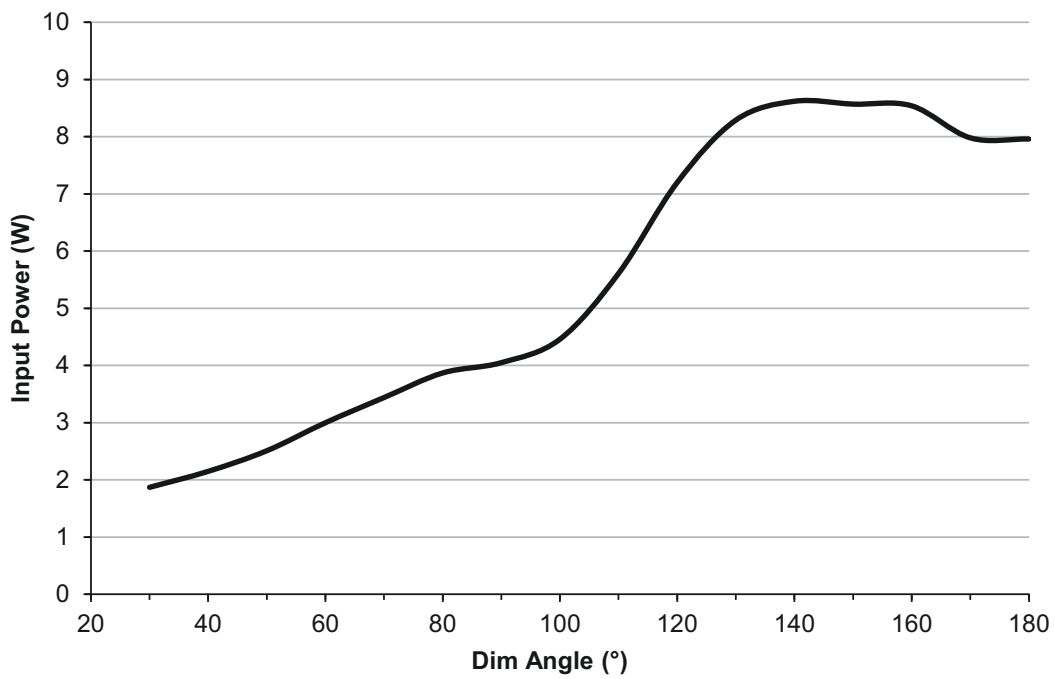
8. PERFORMANCE PLOTS

Figure 12. Typical Output Current vs. Dim Angle

Figure 13. Typical Input Power vs. Dim Angle

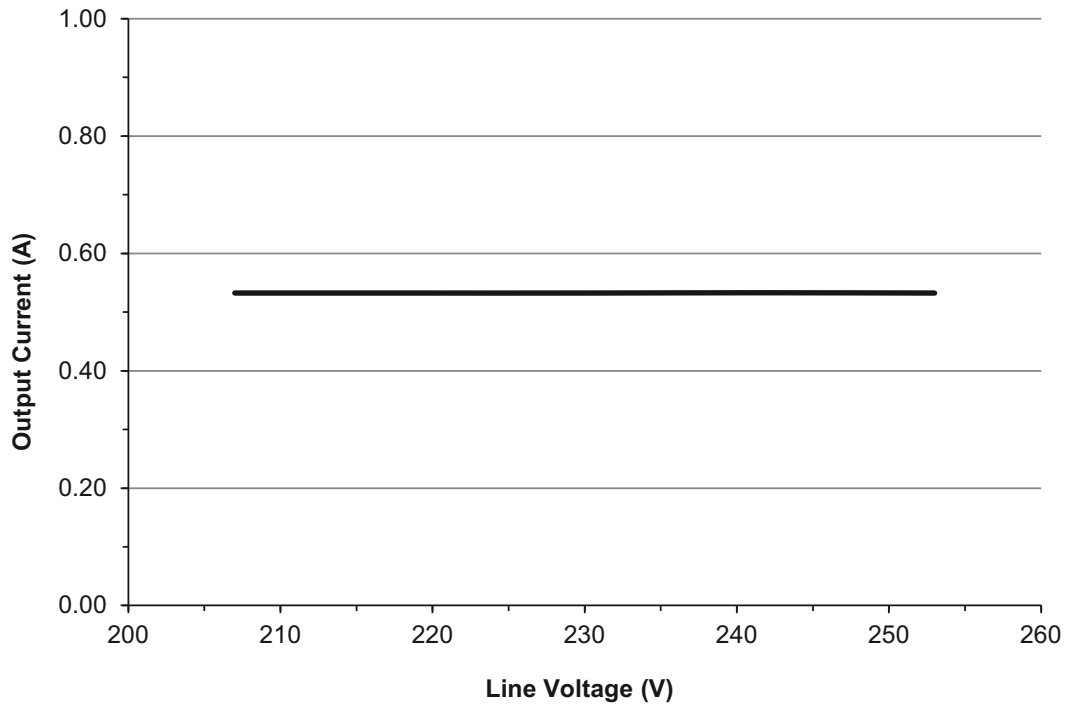

Figure 14. Output Current vs. Line Voltage, 207VAC to 253VAC

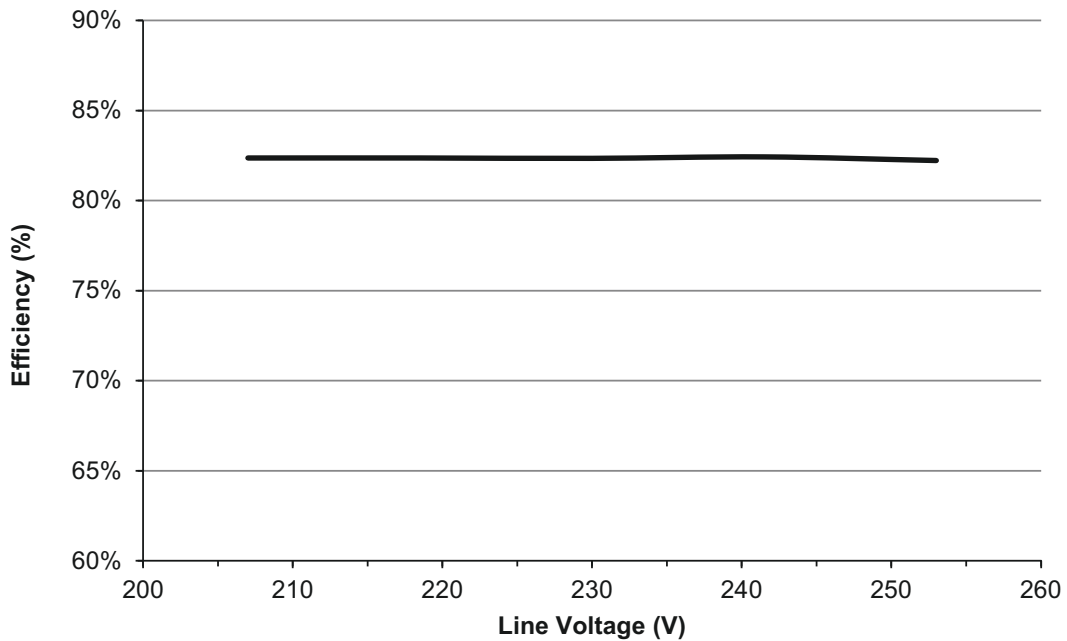

Figure 15. Typical Efficiency vs. Line Voltage, 207VAC to 253VAC

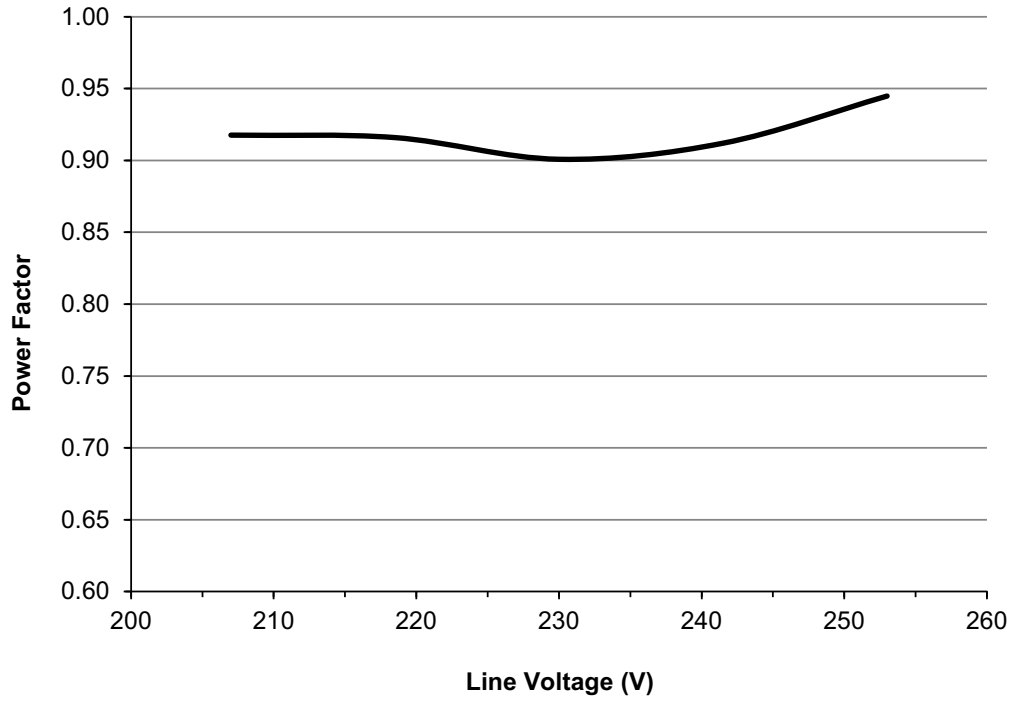

Figure 16. Power Factor vs. Line Voltage, 207VAC to 253VAC

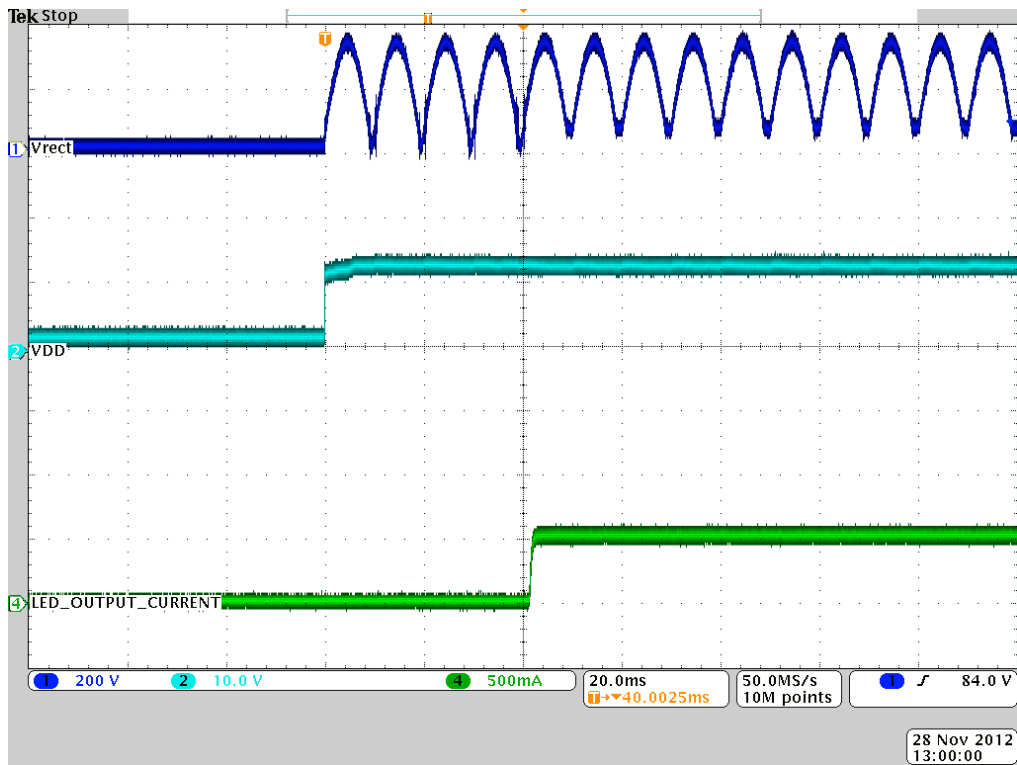

Figure 17. No-dimmer Mode, Startup, 230VAC

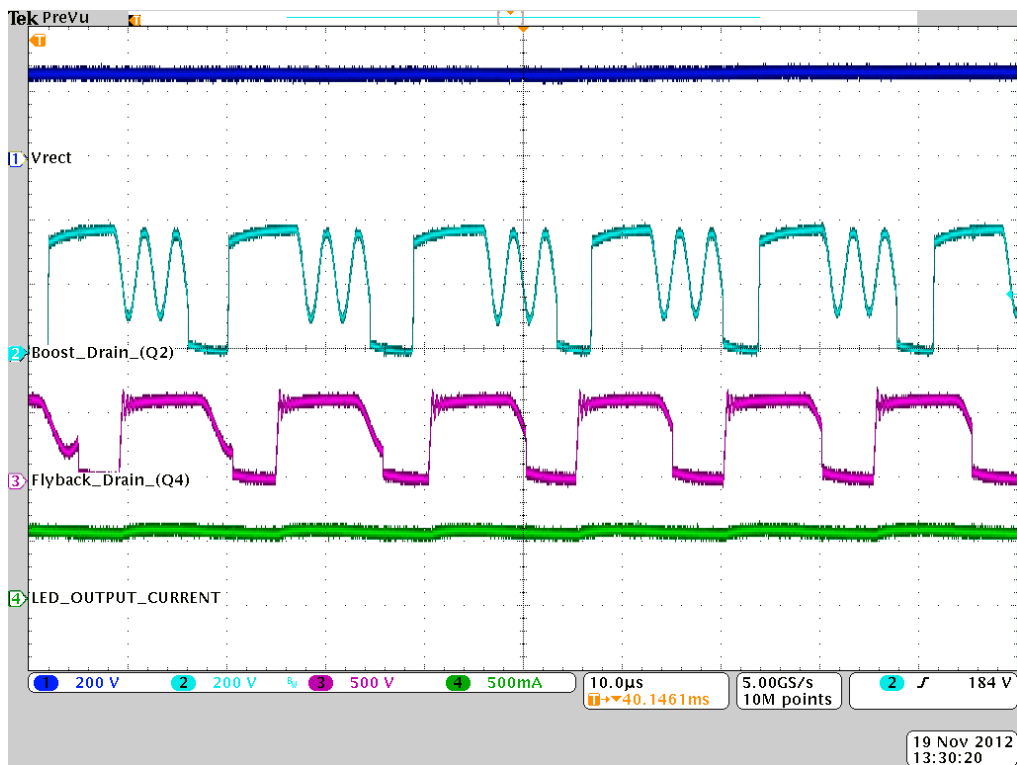

Figure 18. No-dimmer Mode, Steady-state, 230VAC

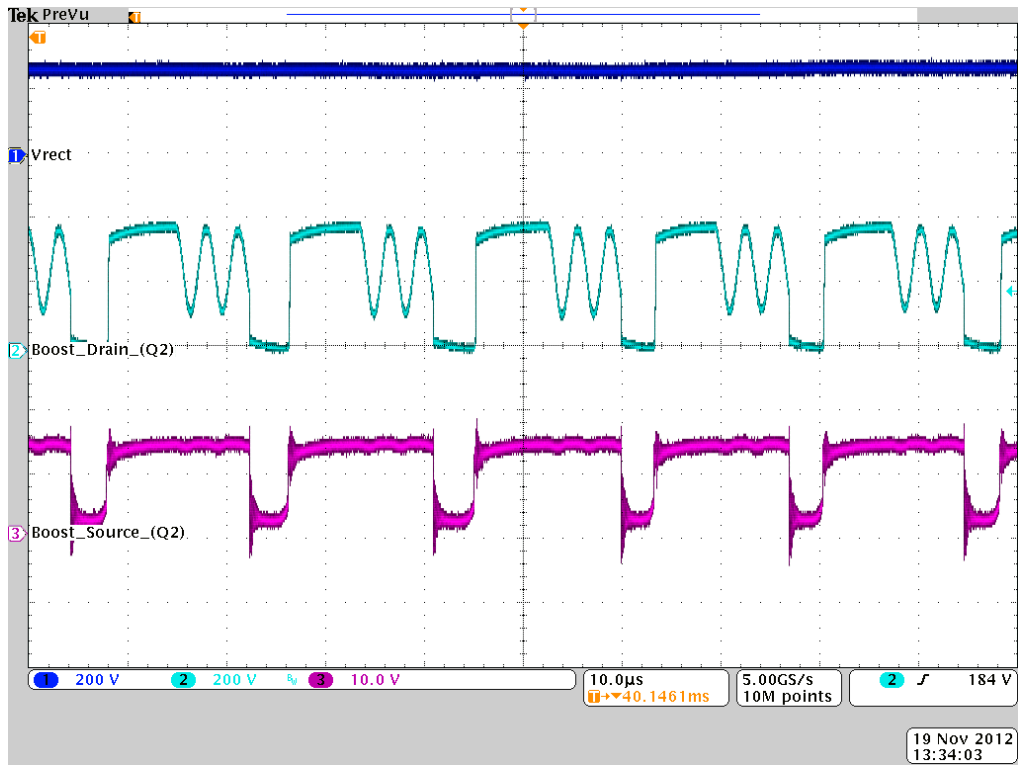

Figure 19. Boost FET Q2 Waveform

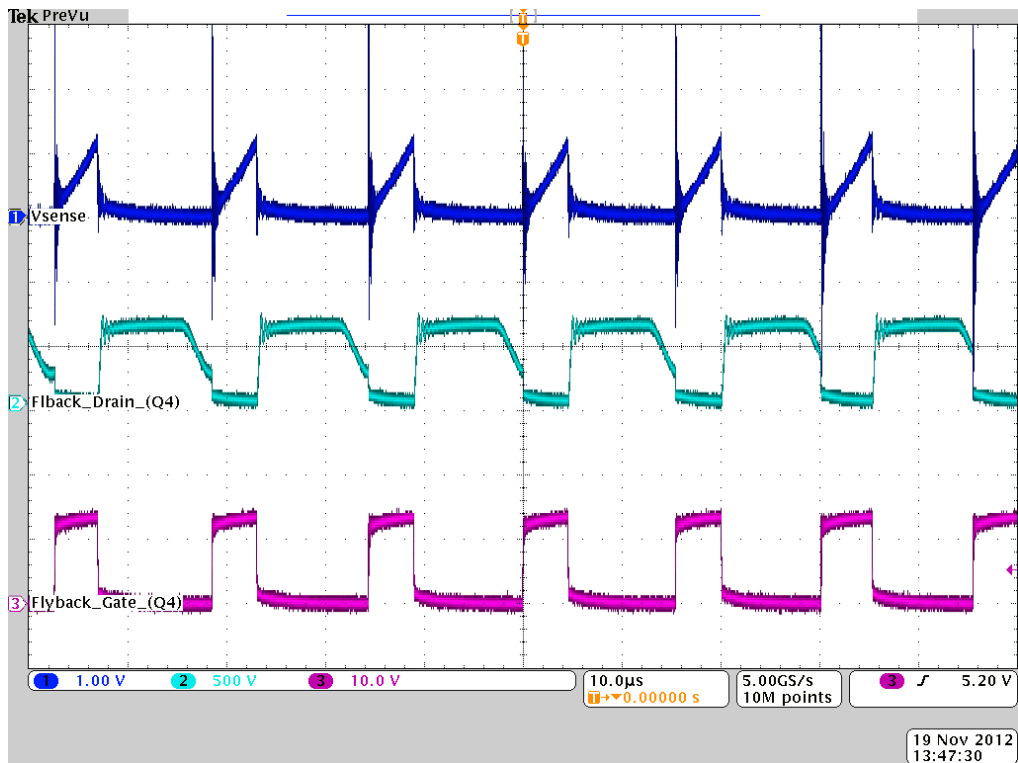

Figure 20. Flyback FET Q4 Waveform

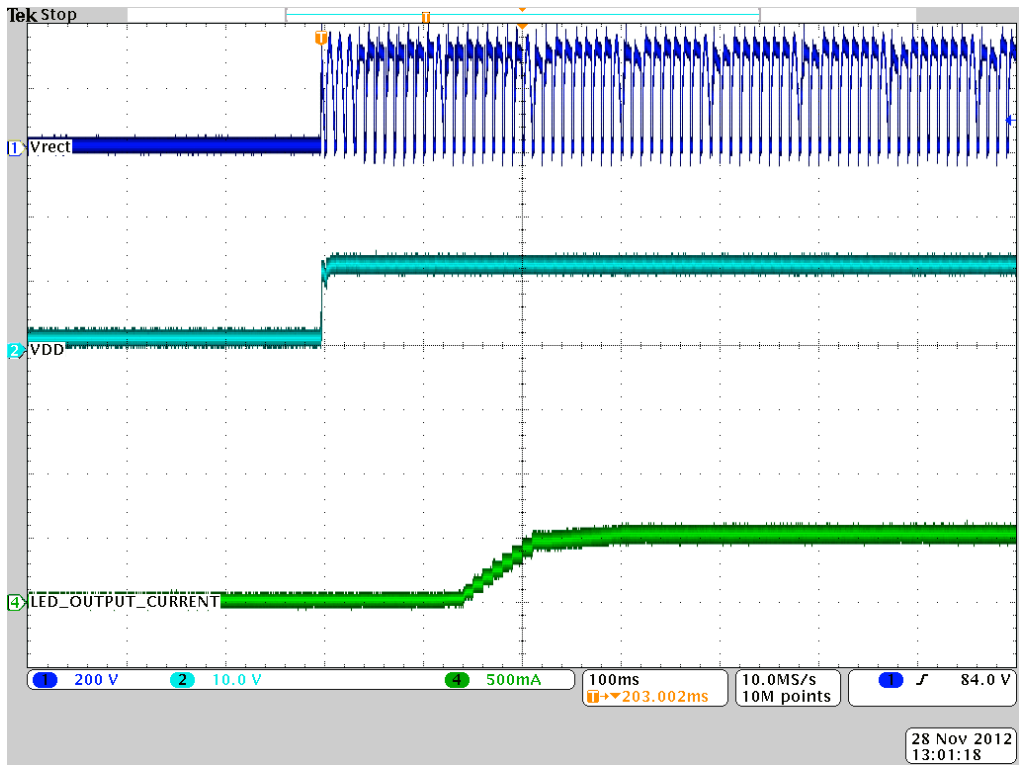

Figure 21. ILED at Maximum Dim Angle, Turn-on Waveforms

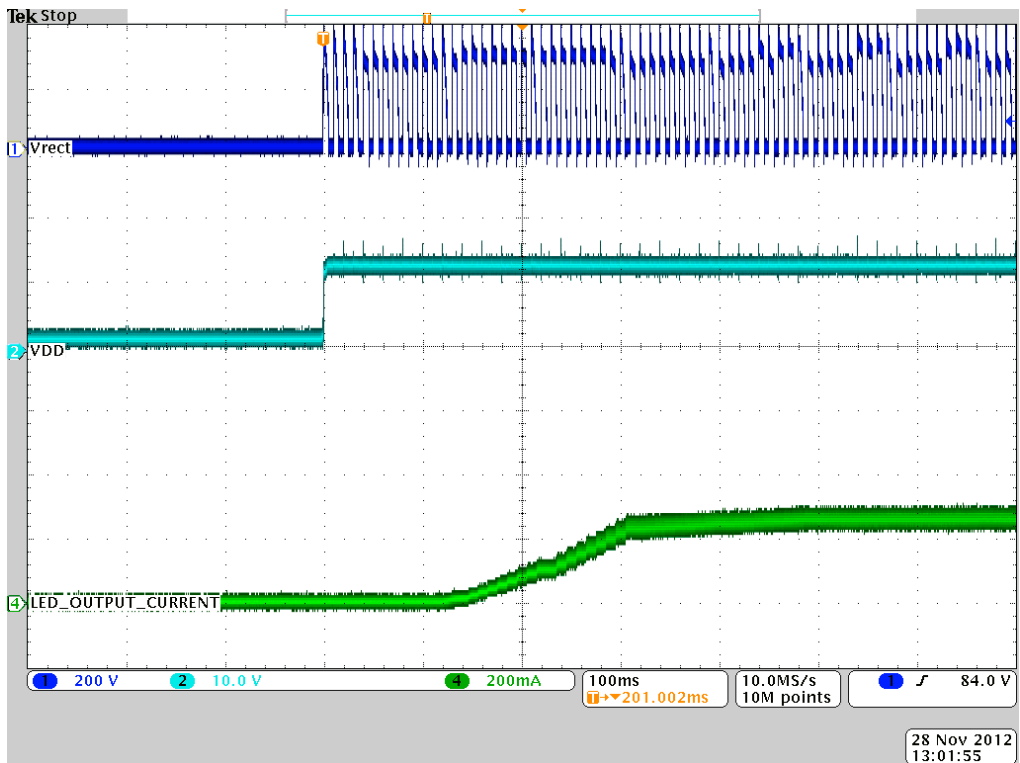

Figure 22. ILED at Medium Dim Angle, Turn-on Waveforms

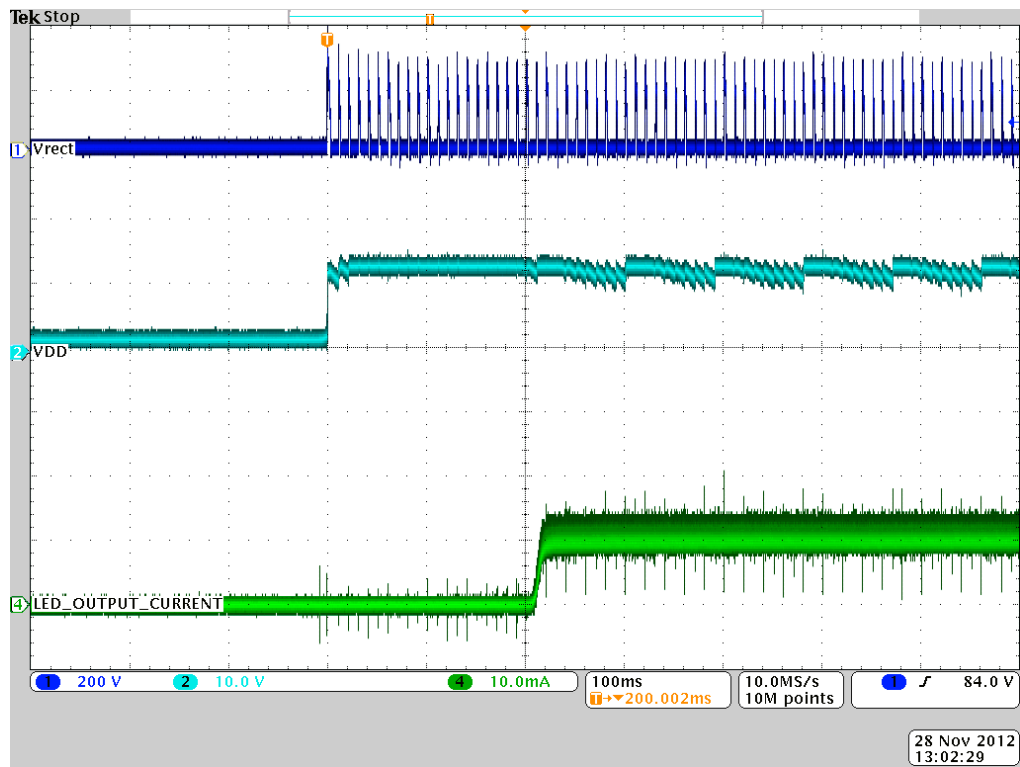

Figure 23. ILED at Minimum Dim Angle, Turn-on Waveforms

9. CONDUCTED EMI
Device Under Test: CRD1611A-8W-Z

Operating Conditions: NOMNIAL

Test Specification: IEC 61000-3-2

Operator Name: JDW & JCM

Scan Settings (1 Range)

Frequencies			Receiver Settings			
Start	Stop	Step	Res BW	M-Time	Atten	Preamp
150kHz	30MHz	4.5kHz	9kHz (6dB)	10ms	Auto	Off

Final Measurement
Detectors: QP, AV

Peaks: 25

Meas Time: 1s

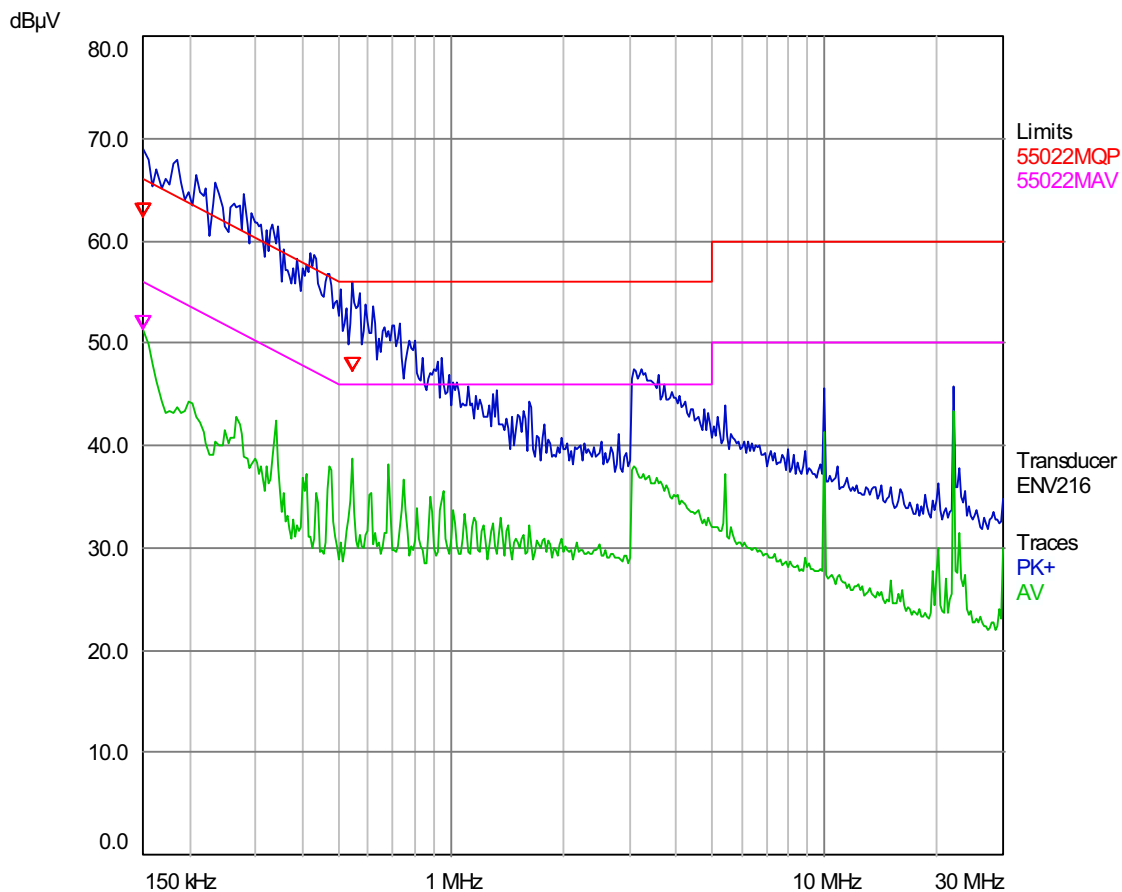
Acc. Margin: 6dB

Figure 24. Conducted EMI
Final Measurement Results

Trace	Frequency (MHz)	Level (dBµV)	Limit (dBµV)	Delta Limit (dB)	Delta Ref (dB)	Comment
1QP	0.15	62.42	66.00	-3.58		N/on
2AV	0.15	51.27	56.00	-4.73		N/on
1QP	0.546	47.18	56.00	-8.82		N/on

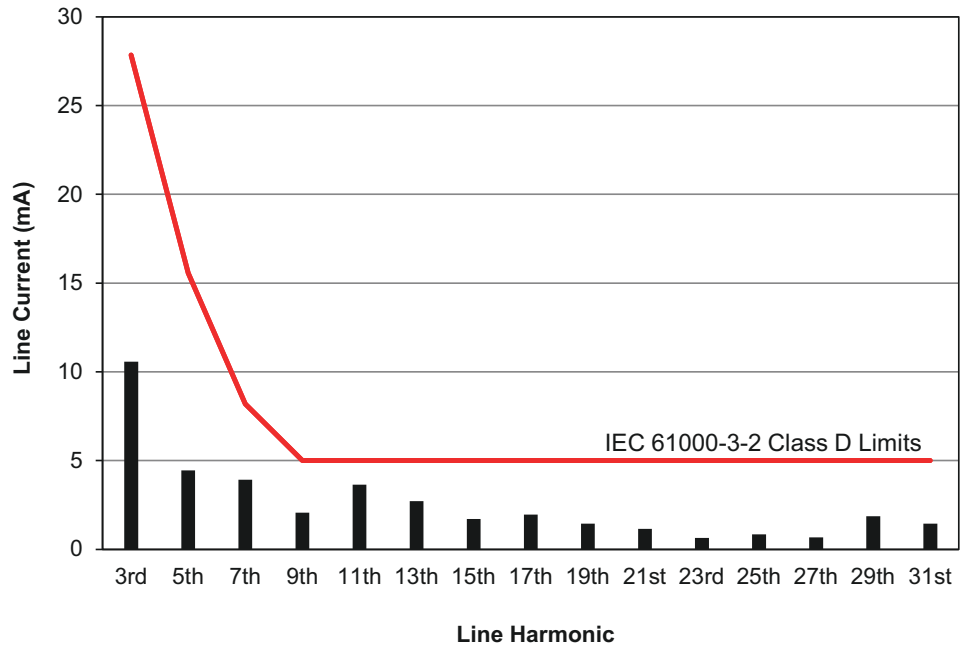
* = Limit Exceeded

10. HARMONIC CONTENT

Figure 25. Harmonic Content

11. REVISION HISTORY

Revision	Date	Changes
RD1	FEB 2013	Initial release
RD2	MAR 2013	Context clarification
RD3	SEP 2013	PCBA revision B content clarification