

□

TLC5947 and TLC59711 PWM LED Driver Breakouts

Created by Bill Earl

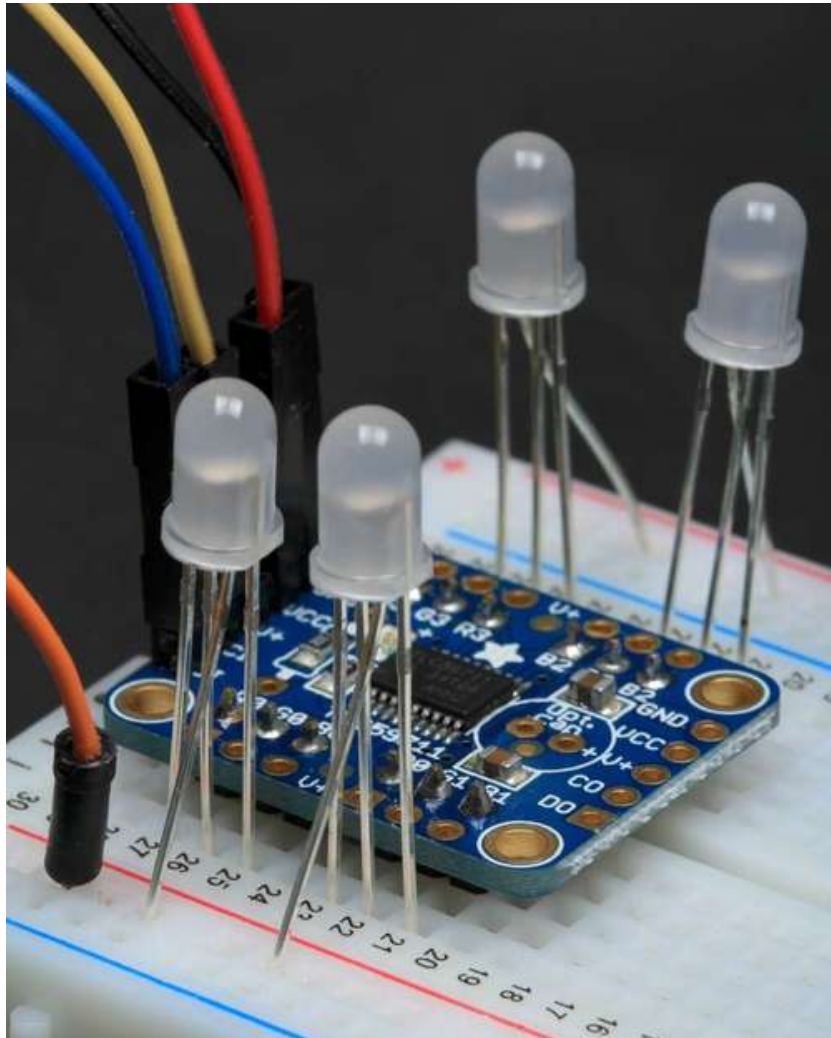

Last updated on 2016-12-29 12:11:52 AM UTC

Guide Contents

| | |
|---------------------------------|----|
| Guide Contents | 2 |
| Overview | 3 |
| Assembly | 6 |
| Assembly: | 6 |
| Soldering the Headers | 6 |
| Position the header | 7 |
| Position the board | 7 |
| And solder! | 8 |
| Repeat for the other side | 8 |
| Connecting to the Arduino | 9 |
| 24-Channel TLC5947 | 9 |
| 12-Channel TLC59711 | 10 |
| Chaining Boards | 12 |
| Power and LEDs | 14 |
| Connecting Monochrome LEDs | 14 |
| Off-Board Mounting | 15 |
| Connecting RGB LEDs | 16 |
| Multiple LEDs in Series | 17 |
| Powering your LEDs | 17 |
| Constant Current | 17 |
| Choosing a Supply Voltage | 18 |
| Connecting an External Supply | 18 |
| Programming - Library Reference | 19 |
| Install The Library | 19 |
| Run the Example Code | 19 |
| TLC5947 Library Reference: | 19 |
| TLC59711 Library Reference: | 20 |
| Downloads and Links | 22 |
| Libraries: | 22 |
| Data Sheets & Files | 22 |
| TLC5947 Schematic & Print | 22 |
| TLC59711 Schematic and Print | 24 |

Overview

The TLC59711 and TLC5947 breakout boards are ideal for applications requiring precise control of lots of LEDs.

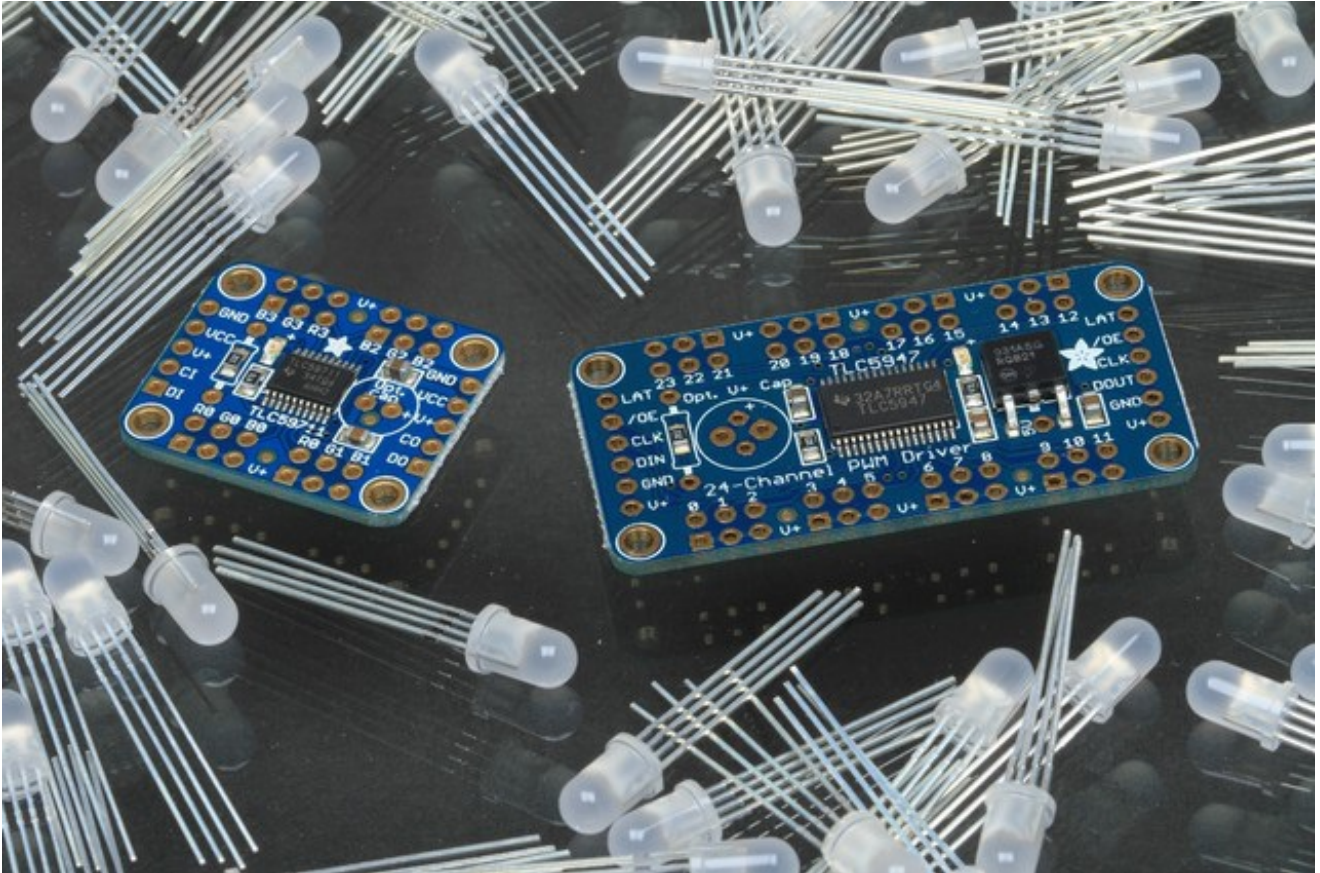

The **TLC59711** can control 12 separate channels of 16-bit PWM output. This is the highest-resolution PWM board we've seen!

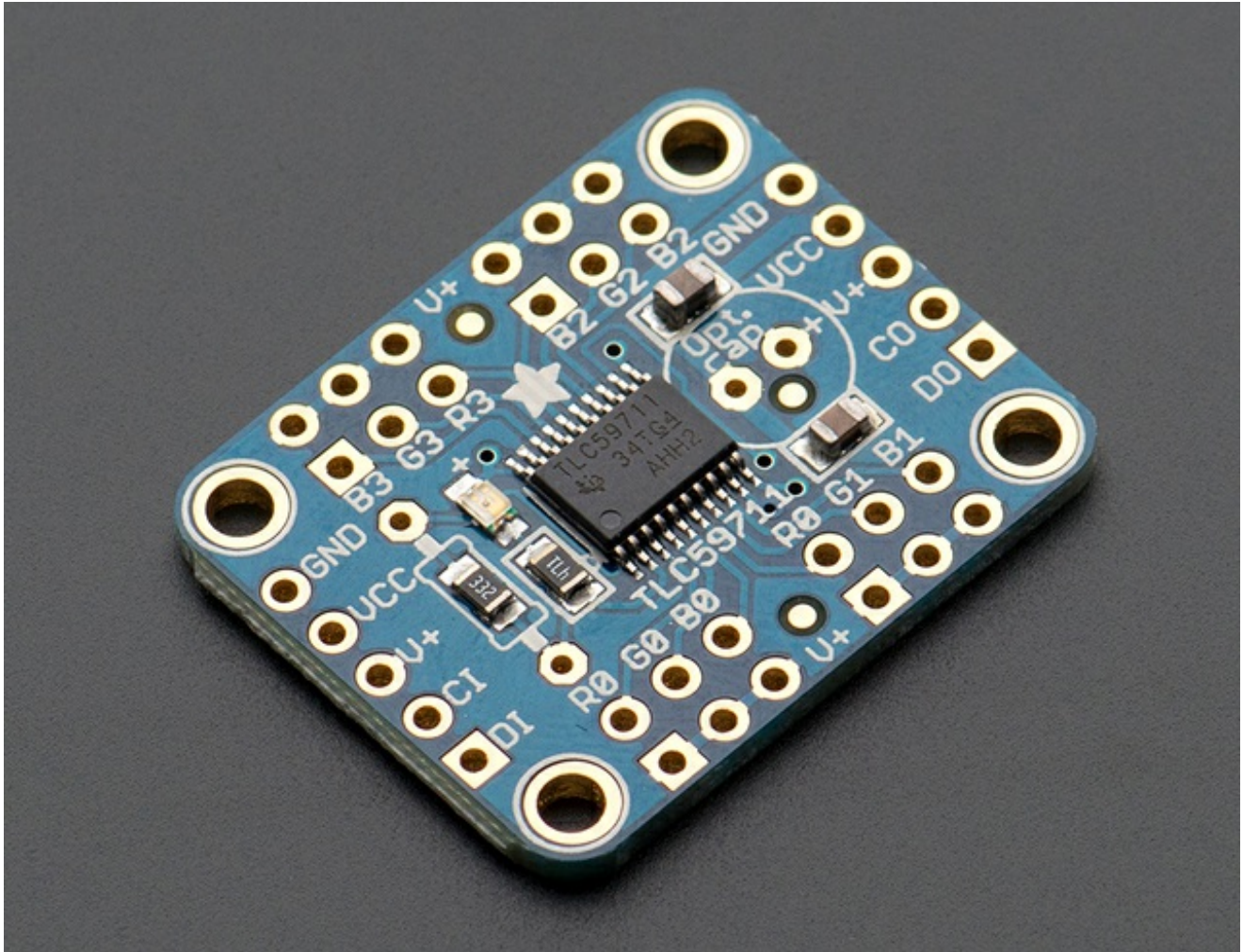

The **TLC5947** has even more channels. It can control 24 separate channels with 12-bit PWM output.

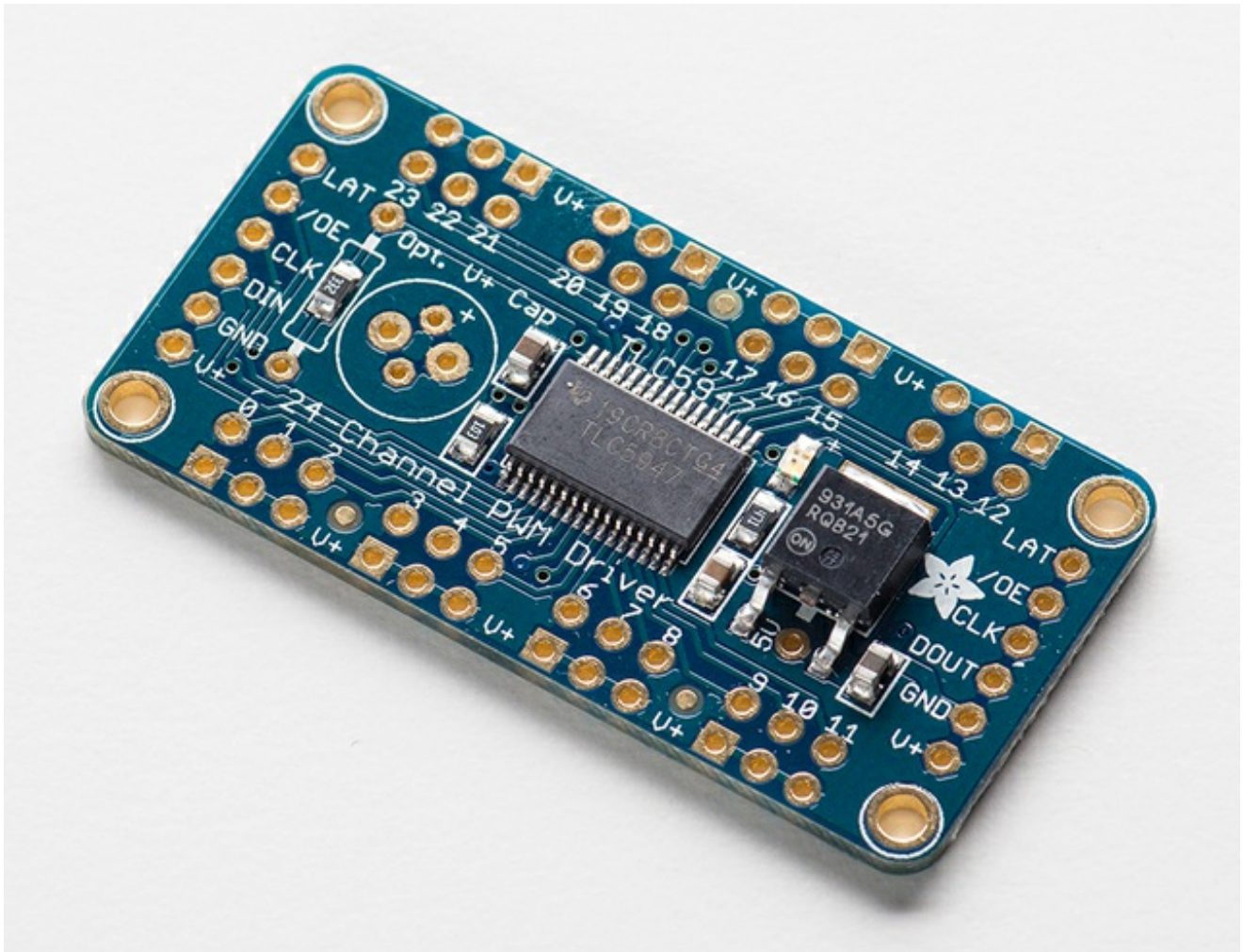

Both boards have a 2 or 3-pin SPI interface. Our library lets you use any two (TLC59711) or three (TLC5947) free pins to drive them. Best of all, you can chain multiple boards together to control hundreds or thousands of LEDs!

Outputs from these boards are constant-current and open drain. You can drive multiple LEDs in series. One resistor is used to set the current for each of the outputs, the constant current means that the LED brightness doesn't vary if the power supply dips.

We supply these with a 3.3K resistor for about 15mA per channel. But you can solder a thru-hole resistor over it if you'd like to change that value

Assembly

Assembly:

These boards come fully assembled and tested. We include optional header strips in case you want to use these on a breadboard. These take just a few minutes to install. For use in a breadboard, it is easiest to have the control connections on top of the board and the led connections on the bottom as shown below:

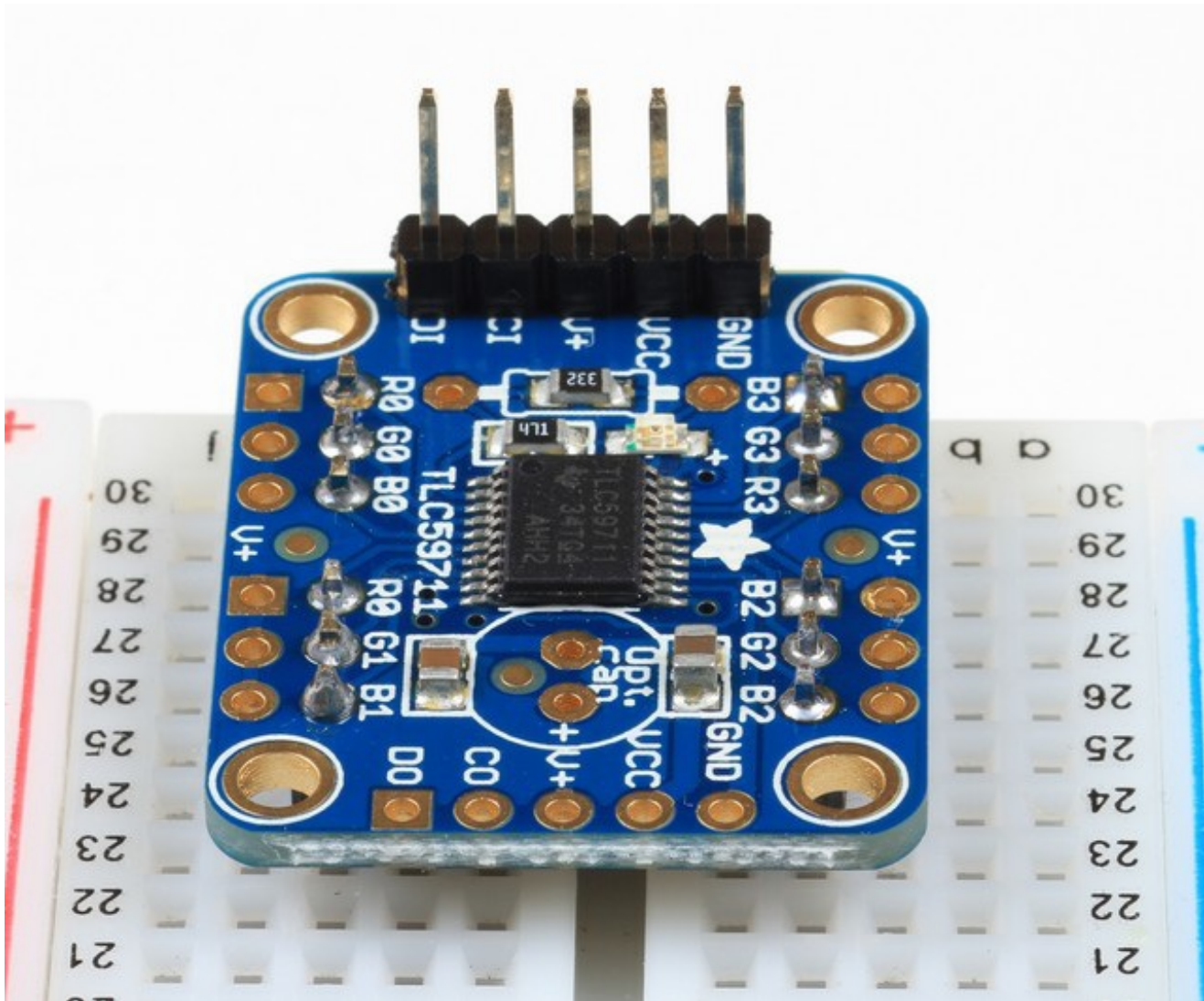

Soldering the Headers

Use the breadboard to hold the parts in position for soldering.

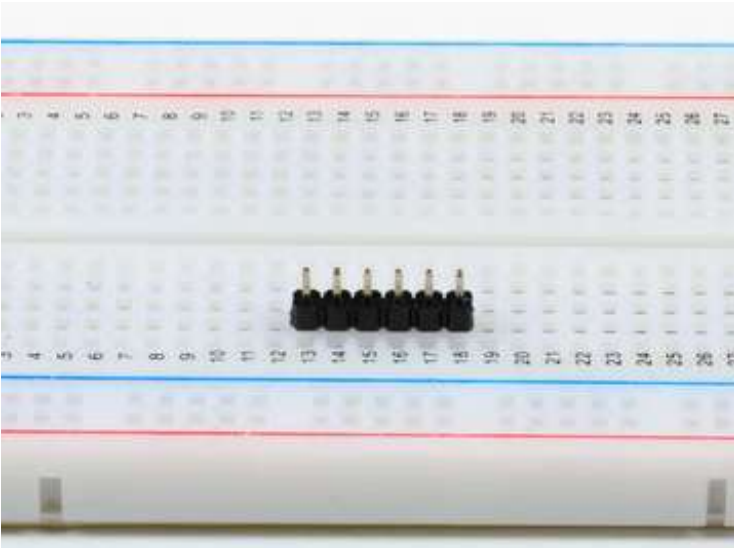

•

Position the header

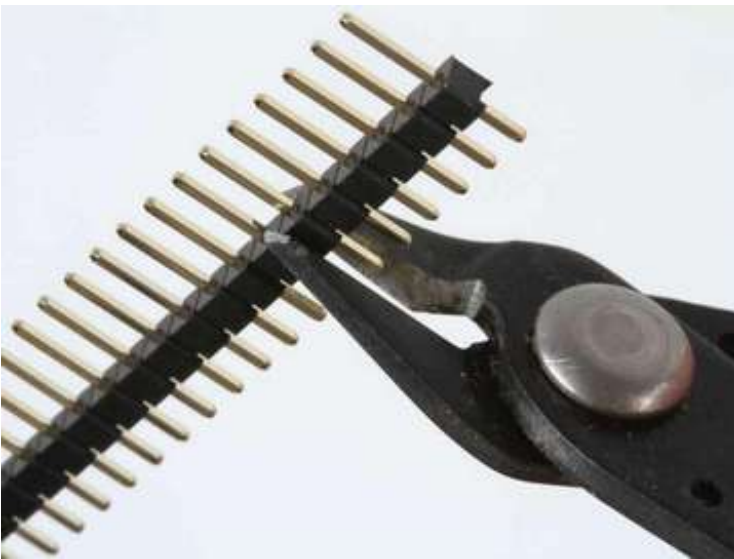

•

Cut to size first if necessary

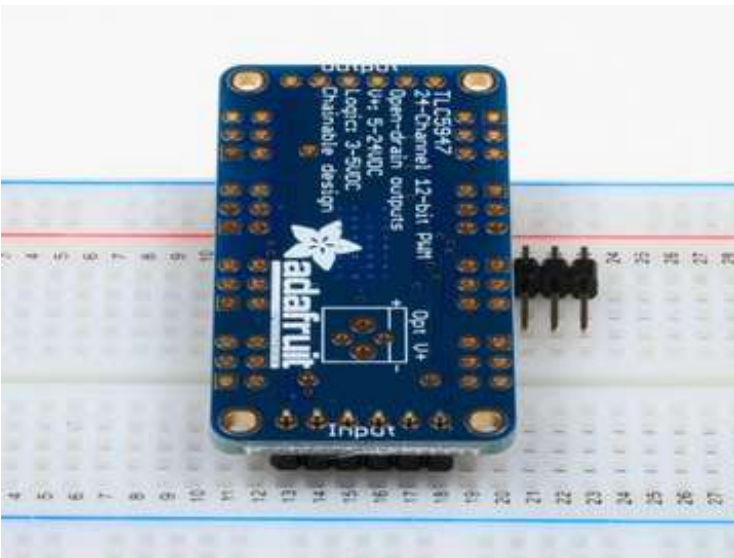

•

Position the board

Remember to place it upside down if you want the pins to end up on top.

Hint: A spare piece of header placed under the breakout board will help keep things aligned for soldering.

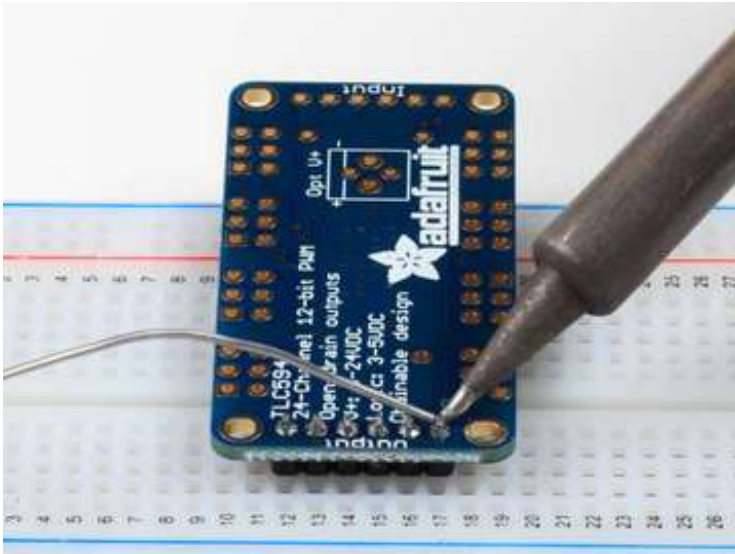

And solder!

Be sure to solder all pins for good electrical connection.

If you are new to soldering, check out the [Adafruit Guide to Excellent Soldering](http://adafru.it/aTk) (<http://adafru.it/aTk>)

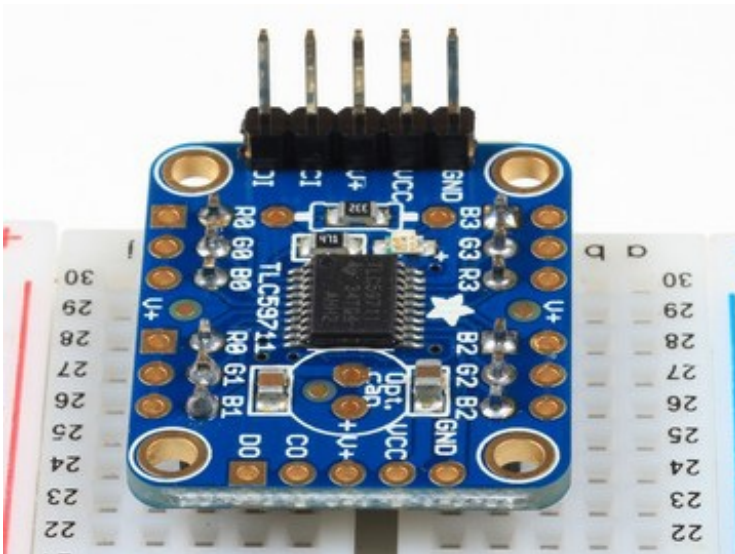

Repeat for the other side

Flip the board over and repeat the process for the LED headers on the bottom of the board.

Connecting to the Arduino

These boards communicate using an SPI protocol. The wiring is slightly different for the two boards, so we will describe them separately. For making breadboard connections with the header pins on top of the board, a set of [male-female jumpers](http://adafruit.it/826) (<http://adafruit.it/826>) are handy.

The pin configurations below are consistent with the example code supplied with the libraries:

24-Channel TLC5947

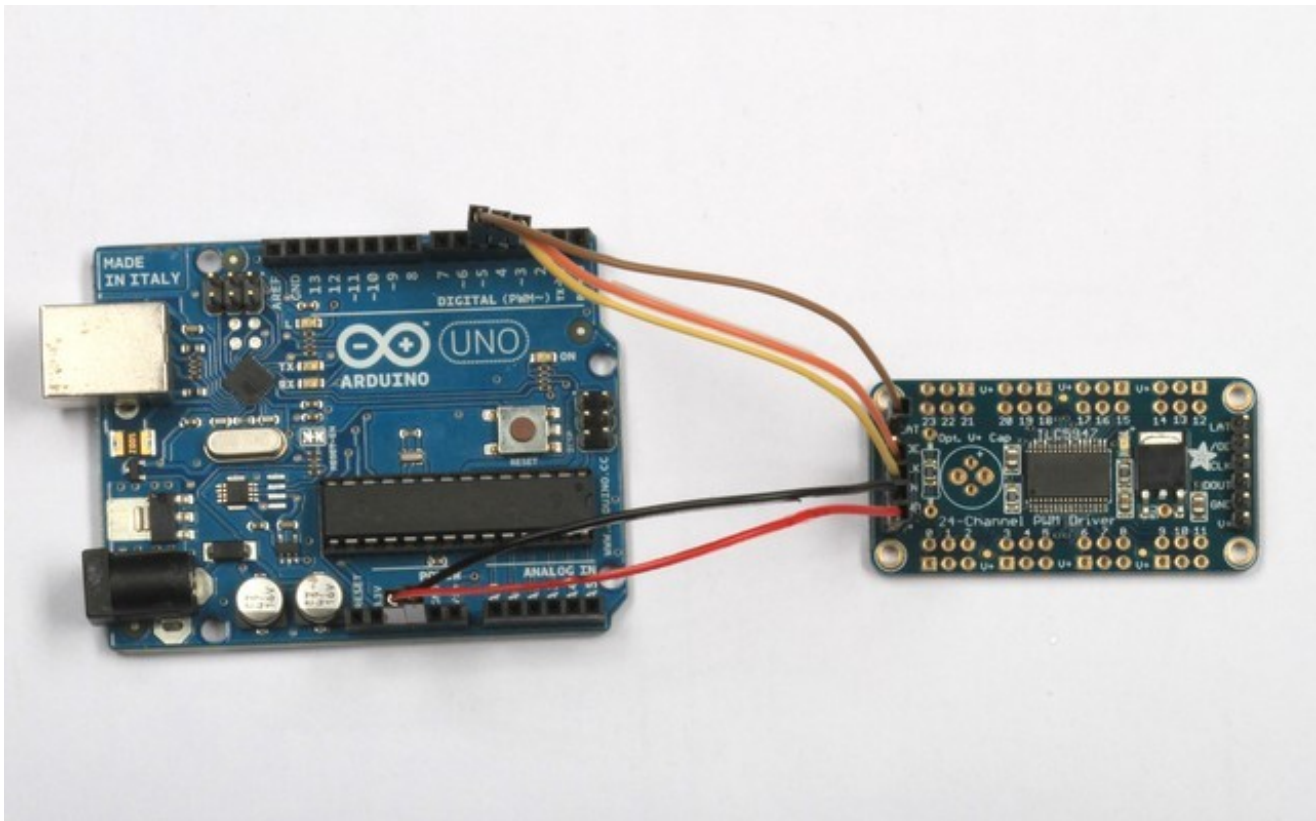

Connect to the Arduino as follows:

- **DIN -> Digital 4**
- **CLK -> Digital 5**
- **LAT -> Digital 6**
- **GND -> GND**

- **V+ -> VIN**

Here we show V+ connected to the Arduino VIN pin. This will power the breakout board and LED directly from the supply connected to the DC power jack. The TLC5947 can accept a V+ of 5v-30v. Higher voltages allow you to drive multiple LEDs in series from each channel.

The **DIN/CLK/LAT** pins can be changed to any other pins later

If you need V+ voltages higher than 12v, you will need to use a separate power supply. If you use a separate supply, be sure to connect the ground wire to the Arduino ground.

12-Channel TLC59711

You've got *two options* for powering/wiring your TLC59711

1. LEDs **V+** and logic level **VCC** connected together to 3 - 5V
2. LEDs **V+** at 4-17V and logic level **VCC** at 3.3V

If you need to use it with a 5V logic UNO, you can do **either of the following two wiring diagrams**:

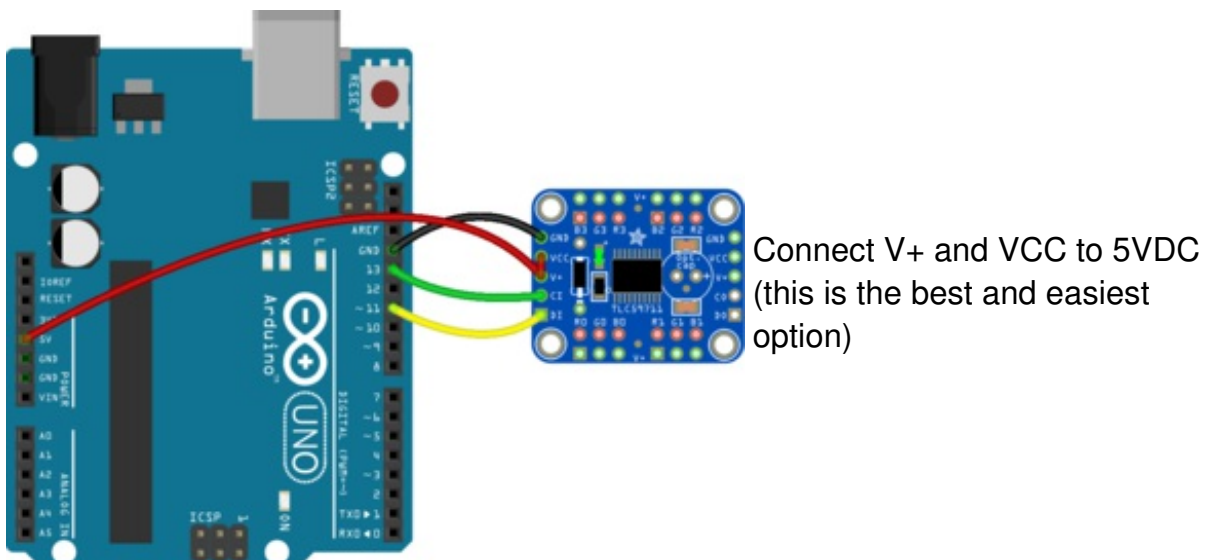

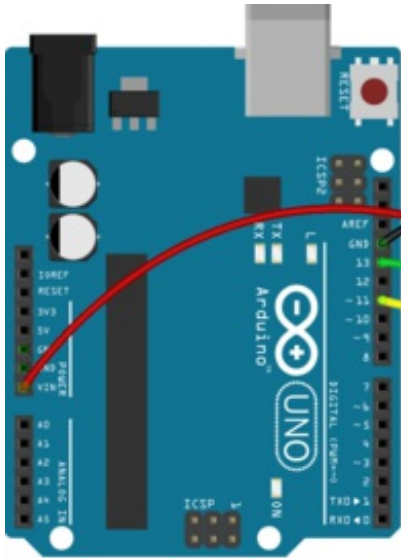

Connect V+ to 4-17V and keep VCC disconnected. Then use 10K resistors or a level shifter between the clock and data wires going into the *first* of the TLC59711

If you are using a 3.3V logic Arduino, you have two wiring options:

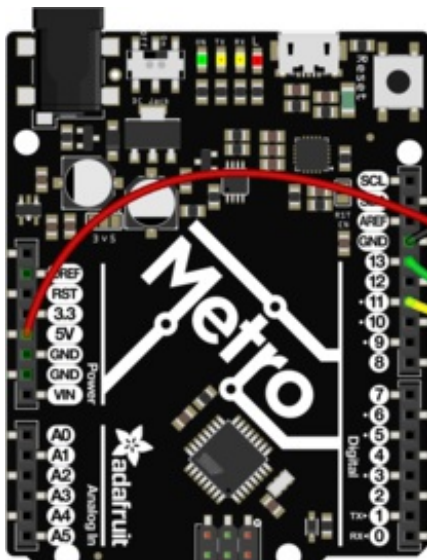

Keep **VCC** disconnected, and connect **V+** to **4-17V**

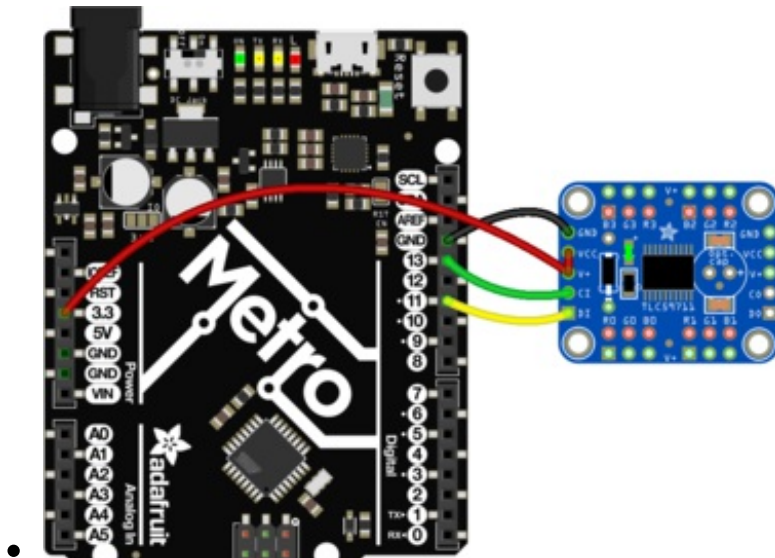

Connect **VCC** and **V+** together to 3.3V (if a 4V+ power source is not available)

Other than that, connect to the Arduino as follows:

- **DI -> Digital 11**
- **CI -> Digital 13**
- **GND -> GND**

The DI/CI pins can be changed to any other pins later

If you need V+ voltages higher than 12v, you will need to use a separate power supply. If you use a separate supply, be sure to connect the ground wire to the Arduino ground.

Chaining Boards

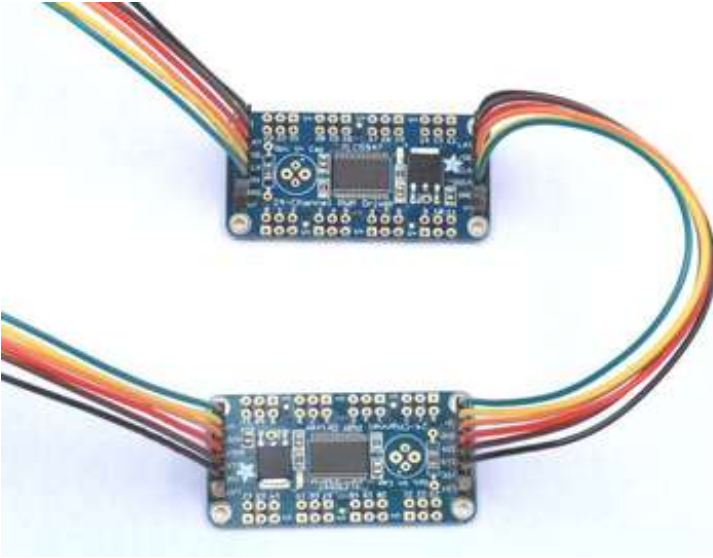

Multiple boards can be chained to control hundreds of LEDs. Using an Arduino, you will run out of memory long before you exceed the chaining capacity of these boards!

Header connections at both ends of the board make chaining simple. Our [6-Conductor 0.1" Socket-Socket Cable](http://adafru.it/206) (<http://adafru.it/206>) is perfect for linking them together.

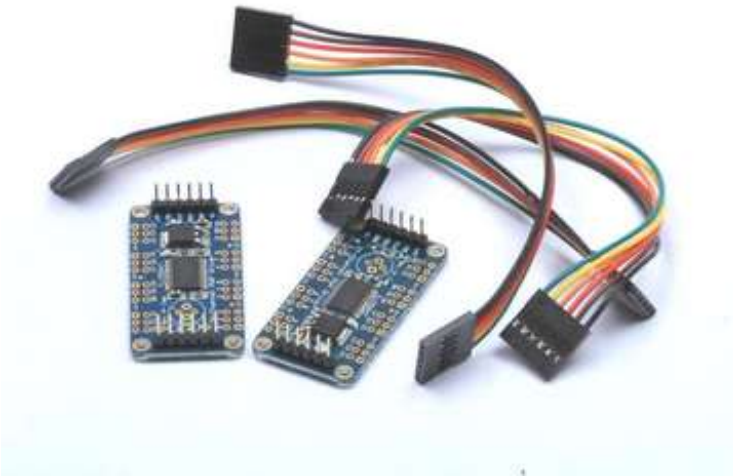

The next two pages will show you how to connect some LEDs and test them out with the library example sketch:

Power and LEDs

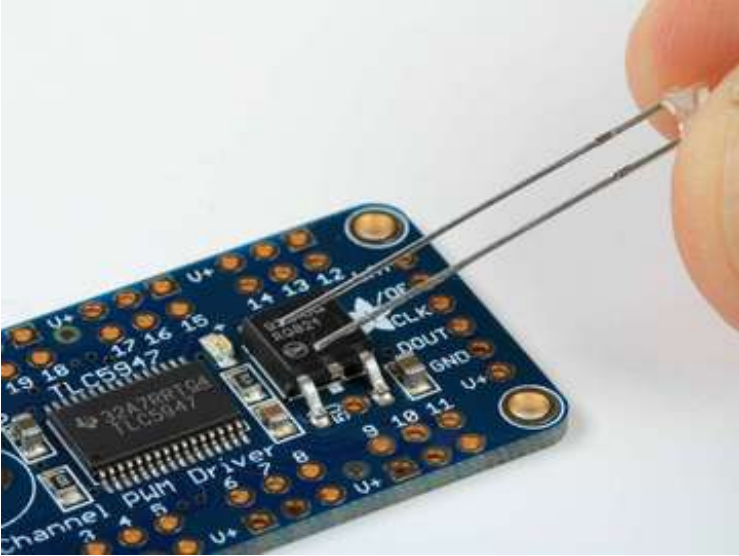

Connecting Monochrome LEDs

Note that one leg of the led is longer than the other. This is the Anode and should be connected to the V+ hole in the board.

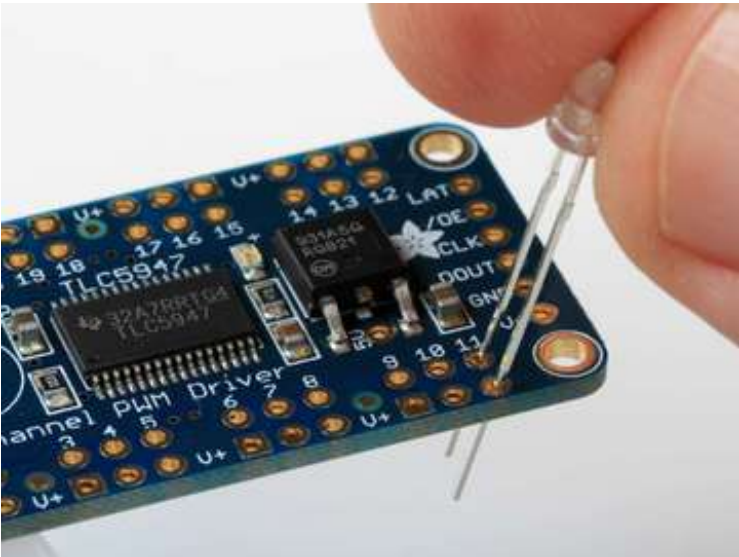



Off-Board Mounting

For more flexibility in positioning LEDs, you will probably want to connect your LEDs with wire instead of soldering them directly to your breakout board.



Our [Pig-Tail Cables](http://adafruit.it/1003) (<http://adafruit.it/1003>) make remote mounting of individual LEDs very simple.

You can also install headers onto the PCBs, then plug the pig-tail socket there, and solder the LED legs to the wire ends - whatever makes sense for your project

Tip: One strand of the pig-tail is marked in gray. Solder this to the V+ side to mark the polarity.



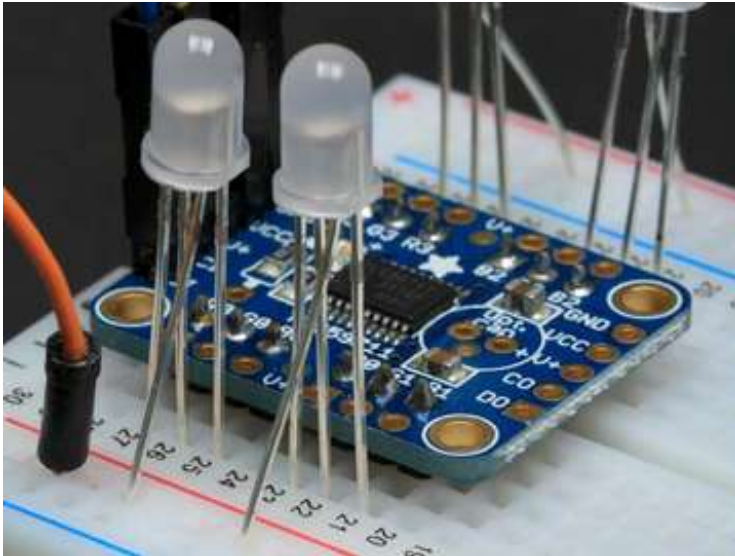

•

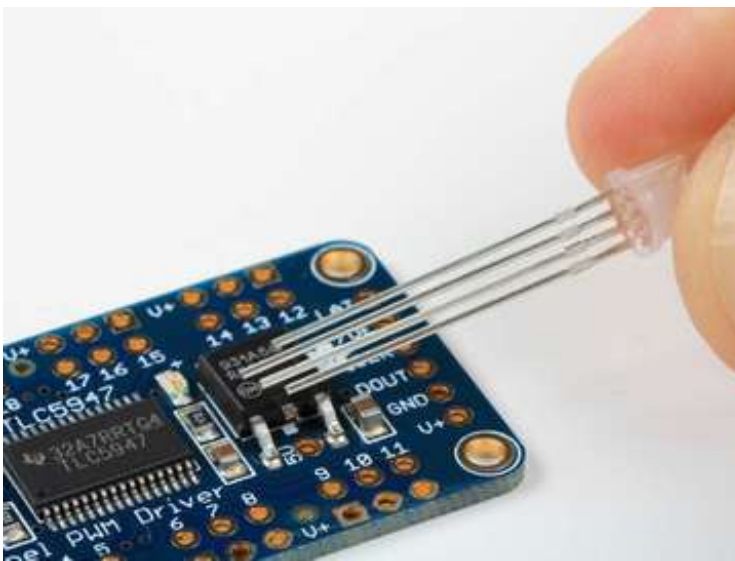

•

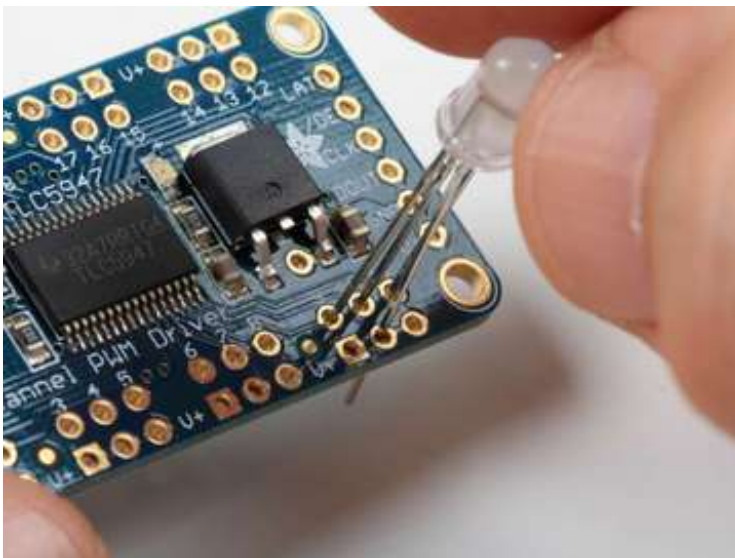

•

Connecting RGB LEDs

Output channels are conveniently arranged in groups of 3 to simplify connecting RGB leds.

The common anode (longest lead) should be soldered to one of the V+ holes (any one will do)

When working with a breadboard, connect V+ to the bus on the edge of the breadboard and plug the anode into the bus.

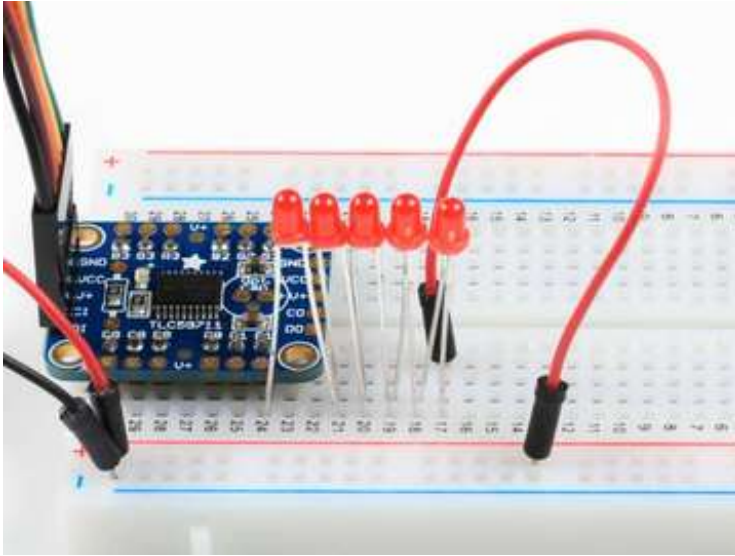

Multiple LEDs in Series

The wide voltage range and constant current drive makes it simple to drive multiple LEDs in series from any channel. Just be sure to choose a supply voltage is higher than the sum of the V_f s of all the leds in series.

For example: To drive 5 blue LEDs in series, you would need at least $3.2v * 5 = 16v$. This voltage is within the range of either the TLC59711 or the TLC5947.

Powering your LEDs

For running as many as 8 channels of RGB or 24 channels of single LEDs, you can usually get by borrowing power from the Arduino as shown. If you plan on running more LEDs with these boards, you should start thinking about how to power them.

Constant Current

Both the TLC59711 and TLC5947 are constant current drivers. This is just what LEDs need. Since they are constant current, you have some flexibility with the supply voltage and

you don't don't need to add current limiting resistors. The TLC59xxx drivers will adjust automatically to power supply fluctuations. Your LEDs won't flicker and you don't have to worry about burning them out. We have configured these breakouts to set the current level at 15mA per channel. This is a safe level for virtually all leds you might want to connect to them.

To operate at different currents, it is possible to replace the on-board reference resistor with a through-hole resistor. These drivers are capable of driving up to 60mA (TLC59711) or 30mA (TLC5947) per channel. The graphs in the data sheets show the relationship between resistance and output current.

[TLC59711 Data Sheet \(http://adafru.it/cZ0\)](http://adafru.it/cZ0)

[TLC5947 Data Sheet \(http://adafru.it/cZ1\)](http://adafru.it/cZ1)

Choosing a Supply Voltage

Since these are constant current drivers, the voltage selection is not so critical. It just needs to be slightly higher than the forward voltage (V_f) of your LEDs.

Supply Voltage Range:

- **TLC5947 - 5v to 30v**
- **TLC59711 - 5v to 17v**

Typical LED V_f by Color:

- **Red 2.1v**
- **Yellow 2.2v**
- **Green 3.2v**
- **Blue 3.2v**
- **White 3.2v**

Connecting an External Supply

If you do decide you need an external supply for your LEDs:

- First remove the connection between V_+ and V_{IN} from the Arduino.
- **Be sure to keep the connection between GND and the Arduino GND.**
- Next connect the negative terminal of your supply to GND on the breakout.
- Finally, connect the positive terminal of your supply to V_+ on the breakout.



Programming - Library Reference

Install The Library

To use these boards, first download and install the library using one of the buttons below. If you are new to Arduino Libraries, check this guide for instructions on how to install them:

<http://learn.adafruit.com/adafruit-all-about-arduino-libraries-install-use> (<http://adafru.it/aYM>)

[Adafruit TLC59711 Library Download](#)

<http://adafru.it/cZ2>

[Adafruit TLC5947 Library Download](#)

<http://adafru.it/cZ3>

Run the Example Code

Wire your breakout and connect some LEDs as shown on the previous pages. Load the example code for your breakout board:

File->Examples->Adafruit_59711->tlc59711test

or:

File->Examples->Adafruit_5947->tlc5947test

And run. If you are using RGB LEDs, the code will cycle through some colors to demonstrate the capabilities of the board.

TLC5947 Library Reference:

Adafruit_TLC5947(uint8_t n, uint8_t c, uint8_t d, uint8_t l)

Call the constructor to create an instance of the TLC5947 PWM breakout driver.

- n = Number of Drivers (>1 if the drivers are chained)
- c = Clock pin
- d = Data pin
- l = Latch pin

boolean begin(void);

Call begin just once in your setup() function to initialize the devices.

void setPWM(uint8_t chan, uint16_t pwm);

Call this to set the PWM level for a channel.

- chan = Channel
- pwm = PWM level (0 = minimum, 4095 = maximum)

void setLED(uint8_t lednum, uint16_t r, uint16_t g, uint16_t b);

Call this to set the RGB value for a group of 3 channels

- lednum = LED number (channel number of the "red" pin divided by 3)
- r = red level
- g = green level
- b = blue level

void write(void);

Call this after every change to write the new PWM levels to the device.

TLC59711 Library Reference:

Adafruit_TLC59711(uint8_t n, uint8_t c, uint8_t d);

Call the constructor to create an instance of the TLC59711 PWM breakout driver.

- n = Number of Drivers (>1 if the drivers are chained)
- c = Clock Pin
- D = Data Pin

Adafruit_TLC59711(uint8_t n);

Alternate constructor for hardware SPI. Assumes hardware SPI pins for MOSI and SCK.

boolean begin(void);

Call begin just once in your setup() function to initialize the devices.

void setPWM(uint8_t chan, uint16_t pwm);

Call this to set the PWM level for a channel.

- chan = Channel
- pwm = PWM level (0 = minimum, 65535= maximum)

void setLED(uint8_t lednum, uint16_t r, uint16_t g, uint16_t b);

Call this to set the RGB value for a group of 3 channels

- lednum = LED number (channel number of the "red" pin divided by 3)
- r = red level
- g = green level
- b = blue level

void write(void);

Call this after every change to write the new PWM levels to the device.



Downloads and Links

Libraries:

[TLC59711 Library \(http://adafru.it/cZ2\)](http://adafru.it/cZ2) (12 channel breakout)

[TLC5947 Library \(http://adafru.it/cZ3\)](http://adafru.it/cZ3) (24 channel breakout)

For tips on installing Arduino Libraries, see our guide: [All About Arduino Libraries \(http://adafru.it/aYM\)](http://adafru.it/aYM).

Data Sheets & Files

- [TLC59711 Data Sheet \(http://adafru.it/cZ0\)](http://adafru.it/cZ0)
- [TLC5947 Data Sheet \(http://adafru.it/cZ1\)](http://adafru.it/cZ1)
- [Fritzing objects in Adafruit Fritzing Library \(http://adafru.it/aP3\)](http://adafru.it/aP3)
- [EagleCAD PCB files for TLC5947 on GitHub \(http://adafru.it/rB5\)](http://adafru.it/rB5)
- [EagleCAD PCB files for TLC59711 on GitHub \(http://adafru.it/rB6\)](http://adafru.it/rB6)

TLC5947 Schematic & Print

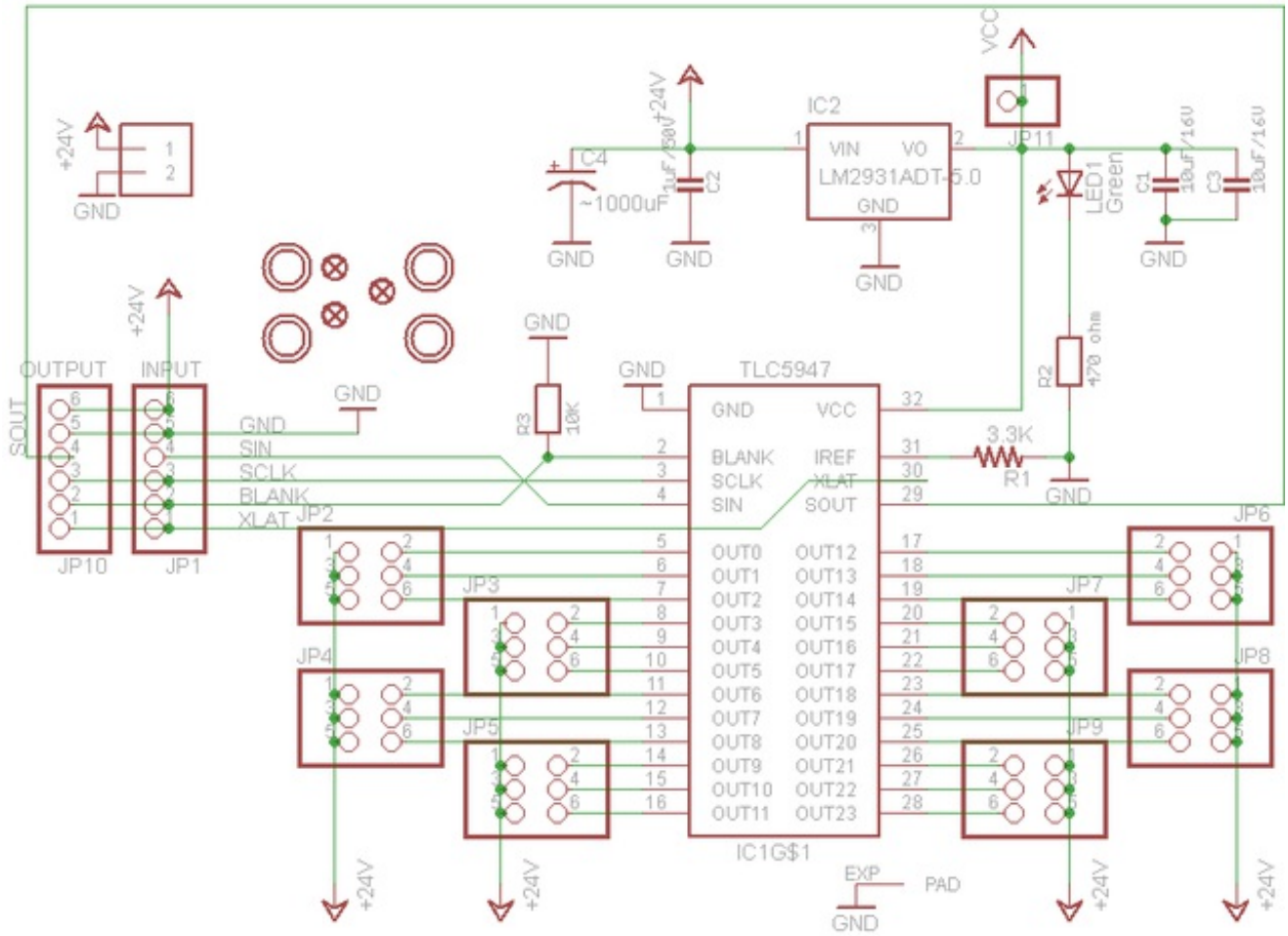

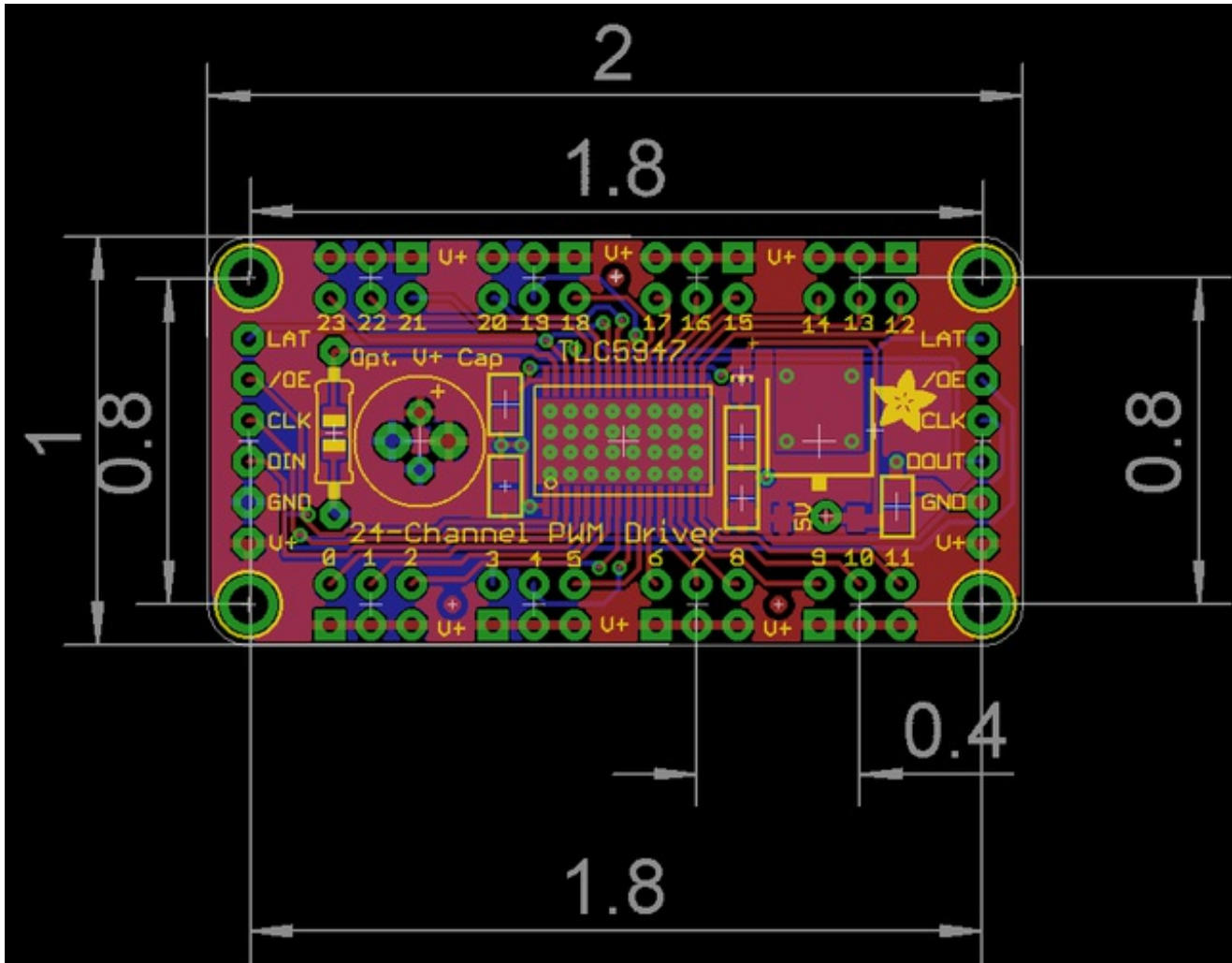

TLC59711 Schematic and Print

