

PLEASE CHECK WWW.MOLEX.COM FOR LATEST PART INFORMATION

Part Number: [19019-0054](#)
Status: **Active**
Description: Avikrimp™ Quick Disconnect, Female, for 12-14 (3.30-2.00mm²) Wire, Mylar Tape, Tab 6.35 x 0.81mm

Documents:

[Drawing \(PDF\)](#) [Product Specification PS-19902-015 \(PDF\)](#)
[Product Specification PS-19902-011 \(PDF\)](#) [RoHS Certificate of Compliance \(PDF\)](#)
[Product Specification PS-19902-014 \(PDF\)](#)

Agency Certification

CSA LR18689
 UL E79133

General

Product Family Quick Disconnects
 Series [19019](#)
 Crimp Quality Equipment Yes
 Product Name Avikrimp™
 Type Quick Disconnect
 UPC 800753038592

Physical

Barrel Type Closed
 Flammability 94V-2
 Gender Female
 Glow-Wire Compliant No
 Insulation Nylon (PA)
 Lock to Mating Part None
 Material - Metal Brass
 Net Weight 1.145/g
 Orientation Straight
 Packaging Type Adhesive Tape on Reel
 Polarized to Mating Part No
 Tab Thickness 0.81mm
 Tab Width 6.35mm
 Temperature Range - Operating -65°C to +105°C
 Wire Insulation Diameter 4.30mm max.
 Wire Size AWG 12, 14
 Wire Size mm² 2.00 - 3.30

Electrical

Voltage - Maximum 300V

Material Info

Old Part Number P-8142T

Reference - Drawing Numbers

Product Specification PS-19902-011, PS-19902-014, PS-19902-015
 Sales Drawing SD-19019-001

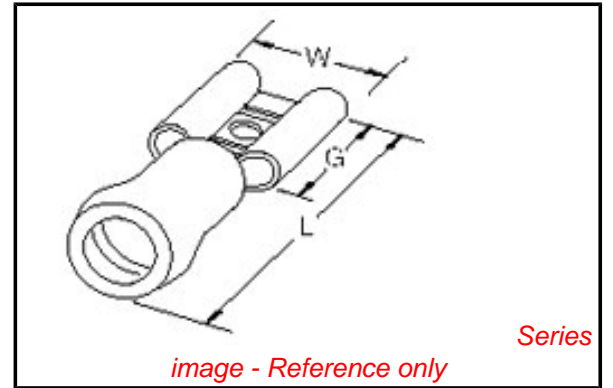

EU RoHS

ELV and RoHS Compliant
REACH SVHC
 Not Reviewed
Low-Halogen Status
Low-Halogen

China RoHS



Need more information on product environmental compliance?

Email productcompliance@molex.com
 For a multiple part number RoHS Certificate of Compliance, [click here](#)

Please visit the [Contact Us](#) section for any non-product compliance questions.

Search Parts in this Series

19019Series

Application Tooling | FAQ

Tooling specifications and manuals are found by selecting the products below. Crimp Height Specifications are then contained in the Application Tooling Specification document.

Global

Description	Product #
Crimp Dies for MTA-100 Tape Applicator used in 3BF Press, MTA-105 Tape Applicator used in TM-2000™ Press, and ATP-301 Air Crimping Press for Mylar Tape Mounted Terminals Mini-Mac™	0192880254
Applicator	0638853100

This document was generated on 01/14/2013

PLEASE CHECK WWW.MOLEX.COM FOR LATEST PART INFORMATION