





CERAMIC RF CHIP INDUCTORS – 0402CC SERIES



-  Monolithic inorganic material construction
-  Low DC resistance and high Q Values at high frequency
-  High Self Resonant Frequency
-  Industry Standard 0402 (1005) Surface Mount Land Pattern

Electrical Specifications @ 25°C

Part Number	Inductance (nH)	Standard Tolerance	Q (Min.)	Test Frequency (MHz)	SRF (MHz MIN)	R _{dc} (Ω MAX)	I _{dc} (mA MAX)
PE-0402CC1N0STT	1.0	±0.3nH (S)	8	100	10000	0.08	300
PE-0402CC1N2STT	1.2	±0.3nH (S)	8	100	10000	0.09	300
PE-0402CC1N5STT	1.5	±0.3nH (S)	8	100	6000	0.1	300
PE-0402CC1N8STT	1.8	±0.3nH (S)	8	100	6000	0.12	300
PE-0402CC2N0STT	2.0	±0.3nH (S)	8	100	6000	0.12	300
PE-0402CC2N2STT	2.2	±0.3nH (S)	8	100	6000	0.13	300
PE-0402CC2N4STT	2.4	±0.3nH (S)	8	100	6000	0.13	300
PE-0402CC2N7STT	2.7	±0.3nH (S)	8	100	6000	0.13	300
PE-0402CC3N0STT	3.0	±0.3nH (S)	8	100	6000	0.16	300
PE-0402CC3N3STT	3.3	±0.3nH (S)	8	100	6000	0.16	300
PE-0402CC3N6STT	3.6	±0.3nH (S)	8	100	5000	0.20	300
PE-0402CC3N9STT	3.9	±0.3nH (S)	8	100	4000	0.21	300
PE-0402CC4N36STT	4.3	±0.3nH (S)	8	100	4000	0.20	300
PE-0402CC4N7STT	4.7	±0.3nH (S)	8	100	4000	0.21	300
PE-0402CC5N1STT	5.1	±0.3nH (S)	8	100	4000	0.21	300
PE-0402CC5N6STT	5.6	±0.3nH (S)	8	100	4000	0.23	300
PE-0402CC6N2STT	6.2	±0.3nH (S)	8	100	3900	0.25	300
PE-0402CC6N8JTT	6.8	±5% (J)	8	100	3900	0.25	300
PE-0402CC7N5JTT	7.5	±5% (J)	8	100	3700	0.25	300
PE-0402CC8N2JTT	8.2	±5% (J)	8	100	3600	0.28	300
PE-0402CC9N1JTT	9.1	±5% (J)	8	100	3400	0.30	300
PE-0402CC100JTT	10	±5% (J)	8	100	3200	0.31	300
PE-0402CC120JTT	12	±5% (J)	8	100	2700	0.4	300
PE-0402CC150JTT	15	±5% (J)	8	100	2300	0.46	300
PE-0402CC180JTT	18	±5% (J)	8	100	2100	0.55	300
PE-0402CC220JTT	22	±5% (J)	8	100	1900	0.6	300
PE-0402CC270JTT	27	±5% (J)	8	100	1600	0.7	300
PE-0402CC330JTT	33	±5% (J)	8	100	1300	0.8	200

Electrical Specifications @ 25°C

Part Number	Inductance (nH)	Standard Tolerance	Q (Min.)	Test Frequency (MHz)	SRF (MHz MIN)	R _{DC} (Ω MAX)	I _{bc} (mA MAX)
PE-0402CC390JTT	39	±5% (J)	8	100	1200	0.9	200
PE-0402CC470JTT	47	±5% (J)	8	100	1000	1.0	200
PE-0402CC560JTT	56	±5% (J)	8	100	750	1.0	200
PE-0402CC680JTT	68	±5% (J)	8	100	750	1.2	180
PE-0402CC820JTT	82	±5% (J)	8	100	600	1.3	150
PE-0402CC101JTT	100	±5% (J)	8	100	600	1.5	150
PE-0402CC121JTT	120	±5% (J)	8	100	600	1.6	150
PE-0402CC151JTT	150	±5% (J)	8	100	550	3.2	140
PE-0402CC181JTT	180	±5% (J)	8	100	500	3.7	130
PE-0402CC221JTT	220	±5% (J)	8	100	450	4.2	120
PE-0402CC271JTT	270	±5% (J)	8	100	400	4.8	110

Mechanical

0402CC Series

$\frac{0.0098 \pm 0.0039}{0.25 \pm 0.10}$

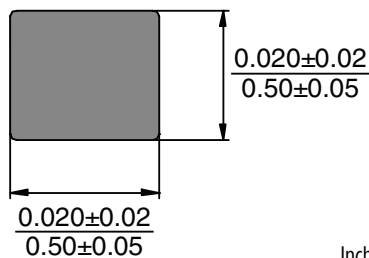
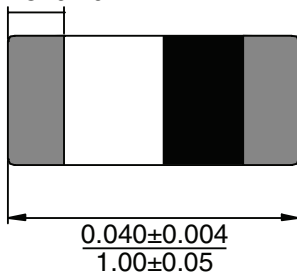

Dimensions: $\frac{\text{Inches}}{\text{mm}}$

Unless otherwise specified, all tolerances are $\pm \frac{.010}{0,25}$

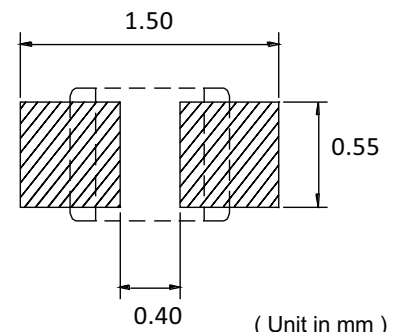

Suggested PCB LAND PATTERN

CERAMIC RF CHIP INDUCTORS – 0402CC SERIES

Characteristic Graphs

0402CC Series

Impedance v.s. Frequency Characteristics

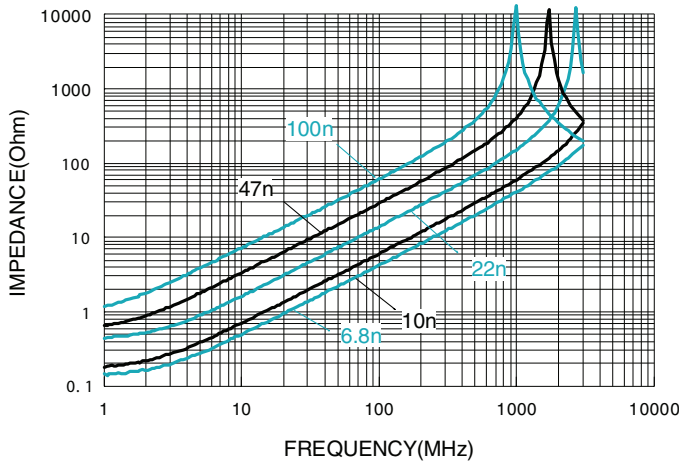

Inductance v.s. Frequency Characteristics

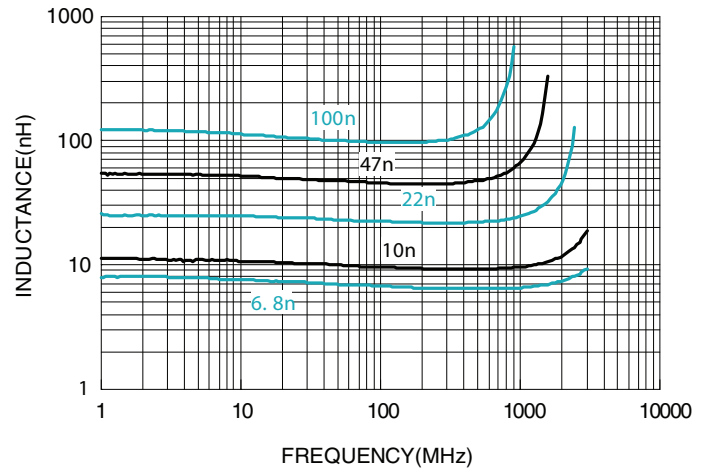

Q v.s. Frequency Characteristics

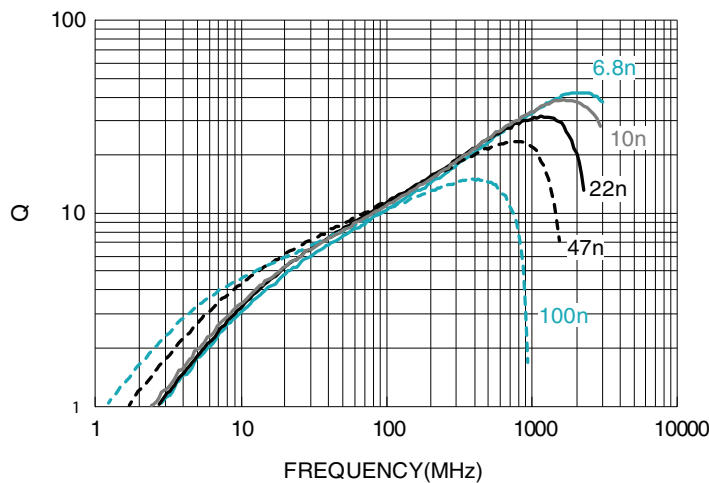

For More Information

Pulse Worldwide Headquarters

12220 World Trade Drive
San Diego, CA 92128
U.S.A.

Tel: 858 674 8100
Fax: 858 674 8262

Pulse Europe

Zeppelinstrasse 15
71083 Herrenberg
Germany

Tel: 49 7032 7806 0
Fax: 49 7032 7806 12

Pulse China Headquarters

B402, Shenzhen Academy of
Aerospace Technology Bldg.
10th Kejian Road
High-Tech Zone
Nanshan District
Shenzhen, PR China 518057

Tel: 86 755 33966678
Fax: 86 755 33966700

Pulse North China

Room 2704/2705
Super Ocean Finance Ctr.
2067 Yan An Road West
Shanghai 200336
China

Tel: 86 21 62787060
Fax: 86 2162786973

Pulse South Asia

135 Joo Seng Road
#03-02
PM Industrial Bldg.
Singapore 368363

Tel: 65 6287 8998
Fax: 65 6287 8998

Pulse North Asia

3F, No. 198
Zhongyuan Road
Zhongli City
Taoyuan County 320
Taiwan R. O. C.

Tel: 886 3 4356768
Fax: 886 3 4356823 (Pulse)
Fax: 886 3 4356820 (FRE)

Performance warranty of products offered on this data sheet is limited to the parameters specified. Data is subject to change without notice. Other brand and product names mentioned herein may be trademarks or registered trademarks of their respective owners. © Copyright, 2014. Pulse Electronics, Inc. All rights reserved.