

Part Number: APB2012SURKSYKC

Hyper Red
Super Bright Yellow

Features

- 2.0mmx1.25mm SMT LED, 1.1mm thickness.
- Bi -color, Low power consumption.
- Wide viewing angle.
- Ideal for backlight and indicator.
- Package : 2000pcs / reel.
- Moisture sensitivity level : level 3.
- RoHS compliant.

Description

The Hyper Red source color devices are made with Al-GaN on GaAs substrate Light Emitting Diode. The Super Bright Yellow device is made with AlGaInP (on GaAs substrate) light emitting diode chip.

Package Dimensions

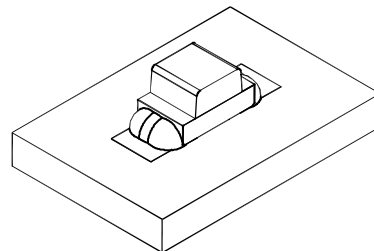
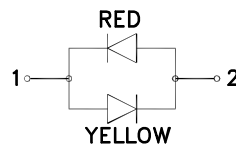
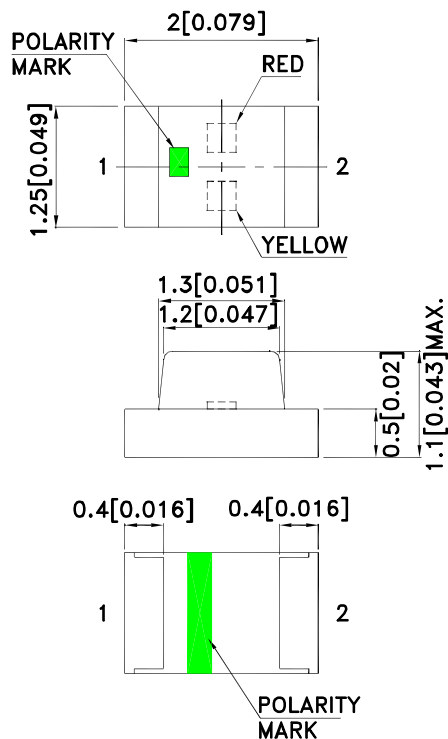

Notes:

1. All dimensions are in millimeters (inches).
2. Tolerance is $\pm 0.15(0.006)$ unless otherwise noted.
3. The specifications, characteristics and technical data described in the datasheet are subject to change without prior notice.
4. The device has a single mounting surface. The device must be mounted according to the specifications.



Selection Guide

Part No.	Dice	Lens Type	Iv (mcd) [2] @ 20mA		Viewing Angle [1]
			Min.	Typ.	2θ1/2
APB2012SURKSYKC	Hyper Red (AlGaInP)	Water Clear	120	200	150°
			*40	*80	
	Super Bright Yellow (AlGaInP)		80	120	
			*80	*120	

Notes:

1. θ1/2 is the angle from optical centerline where the luminous intensity is 1/2 of the optical peak value.
2. Luminous intensity/ luminous Flux: +/-15%.
- * Luminous intensity value is traceable to the CIE127-2007 compliant national standards.

Electrical / Optical Characteristics at TA=25°C

Symbol	Parameter	Device	Typ.	Max.	Units	Test Conditions
λ _{peak}	Peak Wavelength	Hyper Red Super Bright Yellow	645 590		nm	I _F =20mA
λ _D [1]	Dominant Wavelength	Hyper Red Super Bright Yellow	630 590		nm	I _F =20mA
Δλ _{1/2}	Spectral Line Half-width	Hyper Red Super Bright Yellow	28 20		nm	I _F =20mA
C	Capacitance	Hyper Red Super Bright Yellow	35 20		pF	V _F =0V;f=1MHz
V _F [2]	Forward Voltage	Hyper Red Super Bright Yellow	1.95 2	2.5 2.5	V	I _F =20mA

Notes:

1. Wavelength: +/-1nm.
2. Forward Voltage: +/-0.1V.
3. Wavelength value is traceable to the CIE127-2007 compliant national standards.

Absolute Maximum Ratings at TA=25°C

Parameter	Hyper Red	Super Bright Yellow	Units
Power dissipation	75	75	mW
DC Forward Current	30	30	mA
Peak Forward Current [1]	185	175	mA
Operating Temperature	-40°C To +85°C		
Storage Temperature	-40°C To +85°C		

Note:

1. 1/10 Duty Cycle, 0.1ms Pulse Width.

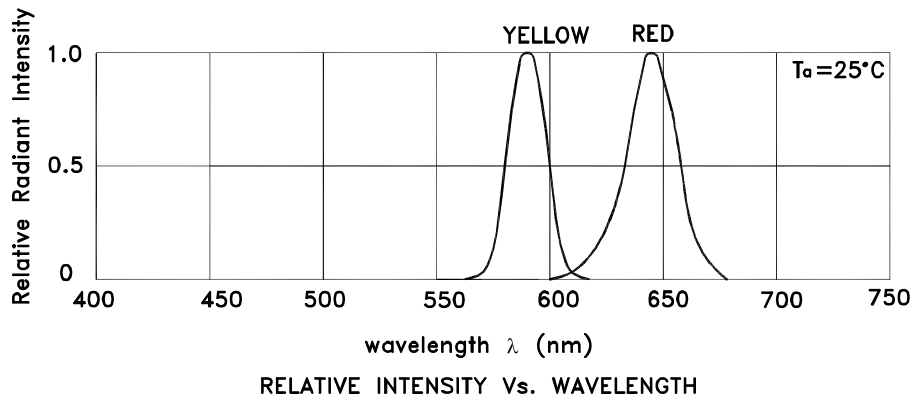

APB2012SURKSYKC
Hyper Red

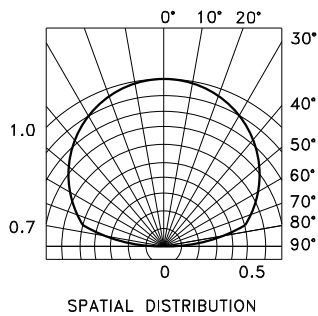
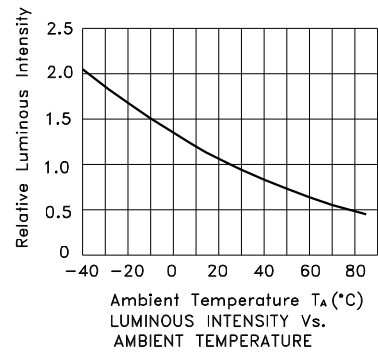
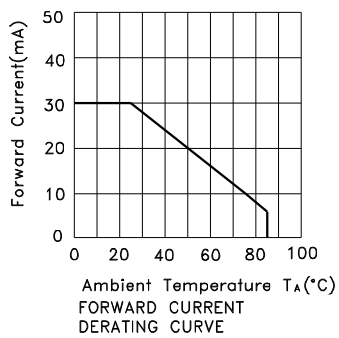
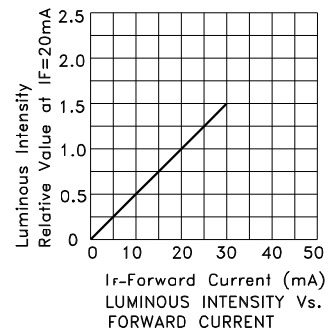
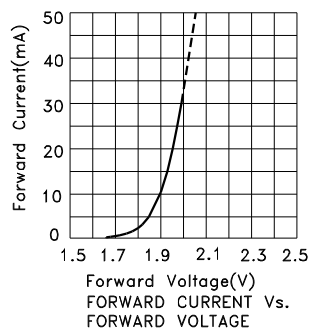

Kingbright

Super Bright Yellow

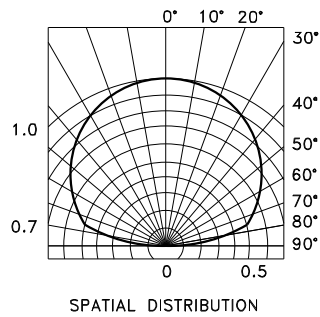
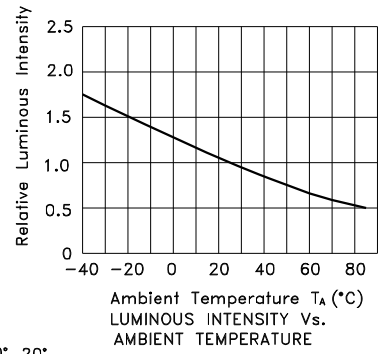
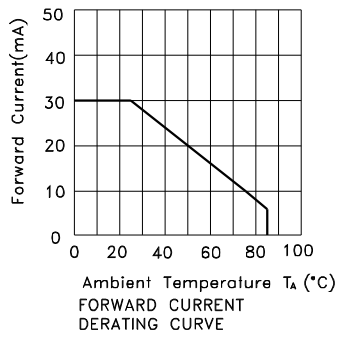
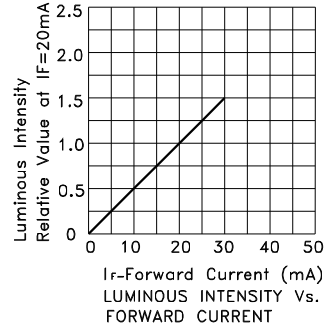
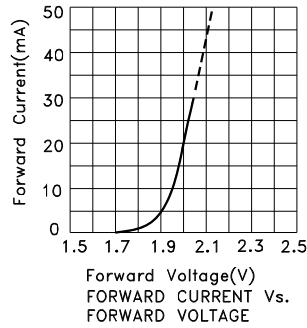

APB2012SURKSYKC

Reflow soldering is recommended and the soldering profile is shown below.
Other soldering methods are not recommended as they might cause damage to the product.

Reflow Soldering Profile For Lead-free SMT Process.



NOTES:

1. We recommend the reflow temperature 245°C(+/-5°C). The maximum soldering temperature should be limited to 260°C.
2. Don't cause stress to the epoxy resin while it is exposed to high temperature.
3. Number of reflow process shall be 2 times or less.

Recommended Soldering Pattern (Units : mm; Tolerance: ± 0.1)

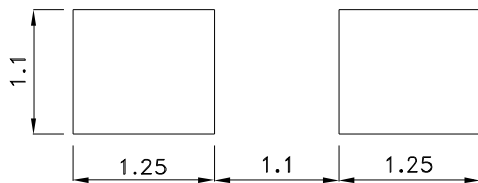

Reel Dimension



Tape Dimensions (Units : mm)

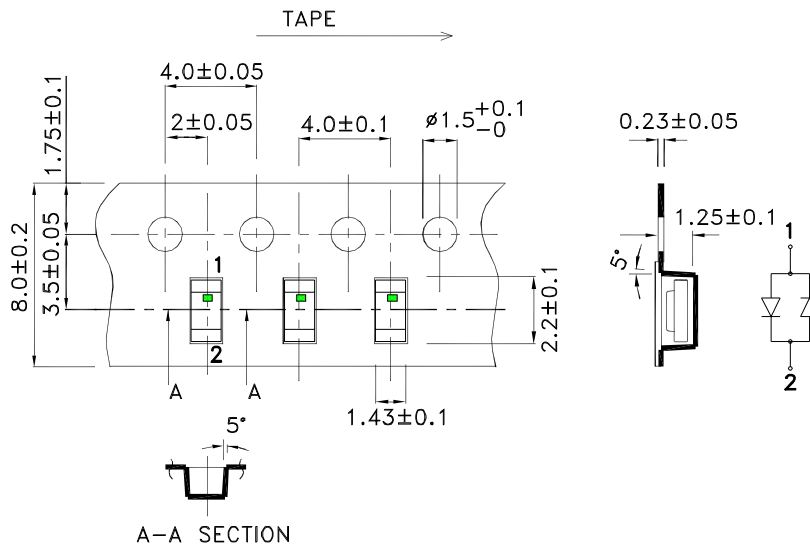

Kingbright

PACKING & LABEL SPECIFICATIONS

APB2012SURKSYKC

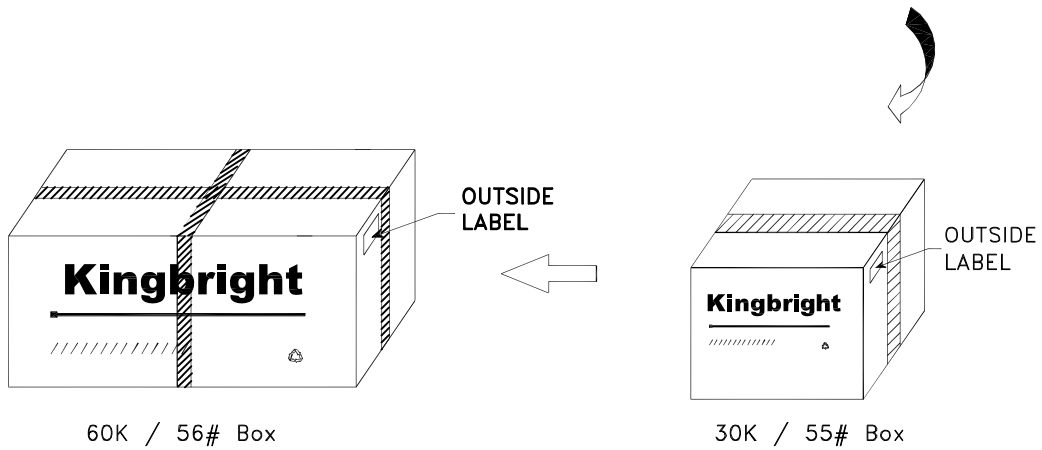
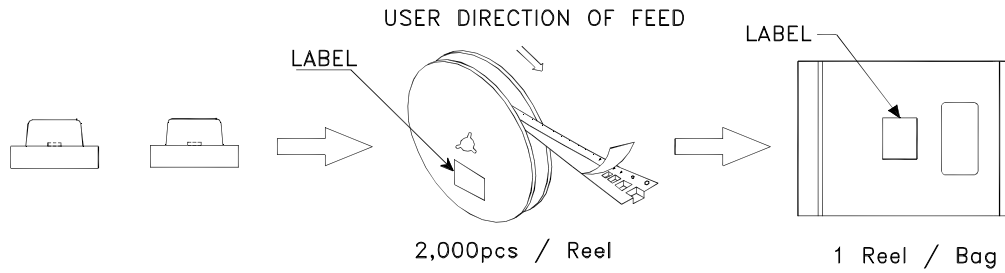

<h1>Kingbright</h1>	
P/NO: APB2012xxx	
QTY: 2,000 pcs	Q.C. QC XX XX XXXX PASSED
S/N: XXXX	
CODE: XXX	
LOT NO:	
 <small>xxxxxxxxxxxxxxxxxxxxxxxxxxxxxxxx</small>	
RoHS Compliant	

All design applications should refer to Kingbright application notes available at <http://www.KingbrightUSA.com/ApplicationNotes>