

DESIGN A STYLISH LAMP WITH THIS

Micro USB Lamp Kit

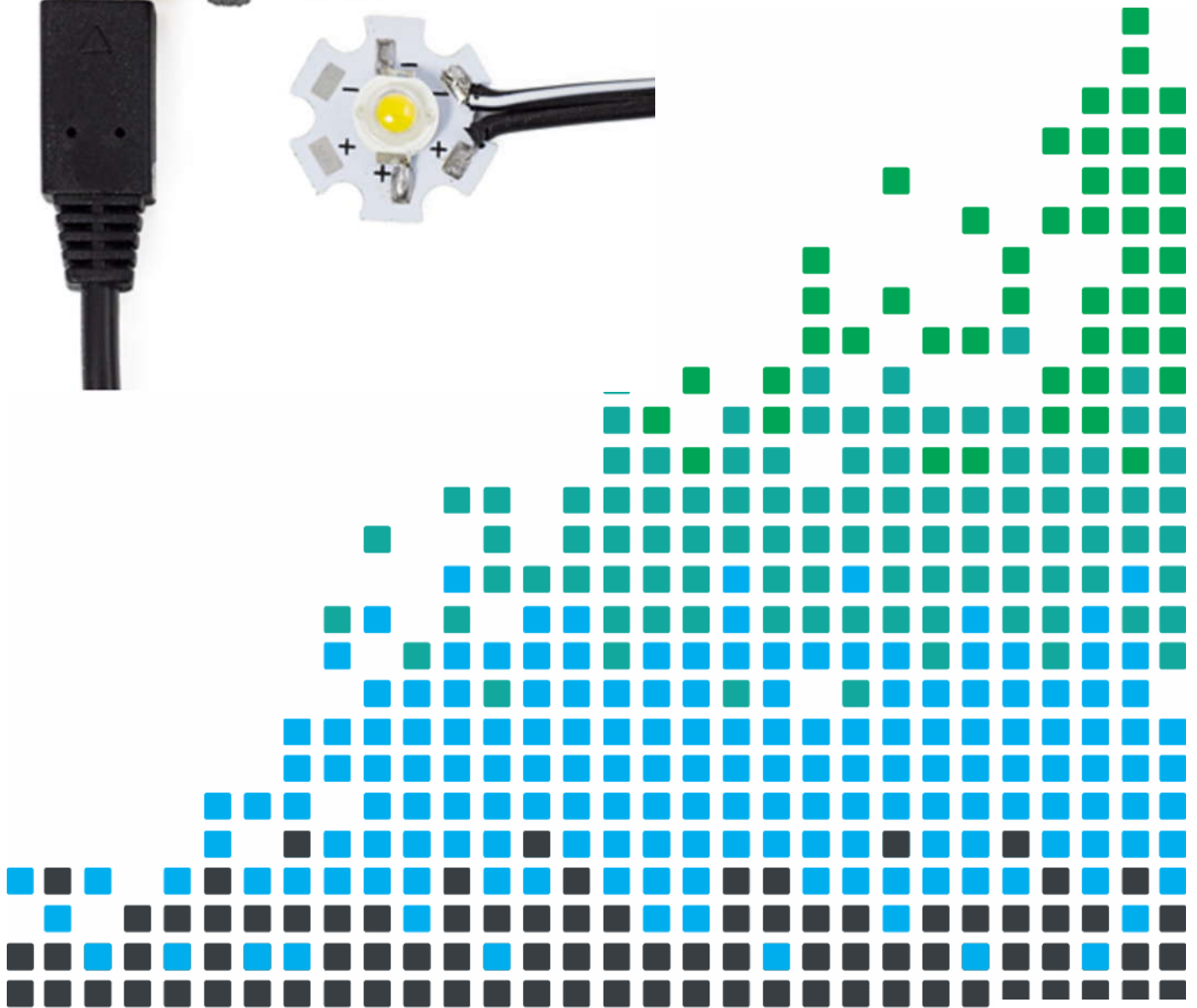

Index of Sheets

TEACHING RESOURCES

- Index of Sheets
- Introduction
- Schemes of Work
- Answers
- The Design Process
- The Design Brief
- Investigation / Research
- Developing a Specification
- Design
- Design Review (group task)
- Soldering in Ten Steps
- Resistor Values
- LEDs & Current Limit Resistors
- LEDs Continued
- Instruction Manual
- Evaluation
- Packaging Design

ESSENTIAL INFORMATION

- Build Instructions
- Checking Your Micro USB Lamp PCB
- How the Micro USB Lamp Works
- Designing the Enclosure
- Online Information



Introduction

About the project kit

Both the project kit and the supporting material have been carefully designed for use in KS3 Design and Technology lessons. The project kit has been designed so that even teachers with a limited knowledge of electronics should have no trouble using it as a basis from which they can form a scheme of work.

The project kits can be used in two ways:

1. As part of a larger project involving all aspects of a product design, such as designing an enclosure for the electronics to fit into.
2. On their own as a way of introducing electronics and electronic construction to students over a number of lessons.

This booklet contains a wealth of material to aid the teacher in either case.

Using the booklet

The first few pages of this booklet contains information to aid the teacher in planning their lessons and also covers worksheet answers. The rest of the booklet is designed to be printed out as classroom handouts. In most cases all of the sheets will not be needed, hence there being no page numbers, teachers can pick and choose as they see fit.

Please feel free to print any pages of this booklet to use as student handouts in conjunction with Kitronik project kits.

Support and resources

You can also find additional resources at www.kitronik.co.uk. There are component fact sheets, information on calculating resistor and capacitor values, puzzles and much more.

Kitronik provide a next day response technical assistance service via e-mail. If you have any questions regarding this kit or even suggestions for improvements, please e-mail us at:

support@kitronik.co.uk

Alternatively, phone us on 0845 8380781.



Schemes of Work

Two schemes of work are included in this pack; the first is a complete project including the design & manufacture of an enclosure for the kit (below). The second is a much shorter focused practical task covering just the assembly of the kit (next page). Equally, feel free to use the material as you see fit to develop your own schemes.

Before starting we would advise that you to build a kit yourself. This will allow you to become familiar with the project and will provide a unit to demonstrate.

Complete product design project including electronics and enclosure

Hour 1	Introduce the task using 'The Design Brief' sheet. Demonstrate a built unit. Take students through the design process using 'The Design Process' sheet. Homework: Collect examples of lighting products including some lamps. List the common features of these products on the 'Investigation / research' sheet.
Hour 2	Develop a specification for the project using the 'Developing a Specification' sheet. Resource: Sample of lamps and lighting products. Homework: Using the internet or other search method find out what is meant by design for manufacture. List five reasons why design for manufacture should be considered on any design project.
Hour 3	Read 'Designing the Enclosure' sheet. Develop a product design using the 'Design' sheet. Homework: Complete design.
Hour 4	Using cardboard get the students to model their enclosure design. Allow them to make alterations to their design if the model shows any areas that need changing.
Hour 5	Split the students into groups and get them to perform a group design review using the 'Design Review' sheet.
Hour 6	Using the 'Soldering in Ten Steps' sheet demonstrate and get students to practice soldering. Start the 'Resistor Value' work sheet and the information on 'LEDs & Current Limit Resistors'. Homework: Complete any of the remaining resistor tasks.
Hour 7	Build the electronic kit using the 'Build Instructions'.
Hour 8	Complete the build of the electronic kit. Check the completed PCB and fault find if required using the 'Checking Your Micro USB Lamp PCB' section. Homework: Read 'How the USB Lamp Works' sheet in conjunction with the LED sheet.
Hour 9	Build the enclosure.
Hour 10	Build the enclosure.
Hour 11	Build the enclosure.
Hour 12	Using the 'Evaluation' and 'Improvement' sheet, get the students to evaluate their final product and state where improvements can be made.

Additional Work

Package design for those who complete ahead of others.



Electronics only

Hour 1	Introduction to the kit demonstrating a built unit. Using the 'Soldering in Ten Steps' sheet, practice soldering.
Hour 2	Build the kit using the 'Build Instructions'.
Hour 3	Check the completed PCB and fault find if required using 'Checking Your Micro USB Lamp PCB'

Answers

Resistor questions

1st Band	2nd Band	Multiplier x	Value
Brown	Black	Yellow	100,000 Ω
Green	Blue	Brown	560 Ω
Brown	Grey	Yellow	180,000 Ω
Orange	White	Black	39 Ω

Value	1st Band	2nd Band	Multiplier x
180 Ω	Brown	Grey	Brown
3,900 Ω	Orange	White	Red
47,000 (47K) Ω	Yellow	Violet	Orange
1,000,000 (1M) Ω	Brown	Black	Green



The Design Process

The design process can be short or long, but will always consist of a number of steps that are the same on every project. By splitting a project into these clearly defined steps, it becomes more structured and manageable. The steps allow clear focus on a specific task before moving to the next phase of the project. A typical design process is shown on the right.

Design brief

What is the purpose or aim of the project? Why is it required and who is it for?

Investigation

Research the background of the project. What might the requirements be? Are there competitors and what are they doing? The more information found out about the problem at this stage, the better, as it may make a big difference later in the project.

Specification

This is a complete list of all the requirements that the project must fulfil - no matter how small. This will allow you to focus on specifics at the design stage and to evaluate your design. Missing a key point from a specification can result in a product that does not fulfil its required task.

Design

Develop your ideas and produce a design that meets the requirements listed in the specification. At this stage it is often normal to prototype some of your ideas to see which work and which do not.

Build

Build your design based upon the design that you have developed.

Evaluate

Does the product meet all points listed in the specification? If not, return to the design stage and make the required changes. Does it then meet all of the requirements of the design brief? If not, return to the specification stage and make improvements to the specification that will allow the product to meet these requirements and repeat from this point. It is normal to have such iterations in design projects, though you normally aim to keep these to a minimum.

Improve

Do you feel the product could be improved in any way? These improvements can be added to the design.

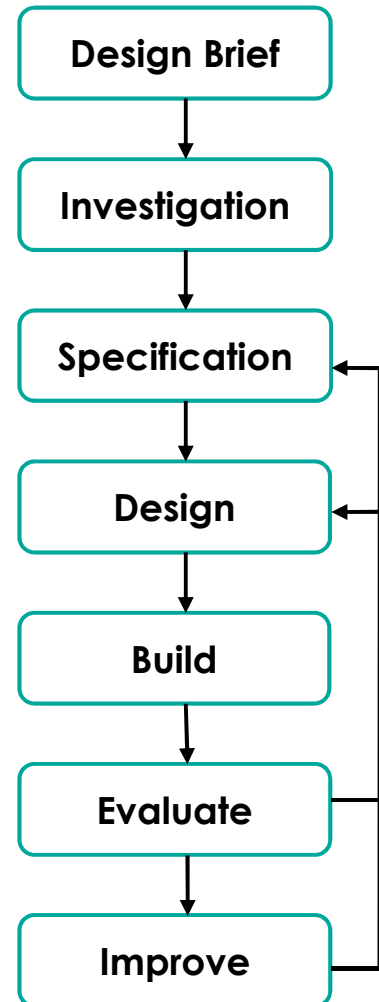

The Design Brief

A manufacturer has developed a simple circuit for producing a lamp that is powered by a 5V Micro USB power supply. The circuit has been developed to the point where they have a working Printed Circuit Board (PCB).

The manufacturer would like ideas for a product that can be created by designing an enclosure for this PCB. For example the lamp could be used for lighting a document making it easier to read or the lamp could also be used to create some form of mood lighting.

The manufacturer has asked you to do this for them. It is important that you make sure the final design meets all the requirements that you identify for such a product.

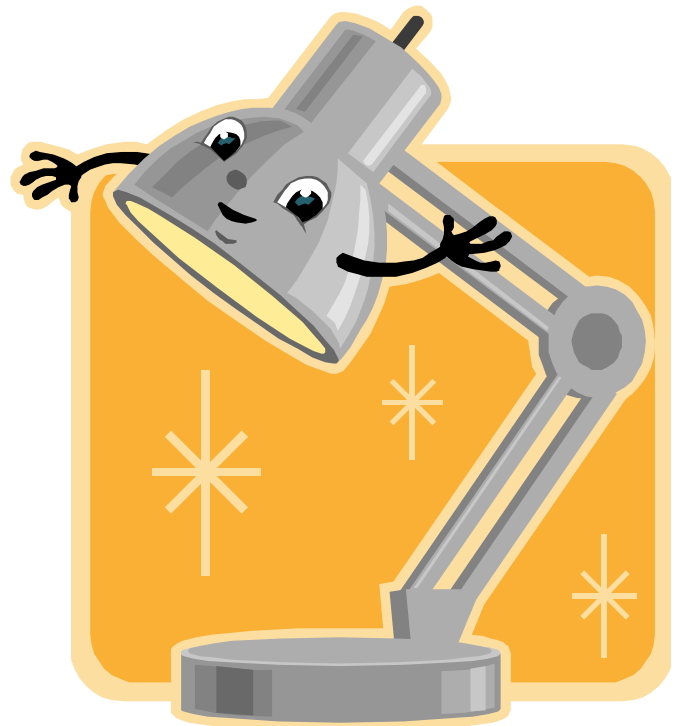

Complete Circuit

A fully built circuit is shown below.



Investigation / Research

Using a number of different search methods, find examples of similar products that are already on the market. Use additional pages if required.

Name.....

Class.....



Developing a Specification

Using your research into the target market for the product, identify the key requirements for the product and explain why each of these is important.

Name.....

Class.....

Requirement	Reason
Example: The enclosure should have a hole.	Example: So that the switch can be reached.



Design

Develop your ideas to produce a design that meets the requirements listed in the specification.

Name.....

Class.....



Design Review (group task)

Split into groups of three or four. Take it in turns to review each person's design against the requirements of their specification. Also look to see if you can spot any additional aspects of each design that may cause problems with the final product. This will allow you to ensure that you have a good design and catch any faults early in the design process. Note each point that is made and the reason behind it. Decide if you are going to accept or reject the comment made. Use these points to make improvements to your initial design.

Comment	Reason for comment	Accept or Reject



Soldering in Ten Steps

1. Start with the smallest components working up to the taller components, soldering any interconnecting wires last.
2. Place the component into the board, making sure that it goes in the right way around and the part sits flush against the board.
3. Bend the leads slightly to secure the part.
4. Make sure that the soldering iron has warmed up and if necessary, use the damp sponge to clean the tip.
5. Place the soldering iron on the pad.
6. Using your free hand, feed the end of the solder onto the pad (top picture).
7. Remove the solder, then the soldering iron.
8. Leave the joint to cool for a few seconds.
9. Using a pair of cutters, trim the excess component lead (middle picture).
10. If you make a mistake heat up the joint with the soldering iron, whilst the solder is molten, place the tip of your solder extractor by the solder and push the button (bottom picture).

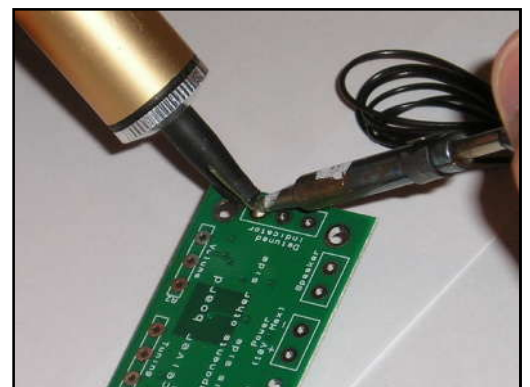
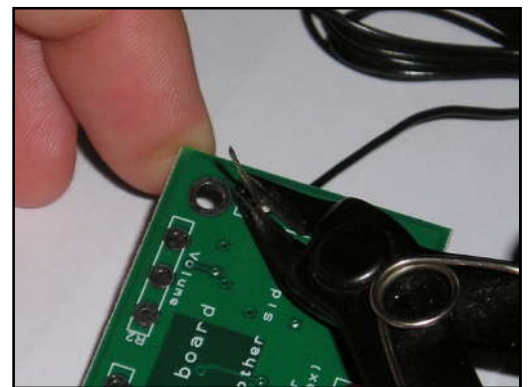
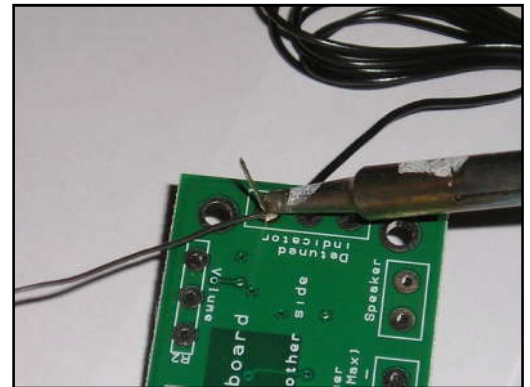

Solder joints

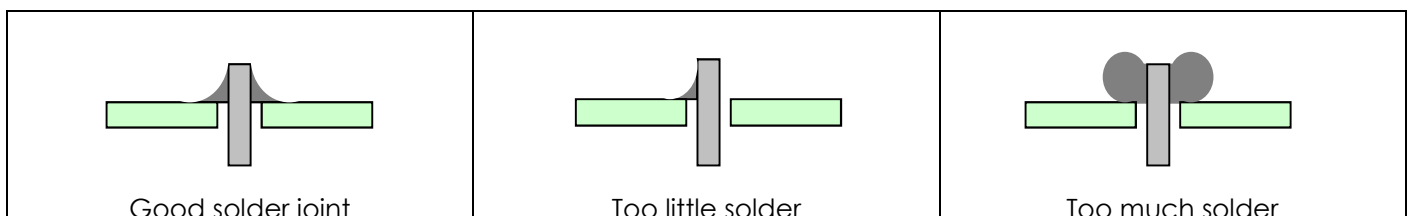

Resistor Values

A resistor is a device that opposes the flow of electrical current. The bigger the value of a resistor, the more it opposes the current flow. The value of a resistor is given in Ω (ohms) and is often referred to as its 'resistance'.

Identifying resistor values

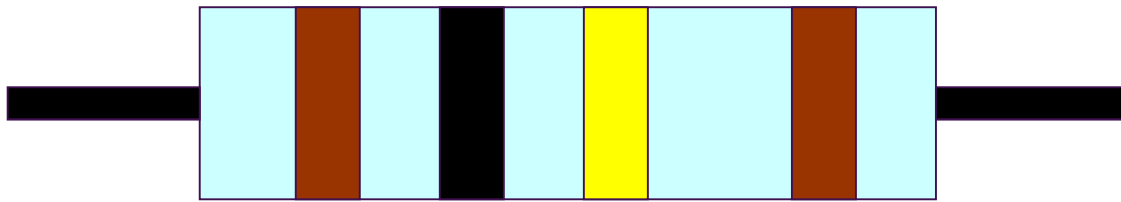

Band Colour	1st Band	2nd Band	Multiplier x	Tolerance
Silver			$\div 100$	10%
Gold			$\div 10$	5%
Black	0	0	1	
Brown	1	1	10	1%
Red	2	2	100	2%
Orange	3	3	1000	
Yellow	4	4	10,000	
Green	5	5	100,000	
Blue	6	6	1,000,000	
Violet	7	7		
Grey	8	8		
White	9	9		

Example: Band 1 = Red, Band 2 = Violet, Band 3 = Orange, Band 4 = Gold

The value of this resistor would be:

$$\begin{aligned}
 &2 \text{ (Red)} \ 7 \text{ (Violet)} \times 1,000 \text{ (Orange)} &&= 27 \times 1,000 \\
 &&&= 27,000 \text{ with a 5% tolerance (gold)} \\
 &&&= 27\text{K}\Omega
 \end{aligned}$$

Too many zeros?

Kilo ohms and mega ohms can be used:

$$1,000\Omega = 1\text{K}$$

$$1,000\text{K} = 1\text{M}$$

Resistor identification task

Calculate the resistor values given by the bands shown below. The tolerance band has been ignored.

1st Band	2nd Band	Multiplier x	Value
Brown	Black	Yellow	
Green	Blue	Brown	
Brown	Grey	Yellow	
Orange	White	Black	



Calculating resistor markings

Calculate what the colour bands would be for the following resistor values.

Value	1st Band	2nd Band	Multiplier x
180 Ω			
3,900 Ω			
47,000 (47K) Ω			
1,000,000 (1M) Ω			

What does tolerance mean?

Resistors always have a tolerance but what does this mean? It refers to the accuracy to which it has been manufactured. For example if you were to measure the resistance of a gold tolerance resistor you can guarantee that the value measured will be within 5% of its stated value. Tolerances are important if the accuracy of a resistors value is critical to a design's performance.

Preferred values

There are a number of different ranges of values for resistors. Two of the most popular are the E12 and E24. They take into account the manufacturing tolerance and are chosen such that there is a minimum overlap between the upper possible value of the first value in the series and the lowest possible value of the next. Hence there are fewer values in the 10% tolerance range.

E-12 resistance tolerance ($\pm 10\%$)											
10	12	15	18	22	27	33	39	47	56	68	82

E-24 resistance tolerance ($\pm 5\%$)											
10	11	12	13	15	16	18	20	22	24	27	30
33	36	39	43	47	51	56	62	68	75	82	91



LEDs & Current Limit Resistors

Before we look at LEDs, we first need to start with diodes. Diodes are used to control the direction of flow of electricity. In one direction they allow the current to flow through the diode, in the other direction the current is blocked.

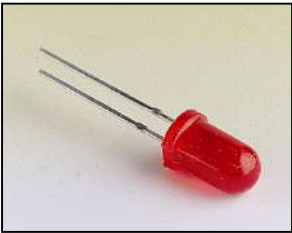

An LED is a special diode. LED stands for Light Emitting Diode. LEDs are like normal diodes, in that they only allow current to flow in one direction, however when the current is flowing the LED lights.

The symbol for an LED is the same as the diode but with the addition of two arrows to show that there is light coming from the diode. As the LED only allows current to flow in one direction, it's important that we can work out which way the electricity will flow. This is indicated by a flat edge on the LED.

For an LED to light properly, the amount of current that flows through it needs to be controlled. To do this we use a current limit resistor. If we didn't use a current limit resistor the LED would be very bright for a short amount of time, before being permanently destroyed.

To work out the best resistor value we need to use Ohms Law. This connects the voltage across a device and the current flowing through it to its resistance.

Ohms Law tells us that the flow of current (I) in a circuit is given by the voltage (V) across the circuit divided by the resistance (R) of the circuit.

$$I = \frac{V}{R}$$

Like diodes, LEDs drop some voltage across them: typically 1.8 volts for a standard LED. However the high brightness LED used in the 'white light' version of the lamp drops 3.5 volts.

The USB lamp runs off the 5V supply provided by the USB connection so there must be a total of 5 volts dropped across the LED (V_{LED}) and the resistor (V_R). As the LED manufacturer's datasheet tells us that there is 3.5 volts dropped across the LED, there must be 1.5 volts dropped across the resistor. ($V_{LED} + V_R = 3.5 + 1.5 = 5V$).

LEDs normally need about 10mA to operate at a good brightness. For this high power LED we need 150mA. Since we know that the voltage across the current limit resistor is 1.5 volts and we know that the current flowing through it is 0.15 Amps, the resistor can be calculated.

Using Ohms Law in a slightly rearranged format:

$$R = \frac{V}{I} = \frac{1.5}{0.15} = 10\Omega$$

Hence we need a 10Ω current limit resistor.

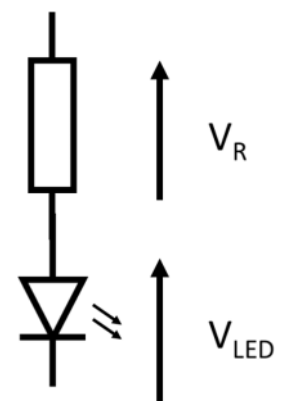

LEDs Continued

The Colour Changing LEDs used in the 'colour' version of the lamp has the current limit resistor built into the LED itself. Therefore no current limit resistor is required. Because of this, a 'zero Ω ' resistor is used to connect the voltage supply of 5V directly to the Colour Changing LED.

Packages

LEDs are available in many shapes and sizes. The 5mm round LED is the most common. The colour of the plastic lens is often the same as the actual colour of light emitted – but not always with high brightness LEDs.

Advantages of using LEDs over bulbs

Some of the advantages of using an LED over a traditional bulb are:

Power efficiency	LEDs use less power to produce the same amount of light, which means that they are more efficient. This makes them ideal for battery power applications.
Long life	LEDs have a very long life when compared to normal light bulbs. They also fail by gradually dimming over time instead of a sharp burn out.
Low temperature	Due to the higher efficiency of LEDs, they can run much cooler than a bulb.
Hard to break	LEDs are much more resistant to mechanical shock, making them more difficult to break than a bulb.
Small	LEDs can be made very small. This allows them to be used in many applications, which would not be possible with a bulb.
Fast turn on	LEDs can light up faster than normal light bulbs, making them ideal for use in car brake lights.

Disadvantages of using LEDs

Some of the disadvantages of using an LED over a traditional bulb are:

Cost	LEDs currently cost more for the same light output than traditional bulbs. However, this needs to be balanced against the lower running cost of LEDs due to their greater efficiency.
Drive circuit	To work in the desired manner, an LED must be supplied with the correct current. This could take the form of a series resistor or a regulated power supply.
Directional	LEDs normally produce a light that is focused in one direction, which is not ideal for some applications.

Typical LED applications

Some applications that use LEDs are:

- Bicycle lights
- Car lights (brake and headlights)
- Traffic lights
- Indicator lights on consumer electronics
- Torches
- Backlights on flat screen TVs and displays
- Road signs
- Information displays
- Household lights
- Clocks



Instruction Manual

Your lamp is going to be supplied with some instructions. Identify four points that must be included in the instructions and give a reason why.

Point to include:

Reason:

Point to include:

Reason:

Point to include:

Reason:

Point to include:

Reason:



Evaluation

It is always important to evaluate your design once it is complete. This will ensure that it has met all of the requirements defined in the specification. In turn, this should ensure that the design fulfils the design brief.

Check that your design meets all of the points listed in your specification.

Show your product to another person (in real life this person should be the kind of person at which the product is aimed). Get them to identify aspects of the design, which parts they like and aspects that they feel could be improved.

Good aspects of the design	Areas that could be improved

Improvements

Every product on the market is constantly subject to redesign and improvement. What aspects of your design do you feel you could improve? List the aspects that could be improved and where possible, draw a sketch showing the changes that you would make.



Packaging Design

If your product was to be sold in a high street electrical retailer, what requirements would the packaging have? List these giving the reason for the requirement.

Requirement	Reason

Develop a packaging design for your product that meets these requirements. Use additional pages if required.



DESIGN A STYLISH LAMP WITH THIS

Micro USB Lamp Kit

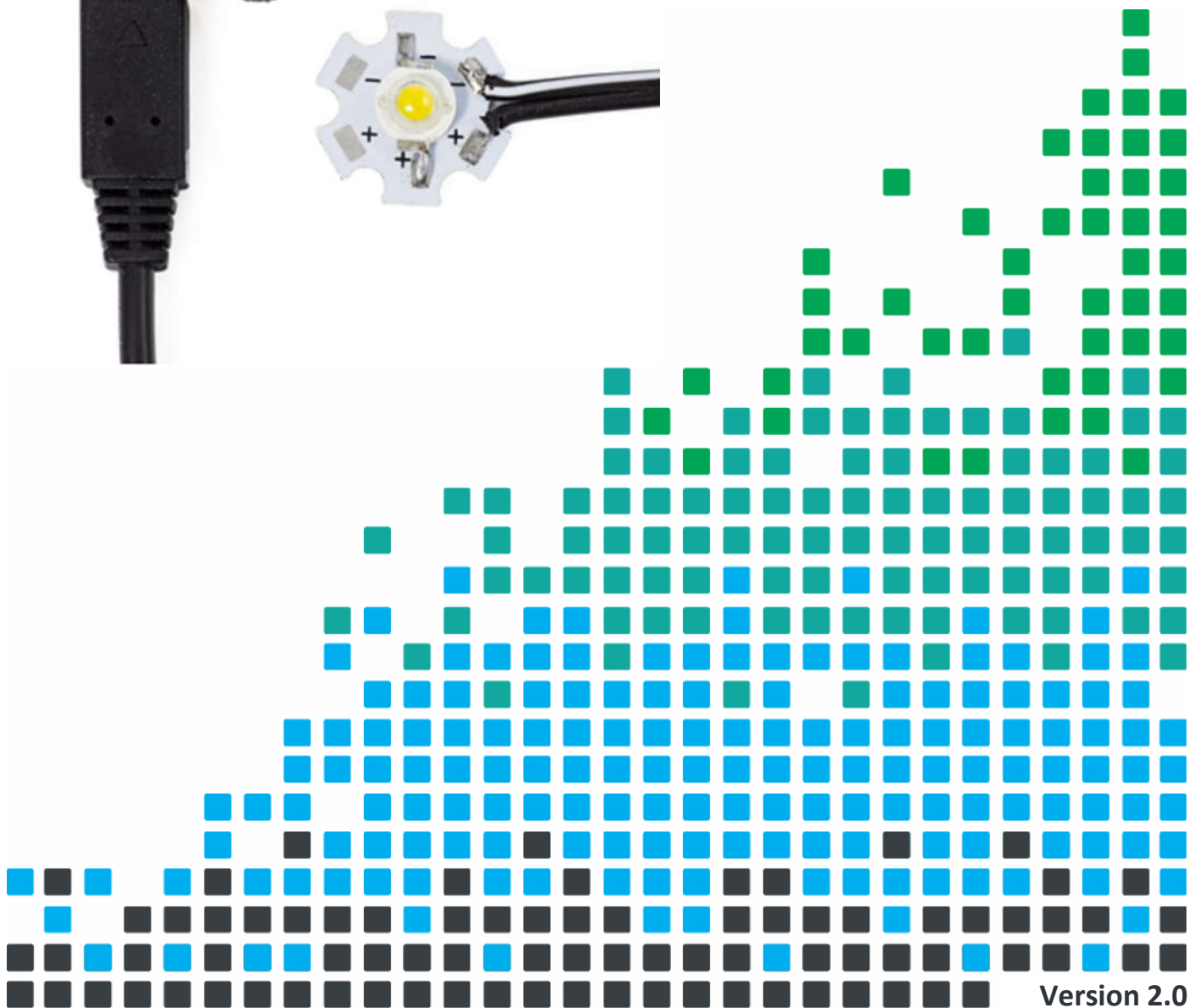

Build Instructions

Before you start, take a look at the Printed Circuit Board (PCB). The components go in the side with the writing on and the solder goes on the side with the tracks and silver pads.

1 PLACE RESISTORS

Start with the resistor R1. The text on the PCB shows where R1 should go. It doesn't matter which way around the resistor goes into the board.

PCB Ref	Value	Colour Bands
R1	10Ω	Brown, black, black



2 SOLDER THE SWITCH

Solder the PCB Mount Right Angled On / Off Slide Switch into SW1. The row of three pins that exit the back of the switch must be soldered but it will not matter too much if you can't solder the other two pins.



3 SOLDER THE WIRES TO THE LED

Solder the wire with the white stripe to one of the negative pads on the LED, it doesn't matter which one. The negative pads are indicated with a '-' symbol. Solder the plain black wire to one of the positive pads, the positive pads are indicated with a '+' symbol.

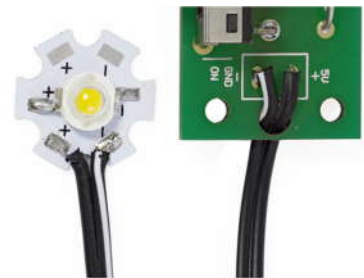

4 PLUG IN THE POWER

Plug a 5V Micro USB power supply (such as a mobile phone charger) into the connector then slide the switch to the on position, labelled on the PCB.

Note: The LED and resistor will get quite warm to the touch, so avoid handling if it is on or has recently been on for a long time.



Checking Your Micro USB Lamp PCB

- Is the positive '+' pad on the LED wired to the terminal labelled '5V' on the PCB?
- Is the negative '-' pad on the LED wired to the terminal labelled 'GND' on the PCB?
- Have you soldered the resistor into the position marked R1 on the PCB?

How the Micro USB Lamp Works

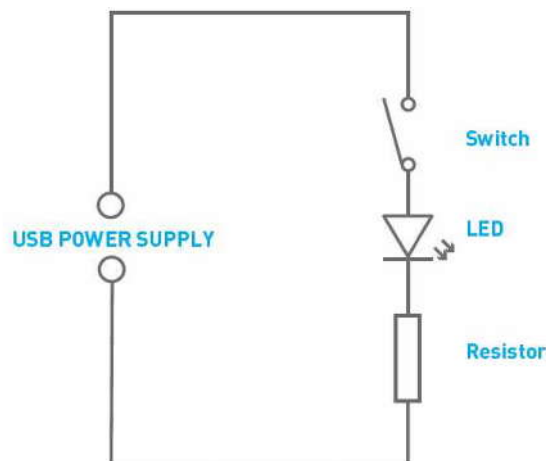

The circuit diagram for the USB lamp is shown above. It is a very simple circuit. The 5V that powers the circuit is supplied from the micro USB connector.

LEDs can be damaged if the current through them is not limited.

A 10 Ω resistor has been selected to limit the current through the white LED. This allows 150mA to flow through the LED so that it is at a good brightness.

Finally, the on / off switch allows the circuit to be opened and closed: open the switch to turn the LED off and close the switch to turn the LED on.



Designing the Enclosure

When you design the enclosure, you will need to consider:

- The size of the PCB and LED (below).
- Where the on / off switch is mounted.
- There are four 3.3mm holes in the corners of the PCB to secure the PCB in the enclosure.

These technical drawings of the built Micro USB Lamp PCB and the LED should help you to design your enclosure. All dimensions are in mm

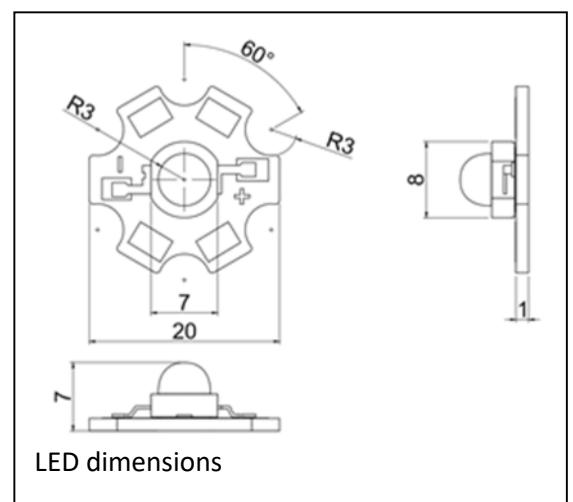
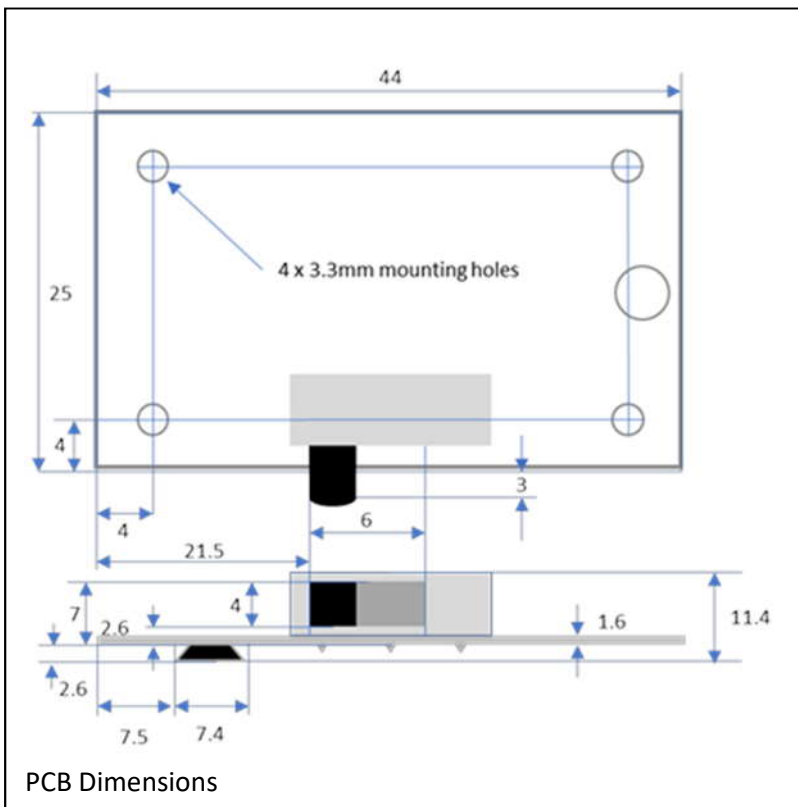

If mounting the LED with metal fixings take care to ensure that the PCB pads are not shorted out.

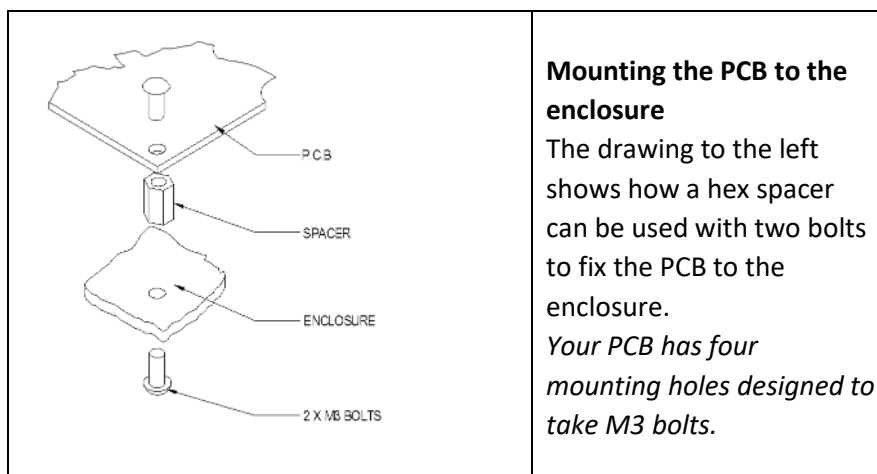

Online Information

Two sets of information can be downloaded from the product page where the kit can also be reordered from. The 'Essential Information' contains all of the information that you need to get started with the kit and the 'Teaching Resources' contains more information on soldering, components used in the kit, educational schemes of work and so on and also includes the essentials. Download from:

www.kitronik.co.uk/2161



This kit is designed and manufactured in the UK by Kitronik

Telephone: +44 (0) 845 8380781

Sales email: sales@kitronik.co.uk

Tech support email: support@kitronik.co.uk

Web: www.kitronik.co.uk



www.kitronik.co.uk/twitter



www.kitronik.co.uk/facebook



www.kitronik.co.uk/youtube



www.kitronik.co.uk/google

Every effort has been made to ensure that these notes are correct, however Kitronik accept no responsibility for issues arising from errors / omissions in the notes.

© Kitronik Ltd - Any unauthorised copying / duplication of this booklet or part thereof for purposes except for use with Kitronik project kits is not allowed without Kitronik's prior consent.

