

MJL21195 (PNP), MJL21196 (NPN)

Silicon Power Transistors

The MJL21195 and MJL21196 utilize Perforated Emitter technology and are specifically designed for high power audio output, disk head positioners and linear applications.

Features

- Total Harmonic Distortion Characterized
- High DC Current Gain
- Excellent Gain Linearity
- High SOA
- Epoxy Meets UL 94, V-0 @ 0.125 in
- These Devices are Pb-Free and are RoHS Compliant*

MAXIMUM RATINGS

Rating	Symbol	Value	Unit
Collector-Emitter Voltage	V_{CEO}	250	Vdc
Collector-Base Voltage	V_{CBO}	400	Vdc
Emitter-Base Voltage	V_{EBO}	5	Vdc
Collector-Emitter Voltage – 1.5 V	V_{CEX}	400	Vdc
Collector Current – Continuous	I_C	16	Adc
Collector Current – Peak (Note 1)	I_{CM}	30	Adc
Base Current – Continuous	I_B	5	Adc
Total Power Dissipation @ $T_C = 25^\circ\text{C}$ Derate Above 25°C	P_D	200 1.43	W W/ $^\circ\text{C}$
Operating and Storage Junction Temperature Range	T_J, T_{stg}	-65 to +150	$^\circ\text{C}$
ESD – Human Body Model	HBM	3B	V
ESD – Machine Model	MM	C	V

Stresses exceeding Maximum Ratings may damage the device. Maximum Ratings are stress ratings only. Functional operation above the Recommended Operating Conditions is not implied. Extended exposure to stresses above the Recommended Operating Conditions may affect device reliability.

1. Pulse Test: Pulse Width = 5.0 μs , Duty Cycle $\leq 10\%$.

THERMAL CHARACTERISTICS

Characteristic	Symbol	Max	Unit
Thermal Resistance, Junction-to-Case	$R_{\theta JC}$	0.7	$^\circ\text{C}/\text{W}$



ON Semiconductor®

<http://onsemi.com>

16 A COMPLEMENTARY SILICON POWER TRANSISTORS 250 V, 200 W

COMPLEMENTARY

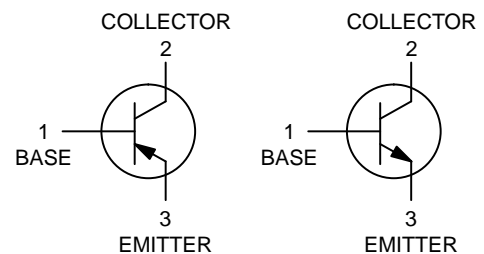

MARKING DIAGRAM

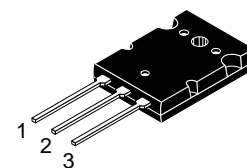

**TO-264
CASE 340G
STYLE 2**

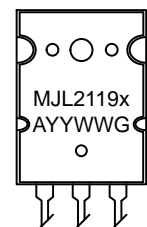

x = 5 or 6
A = Assembly Location
YY = Year
WW = Work Week
G = Pb-Free Package

ORDERING INFORMATION

Device	Package	Shipping
MJL21195G	TO-264 (Pb-Free)	25 Units / Rail
MJL21196G	TO-264 (Pb-Free)	25 Units / Rail

*For additional information on our Pb-Free strategy and soldering details, please download the ON Semiconductor Soldering and Mounting Techniques Reference Manual, SOLDERRM/D.

MJL21195 (PNP), MJL21196 (NPN)

ELECTRICAL CHARACTERISTICS ($T_C = 25^\circ\text{C}$ unless otherwise noted)

Characteristic	Symbol	Min	Typical	Max	Unit
----------------	--------	-----	---------	-----	------

OFF CHARACTERISTICS (Note 2)

Collector-Emitter Sustaining Voltage ($I_C = 100\text{ mA}$, $I_B = 0$)	$V_{CEO(sus)}$	250	–	–	Vdc
Collector Cutoff Current ($V_{CE} = 200\text{ Vdc}$, $I_B = 0$)	I_{CEO}	–	–	100	μAdc

OFF CHARACTERISTICS (Note 3)

Emitter Cutoff Current ($V_{CE} = 5\text{ Vdc}$, $I_C = 0$)	I_{EBO}	–	–	100	μAdc
Collector Cutoff Current ($V_{CE} = 250\text{ Vdc}$, $V_{BE(off)} = 1.5\text{ Vdc}$)	I_{CEX}	–	–	100	μAdc

SECOND BREAKDOWN (Note 3)

Second Breakdown Collector Current with Base Forward Biased ($V_{CE} = 50\text{ Vdc}$, $t = 1\text{ s}$ (Nonrepetitive)) ($V_{CE} = 80\text{ Vdc}$, $t = 1\text{ s}$ (Nonrepetitive))	$I_{S/b}$	4.0 2.25	– –	– –	Adc
---	-----------	-------------	--------	--------	-----

ON CHARACTERISTICS (Note 3)

DC Current Gain ($I_C = 8\text{ Adc}$, $V_{CE} = 5\text{ Vdc}$) ($I_C = 16\text{ Adc}$, $I_B = 5\text{ Adc}$)	h_{FE}	25 8.0	– –	100 –	–
Base-Emitter On Voltage ($I_C = 8\text{ Adc}$, $V_{CE} = 5\text{ Vdc}$)	$V_{BE(on)}$	–	–	2.2	Vdc
Collector-Emitter Saturation Voltage ($I_C = 8\text{ Adc}$, $I_B = 0.8\text{ Adc}$) ($I_C = 16\text{ Adc}$, $I_B = 3.2\text{ Adc}$)	$V_{CE(sat)}$	– –	– –	1.4 4	Vdc

DYNAMIC CHARACTERISTICS (Note 3)

Total Harmonic Distortion at the Output ($V_{RMS} = 28.3\text{ V}$, $f = 1\text{ kHz}$, $P_{LOAD} = 100\text{ W}_{RMS}$) h_{FE} unmatched (Matched pair $h_{FE} = 50 @ 5\text{ A}/5\text{ V}$) h_{FE} matched	T_{HD}	– –	0.8 0.08	– –	%
Current Gain Bandwidth Product ($I_C = 1\text{ Adc}$, $V_{CE} = 10\text{ Vdc}$, $f_{test} = 1\text{ MHz}$)	f_T	4	–	–	MHz
Output Capacitance ($V_{CB} = 10\text{ Vdc}$, $I_E = 0$, $f_{test} = 1\text{ MHz}$)	C_{ob}	–	–	500	pF

2. Pulse Test: Pulse Width = $5.0\ \mu\text{s}$, Duty Cycle $\leq 10\%$.
3. Pulse Test: Pulse Width = $300\ \mu\text{s}$, Duty Cycle $\leq 2\%$.

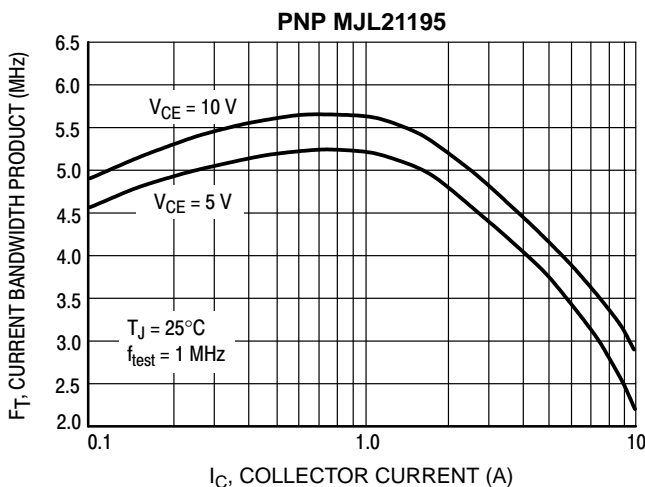

Figure 1. Typical Current Gain Bandwidth Product

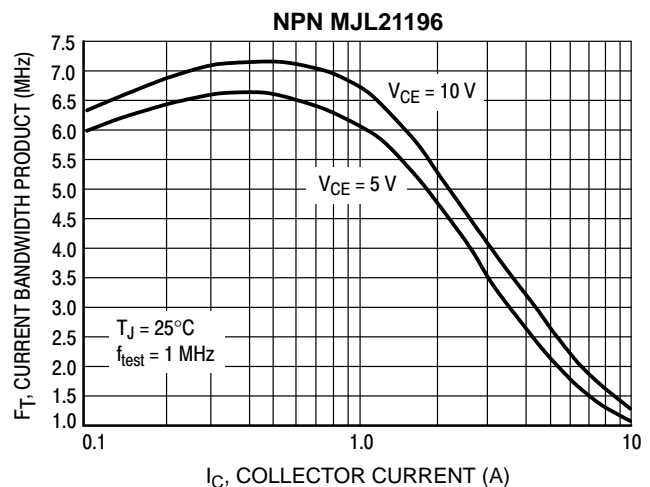

Figure 2. Typical Current Gain Bandwidth Product

MJL21195 (PNP), MJL21196 (NPN)

TYPICAL CHARACTERISTICS

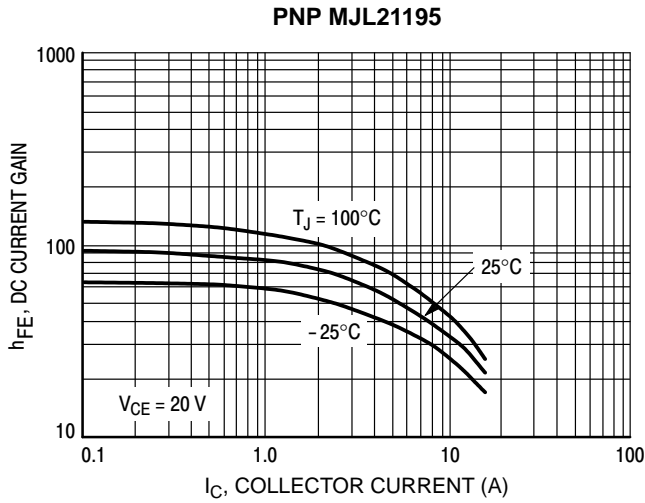

Figure 3. DC Current Gain, $V_{CE} = 20\text{ V}$

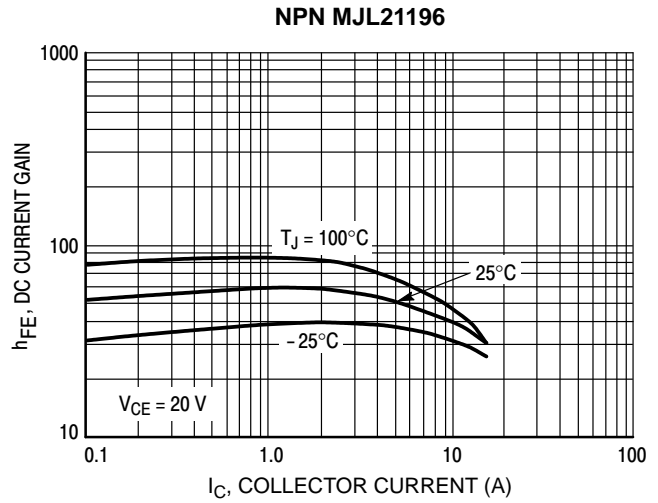

Figure 4. DC Current Gain, $V_{CE} = 20\text{ V}$

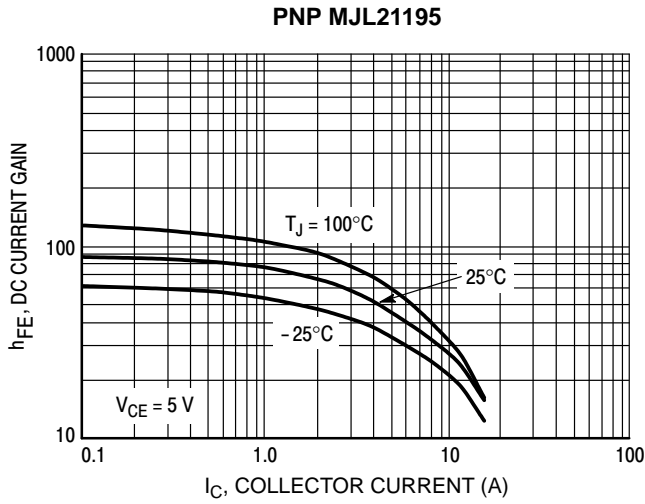

Figure 5. DC Current Gain, $V_{CE} = 5\text{ V}$

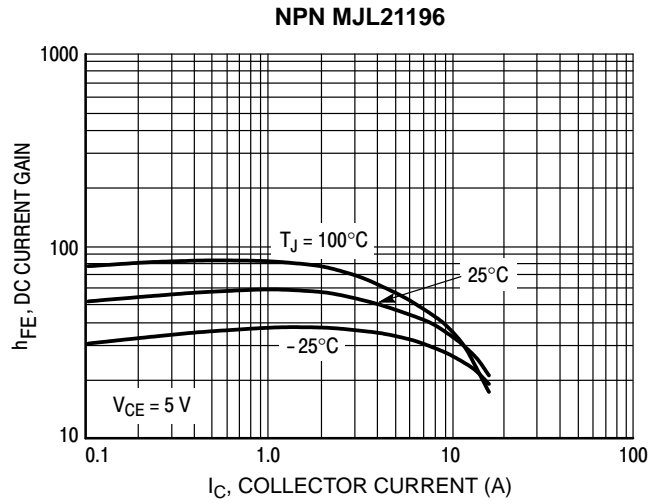

Figure 6. DC Current Gain, $V_{CE} = 5\text{ V}$

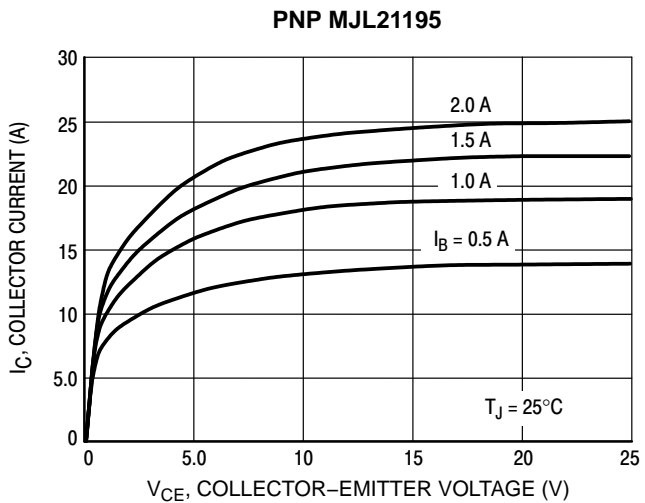

Figure 7. Typical Output Characteristics

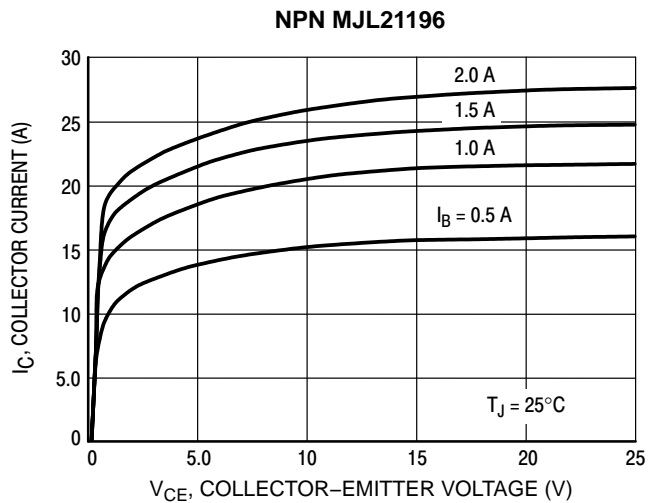

Figure 8. Typical Output Characteristics

MJL21195 (PNP), MJL21196 (NPN)

TYPICAL CHARACTERISTICS

PNP MJL21195

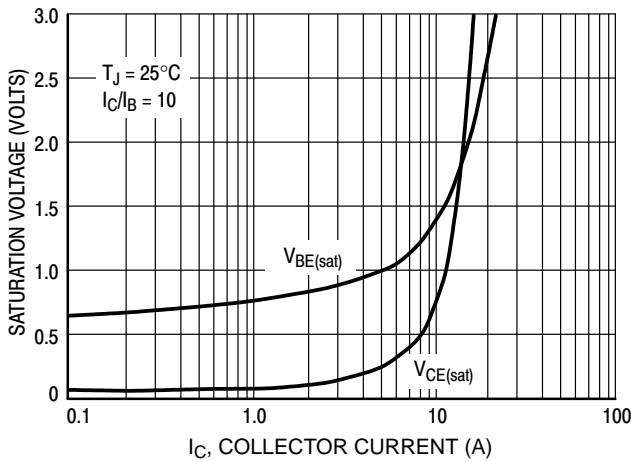

Figure 9. Typical Saturation Voltages

NPN MJL21196

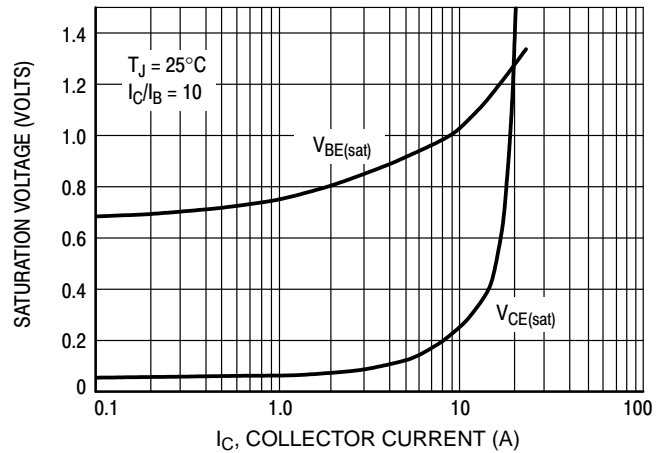

Figure 10. Typical Saturation Voltages

PNP MJL21195

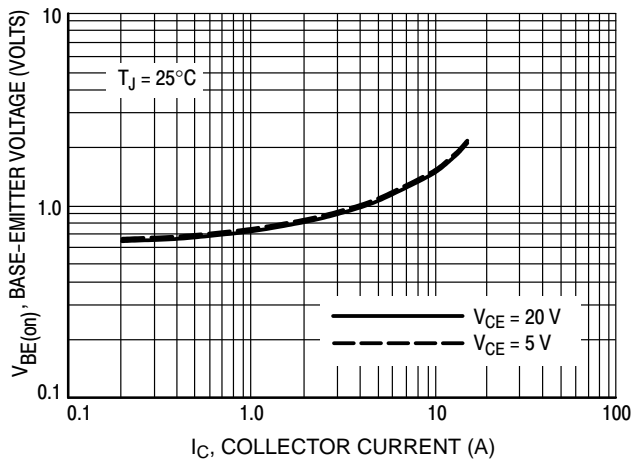

Figure 11. Typical Base-Emitter Voltage

NPN MJL21196

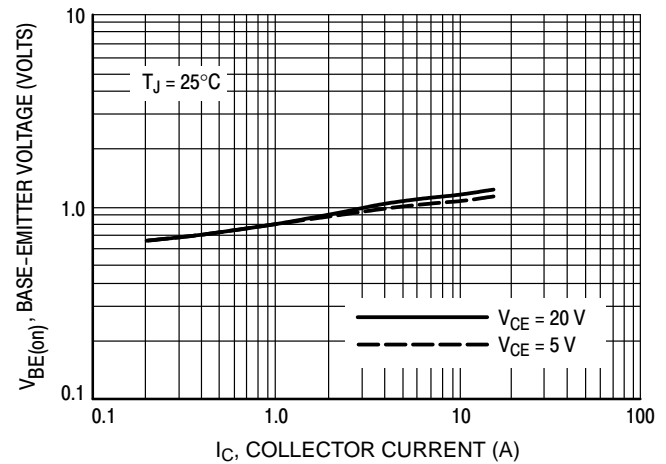

Figure 12. Typical Base-Emitter Voltage

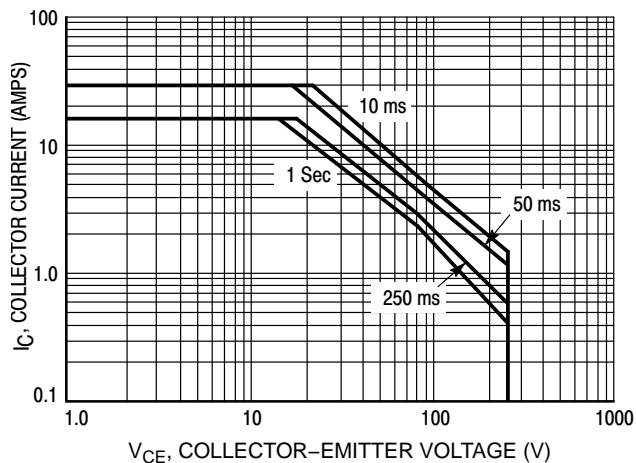

Figure 13. Active Region Safe Operating Area

There are two limitations on the power handling ability of a transistor; average junction temperature and secondary breakdown. Safe operating area curves indicate $I_C - V_{CE}$ limits of the transistor that must be observed for reliable operation; i.e., the transistor must not be subjected to greater dissipation than the curves indicate.

The data of Figure 13 is based on $T_{J(pk)} = 150^\circ\text{C}$; T_C is variable depending on conditions. At high case temperatures, thermal limitations will reduce the power than can be handled to values less than the limitations imposed by second breakdown.

MJL21195 (PNP), MJL21196 (NPN)

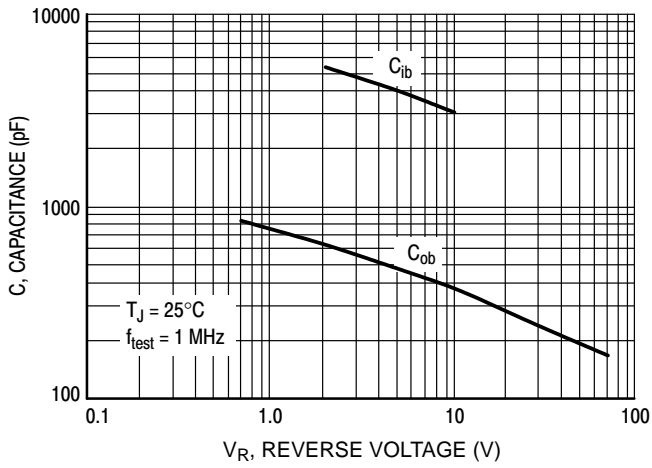

Figure 14. MJL21195 Typical Capacitance

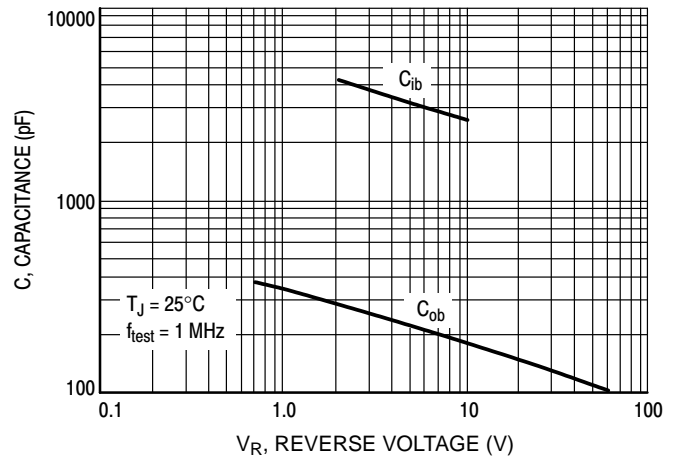

Figure 15. MJL21196 Typical Capacitance

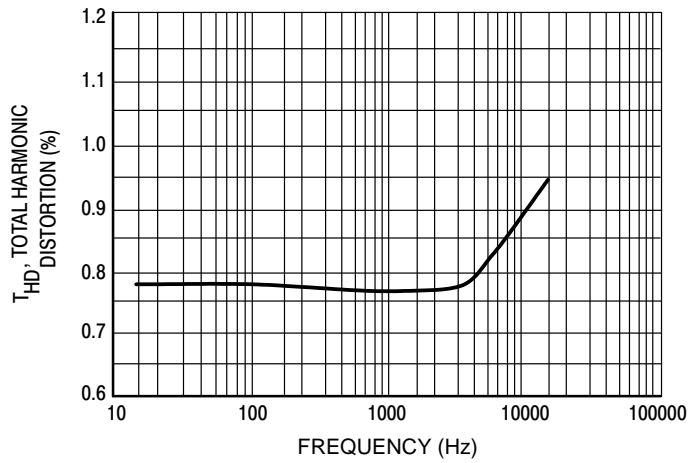

Figure 16. Typical Total Harmonic Distortion

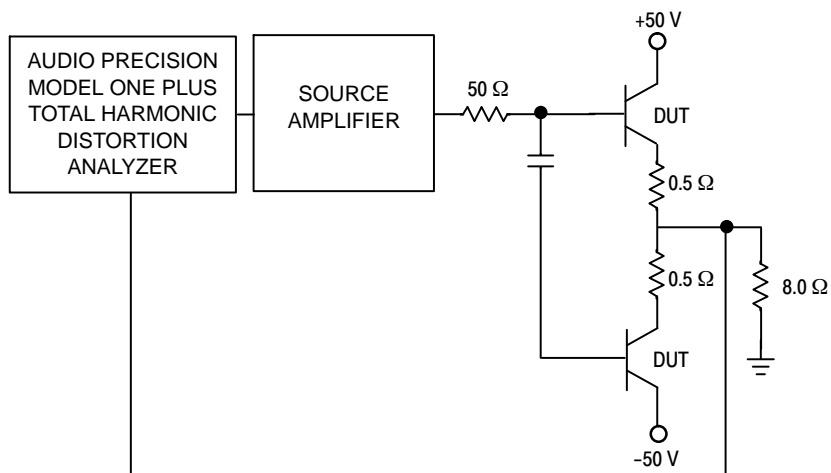
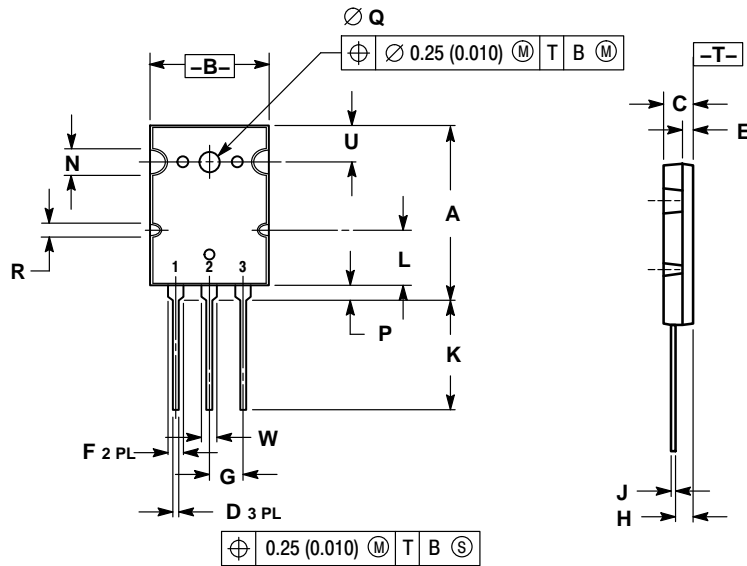

Figure 17. Total Harmonic Distortion Test Circuit

MJL21195 (PNP), MJL21196 (NPN)

PACKAGE DIMENSIONS

TO-3BPL (TO-264)
CASE 340G-02
ISSUE J



- NOTES:
1. DIMENSIONING AND TOLERANCING PER ANSI Y14.5M, 1982.
 2. CONTROLLING DIMENSION: MILLIMETER.

DIM	MILLIMETERS		INCHES	
	MIN	MAX	MIN	MAX
A	28.0	29.0	1.102	1.142
B	19.3	20.3	0.760	0.800
C	4.7	5.3	0.185	0.209
D	0.93	1.48	0.037	0.058
E	1.9	2.1	0.075	0.083
F	2.2	2.4	0.087	0.102
G	5.45 BSC		0.215 BSC	
H	2.6	3.0	0.102	0.118
J	0.43	0.78	0.017	0.031
K	17.6	18.8	0.693	0.740
L	11.2 REF		0.411 REF	
N	4.35 REF		0.172 REF	
P	2.2	2.6	0.087	0.102
Q	3.1	3.5	0.122	0.137
R	2.25 REF		0.089 REF	
U	6.3 REF		0.248 REF	
W	2.8	3.2	0.110	0.125

- STYLE 2:
1. BASE
 2. COLLECTOR
 3. EMITTER

ON Semiconductor and are registered trademarks of Semiconductor Components Industries, LLC (SCILLC). SCILLC owns the rights to a number of patents, trademarks, copyrights, trade secrets, and other intellectual property. A listing of SCILLC's product/patent coverage may be accessed at www.onsemi.com/site/pdf/Patent-Marking.pdf. SCILLC reserves the right to make changes without further notice to any products herein. SCILLC makes no warranty, representation or guarantee regarding the suitability of its products for any particular purpose, nor does SCILLC assume any liability arising out of the application or use of any product or circuit, and specifically disclaims any and all liability, including without limitation special, consequential or incidental damages. "Typical" parameters which may be provided in SCILLC data sheets and/or specifications can and do vary in different applications and actual performance may vary over time. All operating parameters, including "Typicals" must be validated for each customer application by customer's technical experts. SCILLC does not convey any license under its patent rights nor the rights of others. SCILLC products are not designed, intended, or authorized for use as components in systems intended for surgical implant into the body, or other applications intended to support or sustain life, or for any other application in which the failure of the SCILLC product could create a situation where personal injury or death may occur. Should Buyer purchase or use SCILLC products for any such unintended or unauthorized application, Buyer shall indemnify and hold SCILLC and its officers, employees, subsidiaries, affiliates, and distributors harmless against all claims, costs, damages, and expenses, and reasonable attorney fees arising out of, directly or indirectly, any claim of personal injury or death associated with such unintended or unauthorized use, even if such claim alleges that SCILLC was negligent regarding the design or manufacture of the part. SCILLC is an Equal Opportunity/Affirmative Action Employer. This literature is subject to all applicable copyright laws and is not for resale in any manner.

PUBLICATION ORDERING INFORMATION

LITERATURE FULFILLMENT:

Literature Distribution Center for ON Semiconductor
P.O. Box 5163, Denver, Colorado 80217 USA
Phone: 303-675-2175 or 800-344-3860 Toll Free USA/Canada
Fax: 303-675-2176 or 800-344-3867 Toll Free USA/Canada
Email: orderlit@onsemi.com

N. American Technical Support: 800-282-9855 Toll Free
USA/Canada
Europe, Middle East and Africa Technical Support:
Phone: 421 33 790 2910
Japan Customer Focus Center
Phone: 81-3-5817-1050

ON Semiconductor Website: www.onsemi.com

Order Literature: <http://www.onsemi.com/orderlit>

For additional information, please contact your local Sales Representative