

Manganese Lithium Coin Batteries (ML series): Individual Specifications

ML616S

■ Dimensions(mm)

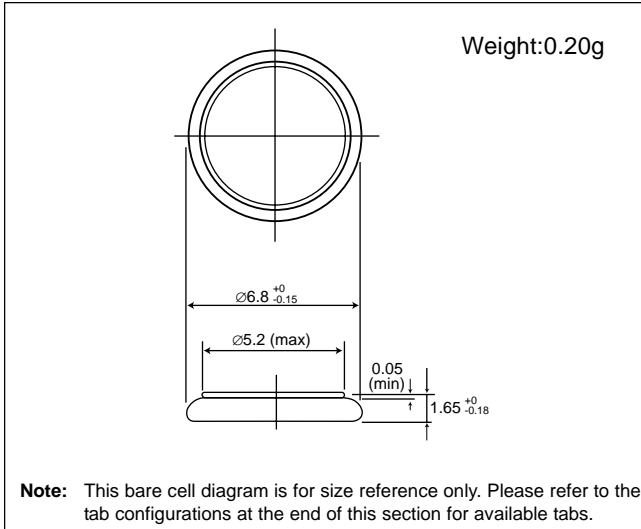

■ Specification

Nominal voltage (V)	3
Nominal capacity (mAh)	2.9
Continuous standard load (mA)	0.01
Operating temperature (C)	-20 ~ +60

■ Discharge characteristics

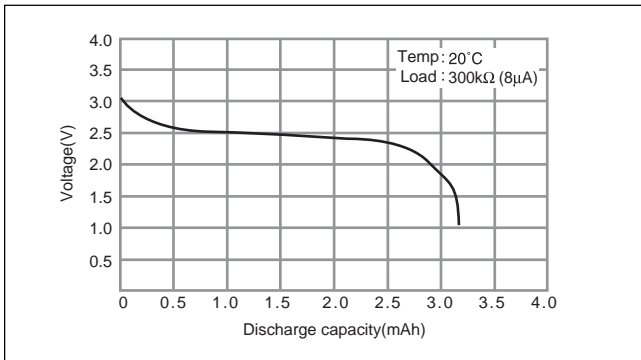

■ Consumption current vs. Duration time

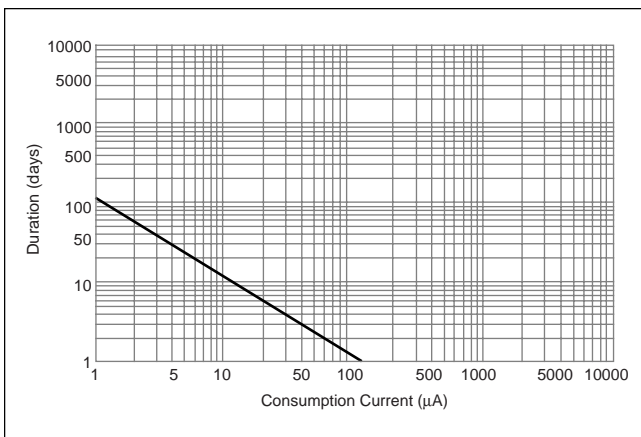

ML621S

■ Dimensions(mm)

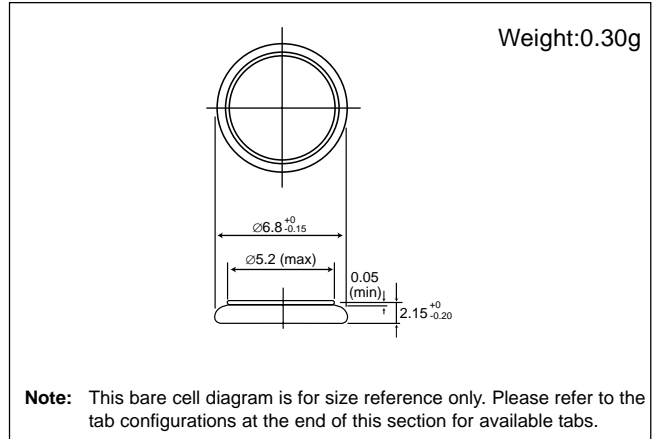

■ Specification

Nominal voltage (V)	3
Nominal capacity (mAh)	5
Continuous standard load (mA)	0.01
Operating temperature (C)	-20 ~ +60

■ Discharge characteristics

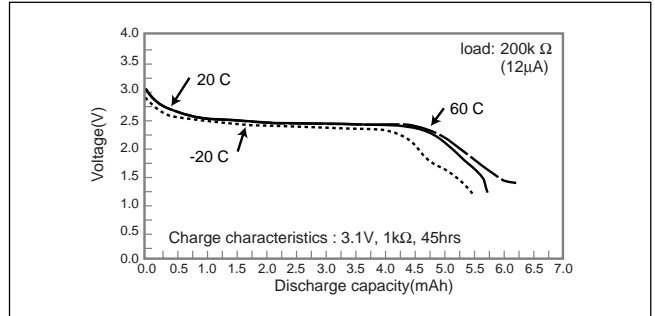

■ Charge characteristics

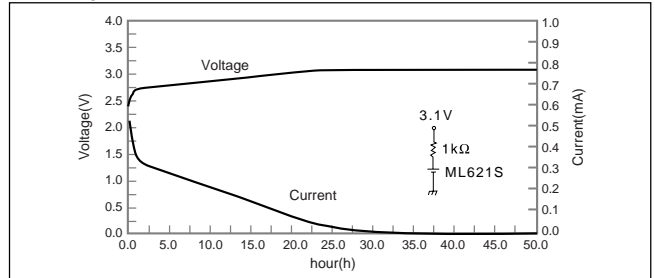

■ Consumption current vs. Duration time

