



## STM8L1528-EVAL demonstration firmware

---

### **1 Introduction**

This document describes the demonstration firmware running on the STM8L1528-EVAL evaluation board. You can use it to evaluate the capabilities of the STM8L151x, STM8L152x and STM8L162x microcontrollers and their on-board peripherals.

The evaluation board is delivered with the demonstration firmware stored in the Flash program memory of the microcontroller.

The firmware is based on the STM8L15x firmware library, and provides an example of how to use this library. It is divided into various smaller demonstration applications (demos).

In case the STM8L1528-EVAL evaluation board is not factory-programmed or the demonstration application has been erased, you can reprogram the demonstration firmware into the STM8L15x Flash memory by following the instructions provided in [Section 4](#).

For more information about the evaluation board itself, please read the evaluation board user manual.

# Contents

<b>1</b>	<b>Introduction</b>	<b>1</b>
<b>2</b>	<b>User interface</b>	<b>3</b>
2.1	Menu structure	3
2.2	Documentation conventions	3
2.3	Navigating menus and submenus	4
2.4	STM8L1528-EVAL board jumper configuration	4
<b>3</b>	<b>Demonstration applications</b>	<b>5</b>
3.1	Menu overview	5
3.2	Welcome screen and main menu	6
3.3	Help mode	6
3.4	Calendar demo	7
3.4.1	Setting the time	7
3.4.2	Setting the date	8
3.4.3	Setting the alarm	9
3.5	Thermometer demo	10
3.6	I <sub>DD</sub> measurement demo	11
3.7	Low power demo	12
3.7.1	Run mode	12
3.7.2	Wait for interrupt mode	12
3.7.3	Wait for event mode	13
3.7.4	Active-Halt mode	14
3.7.5	Halt mode	16
3.8	Audio demo	17
3.8.1	Voice recorder demo	17
3.8.2	Voice player demo	18
3.8.3	Wave player demo	19
3.9	About menu	20
<b>4</b>	<b>Upgrading the demonstration firmware</b>	<b>21</b>
4.1	Programming the media files	21
4.2	Programming the demonstration	21
<b>5</b>	<b>STM8L15x peripherals used</b>	<b>22</b>
<b>6</b>	<b>Revision history</b>	<b>22</b>

## 2 User interface

### 2.1 Menu structure

The demonstration firmware user interface is based on a circular navigation menu, with submenus, item selection and back capability.

*Figure 1* shows the menu system of the demonstration. The top row of items represents the main menu.

**Figure 1. Menu structure and navigation**

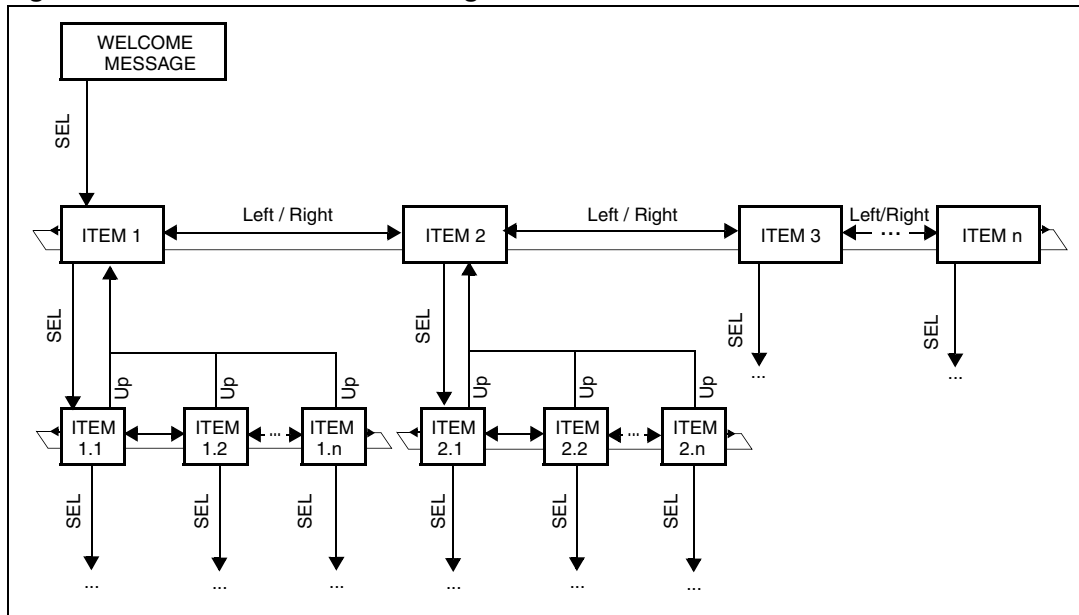

### 2.2 Documentation conventions

In this document, the keywords in bold indicate user actions on the joystick (5-way switch) and the RV3 potentiometer.

The present document follows the conventions shown in *Table 1*.

**Table 1. Documentation conventions**

<b>Keyword</b>	<b>User action</b>
<b>LEFT</b>	Press joystick to the left
<b>RIGHT</b>	Press joystick to the right
<b>UP</b>	Press joystick up
<b>DOWN</b>	Press joystick down
<b>SEL</b>	Press joystick center
<b>RV3</b>	Rotate RV3 potentiometer

## 2.3 Navigating menus and submenus

To navigate the menus and submenus, perform the following actions as required:

**RIGHT:** Navigates to the next menu or submenu items on the right.

**LEFT:** Navigates to the next menu or submenu items on the left.

**SEL:** Enters submenu.

**UP:** Exits from a submenu.

## 2.4 STM8L1528-EVAL board jumper configuration

To be able to run the STM8L1528-EVAL demo correctly, configure the following STM8L1528-EVAL board jumpers as follows:

- JP1: not fitted
- JP2: fitted in SWIM position
- JP3: Audio DAC1: fitted
- JP4: fitted in IDD position
- JP5: not fitted
- JP6: fitted
- JP7: not fitted
- JP8: not fitted
- JP9: fitted
- JP10: fitted
- JP11 and JP12: are fitted in RS232 position

### 3 Demonstration applications

#### 3.1 Menu overview

The *Figure 2* shows all the menu and submenus of the demonstration applications.

**Figure 2. Menu overview**

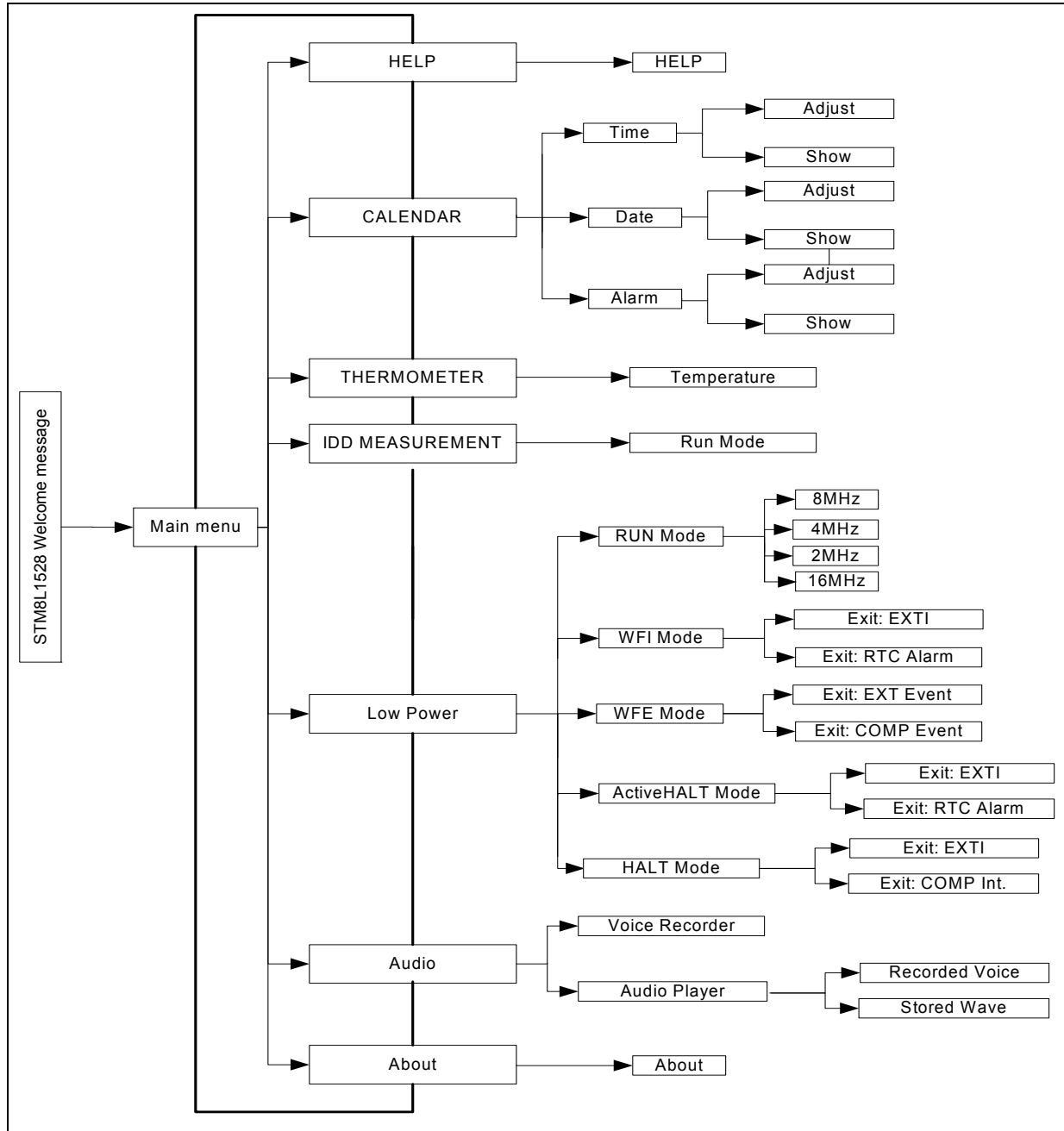

The following sections provides a detailed description of each part of the demonstration firmware.

### 3.2 Welcome screen and main menu

After a board reset, a welcome message is displayed on the first line of the LCD screen, the ST logo is displayed moving on the second line (see [Figure 3](#)).

**Figure 3. Welcome message**

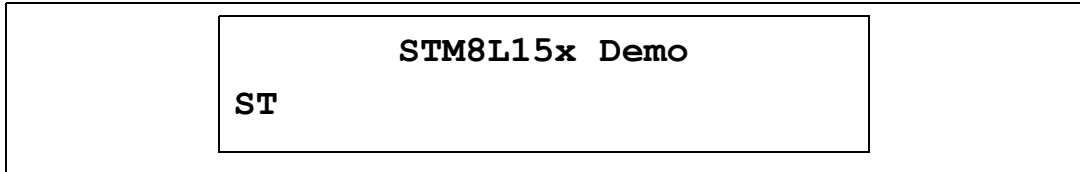

The main menu is then activated and the message shown in [Figure 4](#) is displayed:

**Figure 4. Main menu**

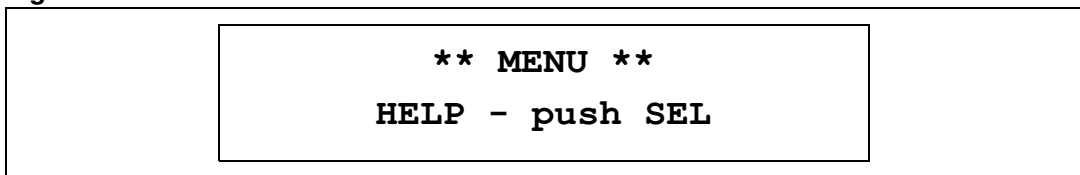

### 3.3 Help mode

Pressing **SEL** from the main menu enters the *Help* mode. The following messages are displayed sequentially on the LCD screen with a few-second delay:

**Figure 5. Help mode submenus**

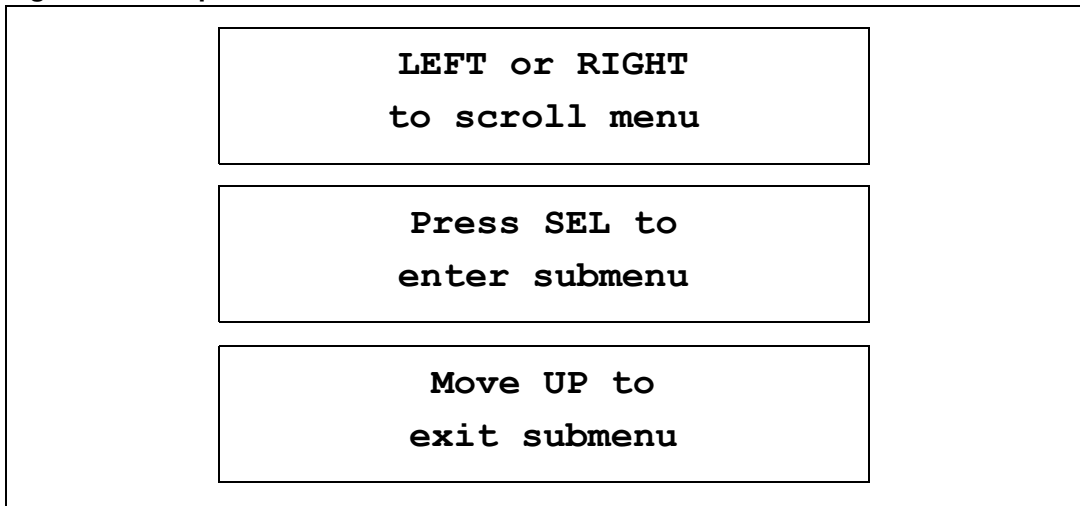

To exit this demo, press the joystick **UP**.

## 3.4 Calendar demo

The STM8L15x features a real-time clock (RTC) including an independent BCD timer/counter, time-of-day clock /calendar, a software programmable alarm, and a periodic programmable wakeup flag with interrupt capabilities that can be used to exit the device from Low power modes.

The calendar submenus allow to configure the system time, date and alarm.

### 3.4.1 Setting the time

The *TIME* submenu offers two options allowing to adjust and display the current time. Once set, the time is used to configure the RTC time.

#### Time adjust

Use the *Time adjust* option either to modify the current time, or to change the time to the current time after the STM8L1528-EVAL evaluation board is powered up.

1. To set the time, select the *Time adjust* option. The *Time adjust* submenu is then displayed to show the current time value. (see [Figure 6](#)).
2. Enter the first digit of the hour field:
  - Pressing the joystick **UP** increments the current digit value.
  - Pressing the joystick **DOWN** decrements the current digit value.The digit value is limited to a range depending on the time field (hours, minutes or seconds).
3. After selecting the digit value press **SEL**. The cursor then jumps automatically to the next digit.
4. When all the time digits are set, the *Time adjust* submenu is displayed again to show the current time. (see [Figure 6](#)).

**Figure 6. Time adjust message**

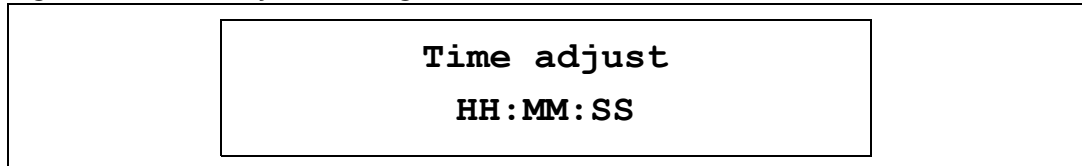

#### Time show

Select *Time show* to display the current time. The time start counter from (00:00:00) after the first run for the demo the time is cleared if the STM8L1528-EVAL evaluation board is powered down. The *Time adjust* option is used to configure the time.

When this option is selected, the following message is displayed on the LCD screen:

**Figure 7. Time show message**

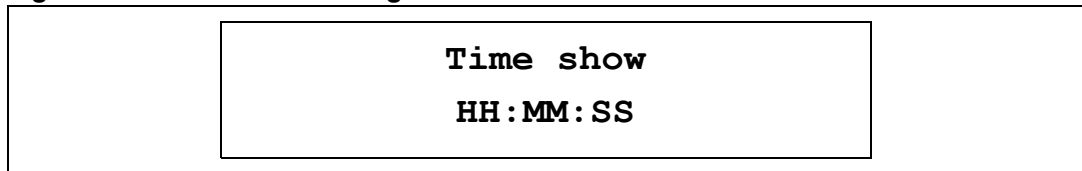

To exit from the *Time show* submenu press the joystick **UP**.

### 3.4.2 Setting the date

The *DATE* submenu offers two options allowing to adjust and display the current date. Once set, the time is used to configure the RTC date.

#### Date Adjust

Use the *Date adjust* option to modify the current date, or to change the default date (09/17/2010) to the current date after the STM8L1528-EVAL evaluation board is powered up.

1. To set the current date, select the *Date adjust* option. The date is then displayed on 8 digits: MM/DD/YYYY (see *Figure 8*).
2. Enter the first digit of the month field:
  - Pressing the joystick **UP** increments the current digit value.
  - Pressing the joystick **DOWN** decrements the current digit value.
 The digit value is limited to a range depending on the date field (month, day or year).
3. After selecting the digit value press **SEL**. The cursor then jumps automatically to the next digit.
4. When all the date digits are set, the *Date adjust* submenu is displayed again to show the current date. (see *Figure 8*).

**Figure 8. Date Adjust message**

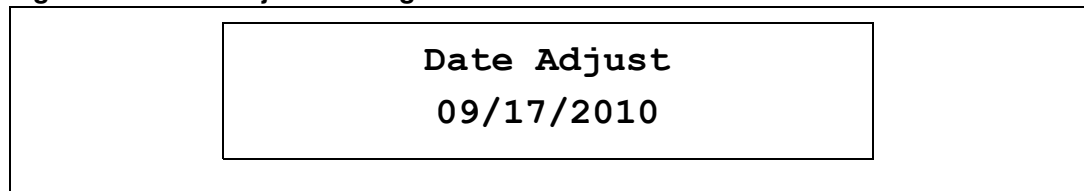

#### Date show

Select *Date show* to display the current date. After power-up, the default date (09/17/2010) is displayed till the Date adjust option is used to configure the current date.

The following message is displayed on the LCD screen when this submenu is selected:

**Figure 9. Date Adjust message**

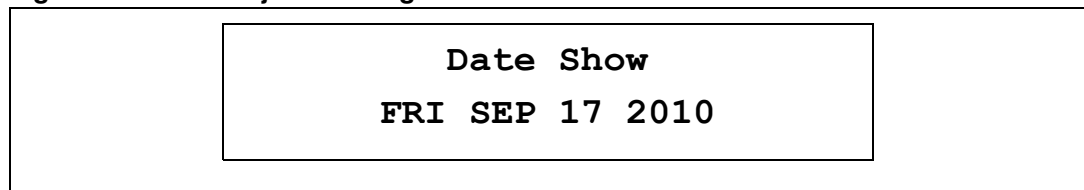

To exit from this sub menu press the joystick **UP** push.



### 3.4.3 Setting the alarm

Use the *ALARM* submenu to configure the alarm seconds, minutes and hours.

This submenu offers two options allowing to display or adjust the current alarm.

#### Alarm adjust

The *Alarm adjust* option is similar to *Time adjust*.

After selecting *Alarm adjust*, or after setting the alarm, the message shown in [Figure 10](#) is displayed.

**Figure 10. Alarm Adjust message**

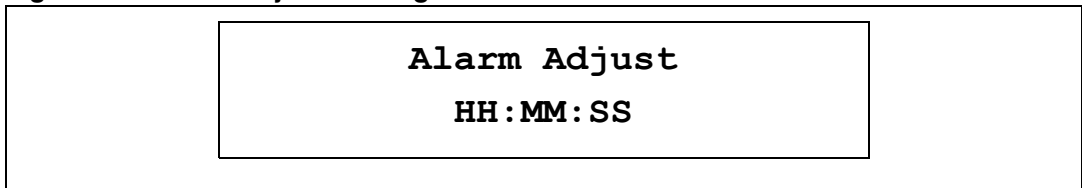

#### Alarm show

Select the *Alarm show* option to display the current alarm. After power-up, the default alarm time (00:00:00) is displayed till the *Alarm adjust* option is used to enter a new alarm time.

The following message is displayed on the LCD screen when this submenu is selected:

**Figure 11. Alarm show message**

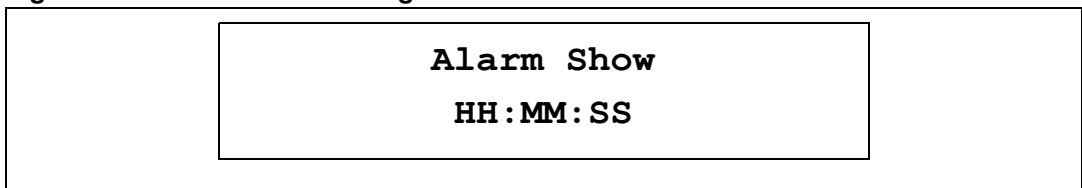

To exit from this sub menu press the joystick **UP**.

- Note:*
- 1 When an alarm occurs, the alarm wave is played.
  - 2 The alarm can be used also to wake up the system from WFI or Active-halt.

### 3.5 Thermometer demo

The STM8L15x microcontroller has one embedded I<sup>2</sup>C peripheral that can be connected to any device supporting the I<sup>2</sup>C protocol including the system management bus (SMBus) mode. An STLM75 (or compatible devices) I<sup>2</sup>C temperature sensor is mounted on the STM8L1528-EVAL board and used to get instantaneous external temperature (-55°C to 125°C).

Once the **THERMOMETER** menu has been selected by pressing the SEL push-button, the message shown in *Figure 12* is displayed on the LCD.

**Figure 12. Thermometer message**

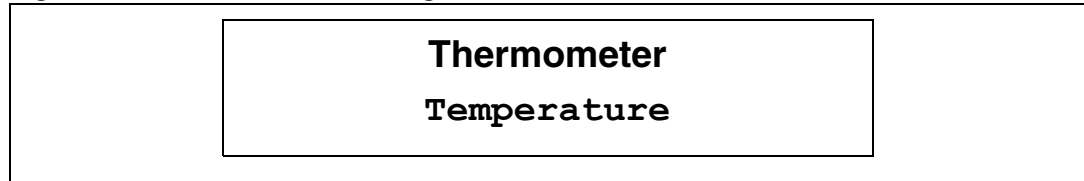

Then the temperature value is displayed in Celsius as shown in *Figure 13*.

**Figure 13. Temperature in Celsius message**

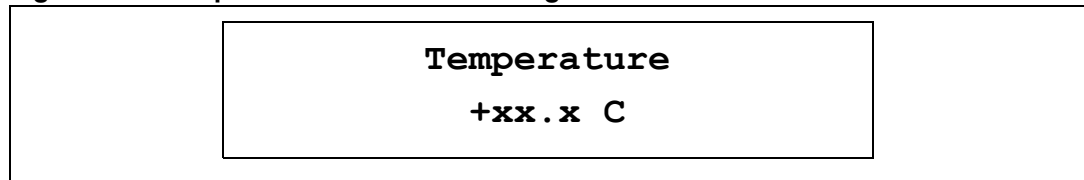

When the joystick **RIGHT** is pressed the temperature in degrees Fahrenheit is displayed on LCD screen as shown in *Figure 14* for two seconds then the temperature in degrees Celsius is *displayed again*.

**Figure 14. Temperature in Celsius message**

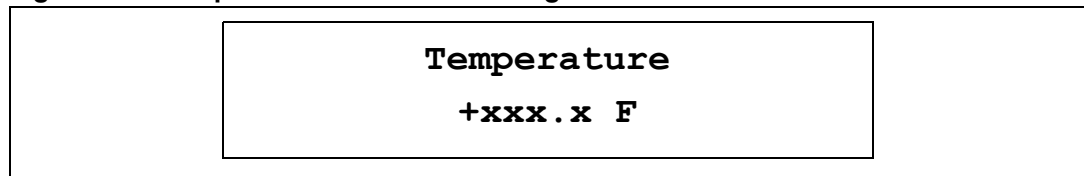

Thanks to STM8 I2C SMBus feature, we can easily monitor the temperature variations. This is managed by the SMBus Alert which is generating a dedicated interrupt informing the system that the temperature is out of the selected ranges. This is very useful when a higher temperature needs an emergency intervention like in a critical systems (motor control, medical...).

If the temperature exceeds the over-limit high (TEMPERATURE\_TOS: Over Limit Temperature) the SMBus alert interrupt is generated and the following warning message as shown in *Figure 15* is displayed on the LCD screen.

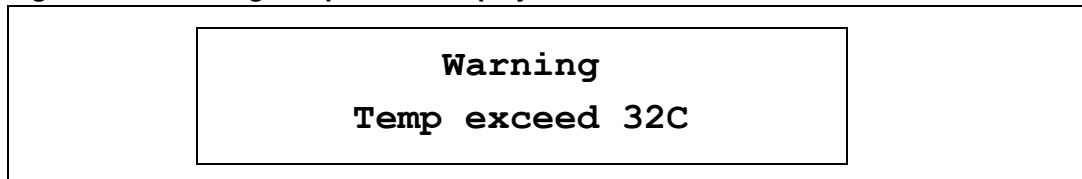
**Figure 15. Warning Temperature display**

The messages shown in [Figure 15](#) is displayed on the LCD when the temperature goes under the over limit low (TEMPERATURE\_THYS: Hysteresis Temperature).

The user can configure the TOS and THYS thanks to a dedicated define values in the code. By default the STM8L1528-EVAL demo is setting them to (see demo\_thermometer.c file):

```
#define TEMPERATURE_THYS 31
#define TEMPERATURE_TOS 32
```

To exit this demo, press the joystick **UP**.

*Note:* Any hardware trouble on the board with the temperature sensor is detected by a test. In this event, the message shown in [Figure 16](#) is displayed.

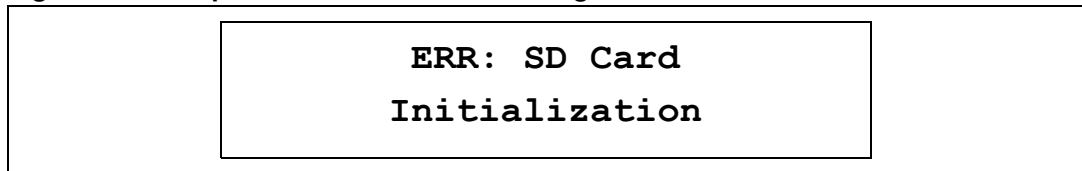
**Figure 16. Temperature sensor error message**

### 3.6 I<sub>DD</sub> measurement demo

The STM8L15x microcontroller features an ADC peripheral. It measures the I<sub>DD</sub> current in Run mode by using the I<sub>DD</sub> measurement circuit available on the Root part number 1 board.

1. Select the IDD MEASUREMENT menu by pressing SEL from the main menu. The message shown in [Figure 17](#) is then displayed on the LCD screen.

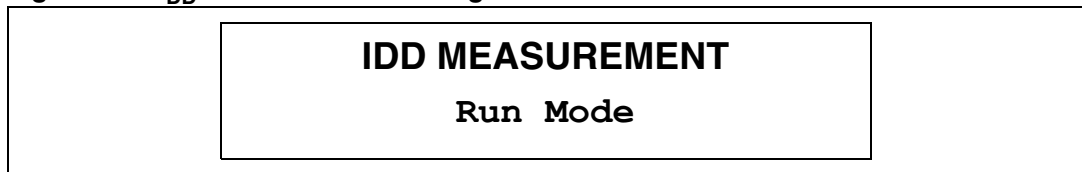
**Figure 17. I<sub>DD</sub> measurement message**

2. Press **SEL** to display the current value of I<sub>DD</sub> in Run mode on the LCD screen (see [Figure 18](#)). I<sub>DD</sub> value is periodically refreshed.

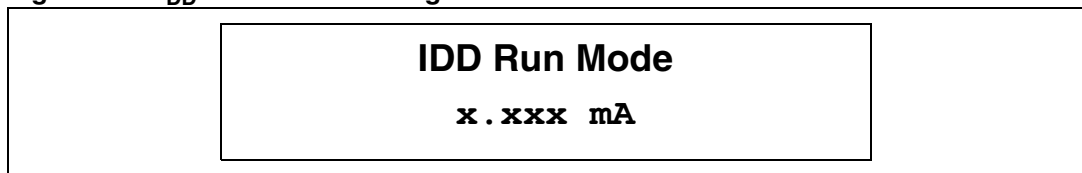
**Figure 18. I<sub>DD</sub> Run mode message**

*Note:* Make sure that the JP4 jumper is installed in the I<sub>DD</sub> position before running the I<sub>DD</sub> measurement demo.

### 3.7 Low power demo

The STM8L15x features five low power modes to achieve the best compromise between low power consumption, short startup time and available wakeup sources. The objective of the LOW POWER menu is to demonstrate how to enter the device in these low power modes and exit with different wakeup sources. Power consumption and startup time optimization are not targeted by this application.

#### 3.7.1 Run mode

The *RUN* mode submenu demonstrates the behavior of an application running at different clock frequencies. The demo controls on-board LEDs that blink at the clock frequency. The current value of the clock frequency in Run mode is also displayed on the LCD screen (see [Figure 19](#)).

**Figure 19. Run mode frequency message**

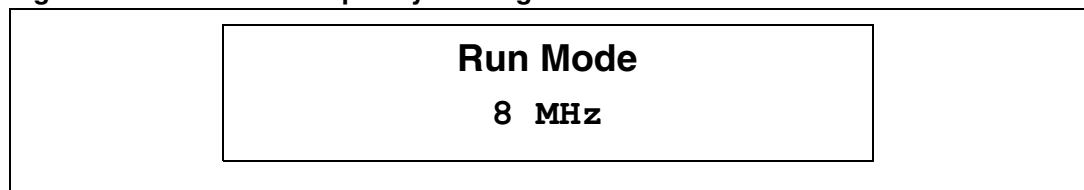

The *Run mode* submenu contains four submenu items:

- **8 MHz:** the application runs at 8 MHz.
- **4 MHz:** the application runs at 4 MHz.
- **2 MHz:** the application runs at 2 MHz.
- **16 MHz:** the application runs at 16 MHz.

Press **SEL** to select one of the listed Run mode clock frequency.

Press **UP** to exit from the selected mode and return to the 16 MHz default clock frequency.

#### 3.7.2 Wait for interrupt mode

This menu allows to put the STM8L15x in Wait for interrupt mode (WFI). The software executes the specific sequence of instructions required to enter WFI mode: the CPU clock is stopped, and selected peripherals go on running.

In this demonstration, there are two ways to exit from WFI mode:

- An external interrupt (EXTI) generated by pressing **SEL** on the joystick exits the STM8L15x from WFI mode:

The LEDs blink until **SEL** is pressed from the WFI menu (see [Figure 20](#)). The system then enters WFI mode and the following message is displayed on the LCD:

**Figure 20. WFI wait for EXTI message**



The STM8L15x remains in WFI mode unless joystick **SEL** is pressed. The MCU then exits from WFI mode, the system clock frequency is set to 16 MHz, and the application execution resumes. The following message is displayed on the LCD screen:

**Figure 21. Exit from WFI with EXTI message**

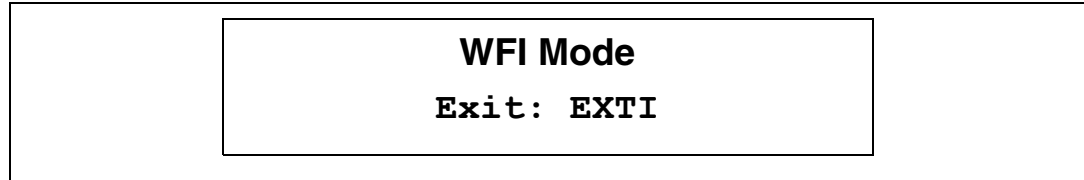

*Note:* If an alarm occurs when the system is in WFE mode, it is delayed until the EXTI interrupt wakes up the device; then all LEDs are ON and a sound is played for ~10s.

- The RTC alarm is used to wake up the STM8L15x from WFI mode. The LEDs blink until **SEL** is pressed from the WFI menu (see [Figure 22](#)). The system then enters WFI mode and the following message is displayed on the LCD:

**Figure 22. WFI wait for alarm message**

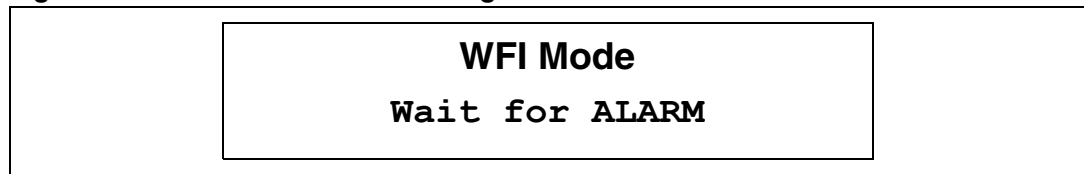

When the alarm time is reached, the system exits from WFI mode, the system clock frequency is set to 16 MHz, and the application execution resumes. The message shown in [Figure 23](#) is then displayed on the LCD screen:

**Figure 23. Exit from WFI with alarm message**

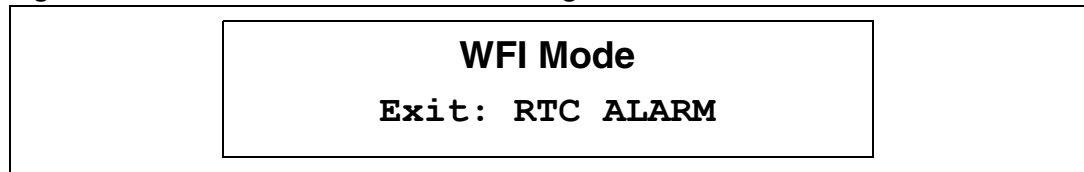

### 3.7.3 Wait for event mode

This menu allows to put the STM8L15x in Wait for event mode (WFE). The software executes the specific sequence of instructions required to enter WFE mode: the CPU clock is stopped, and selected peripherals go on running.

In this demonstration, there are two ways to exit from WFE mode:

- An external interrupt (EXTI) generated by pressing joystick **SEL** exits the STM8L15x from WFE mode. The LEDs blink until **SEL** is pressed from the WFE menu (see [Figure 24](#)). The system then enters WFE mode and the following message is displayed on the LCD:

**Figure 24. WFE wait for EXTI message**



The STM8L15x remains in WFE mode unless the **SEL button** is pressed. The MCU then exits from WFE mode, the system clock frequency is set to 16 MHz, and the application execution resumes. The following message is displayed on the LCD screen:

**Figure 25. Exit from WFE with EXTI message**

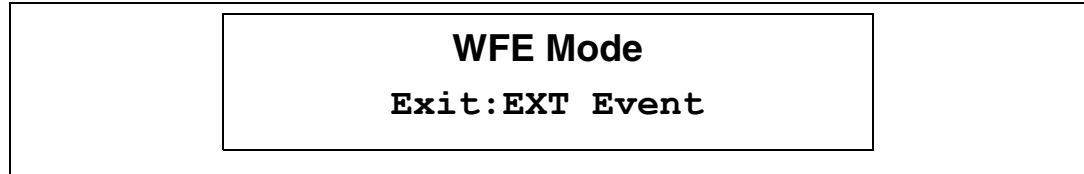

- A Comparator 1 interrupt can also exit the STM8L15x from WFE mode  
This interrupt is generated when the comparator non inverting input (connected to RV3) exceeds the internal reference voltage which is set to 1.22 V.  
The LEDs blink until **SEL** is pressed from WFE menu (see [Figure 26](#)). The system then enters WFE mode and the following message is displayed on the LCD:

**Figure 26. WFE wait for comparator interrupt message**

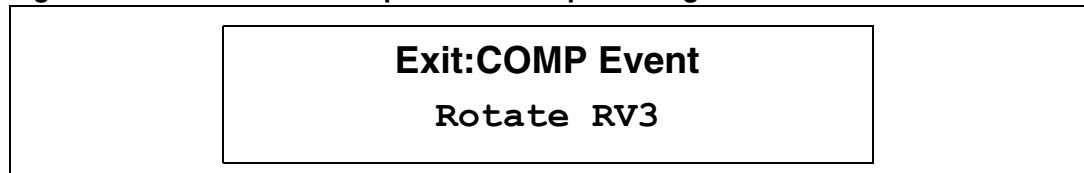

When Comparator 1 non inverting input exceeds the internal reference voltage, the system exits from WFE mode, and the application execution resumes. The message shown in [Figure 27](#) is then displayed on the LCD screen:

**Figure 27. Exit from WFE with comparator interrupt message**

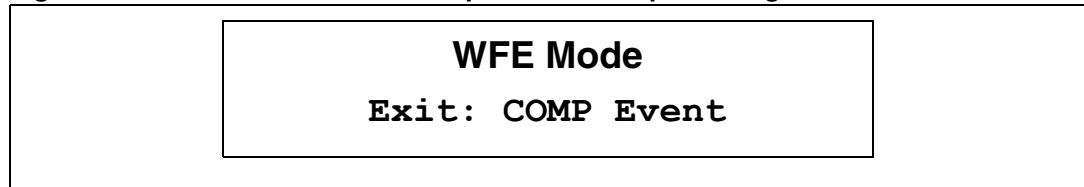

*Note: If an alarm occurs when the system is in WFE mode, it is delayed until the occurrence of the wake up event; then all LEDs are ON and a sound is played for ~10s.*

### 3.7.4 Active-Halt mode

This menu allows to put the STM8L15x in Active-halt mode. The software executes the specific sequence of instructions required to enter Active-halt mode: the CPU clock is stopped except for the RTC.

In this demonstration, there are two ways to exit from Active-halt mode:

- An external interrupt (EXTI) generated by pressing **SEL** on the joystick exits the STM8L15x from Active-halt mode:  
The LEDs continue blinking until **SEL** is pressed from the Active-halt menu (see [Figure 28](#)). The system then enters Active-halt mode and the following message is displayed on the LCD:

**Figure 28. Active Halt wait for EXTI message**



The MCU remains in Active-halt mode unless the **SEL** button is pressed. When **SEL** is pressed, the MCU exits from Active-halt mode, the system clock frequency is set to 16 MHz, and the application execution resumes.

The following message is displayed on the LCD screen:

**Figure 29. Exit from Active-halt with EXTI message**



*Note: If an alarm occurs when the system is in Active-halt mode, it is delayed until the EXTI interrupt wakes up the device; then all LEDs are ON and a sound is played for ~10s.*

- The RTC alarm wakes up the MCU from Active-halt mode. The LEDs blink until **SEL** is pressed from the Active-halt menu (see [Figure 30](#)). The system then enters Active-halt mode and the following message is displayed on the LCD.

**Figure 30. Active Halt wait for alarm message**



When the alarm time is reached, the system exits from Active-halt mode, the system clock frequency is set to 16 MHz, and the application execution resumes. The message shown in [Figure 31](#) is displayed:

**Figure 31. Exit from Active-halt with alarm message**



### 3.7.5 Halt mode

This menu allows to put the STM8L15x in Halt mode. The software performs the specific sequence of instructions required to enter Halt mode: the CPU and peripheral clocks are stopped, and the device remains powered on.

In this demonstration, there are two ways to exit from halt mode:

- An external interrupt (EXTI) generated by pressing **SEL** on the joystick exits the STM8L15x from halt mode:  
The LEDs blink until **SEL** is pressed from Halt menu. The system then enters halt mode and the following message is displayed on the LCD:

**Figure 32. Halt wait for EXTI message**

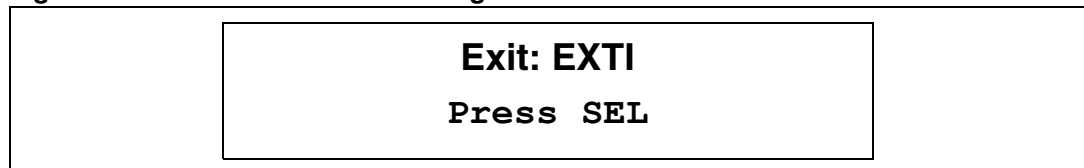

The STM8L15x remains in Halt mode unless the **SEL** button is pressed. The MCU then exits from Halt mode, the system clock is set to 16 MHz, and the application execution resumes. The following message is displayed on the LCD:

**Figure 33. Exit from Halt with EXTI message**



- A Comparator 1 interrupt can also exit the STM8L15x from Halt mode  
This interrupt is generated when the non inverting input exceeds the internal reference voltage.  
The LEDs blink until **SEL** is pressed from the Halt menu (see [Figure 34](#)). The system then enters Halt mode and the following message is displayed on the LCD:

**Figure 34. Halt wait for comparator interrupt message**



When Comparator 1 non inverting input exceeds the internal reference voltage, the system exits from Halt mode, and the application execution resumes. The message shown in [Figure 35](#) is then displayed on the LCD screen:

**Figure 35. Exit from Halt with comparator interrupt message**

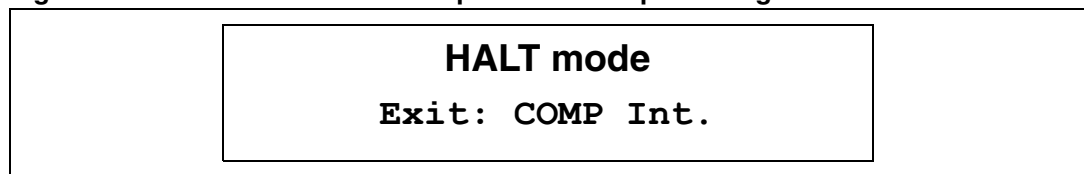



## 3.8 Audio demo

### 3.8.1 Voice recorder demo

The STM8L15x microcontroller features timers and an ADC which can be used respectively for timing and signal acquisition.

In this demo, Timer 1 (TIM1) is used to generate an update interrupt every 45.35  $\mu$ s (22.05 kHz), which corresponds to the voice sampling period. This update event triggers the ADC voice acquisition. Voice data is saved on the on-board SPI Flash memory.

When the Voice Recorder is selected from the AUDIO menu by pressing **SEL** on the joystick, the following message is displayed on the LCD screen:

**Figure 36. Start voice recorder message**

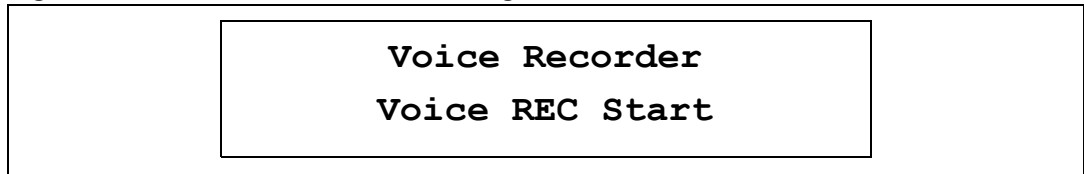

This message remains displayed until **SEL** is pressed. The STM8L15x then starts erasing the voice data previously stored on the on-board Flash memory. The message shown in [Figure 37](#) remains displayed until the erase operation is complete.

**Figure 37. Erase Flash message**

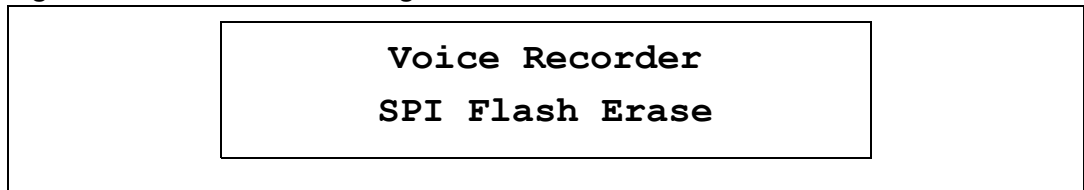

When the erase operation is complete, the message shown in [Figure 38](#) is displayed:

**Figure 38. Voice recorder message**

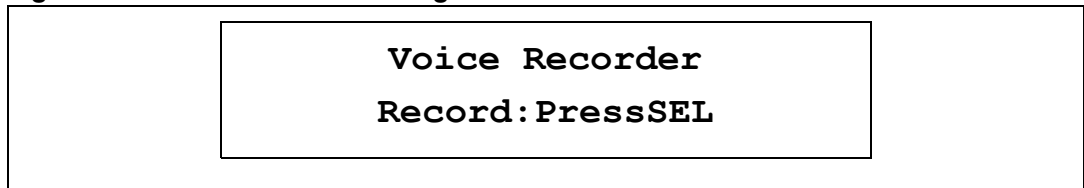

When **SEL** is pressed, the STM8L15x starts recording voice and displays the message shown in [Figure 39](#):

**Figure 39. Stop voice recorder message**

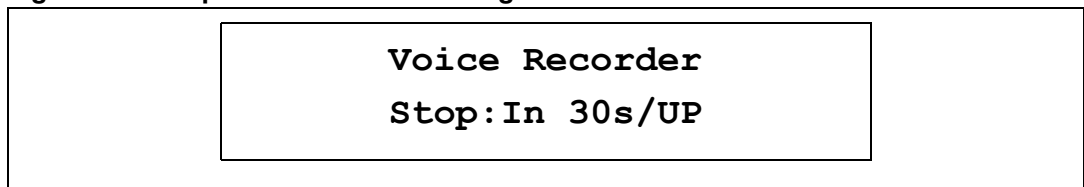

To stop recording, press the **joystick UP**, otherwise the STM8L15x will stop recording automatically after 30 s and the message shown in [Figure 40](#) will be displayed:

**Figure 40. End voice recorder message**

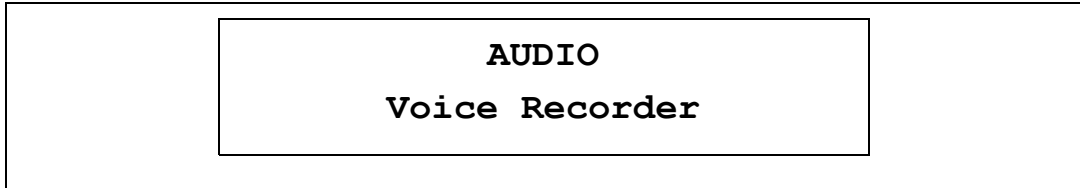

### 3.8.2 Voice player demo

The STM8L15x microcontroller features an embedded DAC which can be used to generate output signals.

In this demo, the DAC regenerates the voice signal recorded in the SPI Flash memory. Timer 4 (TIM4) triggers the DAC to generate the voice signal every 45.35  $\mu$ s (22.05 kHz) which corresponds to the voice sampling period.

When the Recorded voice is selected from the Audio Player submenu by pressing the **SEL** on the joystick, The following message remains displayed unless **SEL** is pressed.

**Figure 41. Audio Player menu message**

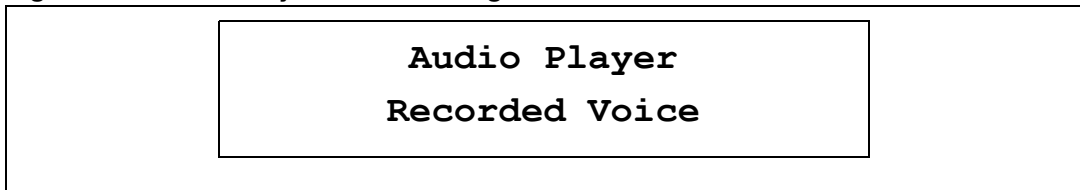

When **SEL** is pressed, the STM8L15x starts playing the voice, and the message shown in [Figure 42](#) is displayed.

**Figure 42. Play voice recorded message**

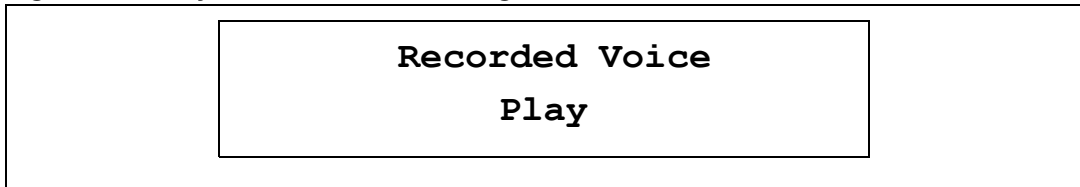

At first time when running the recorded voice demo, the STM8L15x check for the existence for a record in the external SPI Flash memory and play it, otherwise the message shown in [Figure 43](#) is displayed for two seconds then voice player menu is displayed again.

**Figure 43. No recorded voice message**

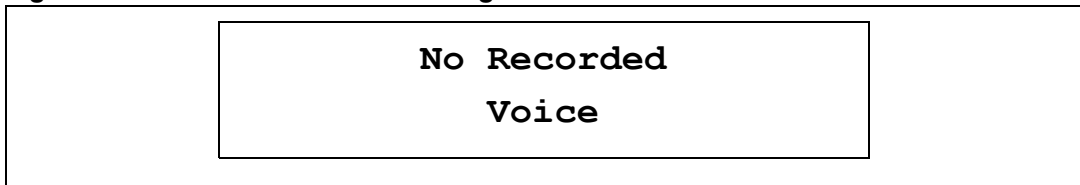

To stop the voice player demo, press the joystick **UP**. The message shown on [Figure 41](#) is then displayed. Otherwise, the STM8L15x will stop automatically at the end of the wave.

### 3.8.3 Wave player demo

The STM8L15x microcontroller has an embedded DAC which can be used to generate output signals.

In this demo, any wave file stored under the USER folder in the microSD card can be opened using the file system PetitFatFS and transferred to the internal RAM by block (512 bytes) using the DMA and the SPI interface. Timer 4 (TIM4) triggers the DAC to generate the wave signal. The voice sampling period is read from the Wave File Header. An audio amplifier is connected to the DAC interface to play the stored wave files. This demo reads all wave files from "USER" directory and displays only the .WAV files having the following format:

- Audio Format: PCM (an uncompressed wave data format in which each value represents the amplitude of the signal at the time of sampling.)
- Sample rate: may be 8000, 11025, 22050 or 44100 Hz.
- Bits Per Sample: 8-bit (Audio sample data values are in the range [0-255]).
- Number of Channels: 1 (Mono)

The maximum wave files number that can be read from the microSD card is 3 files selected by alphabetic order.

When the Stored wave is selected from the Audio Player submenu by pressing the **SEL** on the joystick, The following message remains displayed unless **SEL** is pressed.

**Figure 44. Stored wave message**



When **SEL** is pressed, the system checks if an SD card memory is available in the connector CN15. If there is no card detected, the Stored Wave demo will not start and the message shown in [Figure 45](#) is displayed on the LCD for two seconds then the Audio Player submenu is *displayed again*.

**Figure 45. Stored wave message**

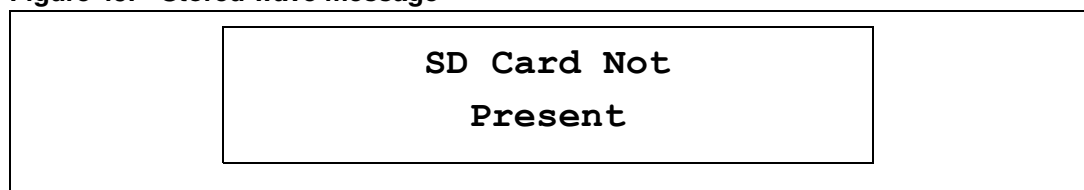

Otherwise, if SD card is detected in the connector CN15 the available wave interface is displayed as shown in [Figure 46](#).

**Figure 46. Available wave message**

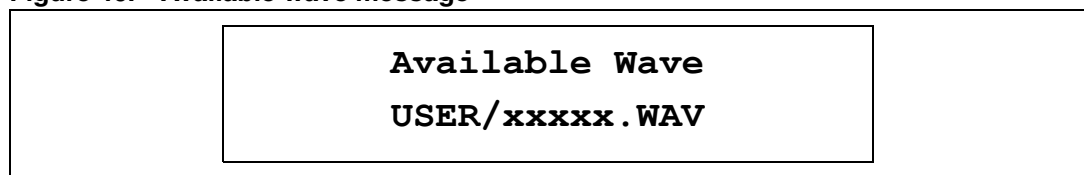

At this application level, pressing:

- the SEL push-button starts playing the selected wave
- the UP push-button exit the submenu
- the LEFT push-button decrements the wave index
- the RIGHt push-button increment the wave index

Once the play command is prompted, the submenu shown in [Figure 47](#) is displayed.

**Figure 47. Play wave message**

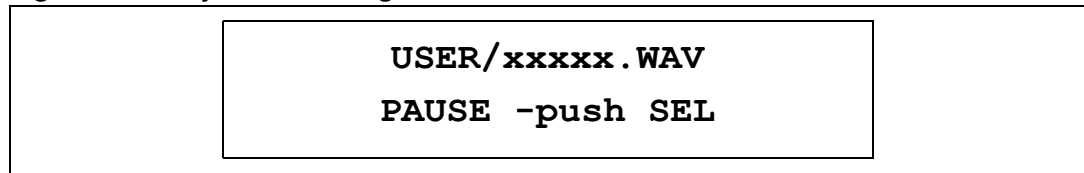

When the audio stream is paused, the menu in [Figure 48](#) is displayed.

**Figure 48. Pause wave message**

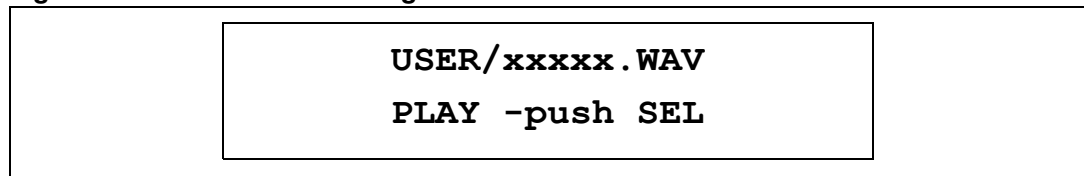

To resume playing, press the SEL push-button and the menu shown in [Figure 47](#) is displayed.

When the audio stream is stopped, the stream position is reset and the menu shown in [Figure 44](#) is displayed.

*Note: If the SD card is removed, the demo will stop and the LCD screen displays the message shown in [Figure 49](#) for two seconds. Then the Audio Player submenu is displayed again.*

**Figure 49. SD card removed message**

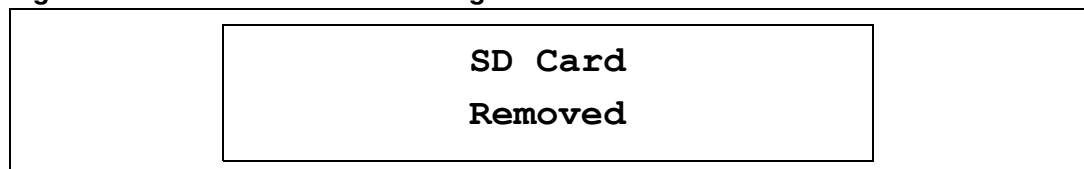

### 3.9 About menu

This menu shows the firmware version. When this submenu is selected the message shown in [Figure 50](#) is displayed on the LCD screen:

**Figure 50. Displaying the demonstration firmware version**

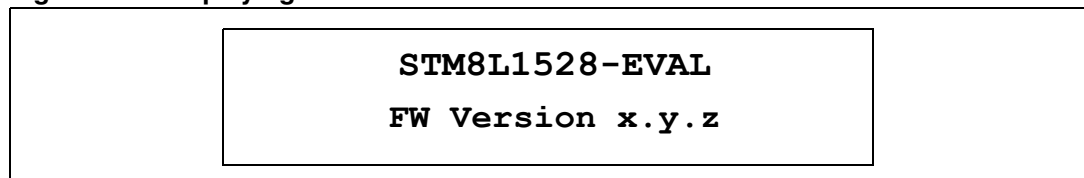

Press the joystick **UP** to exit this menu.

## 4 Upgrading the demonstration firmware

### 4.1 Programming the media files

The STM8L1528-EVAL board comes with an MicroSD card memory preprogrammed with audio resources used by the demonstration. However you can load your audio (\*.wav) files in the “USER” directory, providing that these file formats are supported by the demonstration. For more details please refer to [Section 3.8.3: Wave player demo on page 19](#).

**Figure 51. SD card directory organization**

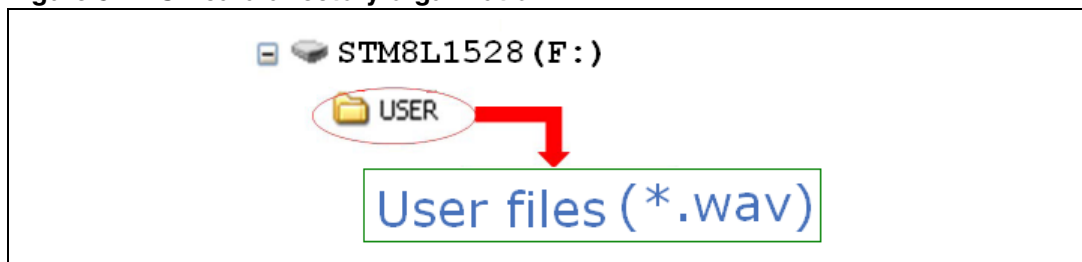

The default content of the media files (USER directory) is located in the Binary\Media folder. To reprogram the MicroSD card, simply copy the content of the Binary\Media folder to your own SD memory.

### 4.2 Programming the demonstration

To upgrade the demonstration firmware running on your board, perform the following steps:

1. Download the latest version of STM8L1528-EVAL demonstration firmware and related user manual from [www.st.com/mcu](http://www.st.com/mcu).
2. Extract the content of the downloaded zip file to the directory of your choice.
3. Power on the STM8L1528-EVAL board and connect it to the debug instrument.
4. Select the folder corresponding to your preferred toolchain (STVD, EWARMv6 or RIDE).
5. Open the project and rebuild all sources.
6. Load the project image through your debugger.
7. Restart the evaluation board (Press B1: reset button).

*Note:* You can also load a binary file of the demonstration firmware (.hex) by using the STVP toolchain (refer to the STVP online help for details). The binary file is available under `STM8L1528-EVAL_FW\Utilities\Binary`.

## 5 STM8L15x peripherals used

[Table 2](#) lists the STM8L15x peripherals used in each demo.

**Table 2. Peripherals used**

Peripheral	Demo
ADC1	I <sub>DD</sub> measurement, Voice recorder
DAC	Audio Player
COMP 1	Low power
External interrupts (EXTI)	Low Power
GPIO	All demo
Clock controller	All demo
I2C1	Thermometer +Audio Player
TIM1	Voice recorder
TIM2	All demos (time base)
TIM4	Audio Player
SPI1	All demos + Audio Player +Voice recorder
RTC	Calendar

## 6 Revision history

**Table 3. Document revision history**

Date	Revision	Changes
27-Sep-2010	1	Initial release.

**Please Read Carefully:**

Information in this document is provided solely in connection with ST products. STMicroelectronics NV and its subsidiaries ("ST") reserve the right to make changes, corrections, modifications or improvements, to this document, and the products and services described herein at any time, without notice.

All ST products are sold pursuant to ST's terms and conditions of sale.

Purchasers are solely responsible for the choice, selection and use of the ST products and services described herein, and ST assumes no liability whatsoever relating to the choice, selection or use of the ST products and services described herein.

No license, express or implied, by estoppel or otherwise, to any intellectual property rights is granted under this document. If any part of this document refers to any third party products or services it shall not be deemed a license grant by ST for the use of such third party products or services, or any intellectual property contained therein or considered as a warranty covering the use in any manner whatsoever of such third party products or services or any intellectual property contained therein.

**UNLESS OTHERWISE SET FORTH IN ST'S TERMS AND CONDITIONS OF SALE ST DISCLAIMS ANY EXPRESS OR IMPLIED WARRANTY WITH RESPECT TO THE USE AND/OR SALE OF ST PRODUCTS INCLUDING WITHOUT LIMITATION IMPLIED WARRANTIES OF MERCHANTABILITY, FITNESS FOR A PARTICULAR PURPOSE (AND THEIR EQUIVALENTS UNDER THE LAWS OF ANY JURISDICTION), OR INFRINGEMENT OF ANY PATENT, COPYRIGHT OR OTHER INTELLECTUAL PROPERTY RIGHT.**

**UNLESS EXPRESSLY APPROVED IN WRITING BY AN AUTHORIZED ST REPRESENTATIVE, ST PRODUCTS ARE NOT RECOMMENDED, AUTHORIZED OR WARRANTED FOR USE IN MILITARY, AIR CRAFT, SPACE, LIFE SAVING, OR LIFE SUSTAINING APPLICATIONS, NOR IN PRODUCTS OR SYSTEMS WHERE FAILURE OR MALFUNCTION MAY RESULT IN PERSONAL INJURY, DEATH, OR SEVERE PROPERTY OR ENVIRONMENTAL DAMAGE. ST PRODUCTS WHICH ARE NOT SPECIFIED AS "AUTOMOTIVE GRADE" MAY ONLY BE USED IN AUTOMOTIVE APPLICATIONS AT USER'S OWN RISK.**

Resale of ST products with provisions different from the statements and/or technical features set forth in this document shall immediately void any warranty granted by ST for the ST product or service described herein and shall not create or extend in any manner whatsoever, any liability of ST.

ST and the ST logo are trademarks or registered trademarks of ST in various countries.

Information in this document supersedes and replaces all information previously supplied.

The ST logo is a registered trademark of STMicroelectronics. All other names are the property of their respective owners.

© 2010 STMicroelectronics - All rights reserved

STMicroelectronics group of companies

Australia - Belgium - Brazil - Canada - China - Czech Republic - Finland - France - Germany - Hong Kong - India - Israel - Italy - Japan - Malaysia - Malta - Morocco - Philippines - Singapore - Spain - Sweden - Switzerland - United Kingdom - United States of America

[www.st.com](http://www.st.com)

