

TINA3-WW

~55° wide beam optimized for CREE XP-E.
Assembly with holder and installation tape.

TECHNICAL SPECIFICATIONS:

Dimensions	Ø 16.1 mm
Height	7.1 mm
Fastening	pin, tape
Colour	white
Box size	470 x 240 x 105 mm
Box weight	3.2 kg
Quantity in Box	2016 pcs
ROHS compliant	yes ⓘ

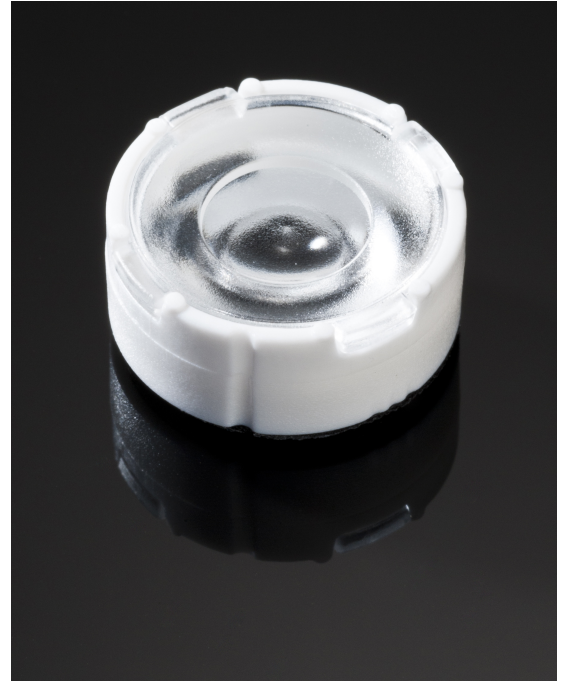

MATERIAL SPECIFICATIONS:

Component	Type	Material	Colour
TINA3-WW	Lens	PMMA	clear
TINA3-HLD-PIN-TAPE-XP	Holder	PC	white
TINA-TAPE3	Tape	PU tape	black

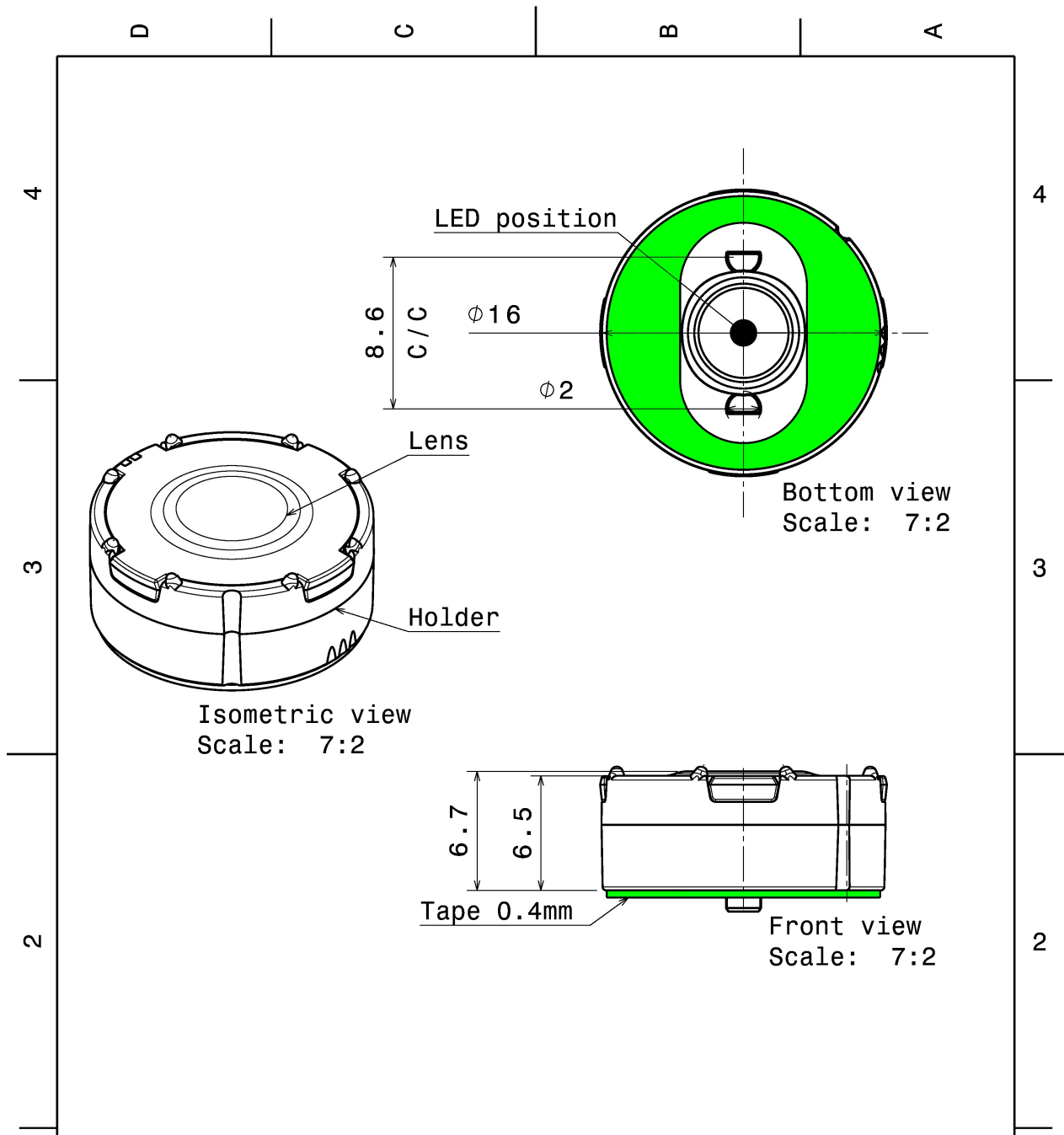

Tolerances if not otherwise shown
According to DIN ISO 2768-1
Linear measures:
Up to 30mm class M, otherwise class C.
According to DIN ISO 2768-2
Form and position: class L

LEDiL Ledil Oy
Salorankatu 10
FIN 24240 SALO
Finland

THIRD ANGLE PROJECTION:

DRAWING TITLE
FA11903_TINA3-VV

This drawing is the property of LEDiL Oy. It may not be reproduced, copied or communicated without a written agreement with LEDiL Oy."

SIZE	PART NUMBER
A4	FA11903

SCALE	7:2	WEIGHT	-	SHEET	1/1
-------	-----	--------	---	-------	-----

PHOTOMETRIC DATA (MEASURED):

CREE 

LED XM-L
FWHM 56.0°
Efficiency 89 %
Peak intensity 0.850 cd/lm
Required components:

CREE 

LED XM-L2
FWHM 56.0°
Efficiency 89 %
Peak intensity cd/lm
Required components:

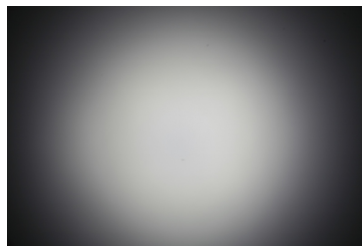

CREE 

LED XP-L
FWHM 53.0°
Efficiency 91 %
Peak intensity 0.900 cd/lm
Required components:

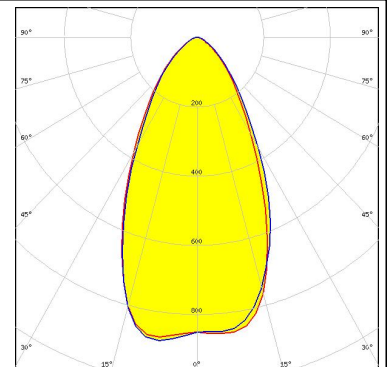
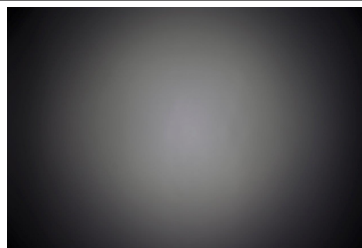

CREE 

LED XP-L HI
FWHM 54.0°
Efficiency 91 %
Peak intensity 0.990 cd/lm
Required components:

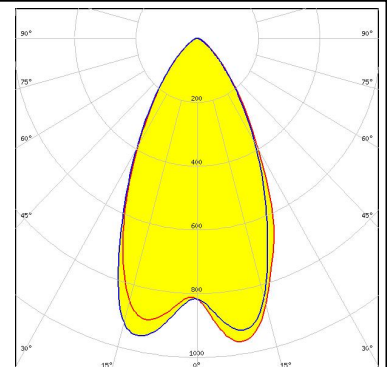
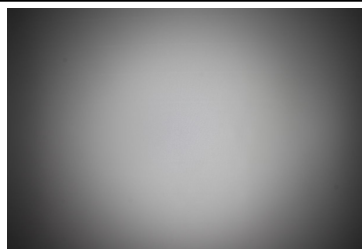

PHOTOMETRIC DATA (MEASURED):

CREE 

LED XT-E
FWHM 46.0°
Efficiency 92 %
Peak intensity 1.200 cd/lm
Required components:

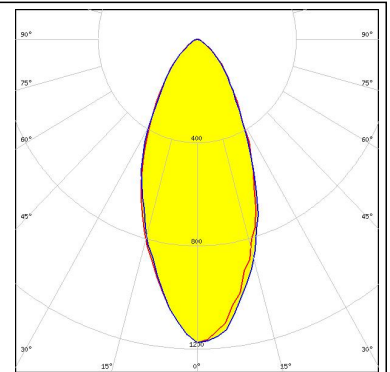
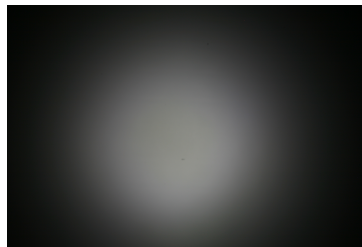

NICHIA 

LED NS9x383
FWHM 65.0°
Efficiency 90 %
Peak intensity 0.740 cd/lm
Required components:

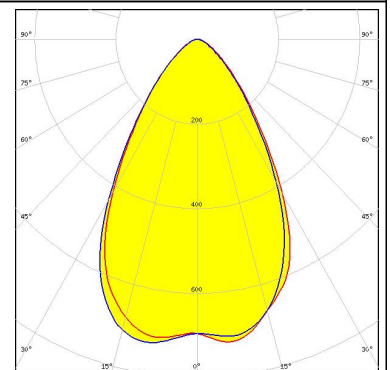
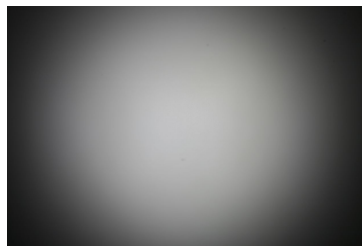

PHOTOMETRIC DATA (SIMULATED):



LED XD16 2x2 cluster
FWHM 61.0°
Efficiency 91 %
Peak intensity 0.750 cd/lm
Required components:

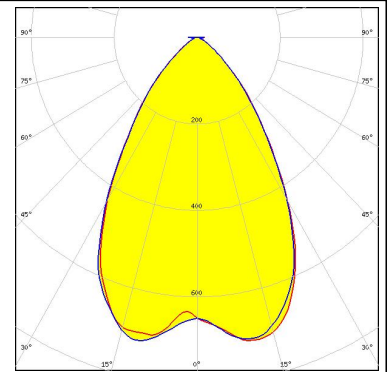

LED XM-L HVW
FWHM 62.0°
Efficiency %
Peak intensity cd/lm
Required components:

GENERAL INFORMATION:

NOTE: The typical beam angle will be changed by different color, chip size and chip position tolerance. The typical total beam angle is the full angle measured where the luminous intensity is half of the peak value.

MATERIALS:

As part of our continuous research and improvement processes, and to ensure the best possible quality and availability of our products, LEDiL reserves the right to change material grades without notice.

PRODUCT DATA USER AGREEMENT AND DISCLAIMER:

The measured data in the provided downloadable LEDiL Product Datasheets and Mechanical 2D-Drawings is rounded and provided as reference for planning. LEDiL Oy's optical specifications have been verified by conducting performance testing of the products in accordance with the company's quality system. The reported data are averaged results of multiple measurements with typical variation. LEDiL Oy reserves the right to without prior notification make changes and improvements to its products.

LEDiL Oy assumes neither warranty, nor guarantee nor any other liability of any kind for the contents and correctness of the provided data. The provided data has been generated with highest diligence but the provided data may in reality not represent the complete possible variation range of all intrinsic parameters. Therefore, in certain cases a deviation from the provided data could occur.

LEDiL Oy reserves the right to undertake technical changes of its products without further notification which could lead to changes in the provided data. LEDiL Oy assumes no liability of any kind for the possible deviation from any provided data or any other damage resulting from the usage of the provided data.

The user agrees to this disclaimer and user agreement with the download or usage of the provided files.

LEDiL Oy

Joensuunkatu 13
FI-24240 SALO
Finland

LEDiL Inc.

228 West Page Street
Suite D
Sycamore IL 60178
USA

Local sales and technical support

[www.ledil.com/
where_to_buy](http://www.ledil.com/where_to_buy)

Shipping locations

Salo, Finland
Hong Kong, China

Distribution Partners

[www.ledil.com/
where_to_buy](http://www.ledil.com/where_to_buy)