

ISL8200MEVAL2PHZ Evaluation Board User's Guide

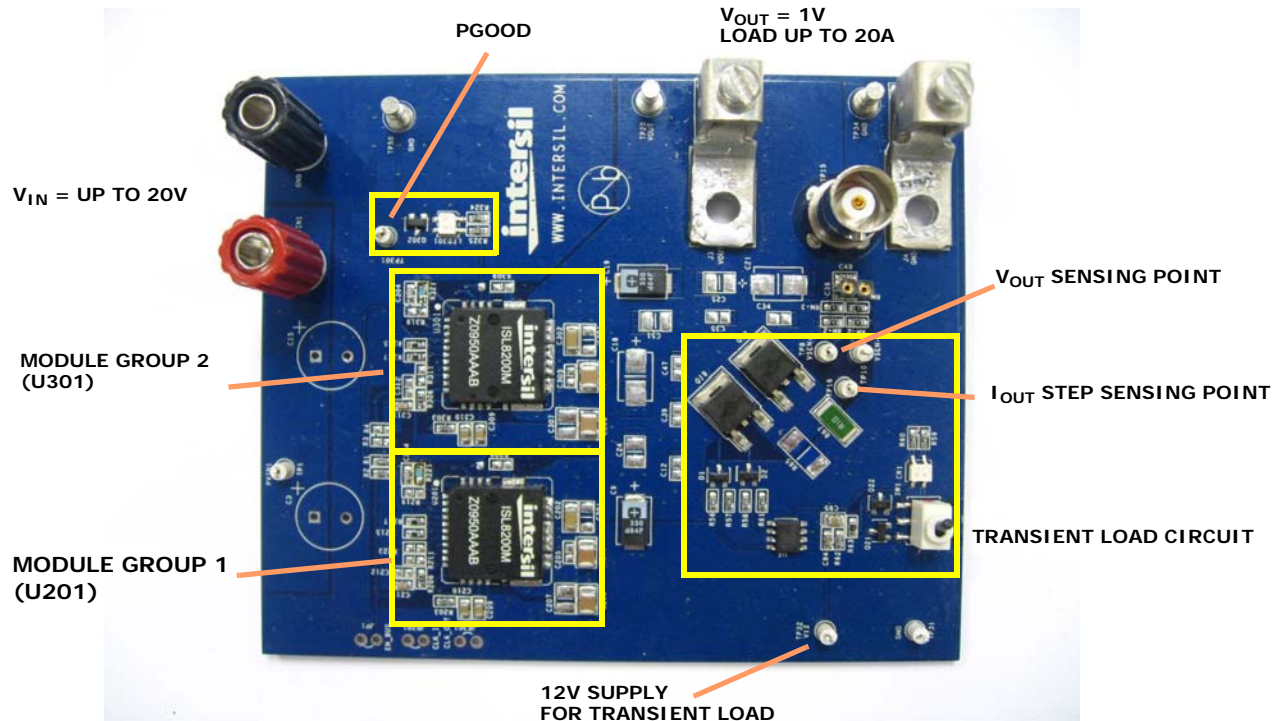

FIGURE 1. ISL8200MEVAL2PHZ EVALUATION BOARD

ISL8200MEVAL2PHZ Evaluation Board

The ISL8200M is a complete 10A step-down current share-able switch mode power module in a low profile package. It can be used in a standalone single-phase operation as well as current shared applications where multiple modules are connected in parallel.

The ISL8200MEVAL2PHZ evaluation board is used to demonstrate performance of the ISL8200M 2-phase current shared application. The input voltage range can be up to 20V, and the output voltage is 1V and 20A maximum load. The output voltage can support a range up to 6V with the proper output capacitor rating.

Recommended Equipment

- 0V to 20V power supply with at least 15A source current capability.
- One Electronic Load capable of sinking current up to 20A.
- Digital multi-meters (DMMs).
- 100MHz quad-trace oscilloscope.
- Signal generator (for synchronization demonstration)

Circuits Description

PVIN1 and GND banana plugs are the input power terminals.

Two input electrolytic caps footprint are provided to handle the input current ripple.

Two SANYO POSCAP 2TPF330M6 (330 μ F, ESR 6m Ω) are used as output E-caps for each channel. Also, cap footprints are available for the user to evaluate different output caps.

J3, J4 are output lugs for load connections.

TP8, TP10 are output voltage sensing points. These pins can be used to monitor and evaluate the system voltage regulations. If the user wants to use these test posts for remote sensing, RM+2, RM-2, RM+3, and RM-3 need to be changed to higher values, such as 10 Ω .

The Transient Load Circuit box shown in Figure 1, contains the circuit option for the on-board transient load control to the power module. Apply 12V supply on TP32 to use the transient load, and switch SW1 toward CR1 LED to enable it. CR1 will be red when the transient load is disabled, and becomes green when it is enabled. The resistors R65 and R67 set the amount of step load with a default value of 10A for 1V output (1V/0.1 Ω). The voltage corresponding to the amount of step load is monitored at TP16.

JP201 is a SIP connector that can be used with R223 = 0Ω installed to inject a clock signal to synchronize the module to. The default phase shift of the CLKOUT signal from module 1 (U201) causes the second to switch with a phase shift of 180°, which can be observed by the relative phase between PHASE2 and PHASE3 signals as shown in Figure 14.

R203, R303 and C210, C310 are small added filters for the VIN pins.

[R233, R234, C208, and Q203] and [R333, R334, C308, and Q303] are used to allow smoother V_{OUT} at start-up.

Quick Start

1. Ensure that the circuit is correctly connected to the supply (PVIN1 and GND banana plugs) and load (J3 and J4) prior to applying any power.
2. Adjust the input supply to be 5V. Turn on the input power supply.
3. Verify the two outputs' voltages are correct. If the PGOOD is set high, LED301 will be green. If the PGOOD is set low, LED301 will be red. TP301 is the test post to monitor PGOOD.

Evaluating Other Output Voltages

The ISL8200MEVAL2PHZ kit outputs are preset to 1.0V/20A. V_{OUT} can also be adjusted between 0.6V to 6V by changing the value of R221 and R321 simultaneously as given by Equation 1.

$$R_{221} = \frac{(V_{OUT} - V_{REF})}{(V_{REF})} ROS \quad \text{where } V_{REF} = 0.6V \quad (EQ. 1)$$

ROS = 2.2k internal

The output capacitors must be changed to support the corresponding output voltage. The onboard output capacitors are rated at 2V max.

Programming the Input Voltage UVLO and its Hysteresis

By programming the voltage divider at the EN pin connected to the input rail, the input UVLO and its hysteresis can be programmed. The ISL8200MEVAL2PHZ has R1 = 8.25k and R2 = 2.05k; the IC will be disabled when the input voltage drops below 4.5V and will restart after V_{IN} recovers to be above 4.0V.

The UVLO equations are re-stated in the following, where R_{UP} and R_{DOWN} are the upper and lower resistors of the voltage divider at EN pin, V_{HYS} is the desired UVLO hysteresis and V_{FTH} is the desired UVLO falling threshold.

$$R_{UP} = \frac{V_{HYS}}{I_{HYS}} \quad \text{where } I_{HYS} = N \times 30\mu A \quad (EQ. 2)$$

N = number of phases (=2)

$$R_{DOWN} = \frac{R_{UP} \cdot V_{ENREF}}{V_{FTH} - V_{ENREF}} \quad \text{where } R_{ENREF} = 0.8V \quad (EQ. 3)$$

For 12V applications, if it is desired to have the IC disabled when the input voltage drops below 9V and restart when V_{IN} recovers above 10.6V, then R1 = 16.5k and R2 = 2.6k.

Efficiency Measurement

Figure 10 shows the efficiency measurement for the ISL8200MEVAL2PHZ Eval Board. The voltage and current meter can be used to measure input/output voltage and current. In order to obtain an accurate measurement and prevent the voltage drop of PCB or wire trace, the voltage meter must be close to the input/output terminals. For simplicity, the measuring point for the input voltage meter is at the TP1 terminal, and the measuring point for the output voltage meter is at the TP20 terminal.

The efficiency equation is shown in Equation 4:

$$\text{Efficiency} = \frac{\text{Output Power}}{\text{Input Power}} = \frac{P_{OUT}}{P_{IN}} = \frac{(V_{OUT} \cdot I_{OUT})}{(V_{IN} \cdot I_{IN})} \quad (EQ. 4)$$

Output Ripple/Noise Measurement

Simple steps should be taken to ensure that there is minimum pickup noise due to high frequency events, which can be magnified by the large ground loop formed by the oscilloscope-probe ground. This means that even a few inches of ground wire on the oscilloscope probe may result in hundreds of millivolts of noise spikes when improperly routed or terminated. This effect can be overcome by using the short loop measurement method to minimize the measurement loop area for reducing the pickup noise. The short loop measurement method is shown in Figure 2. For ISL8200MEVAL2PHZ evaluation board, the output ripple/noise measurement point is located at the C38 terminal.

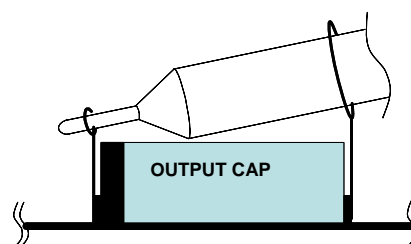

FIGURE 2. OUTPUT RIPPLE/NOISE MEASUREMENT

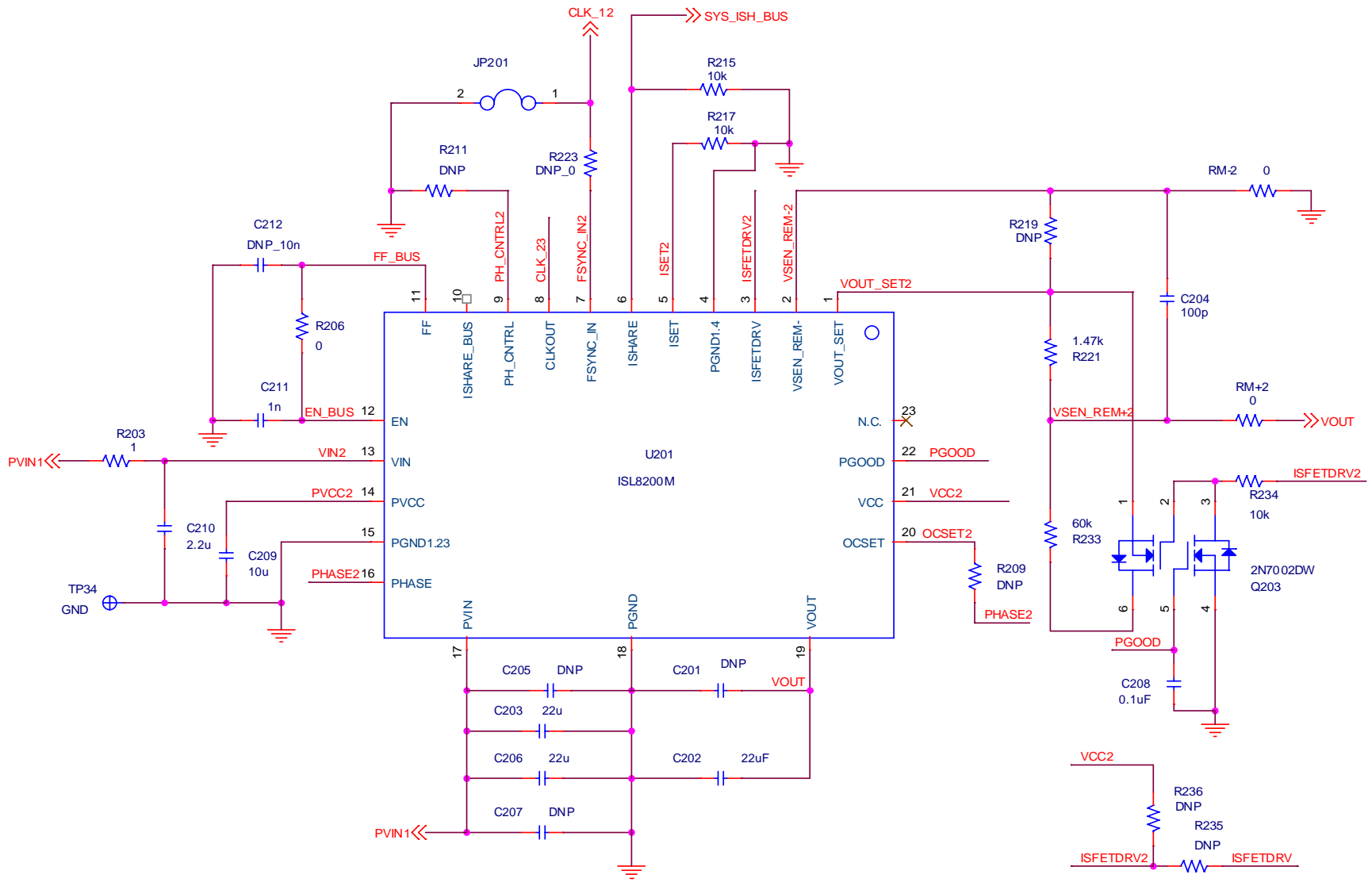

FIGURE 3. SIMPLIFIED SCHEMATIC PER PHASE

ISL8200MEVAL2PHZ Bill of Materials

| REF DES. | PART NUMBER | QTY | MANUFACTURER | DESCRIPTION |
|---|--------------------|-----|---------------------|--|
| C3 | 35ME270AX | 1 | SANYO | CAP, RADIAL, 10X16, 270µF, 35V, 20%, AL.EL., ROHS |
| C204, C304 | ECJ-1VC1H101J | 2 | PANASONIC | CAP, SMD, 0603, 100pF, 50V, 5%, COG, ROHS |
| C211, C311 | GRM188R71H102KA | 2 | MURATA | CAP, SMD, 0603, 1000pF, 50V, 10%, X7R, ROHS |
| C208, C308 | GRM39X7R104K025AD | 2 | MURATA | CAP, SMD, 0603, 0.1µF, 25V, 10%, X7R, ROHS |
| C94 | GRM188R61E105KA12D | 1 | MURATA | CAP, SMD, 0603, 1µF, 25V, 10%, X5R, ROHS |
| C38 | C0805C105K4RACTU | 2 | KEMET | CAP, SMD, 0805, 1µF, 16V, 10%, X7R, ROHS |
| C209, C309 | C0805X5R160-106KNE | 2 | VENKEL | CAP, SMD, 0805, 10µF, 16V, 10%, X5R, ROHS |
| C95, C210, C310 | ECJ-2FB1E225K | 3 | PANASONIC | CAP, SMD, 0805, 2.2µF, 25V, 10%, X5R, ROHS |
| C202, C302 | C1206X5R160-226KNE | 2 | VENKEL | CAP, SMD, 1206, 22µF, 16V, 10%, X5R, ROHS |
| C203, C206, C303, C306 | GRM32ER61E226KE15L | 4 | MURATA | CAP, SMD, 1210, 22µF, 25V, 10%, X5R, ROHS |
| C9, C19 | 2TPF330M6 | 2 | SANYO | CAP, POSCAP, SMD, 7.3X4.3X1.8, 330µF, 2V, 20%, 6mΩ, ROHS |
| PVIN1 | 111-0702-001 | 1 | JOHNSON COMPONENTS | CONN-GEN, BIND.POST, INSUL-RED, THMBNUT-GND |
| GND | 111-0703-001 | 1 | JOHNSON COMPONENTS | CONN-GEN, BIND.POST, INSUL-BLK, THMBNUT-GND |
| TP20, TP34, TP50 | 1514-2 | 3 | KEYSTONE | CONN-TURRET, TERMINAL POST, TH, ROHS |
| TP15 | 31-5329-52RFX | 1 | AMPHENOL | CONN-BNC, RECEPTACLE, TH, 4 POST, 50Ω, GOLDCONTACT, ROHS |
| TP1, TP8, TP10, TP16, TP31, TP32, TP301 | 5002 | 6 | KEYSTONE | CONN-MINI TEST POINT, VERTICAL, WHITE, ROHS |
| D1, D2 | BAV99LT1G | 2 | ON SEMICONDUCTOR | DIODE-SWITCHING, SMD, SOT23, 70V, 0.2A, ROHS |
| CR1, LED301 | SSL-LXA30251GC-TR | 2 | LUMEX | LED, SMD, 3x2.5mm, 4P, RED/GREEN, 12/20MCD, 2V |
| U6 | HIP2100IBZ | 1 | INTERSIL | IC-HI FREQ BRIDGE DRIVER, 8P, SOIC, 100V, ROHS |
| U201, U301 | ISL8200MIRZ | 2 | INTERSIL | IC-10A DC/DC PWR SUPPLY MODULE, 23P, QFN, 15X15, ROHS |
| Q21, Q22, Q302 | 2N7002-7-F | 3 | DIODES, INC. | TRANSISTOR, N-CHANNEL, 3LD, SOT-23, 60V, 115mA, ROHS |
| Q203, Q303 | 2N7002DW | 2 | INFINEON TECHNOLOGY | TRANSIST-MOS, DUAL N-CHANNEL, SMD, 6P, SOT363, 60V, 0.3A, ROHS |
| Q17, Q19 | SUD50N03-06AP-E3 | 2 | VISHAY | TRANSISTOR-MOS, N-CHANNEL, SMD, TO-252, 30V, 90A, ROHS |
| R203, R303 | ERJ-3RQF1R0V | 2 | PANASONIC | RES, SMD, 0603, 1Ω, 1/10W, 1%, TF, ROHS |

Application Note 1544

ISL8200MEVAL2PHZ Bill of Materials (Continued)

| REF DES. | PART NUMBER | QTY | MANUFACTURER | DESCRIPTION |
|--|-------------------|-----|-----------------------------|---|
| R206, R306, RM+2, RM-2, RM+3, RM-3 | CR0603-10W-000T | 6 | VENKEL | RES, SMD, 0603, 0Ω, 1/10W, TF, ROHS |
| R215, R217, R234, R315, R317, R334 | RK73H1JT1002F | 6 | KOA | RES, SMD, 0603, 10k, 1/10W, 1%, TF, ROHS |
| R62 | | 1 | PANASONIC | RES, SMD, 0603, 100k, 1/10W, 1%, TF, ROHS |
| R2 | CR0603-10W-2051FT | 1 | VENKEL | RES, SMD, 0603, 2.05k, 1/10W, 1%, TF, ROHS |
| R59, R60, R324, R325 | RC0603FR-073K32L | 4 | YAGEO | RES, SMD, 0603, 3.32k, 1/10W, 1%, TF, ROHS |
| R57, R61 | CR0603-10W-4020FT | 2 | VENKEL | RES, SMD, 0603, 402Ω, 1/10W, 1%, TF, ROHS |
| R221, R321 | ERJ-3EKF1471V | 2 | PANASONIC | RES, SMD, 0603, 1.47k, 1/10W, 1%, TF, ROHS |
| R63 | CR0603-10W-5101FT | 1 | VENKEL | RES, SMD, 0603, 5.1k, 1/10W, 1%, TF, ROHS |
| R233, R333 | RC0603FR-0760K4L | 2 | YAGEO | RES, SMD, 0603, 60.4k, 1/10W, 1%, TF, ROHS |
| R56, R58 | MCR03EZPFX8060 | 2 | ROHM | RES, SMD, 0603, 806Ω, 1/10W, 1%, TF, ROHS |
| R1 | ERJ-3EKF8251V | 1 | PANASONIC | RES, SMD, 0603, 8.25KΩ, 1/10W, 1%, TF, ROHS |
| R65, R67 | WSL-2512-R100F | 2 | DALE | RES, SMD, 2512, 0.1W, 1W, 1%, TF, ROHS |
| SW1 | GT11MSCBE | 1 | ITT INDUSTRIES/C&K DIVISION | SWITCH-TOGGLE, SMD, 6PIN, SPDT, 2POS, ON-ON, ROHS |
| J3, J4 | KPA8CTP | 2 | BERG/FCI | HDWARE, MTG, CABLE TERMINAL, 6-14AWG, LUG&SCREW, ROHS |
| Bottom four corners | SJ-5003SPBL | 4 | 3M | BUMPONS, 0.44inWx0.20inH, DOMETOP, BLACK |
| JP1, JP201, JP301 | | 0 | | DO NOT POPULATE OR PURCHASE |
| a) C12, C15, C18, C21, C24, C25, C34, C35, C49 | | 0 | | DO NOT POPULATE OR PURCHASE |
| a) R3, R4, R209, R211, R219, R223, R235, R236 | | 0 | | DO NOT POPULATE OR PURCHASE |
| b) C39, C47, C51, C201, C205, C207, C212 | | 0 | | DO NOT POPULATE OR PURCHASE |
| b) R309, R311, R319, R335, R336 | | 0 | | DO NOT POPULATE OR PURCHASE |
| c) C301, C305, C307, C312 | | 0 | | DO NOT POPULATE OR PURCHASE |

ISL8200MEVAL2PHZ Board Layout

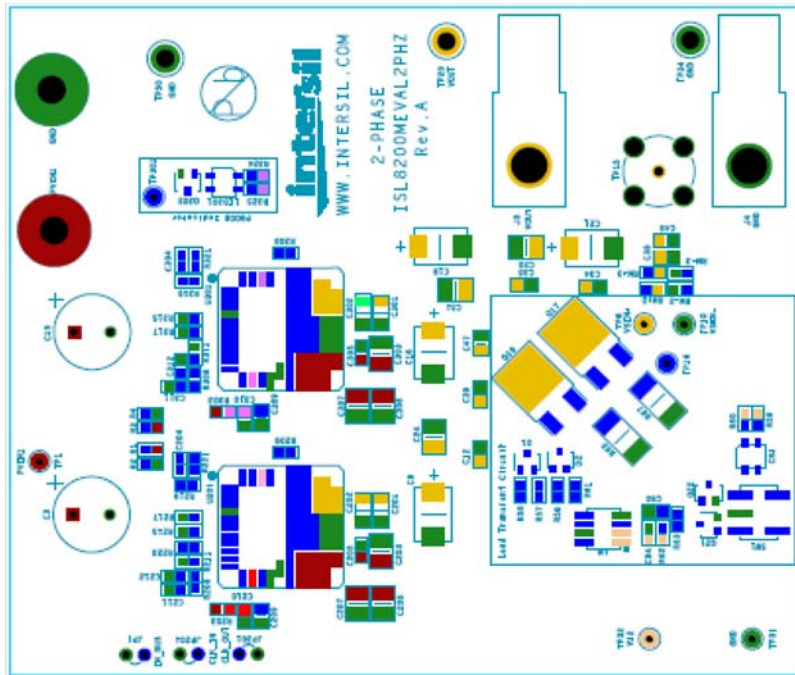

FIGURE 4. TOP COMPONENTS

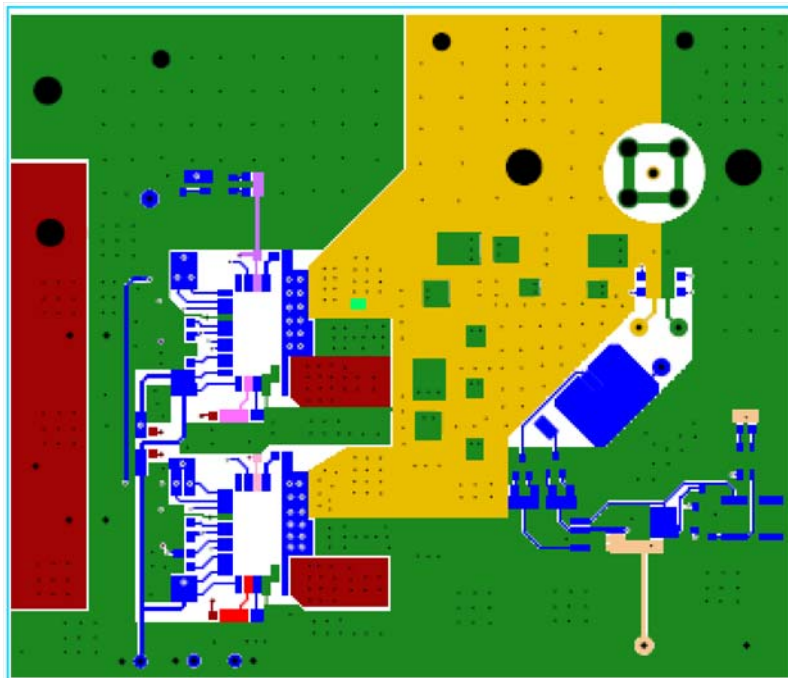

FIGURE 5. TOP LAYER

ISL8200MEVAL2PHZ Board Layout (Continued)

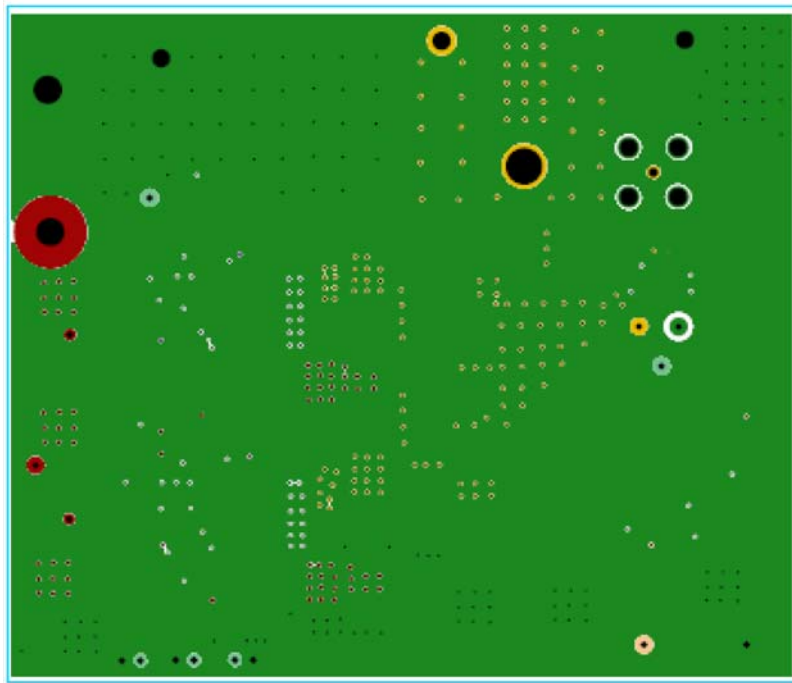

FIGURE 6. 2nd LAYER

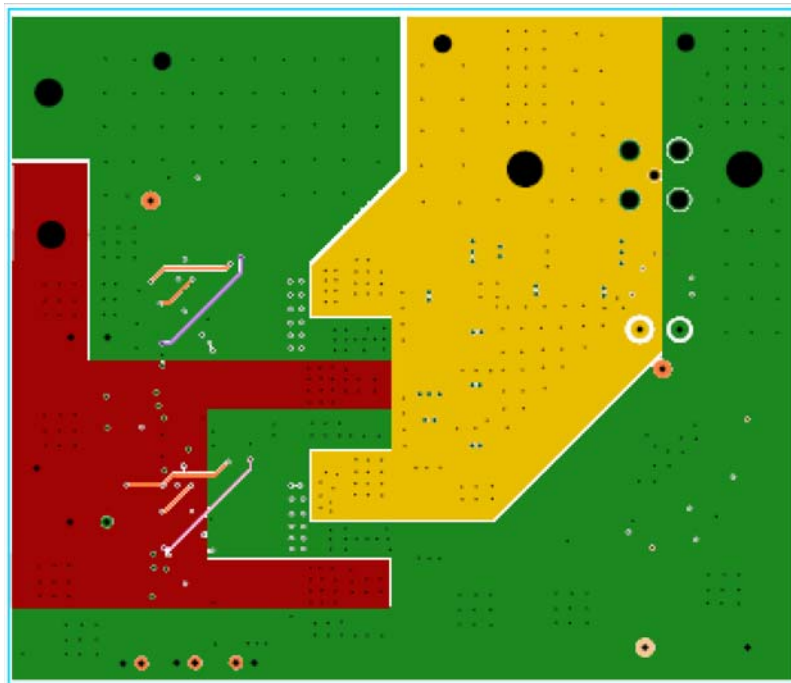

FIGURE 7. 3rd LAYER

ISL8200MEVAL2PHZ Board Layout (Continued)

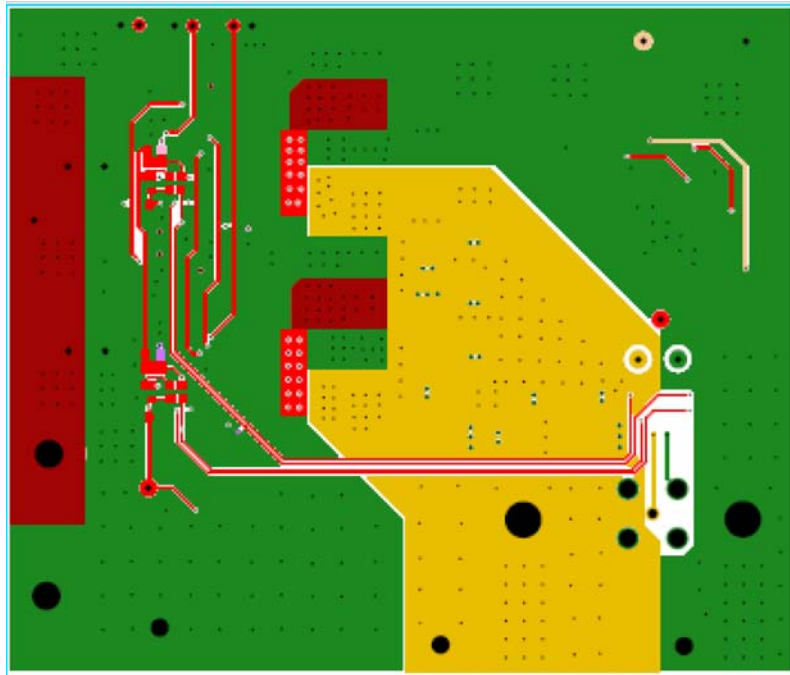

FIGURE 8. BOTTOM LAYER (MIRRORED)

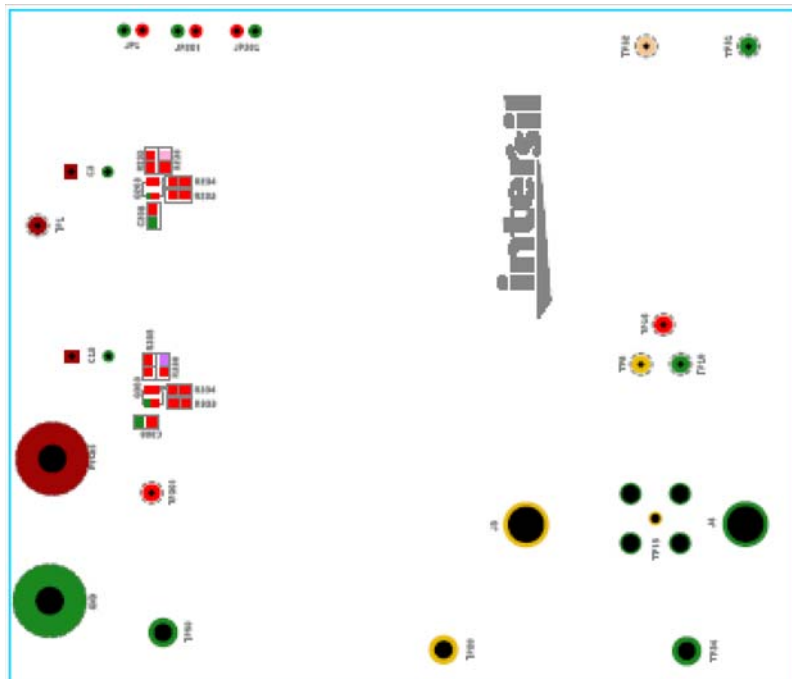

FIGURE 9. BOTTOM COMPONENTS (MIRRORED)

Test Data for ISL8200MEVAL2PHZ

Efficiency

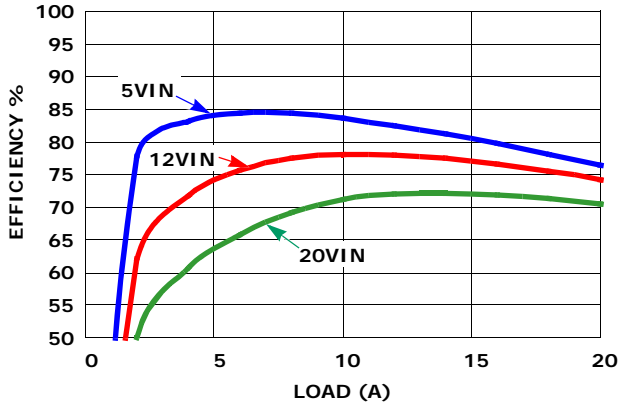

FIGURE 10. EFFICIENCY (5, 12, 20V_{IN} AND 1.0V V_{OUT})

Load Regulation

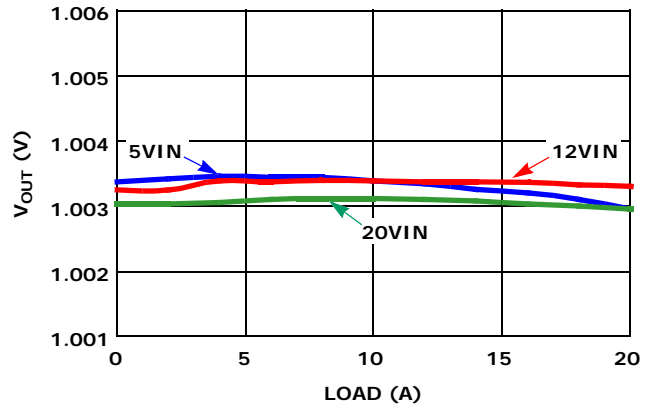

FIGURE 11. LOAD REGULATION (5, 12, 20V_{IN})

Start-up

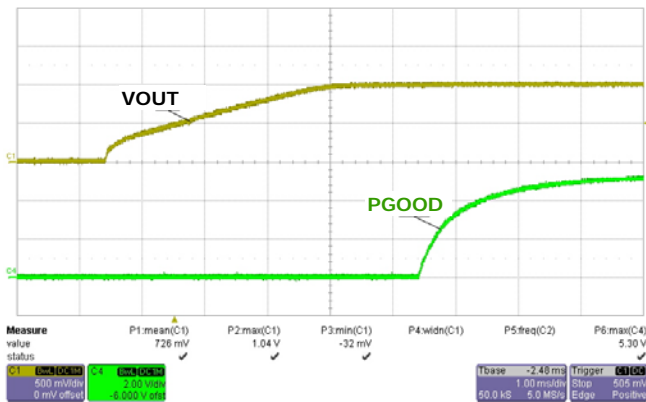

FIGURE 12. START-UP UNDER NO LOAD, P_{VIN} = V_{IN} = 12V, I_{OUT} = 0A

Output Ripple

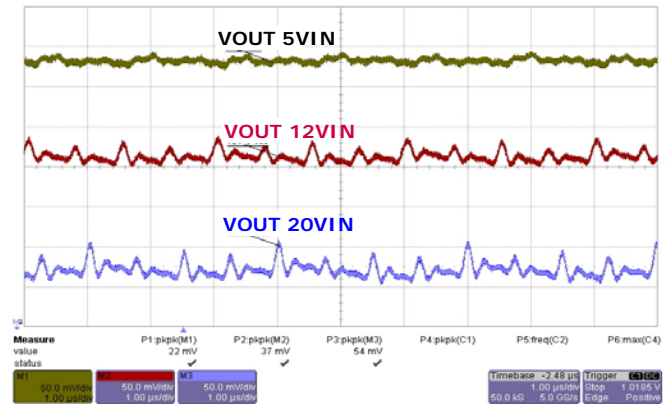

FIGURE 13. OUTPUT RIPPLE UNDER 20A FOR P_{VIN} = V_{IN} = 5, 12, 20V

Phases and V_{OUT}

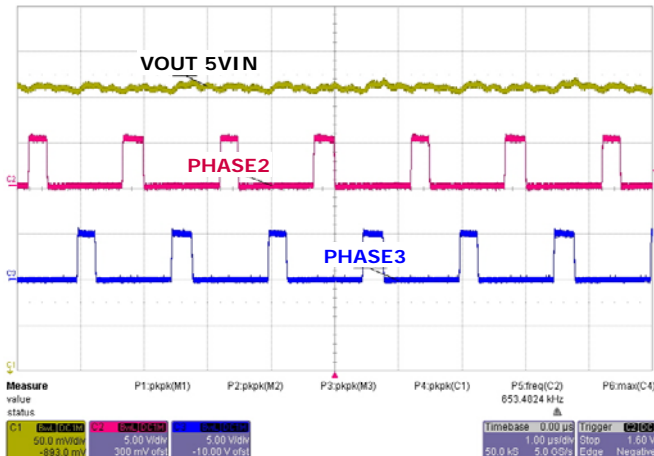

FIGURE 14. PHASE AND V_{OUT} FOR P_{VIN} = V_{IN} = 5V

Load Transient

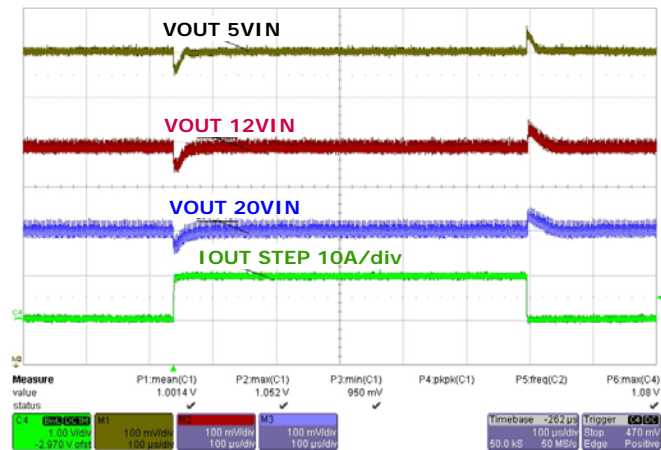

FIGURE 15. LOAD TRANSIENT (0A TO 10A STEP, SLEW RATE = 10A/μs) FOR INPUT = 5, 12, 20V

Intersil Corporation reserves the right to make changes in circuit design, software and/or specifications at any time without notice. Accordingly, the reader is cautioned to verify that the Application Note or Technical Brief is current before proceeding.

For information regarding Intersil Corporation and its products, see www.intersil.com