

Assembly Instructions for - 37220

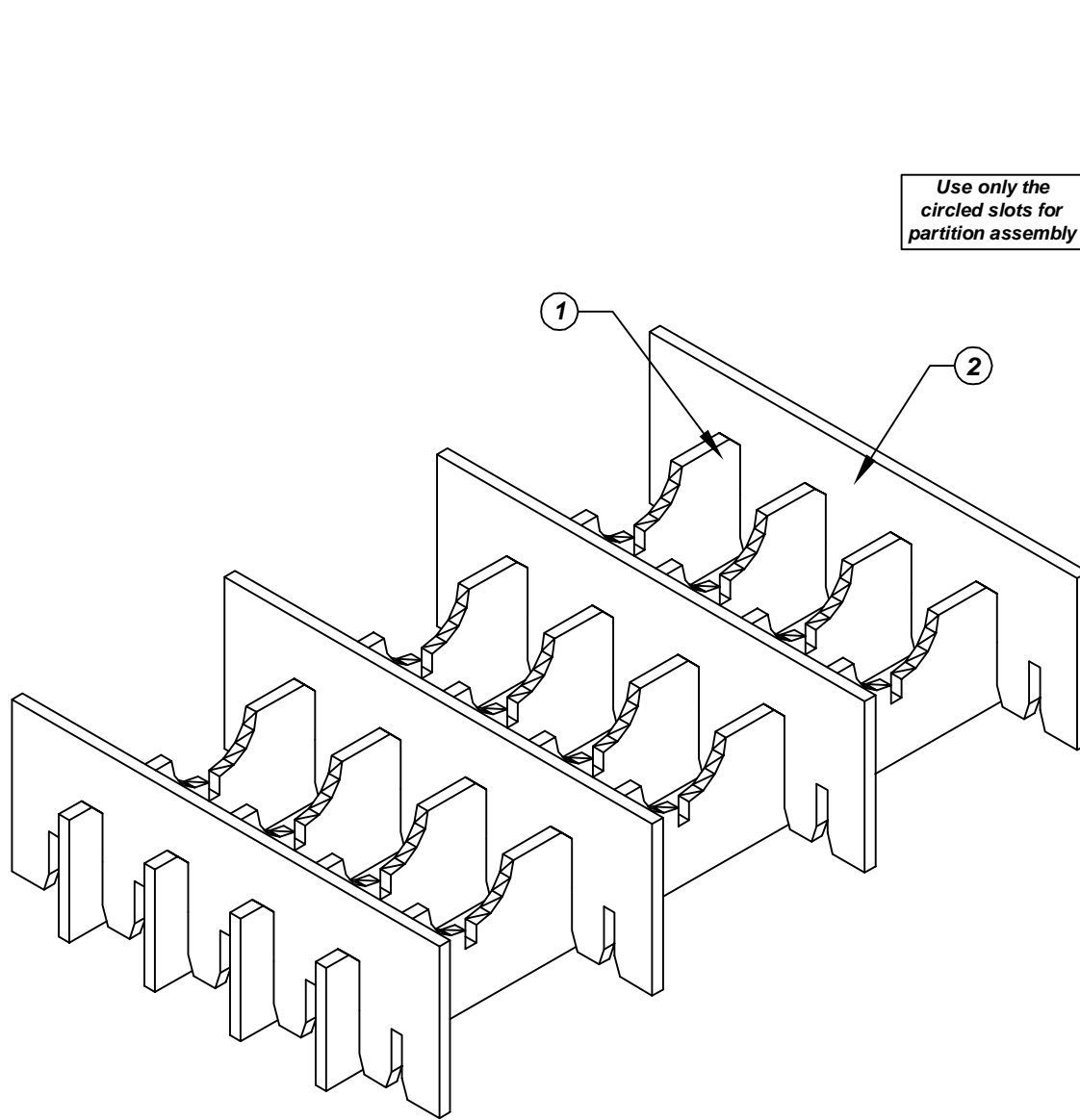

Use only the circled slots for partition assembly

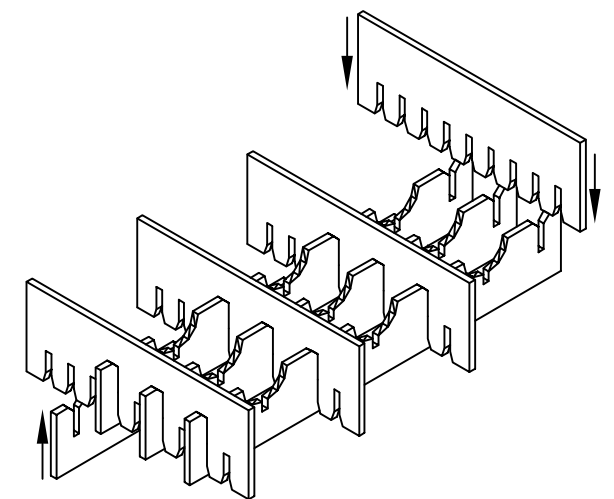
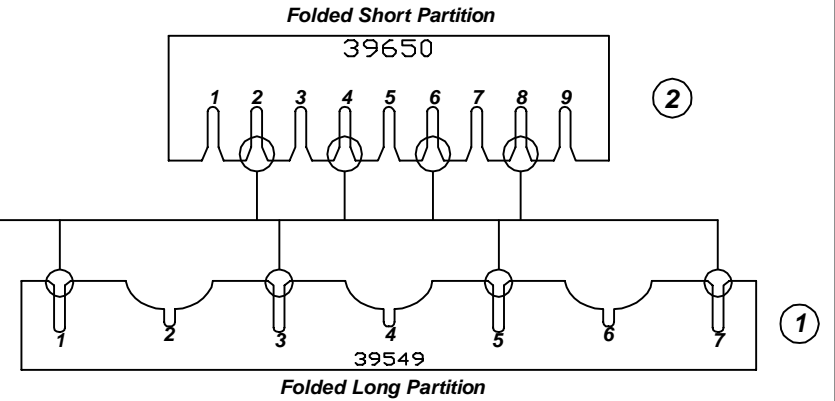

Made in America

F/N ①	Part # 39549	Dimensions: 5-3/16" x 16-13/16"	Description: 411/422-LP Long Partition	Qty: 4
F/N ②	Part # 39650	Dimensions: 7-3/16" x 10"	Description: 411-SP Short Partition	Qty: 4

37220 - 15 Cell Inplant Handler Cell Size - 3-1/2" x 4-3/4" x 1-3/4"

Notes:
For use with the following storage container & lid:
37508 - Storage Container
37550 - Lid

PROTEKTIVE PAK
13520 MONTE VISTA AVENUE, CHINO, CA 91710
PHONE (909) 627-2578, FAX (909) 363-7331
ProtectivePak.com



DRAWING NUMBER
IPH-37220

DATE
Nov.
2007