

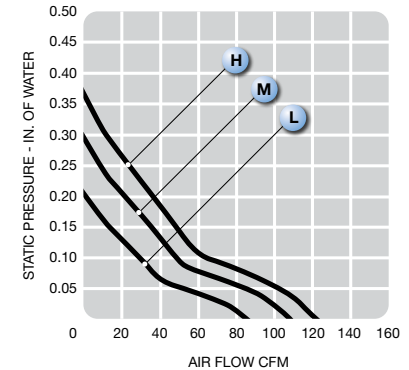

LPH12A99 series

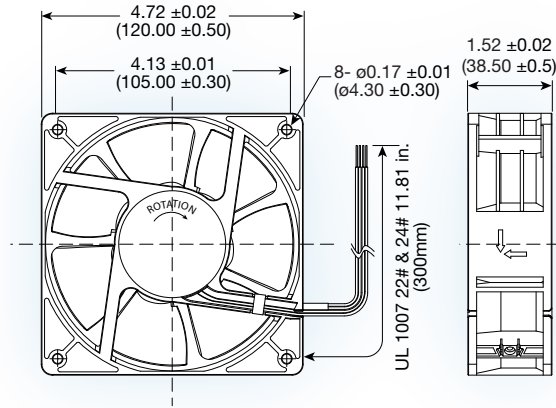

(120 x 120 x 38 mm)

4.72 x 4.72 x 1.52 inches

Operating voltage: 100 to 240 VAC

Construction: plastic frame and impeller

Bearing option: ball bearing

Motor: electronically commutated

Air flow: exhaust over struts

Connection: lead wire UL1007 24AWG
or terminal

Protection: auto restart

Options: tachometer, PWM,
environmental protection

Model No.	Rated Voltage V	Freq. HZ	Input Power W	Rated Cur. A	Speed RPM	Air Volume		Max. Static Pressure (H ₂ O)		Sound Noise dB A	Weight g
						M ³ /Min.	CFM	MM	INCH		
LPH12A99-L	100-240	50/60	4.2	0.08	2500	2.4	86	5.1	0.20	39	285
LPH12A99-M	100-240	50/60	6.2	0.12	3000	3.1	110	7.4	0.29	45	285
LPH12A99-H	100-240	50/60	9.5	0.18	3500	3.5	124	9.1	0.36	49	285