

MODEL:

# PDUMNV30

## Monitored Rackmount PDU



**Low Voltage  
Input/Output**



**24 Outlets**



**30A Max Capacity**



**Multimode  
Load Meter**

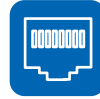

**Network  
Interface**



**0U Rackmount**



**Toolless  
Mounting  
Buttons**

- A** Digital Load Meter
- B** 5-15/20R Outlets
- C** 20A Circuit Breakers
- D** Removable Cord Retention Brackets
- E** Removable Mounting Brackets
- F** Toolless Mounting Buttons with Removable 90° Rotation Brackets
- G** 10 ft. Input Power Cord
- H** L5-30P Twist-Lock Input Plug
- I** Durable Metal Case
- J** Network Interface
- K** RJ45 Ethernet Jack
- L** Manual Configuration Port
- M** Environmental Monitoring Port
- N** Network Interface Reset Button

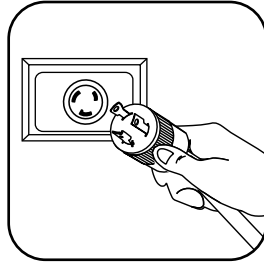

AC Input Connection: Insert L5-30P twist-lock plug into compatible L5-30R utility, generator or UPS outlet.

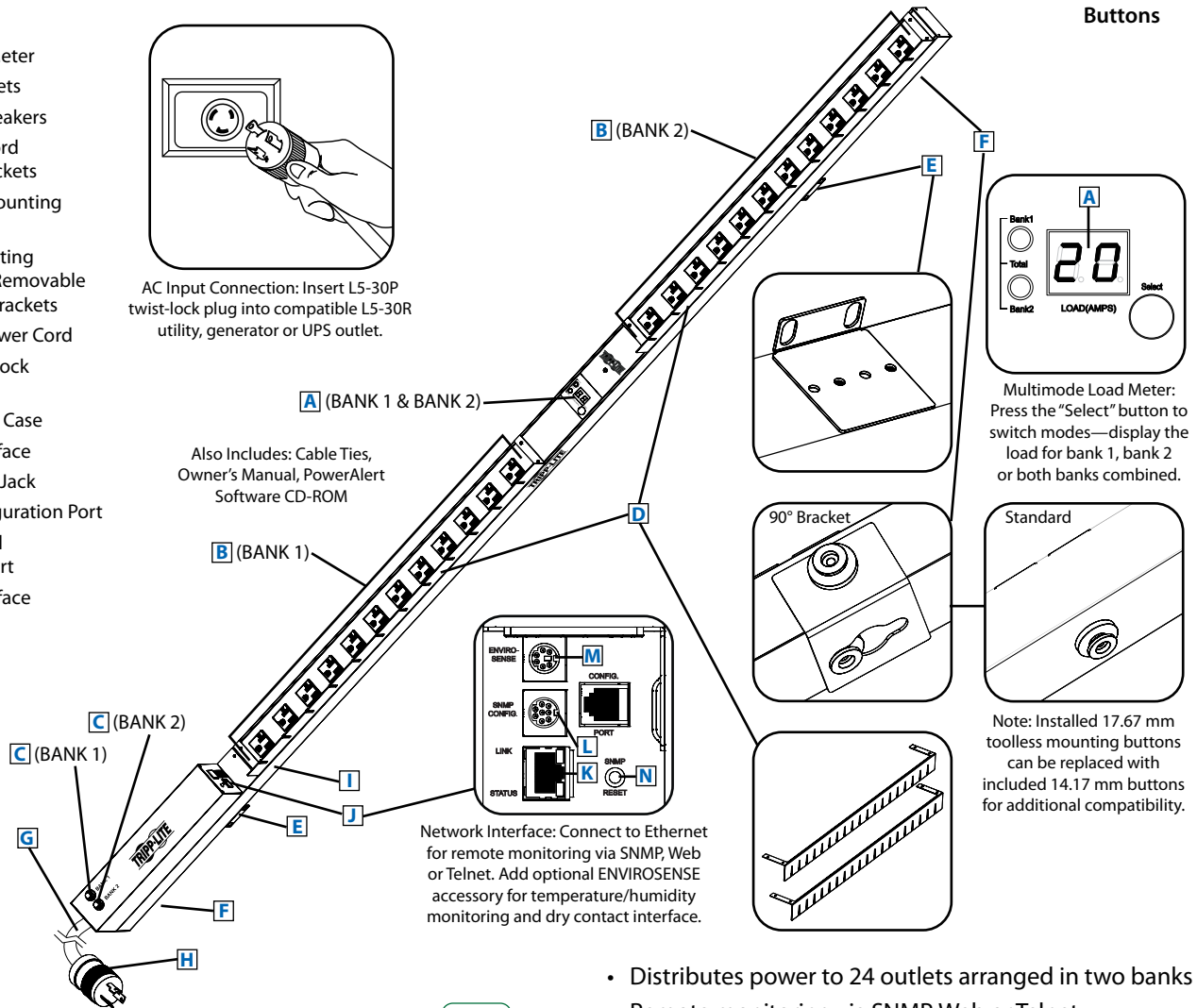

Also Includes: Cable Ties, Owner's Manual, PowerAlert Software CD-ROM

Network Interface: Connect to Ethernet for remote monitoring via SNMP, Web or Telnet. Add optional ENVIROSENSE accessory for temperature/humidity monitoring and dry contact interface.

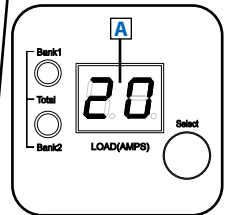

Multimode Load Meter: Press the "Select" button to switch modes—display the load for bank 1, bank 2 or both banks combined.

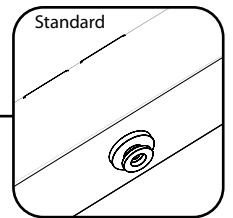
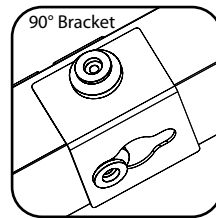
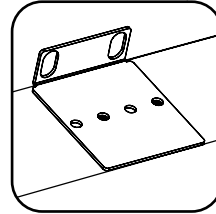

Note: Installed 17.67 mm toolless mounting buttons can be replaced with included 14.17 mm buttons for additional compatibility.

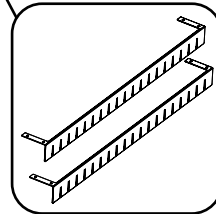

### Specifications

Model	PDUMNV30
Voltage	100-127V
Frequency	50/60Hz
Maximum Capacity	30A
Agency-Derated Capacity	24A
Input Connector	L5-30P
Cord Length	10 ft.
Outlets	24 (5-15/20R)
Primary Mounting Option	0U (Vertical) Rackmount
Unit Weight & Dimensions	11.5 lb / 4.25 x 70 x 2.25 in. <i>See next page for detailed unit measurements.</i>
Certifications	Tested to UL 60950-1 (US & Canada), NOM (Mexico), FCC Class A

Tripp Lite has a policy of continuous improvement. Specifications are subject to change without notice.



- Distributes power to 24 outlets arranged in two banks
- Remote monitoring via SNMP, Web or Telnet
- Displays load for either outlet bank or both banks combined in real time
- Perfect for rackmount server, network and telecom applications

**SEE NEXT PAGE FOR DETAILED UNIT MEASUREMENTS**



1111 W. 35th Street  
Chicago, IL 60609 USA  
773.869.1234  
www.tripplite.com

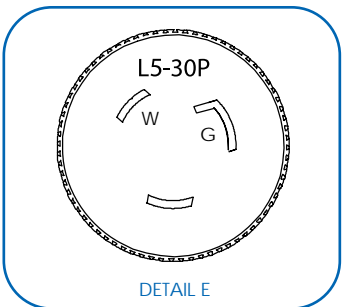
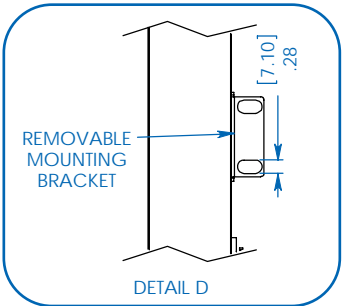
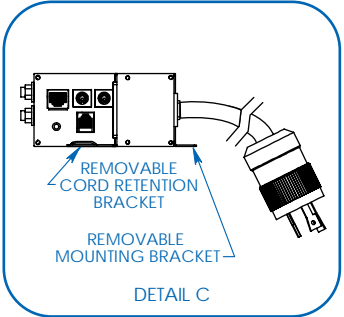
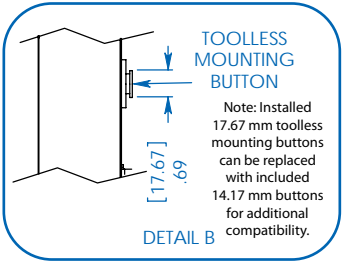
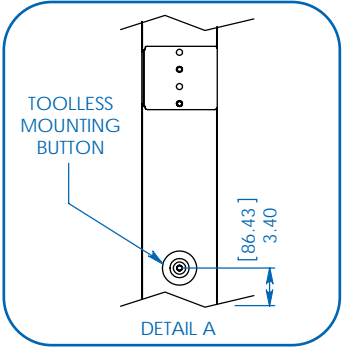
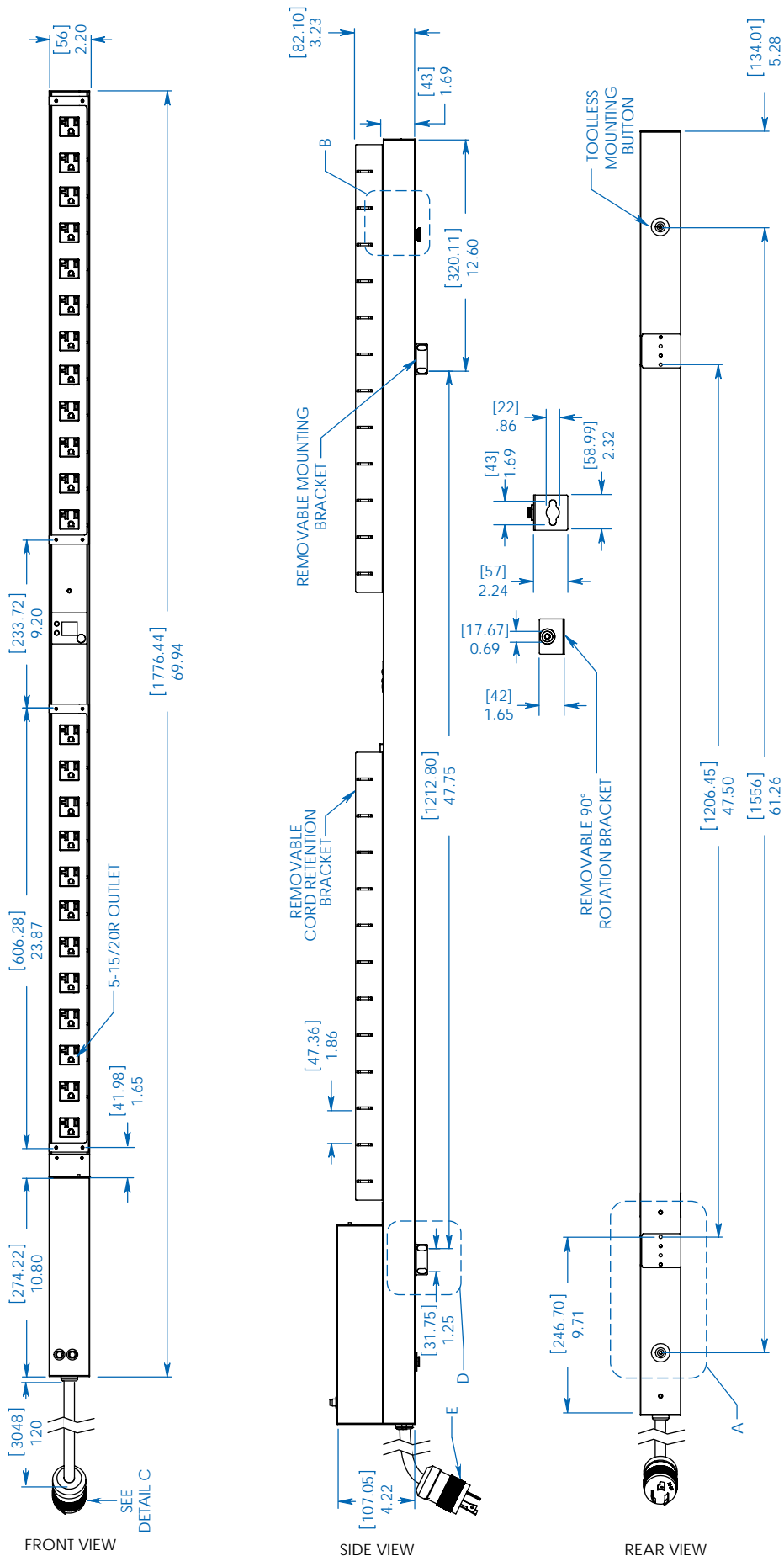

Dimensions: [mm] INCHES

Tripp Lite has a policy of continuous improvement. Specifications are subject to change without notice.

MODEL:  
**PDUMNV30**

**TRIPP-LITE**

1111 W. 35th Street  
Chicago, IL 60609 USA  
773.869.1234  
www.triplite.com