

---

## **USER GUIDE FOR IR3651 EVALUATION BOARD**

### **DESCRIPTION**

The IR3651 is a high voltage PWM controller designed for high performance synchronous Buck DC/DC applications. The IR3651 drives a pair of external N-MOSFETS using a programmable switching frequency up to 400kHz allows flexibility to tune the operation of the IC to meet system level requirements, and synchronization allows the simplification of system level filter design. The output voltage can be precisely regulated using the internal 1.25V reference voltage for low voltage applications. Protection functions such as under voltage lockout and hiccup current limit are provided to give required system level security in the event of fault conditions.

This user guide contains the schematic and bill of materials for the IR3651 evaluation board. The guide describes operation and use of the evaluation board itself. Detailed application information for the IR3651 integrated circuit is available in the IR3651 data sheet.

### **Evaluation Board Specifications:**

$$V_{IN} = 48V, \text{ tolerance } 10\%$$

$$V_{OUT} = 3.3V \text{ at } 10A$$

$$F_S = 100kHz$$

---

### **CONNECTIONS**

**J2:  $V_{IN} = 48V$**

**J3:  $V_{OUT} = 3.3V$**

**J4, J7: GROUND**

**J5: Shutdown control input**

**J6: Sync input**

**J1: External 12V supply option.**

**CONNECTION DIAGRAM**

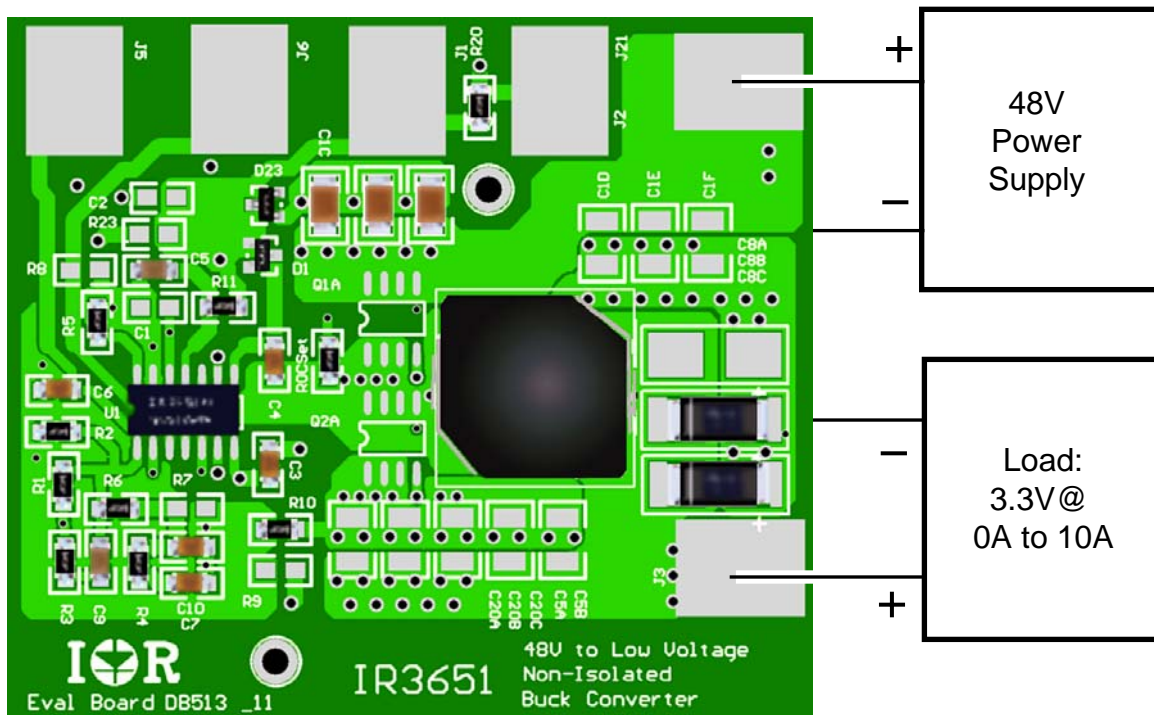

**Note:** Ground connection pads are located on the bottom side of the circuit board.

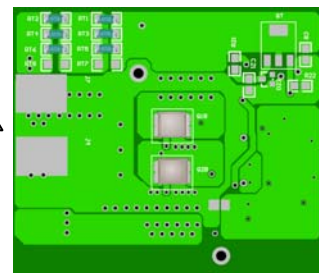
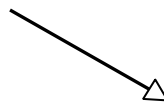

**Figure 1 – Connections to IR3651 evaluation board for default configuration .**

**CIRCUIT LAYOUT - TOP LAYER**

The PCB is a 4-layer FR4 board. The IR3651 IC and the associated passive components are mounted on the top side of the board.

Solder pads for off-board connections to various power supply options and control signals are placed on the top layer.

Off-board connections to ground are available on the bottom layer.

Power supply decoupling capacitors, the charge pump capacitor and feedback components are located close to the IR3651 IC. The feedback resistors are connected to the output voltage at the point of regulation and are located close to the IC.

Two alternatives are provided for implementation of the required single point of connection between Signal Ground and Power ground. Install a zero ohm resistor at location R10 to implement the shortest available connection between the grounds. Installation of R10 is the minimum-noise solution and is the default. If R10 is removed and R9 is installed, an approximation of remote voltage sensing is available. Remote sensing will minimize voltage error due to ground currents, but may be more vulnerable to high-frequency noise.

Two different MOSFET configurations can be used: eight-pin SOIC packages on the top side of the board or MX-packaged DirectFets on the bottom side of the board. The bottom-side location of the DirectFet packages allows convenient mounting of heat sinking devices

The input and output energy storage capacitors and the power inductor are placed close to the MOSFET packages.

To improve efficiency, the circuit board is designed to minimize the length of the on-board power ground current path.

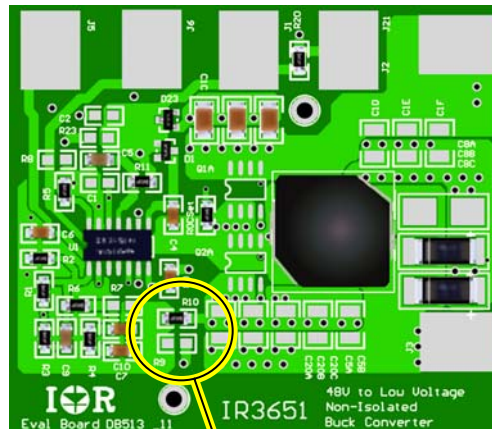

Either R9 or R10 (default) must be installed to implement the required single point of connection between Signal Ground and Power Ground.

**Figure 2 – Top layer of the IR3651 evaluation board.**

**CIRCUIT LAYOUT- BOTTOM LAYER**

Solder pads for off-board connections ground are available on the bottom layer. A portion of the bottom layer plane is isolated for use as Signal Ground. Options for making the required single point of connection between Signal ground and Power Ground are provided on the top side of the board.

MX-packaged DirectFets can be mounted on the bottom side of the board. The bottom-side location of the DirectFet packages allows convenient attachment of a heat sink.

The IR3651 controller requires a low voltage power source (nominally 12V). Elements of a simple linear voltage regulator are installed on a circuit pattern provided on the bottom layer to generate the required voltage from the 48V input supply.

Alternatively, a separate external 12V supply can be connected at J12, on the top side of the board.

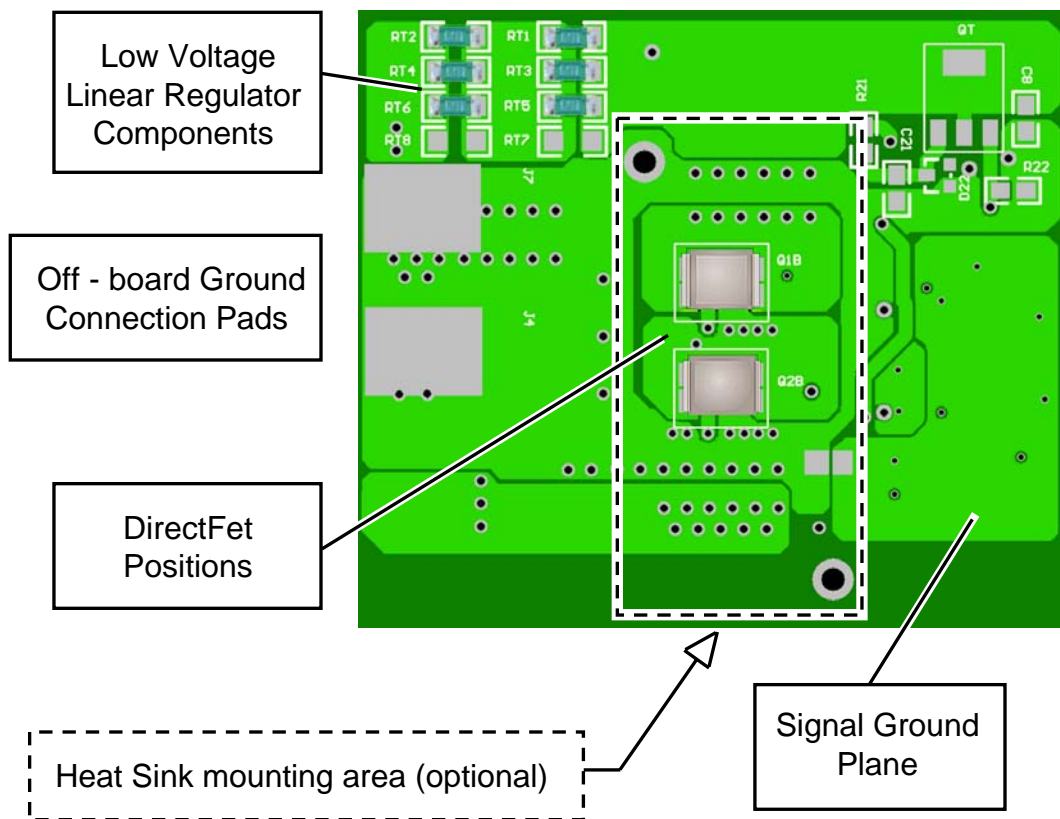

**Figure 3 – Bottom layer of the IR3651 evaluation board.**

**LAYOUT -- MID-LAYERS**

The two mid-layers are used primarily for Power Ground.

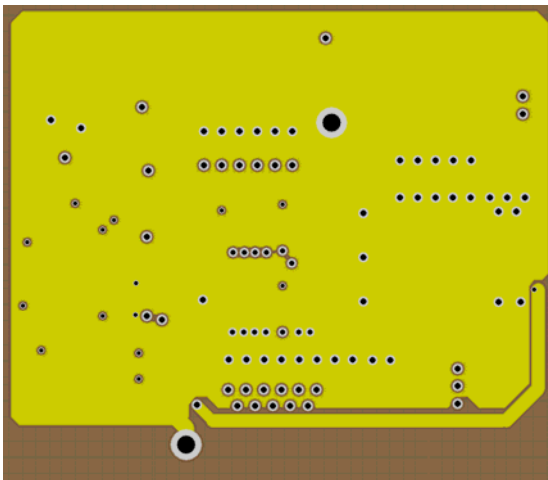

Mid-layer 1

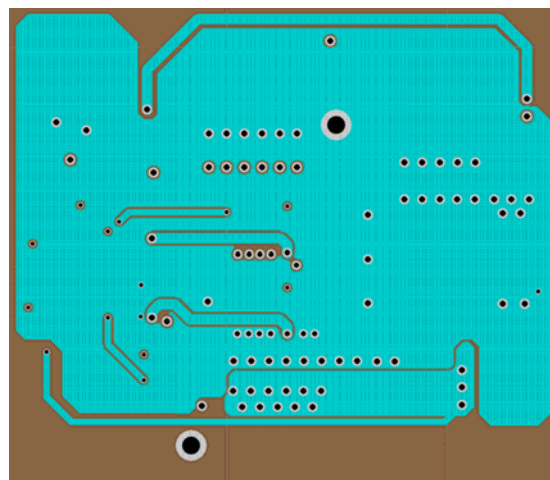

Mid-layer 2

**Figure 3 – Internal layers of IR3651 evaluation board.**

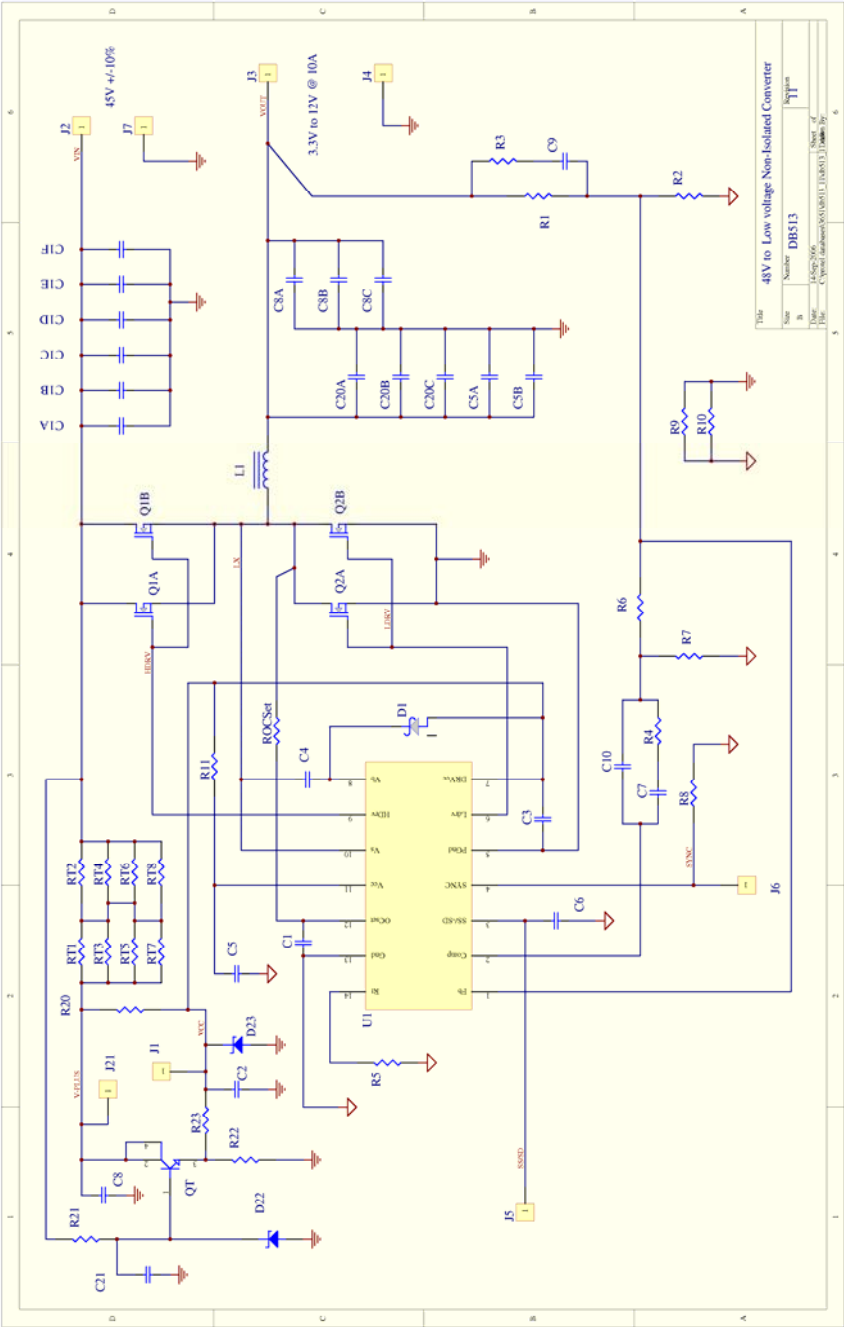

**Figure 4 – Schematic of the IR3651 evaluation board**

**BILL OF MATERIALS**

Quantity	Designator	Value 1	Value 2	Tolerance	Description 1	Description 2	Package	Source	Source Part No.
1	U1	*	*	*	IC	PWM Controller	SOIC-14	IR	IR3651
1	Q1B	*	*	*	MOSFET	POWER NFET	DirectFET	IR	IRF662
1	Q2B	*	*	*	MOSFET	POWER NFET	DirectFET	IR	IRF6646
1	D1	*	*	*	DIODE	Silicon PN	SOT-23	ON	MMBD6100LT1
1	D23	12V	230mW	*	Zener Diode	*	SOT-23	Diodes Inc.	BZX84C12-7-F
1	ROCS <sub>et</sub>	19.1k	1/8W	1%	RESISTOR	thick film	0805	Panasonic-ECG	ERJ-6ENF1912V
6	RT1, RT2, RT3, RT4, RT5, RT6	2.43k	1/4W	1%	RESISTOR	thick film	1206	Panasonic-ECG	ERJ-8ENF2431V
3	R6, 10, 20	0 Ohm	1/8W	1%	RESISTOR	thick film	0805	Panasonic-ECG	ERJ-6ENF0R00V
1	R11	665 Ohm	1/8W	1%	RESISTOR	thick film	0805	Panasonic-ECG	ERJ-6ENF6650V
1	R3	1.5k	1/8W	1%	RESISTOR	thick film	0805	Panasonic-ECG	ERJ-6ENF1501V
1	R4	4.99k	1/8W	1%	RESISTOR	thick film	0805	Panasonic-ECG	ERJ-6ENF4991V
1	R2	17.4k	1/8W	1%	RESISTOR	thick film	0805	Panasonic-ECG	ERJ-6ENF1742V
1	R1	28.7k	1/8W	1%	RESISTOR	thick film	0805	Panasonic-ECG	ERJ-6ENF2872V
1	R5	255k	1/8W	1%	RESISTOR	thick film	0805	Panasonic-ECG	ERJ-6ENF2553V
1	C10	220pF	50V	5%	CAPACITOR	C0G (NP0)	0805	KEMET	C0805C221J5GACTU
1	C9	2.2nF	50V	5%	CAPACITOR	C0G (NP0)	0805	MURATA	GRM2165C1H222JA01D
1	C7	18nF	50V	5%	CAPACITOR	C0G (NP0)	0805	MURATA	GRM21B5C1H183JA01L
2	C4, 6	0.1uF	25V	10%	CAPACITOR	X7R	0805	YAEGO	CC0805KRX7R8BB104
2	C3, 5	1uF	16V	10%	CAPACITOR	X5R	0805	Panasonic-ECG	ECJ-2FB1C105K
3	C1A, C1B, C1C	2.2uF	100V	*	CAPACITOR	X7R	1210	MURATA	GRM32ER72A225K
2	C8A, C8B	330uF	6V	*	CAPACITOR	POSCAP	*	SANYO	6TPD330M
1	L1	6.8uH	*	*	INDUCTOR	*	0.5 x 0.5	ACT	STS1305-6R8M
1	Circuit board	*	*	*	PCB	Rev_11	*	IR	DB513
5	R7, 8, 9, 21, 22, 23	UNUSED	*	*	*	*	0805	*	*
2	RT7, RT8	UNUSED	*	*	*	*	1206	*	*
4	C1, 2, 8, 21	UNUSED	*	*	*	*	0805	*	*
3	C1D, C1E, C1F	UNUSED	*	*	*	*	1210	*	*
1	C8C	UNUSED	*	*	*	*	*	*	*
5	C5A, C5B, C20A, C20B, C20C	UNUSED	*	*	*	*	1210	*	*
1	D22	UNUSED	*	*	*	*	SOT-23	*	*
1	QT	UNUSED	*	*	*	*	SOT-223	*	*
2	Q1A, Q2A	UNUSED	*	*	*	*	SO-8	*	*

db513\_11-IR3651\_48V-Buck-3.3V\_Eval\_Board\_BOM\_Rev1.42.xls

TYPICAL Output WAVEFORMS  
 Vin=48V, Vo=3.3V, Room Temperature, No Air Flow

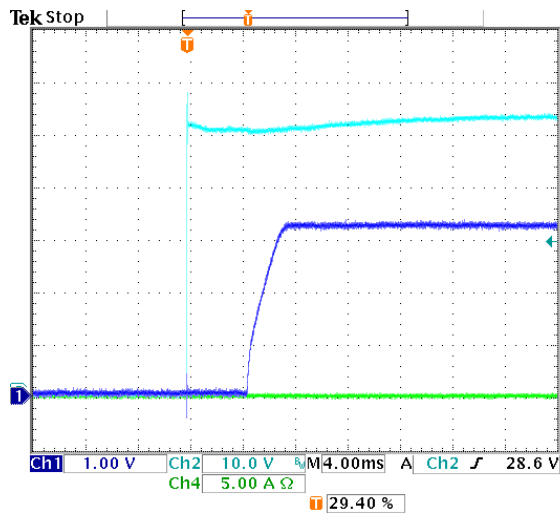

Cyan:  $V_{IN}$   
 Blue:  $V_{OUT}$   
 Green:  $I_{OUT}$

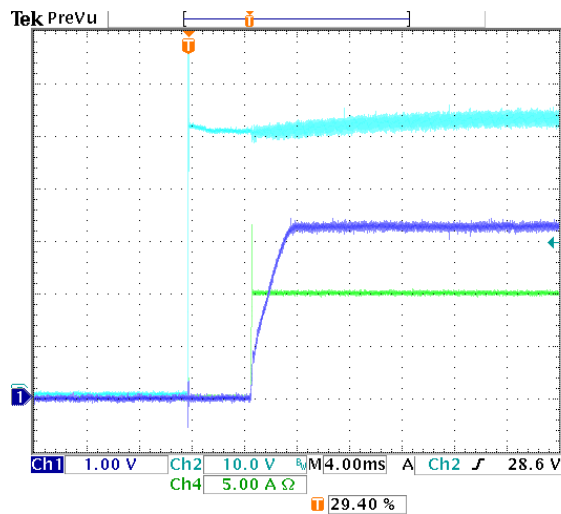

Figure 5 – Startup waveforms



TYPICAL Output WAVEFORMS  
 Vin=48V, Vo=3.3V, Room Temperature, No Air Flow

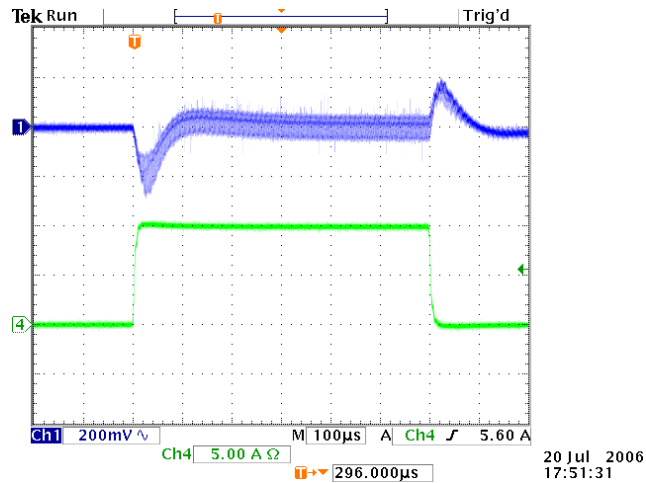

Figure 6 – 0A to 10A Transient

Blue:  $V_{OUT}$

Green:  $I_{OUT}$

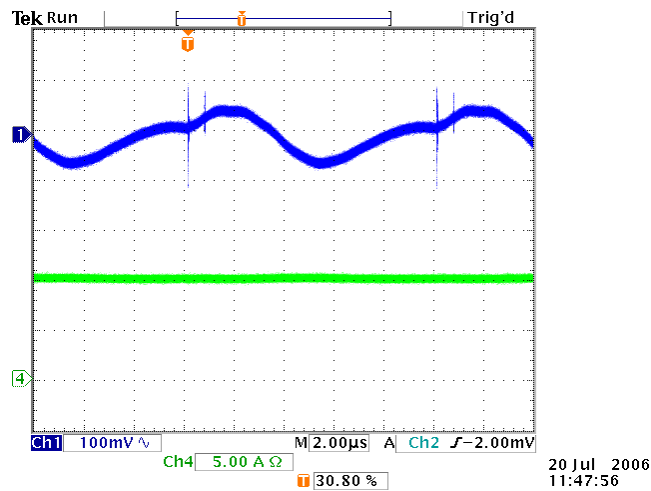
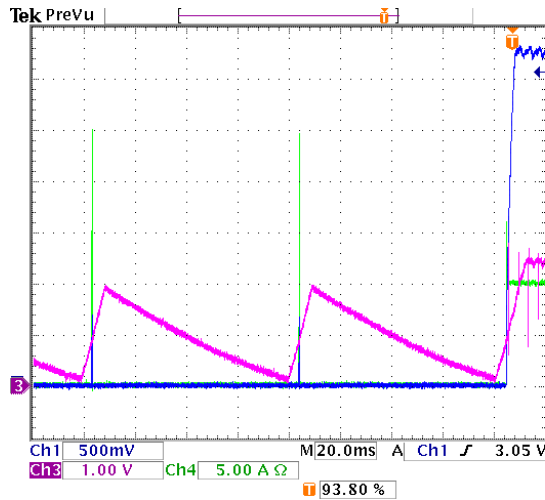

Figure 7 – Output Ripple, 10A load

TYPICAL Output WAVEFORMS  
 Vin=48V, Vo=3.3V, Room Temperature, No Air Flow



Short Circuit :  
 Operation and Recovery

20 Jul 2006  
 12:01:00

Blue:  $V_{OUT}$   
 Green:  $I_{OUT}$   
 Magenta:  $V_{SS}$

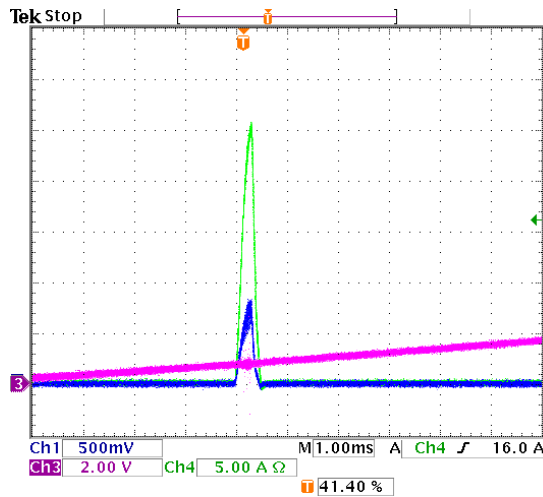

Short Circuit :  
 Detail of "Hiccup"

20 Jul 2006  
 11:51:53

Figure 8 – Short Circuit Response

TYPICAL Output WAVEFORMS  
Vin=48V, Vo=3.3V, Room Temperature, No Air Flow

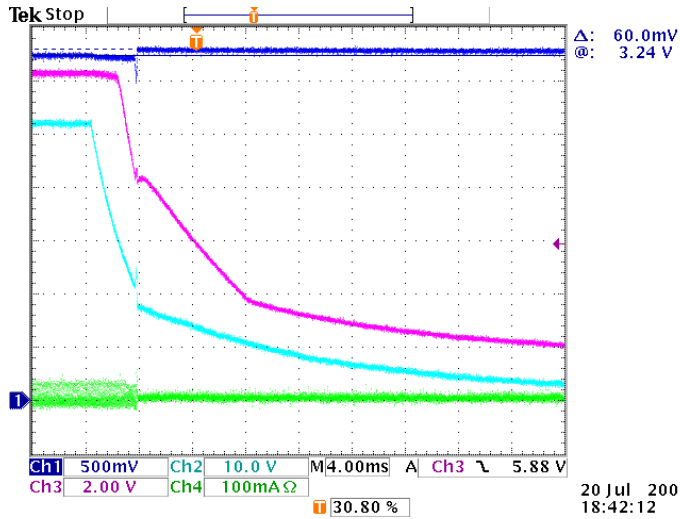

0A Load

Blue:  $V_{OUT}$

Cyan:  $V_{IN}$

Green:  $I_{OUT}$

Magenta:  $V_{SS}$

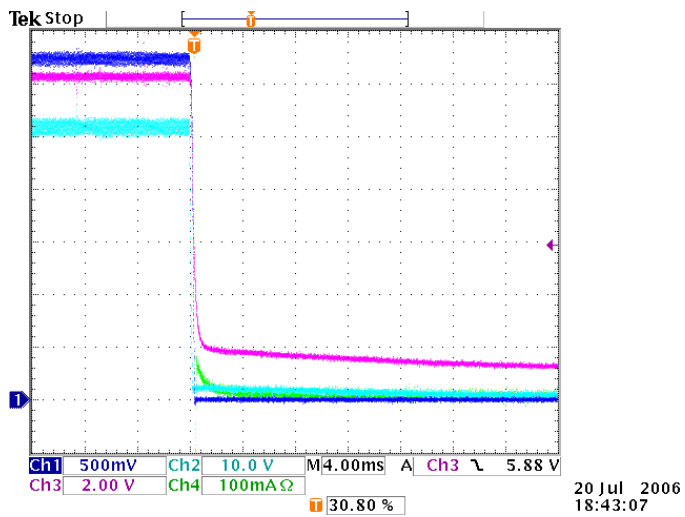

10A Load

Figure 9 – Shutdown

**TYPICAL Output WAVEFORMS**  
 Vin=48V, Vo=3.3V, Room Temperature, No Air Flow

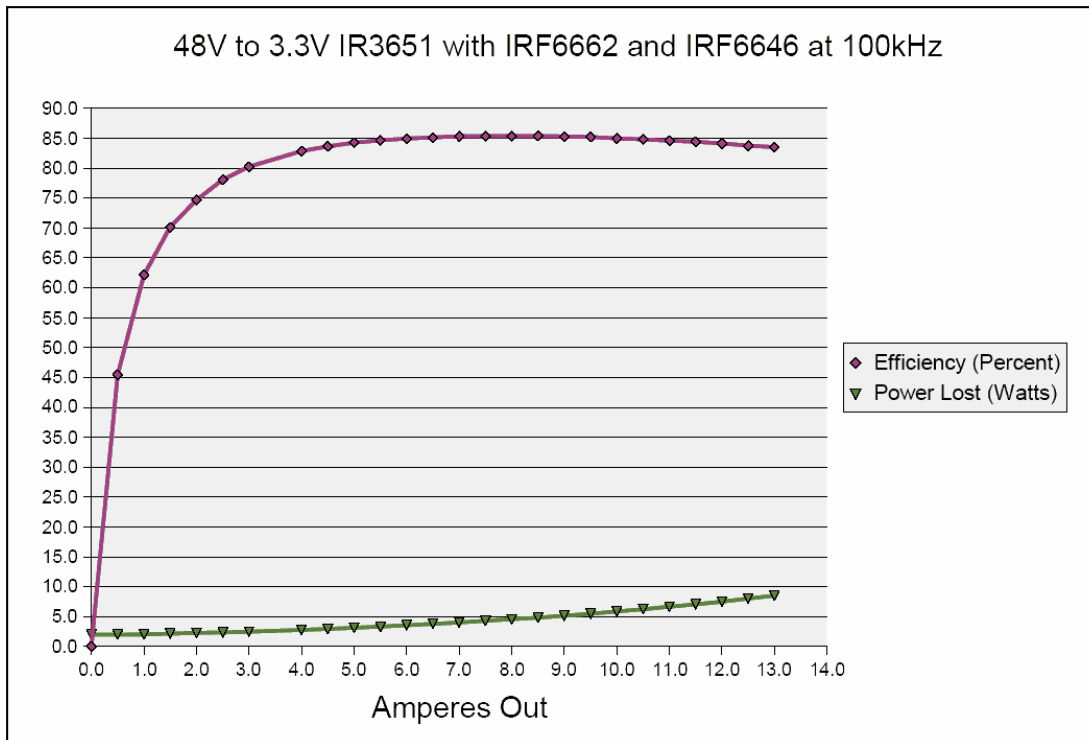

**Figure 10 – Efficiency**

Vin=48V, Vo=3.3V, 10A Load, Room Temperature, No Air Flow



- (1) IR5651 Controller
- (2) Inductor
- (3) Output Capacitors

**Figure 11a – Temperature Distribution, Top side**

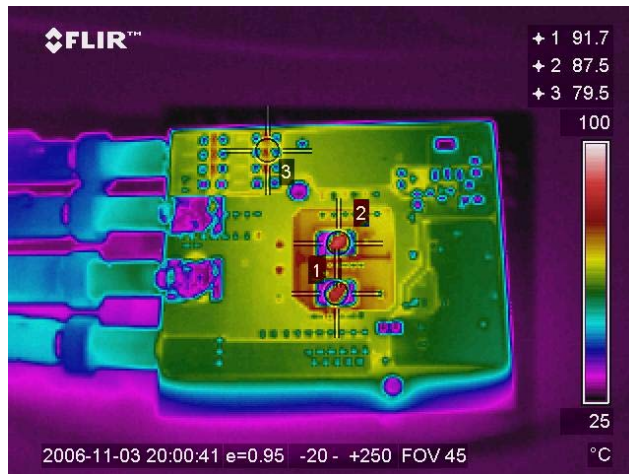

- (1) IRF6646 Sync-Rectifier FET
- (2) IRF6662 Switch FET
- (3) 12V linear supply resistor

**Figure 11b – Temperature Distribution, bottom side**