	-Preliminary-	<b>AP1155ADU</b>
<b>15V Input / 1A Output Adjustable Voltage LDO Regulator</b>		

## 1. General Description

The AP1155ADU is a low dropout linear regulator with ON/OFF control, which can supply 1A load current. The IC is an integrated circuit with a silicon monolithic bipolar structure. The output voltage can be set from 1.3V to 14.0V by external resistors. The output capacitor is available to use a small 0.22 $\mu$ F ceramic capacitor. The over current, thermal and reverse bias protections are integrated, and also the package is high heat radiation type, TO252-5. The IC is designed for high power application.

## 2. Features

- Available to use a small ceramic capacitor
- Dropout Voltage  $V_{\text{DROP}}=300\text{mV}$  at 1A
- Output Current 1A, Peak 1.4A
- High Precision reference voltage  $1.21\text{V} \pm 35\text{mV}$
- Programmable output voltage 1.3V to 14.0V
- High ripple rejection ratio 80dB at 1kHz
- Wide operating voltage range 2.4V to 15.0V
- On/Off control (High active)
- Built-in Short circuit protection, thermal shutdown
- Built-in reverse bias over current protection
- Available very low noise application
- High heat radiation package TO252-5

## 3. Applications

- Automotive accessory equipment
- Power supply for low voltage MPU and the peripherals
- Mobile Communication
- Audio system
- Any Electronic Equipment, etc

<b>4. Table of Contents</b>
-----------------------------

1. General Description .....	1
2. Features .....	1
3. Applications .....	1
4. Table of Contents .....	2
5. Block Diagram .....	3
6. Ordering Information .....	3
7. Pin Configurations and Functions .....	3
■ Pin Configurations .....	3
■ Function .....	4
8. Absolute Maximum Ratings .....	5
9. Recommended Operating Conditions .....	5
10. Electrical Characteristics .....	6
■ Electrical Characteristics of Ta=Tj=25°C .....	6
■ Electrical Characteristics of Ta=-40°C~85°C .....	6
11. Description .....	7
11.1 DC Characteristics .....	7
11.2 Load Transient .....	11
11.3 Line Transient .....	12
11.4 On / Off Transient .....	13
11.5 Ripple Rejection .....	14
11.6 Output Noise .....	15
11.7 Stability .....	16
11.8 Operating Region and Power Dissipation .....	17
12. Definition of term .....	19
13. Recommended External Circuits .....	20
■ V <sub>Out,TYP</sub> =3.0V: Example of selection of external components. ....	20
■ Test Circuit .....	21
14. Package .....	22
■ Outline Dimensions .....	22
IMPORTANT NOTICE .....	23

**5. Block Diagram**

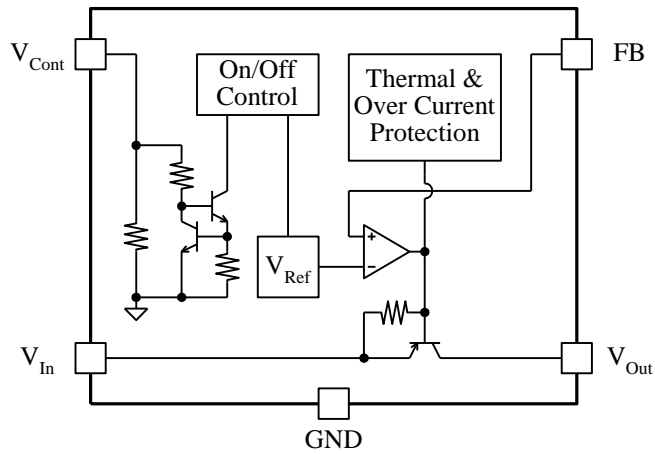

Figure 1. Block Diagram

**6. Ordering Information**

AP1155ADU     $T_a = -40$  to  $85^\circ C$     TO252-5

**7. Pin Configurations and Functions**

■ Pin Configurations

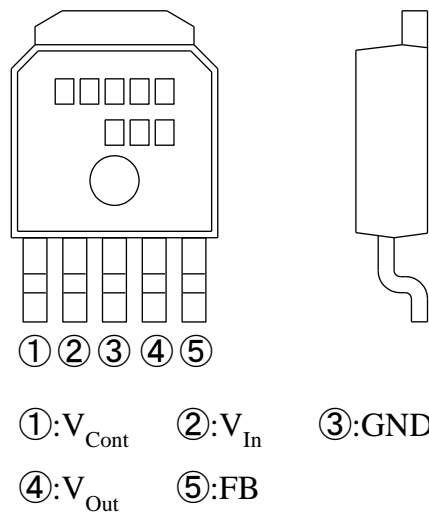

■ Function

Pin Number	Symbol	Internal Equivalent Circuit	Description
1	V <sub>Cont</sub>		<p><b>On/Off control Terminal</b>                      The On/Off voltages are as follows:                      V<sub>Cont</sub> ≥ 1.8V : V<sub>Out</sub> On state                      V<sub>Cont</sub> ≤ 0.35V : V<sub>Out</sub> Off state</p> <p>Pull-down resistance (500kΩ) is built-in.</p>
2	V <sub>In</sub>	-	<p><b>Input Terminal</b>                      Connect a capacitor of 1μF or higher between V<sub>In</sub> terminal and GND.</p>
3	GND	-	<p><b>GND Terminal</b></p>
4	V <sub>Out</sub>		<p><b>Output Terminal</b>                      Connect resistance R<sub>1</sub> between V<sub>Out</sub> terminal and Fb terminal, and resistance R<sub>2</sub> between Fb terminal and GND.</p> <p>Output voltage V<sub>Out,TYP</sub> is determined by the following equation:</p> $V_{Out,TYP} = V_{Fb} \times \frac{R_1 + R_2}{R_2}$ <p>Connect a ceramic capacitor with a capacitance higher than the following values between V<sub>Out</sub> terminal and GND.                      V<sub>Out,TYP</sub> ≥ 2.4V : 1μF                      V<sub>Out,TYP</sub> &lt; 2.4V : 2.2μF</p>
5	FB		<p><b>Feedback Terminal</b>                      Connecting a capacitor between V<sub>Out</sub> terminal and Fb terminal reduces output noise.</p> <p>This terminal features very high impedance; please note that it is susceptible to external noise, etc.</p>

### 8. Absolute Maximum Ratings

Parameter	Symbol	min	Max	Unit	Condition
Input Voltage	$V_{In,MAX}$	-0.4	16	V	
Reverse Bias Voltage	$V_{Rev,MAX}$	-0.4	14	V	$V_{Out}-V_{In}$
FB Terminal Voltage	$V_{FB,MAX}$	-0.4	5	V	
Control Voltage	$V_{Cont,MAX}$	-0.4	16	V	
Junction temperature	$T_j$	-	150	°C	
Storage Temperature Range	$T_{Stg}$	-55	150	°C	
Power Dissipation	$P_D$	-	830	mW	Unit, Internal Limited $T_j=145^{\circ}C$ (Note 1)
		-	2200	-	30mm*30mm*1mm(When Installed On a PCB), Internal Limited (Note 2)

Note 1.  $P_D$  must be decreased at the rate of 6.9mW/°C for operation above 25°C.

Note 2.  $P_D$  must be decreased at the rate of 18.3mW/°C for operation above 25°C.

**WARNING:** The maximum ratings are the absolute limitation values with the possibility of the IC breakage. When the operation exceeds this standard quality cannot be guaranteed.

### 9. Recommended Operating Conditions

Parameter	Symbol	min	typ	max	Unit	Condition
Operating Temperature Range	$T_a$	-40	-	85	°C	
Operating Voltage Range	$V_{OP}$	2.4	-	15.0	V	
Output Voltage Range	$V_{Out}$	1.3	-	14.0	V	

## 10. Electrical Characteristics

### ■ Electrical Characteristics of Ta=Tj=25°C

The parameters with min or max values will be guaranteed at  $T_a=T_j=25^\circ\text{C}$ .

( $V_{In}=4.0\text{V}$ ,  $R_1=53\text{k}\Omega$ ,  $R_2=36\text{k}\Omega$ ,  $V_{cont}=1.8\text{V}$ ,  $T_a=T_j=25^\circ\text{C}$ , unless otherwise specified.)

Parameter	Symbol	Condition	min	typ	max	Unit
Fb voltage	$V_{FB}$	$I_{Out}=5\text{mA}$	1.185	1.210	1.245	V
Line Regulation	LinReg	$\Delta V_{In}=5\text{V}$ , $I_{Out}=5\text{mA}$	-	0	10	mV
Load Regulation (Note 3)	LoaReg	$I_{Out}=5\sim 500\text{mA}$	-	6	20	mV
		$I_{Out}=5\sim 1000\text{mA}$	-	20	35	
Dropout Voltage (Note 4)	$V_{Drop}$	$I_{Out}=500\text{mA}$	-	150	260	mV
		$I_{Out}=1000\text{mA}$	-	300	490	
		$V_{Out}=V_{Out,TYP}\times 0.9$			1400	-
Maximum Output Current (Note 5)	$I_{Out,Max}$	$I_{Out}=0\text{mA}$	-	300	480	$\mu\text{A}$
Quiescent Current	$I_q$	$V_{Cont}=0\text{V}$	-	-	0.1	$\mu\text{A}$
Standby Current	$I_{Standby}$	$V_{Cont}=1.8\text{V}$	-	5	10	$\mu\text{A}$
Control Current	$I_{Cont}$	$V_{Out}$ On state	1.8	-	-	V
Control Voltage	$V_{Cont}$	$V_{Out}$ Off state	-	-	0.35	V

Note 3. Load Regulation changes with output voltage. The value mentioned above is guaranteed with the condition at  $V_{Out,TYP}=3.0\text{V}$  ( $R_1=53\text{k}\Omega$ ,  $R_2=36\text{k}\Omega$ ). The standard value is displayed by the absolute value.

Note 4. For  $V_{Out,TYP}\leq 2.0\text{V}$ , no regulations.

Note 5. The maximum output current is limited by power dissipation

Note 6. Parameters with only typical values are just reference. (Not guaranteed)

### ■ Electrical Characteristics of Ta=-40°C~85°C

The parameters with min or max values will be guaranteed at  $T_a = -40 \sim 85^\circ\text{C}$ .

( $V_{In}=4.0\text{V}$ ,  $R_1=53\text{k}\Omega$ ,  $R_2=36\text{k}\Omega$ ,  $V_{cont}=1.8\text{V}$ ,  $T_a = -40 \sim 85^\circ\text{C}$ , unless otherwise specified.)

Parameter	Symbol	Condition	min	typ	max	Unit
Fb voltage	$V_{FB}$	$I_{Out}=5\text{mA}$	1.175	1.210	1.255	V
Line Regulation	LinReg	$\Delta V_{In}=5\text{V}$ , $I_{Out}=5\text{mA}$	-	0	16	mV
Load Regulation (Note 7)	LoaReg	$I_{Out}=5\sim 500\text{mA}$	-	6	37	mV
		$I_{Out}=5\sim 1000\text{mA}$	-	20	65	
Dropout Voltage (Note 8)	$V_{Drop}$	$I_{Out}=500\text{mA}$	-	150	335	mV
		$I_{Out}=1000\text{mA}$	-	300	550	
		$V_{Out}=V_{Out,TYP}\times 0.9$			1400	-
Maximum Output Current (Note 9)	$I_{Out,Max}$	$I_{Out}=0\text{mA}$	-	300	585	$\mu\text{A}$
Quiescent Current	$I_q$	$V_{Cont}=0\text{V}$	-	-	0.5	$\mu\text{A}$
Standby Current	$I_{Standby}$	$V_{Cont}=1.8\text{V}$	-	5	15	$\mu\text{A}$
Control Current	$I_{Cont}$	$V_{Out}$ On state	1.8	-	-	V
Control Voltage	$V_{Cont}$	$V_{Out}$ Off state	-	-	0.35	V

Note 7. Load Regulation changes with output voltage. The value mentioned above is guaranteed with the condition at  $V_{Out,TYP}=3.0\text{V}$  ( $R_1=53\text{k}\Omega$ ,  $R_2=36\text{k}\Omega$ ). The standard value is displayed by the absolute value.

Note 8. For  $V_{Out,TYP}\leq 2.0\text{V}$ , no regulations.

Note 9. The maximum output current is limited by power dissipation

Note 10. Parameters with only typical values are just reference. (Not guaranteed)

**11. Description**

**11.1 DC Characteristics**

■  $\Delta V_{Out}$  vs  $V_{In}$  (AP1155ADU)

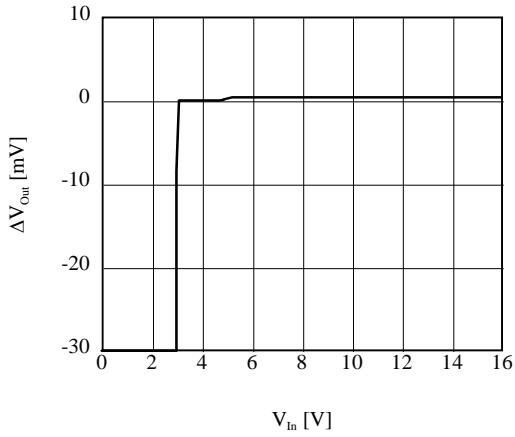

■  $\Delta V_{Out}$  vs  $V_{In}$  (AP1155ADU)

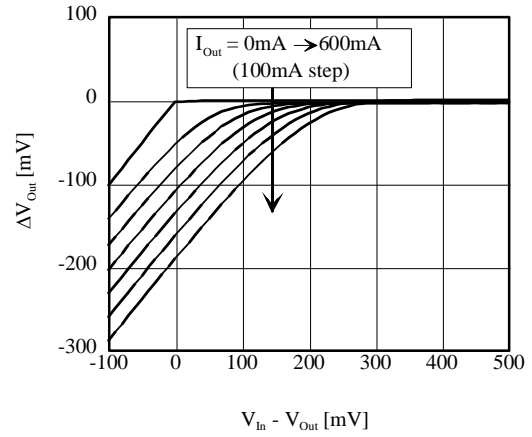

■  $I_Q$  vs  $V_{In}$  (AP1155ADU)

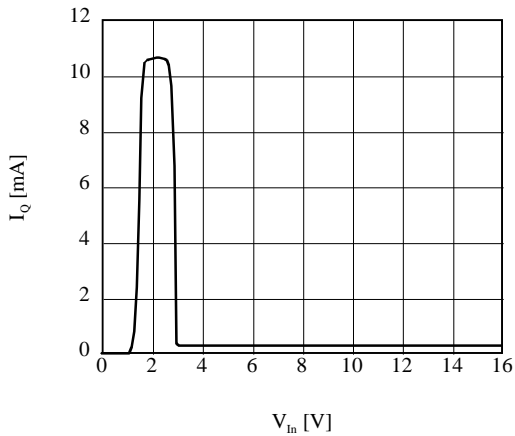

■  $I_Q$  vs  $V_{In}$  (AP1155ADU)

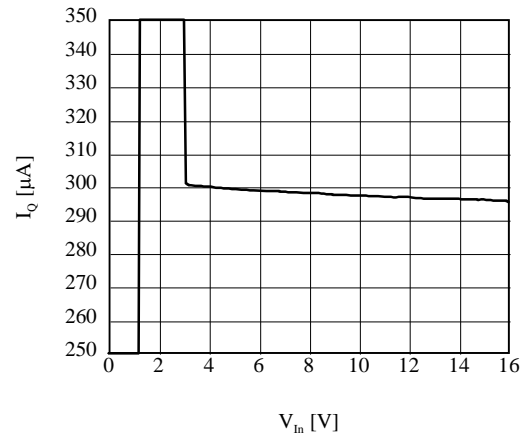

■  $\Delta V_{Out}$  vs  $I_{Out}$  (AP1155ADU)

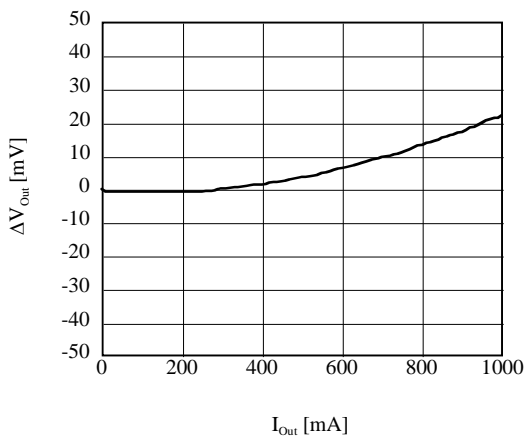

■  $I_{GND}$  vs  $I_{Out}$  (AP1155ADU)

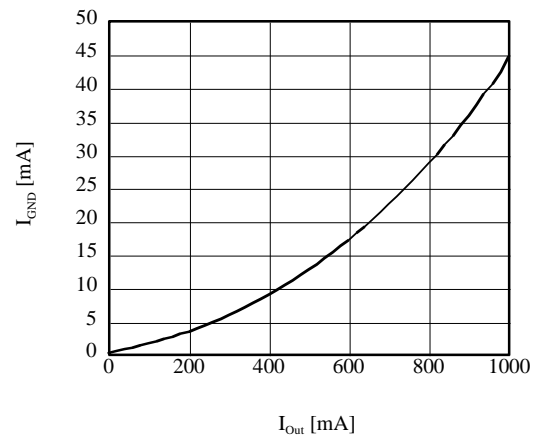

■  $V_{Drop}$  vs  $I_{Out}$  (AP1155ADU)

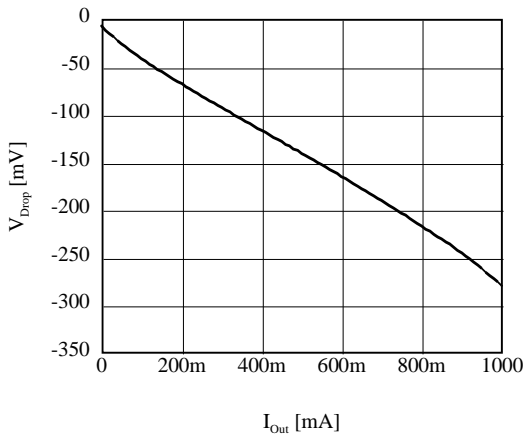

■  $V_{Drop}$  vs  $I_{Out}$  (AP1155ADU)

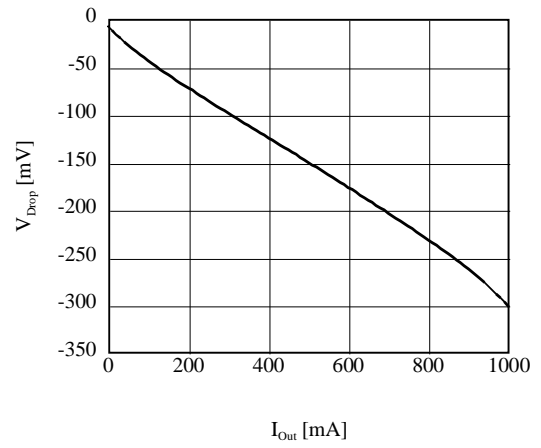

■  $V_{Out}$  vs  $I_{Out}$  (AP1155ADU)

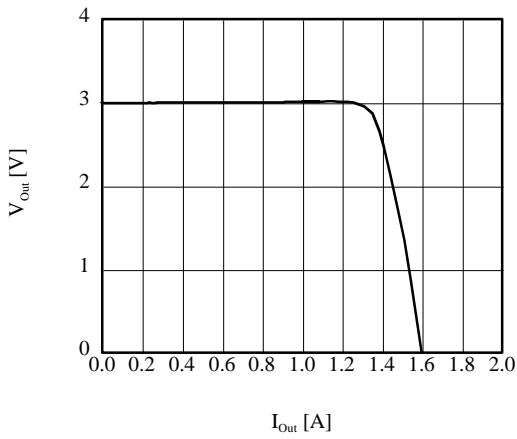

■  $I_{Cont}$  vs  $V_{Cont}$  (AP1155ADU)

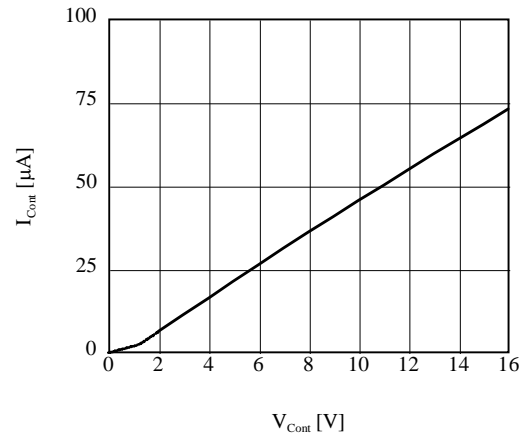

■  $V_{Out}$  vs  $V_{Cont}$  (AP1155ADU)

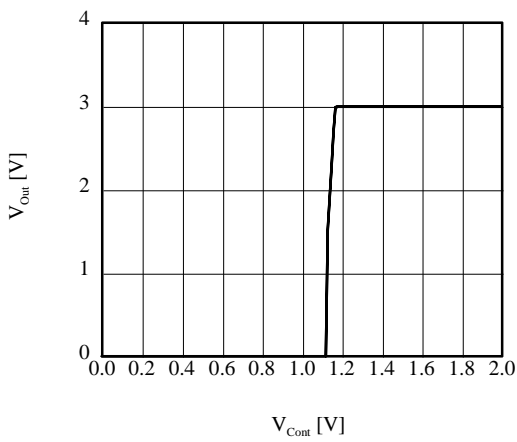

■  $I_{Standby}$  vs  $V_{In}$  (AP1155ADU)

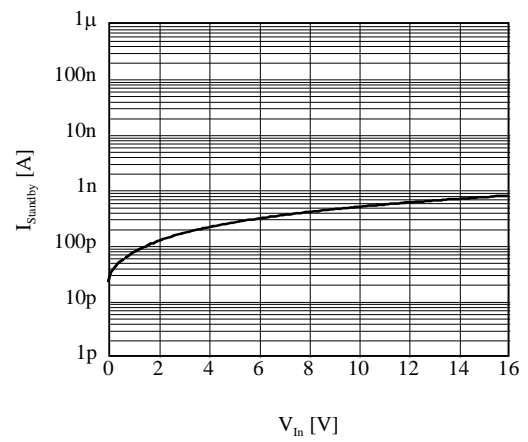



■  $\Delta V_{Out}$  vs  $T_a$  (AP1155ADU)

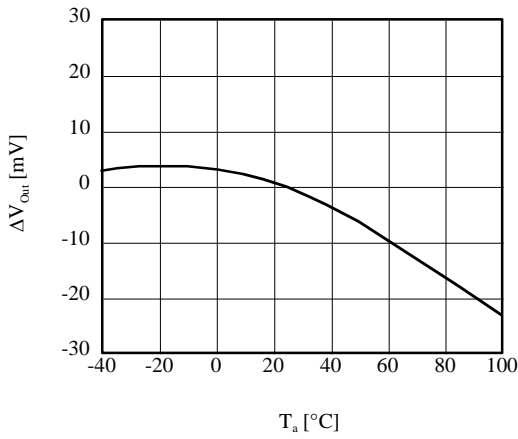

■  $I_Q$  vs  $T_a$  (AP1155ADU)

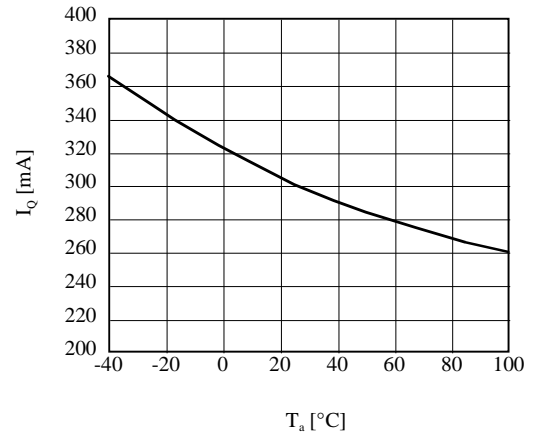

■  $LoaReg$  vs  $T_a$  (AP1155ADU)

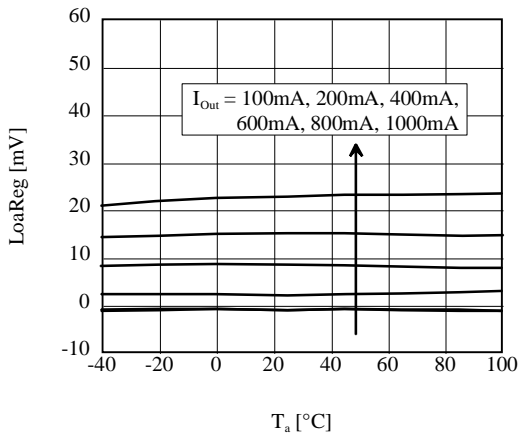

■  $I_{GND}$  vs  $T_a$  (AP1155ADU)

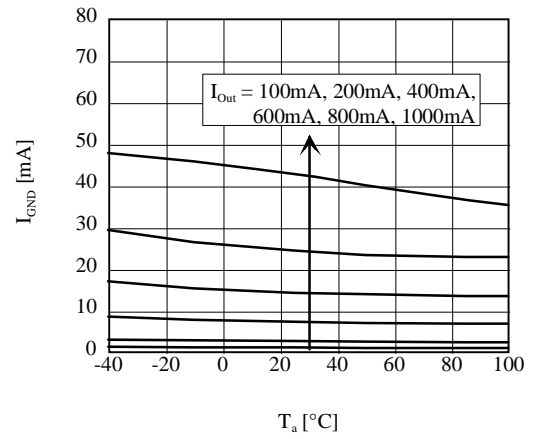

■  $V_{Drop}$  vs  $T_a$  (AP1155ADU)

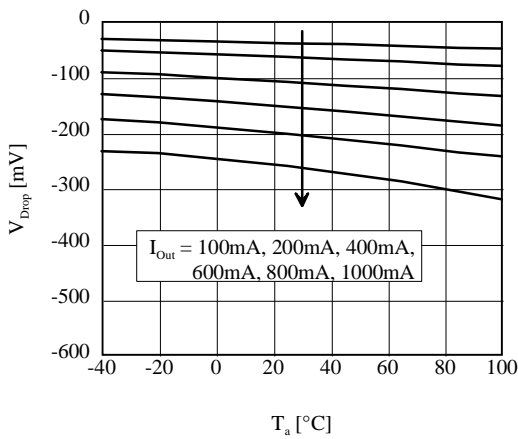

■  $V_{Drop}$  vs  $T_a$  (AP1155ADU)

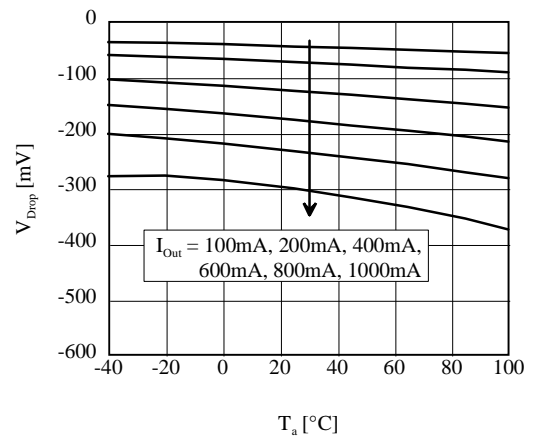

■  $V_{Out}$  On/Off Point vs  $T_a$  (AP1155ADU)

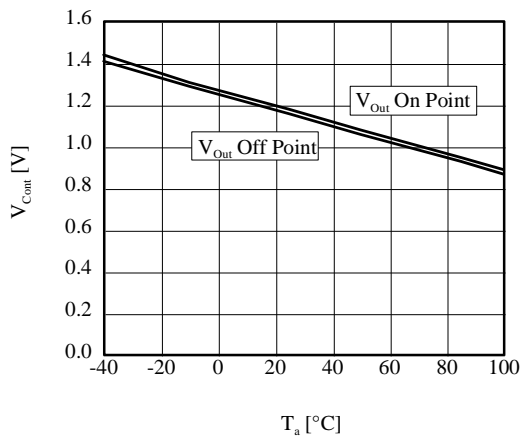

■  $I_{Cont}$  vs  $T_a$  (AP1155ADU)

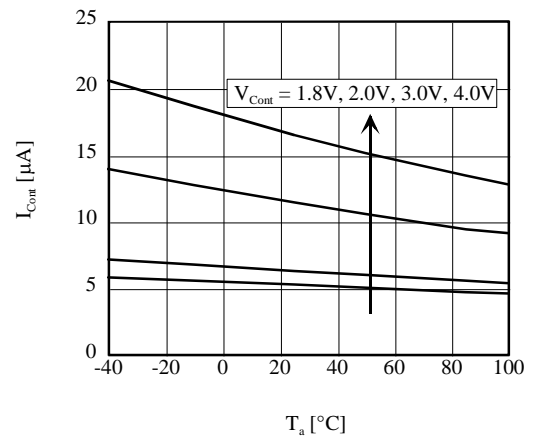

■  $I_{Out,MAX}$  vs  $T_a$  (AP1155ADU)

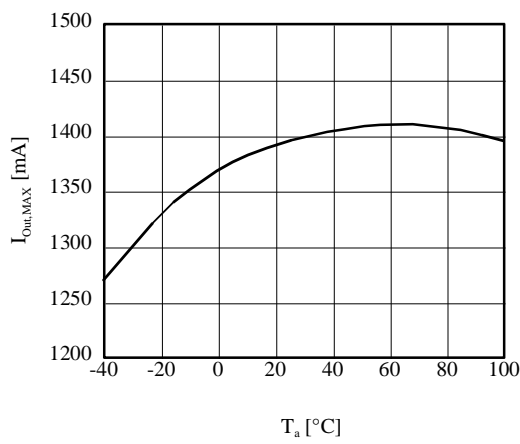

■ Reverse Bias Current( $I_{Rev}$ ) vs  $T_a$  (AP1155ADU)

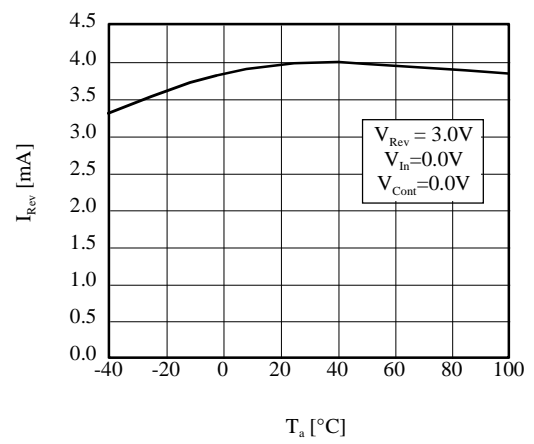

11.2 Load Transient

■  $I_{Out}=0mA \rightarrow 1000mA$ ,  $C_{Out}=1.0\mu F, 2.2\mu F, 4.7\mu F$

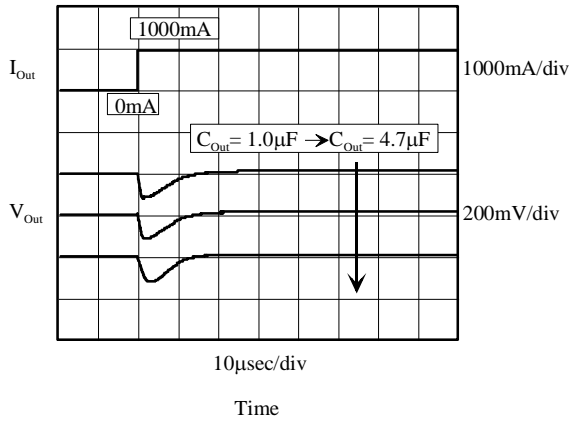

■  $I_{Out}=1000mA \rightarrow 0mA$ ,  $C_{Out}=1.0\mu F, 2.2\mu F, 4.7\mu F$

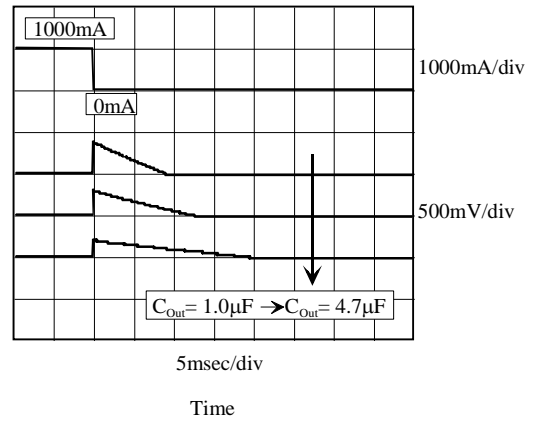

■  $I_{Out}=0mA \rightarrow 500mA, 0mA \rightarrow 1000mA$

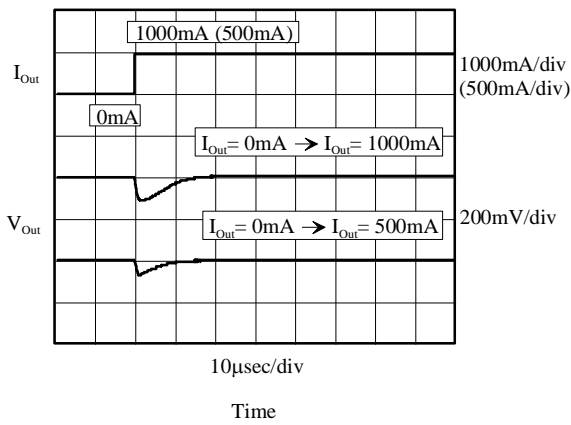

■  $I_{Out}=500mA \rightarrow 0mA, 1000mA \rightarrow 0mA$

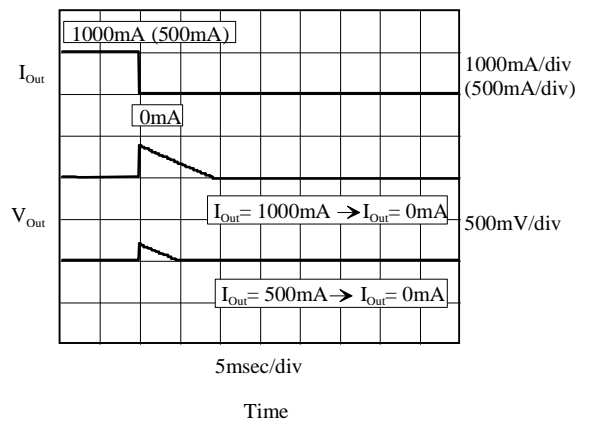

■  $I_{Out}=0mA \rightarrow 1000mA, 10mA \rightarrow 1010mA$

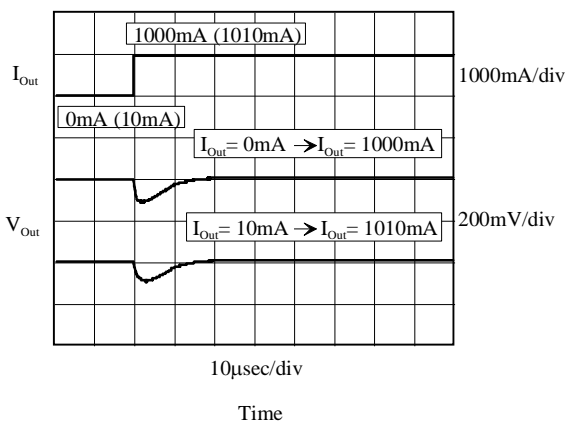

■  $I_{Out}=1000mA \rightarrow 0mA, 1010mA \rightarrow 10mA$

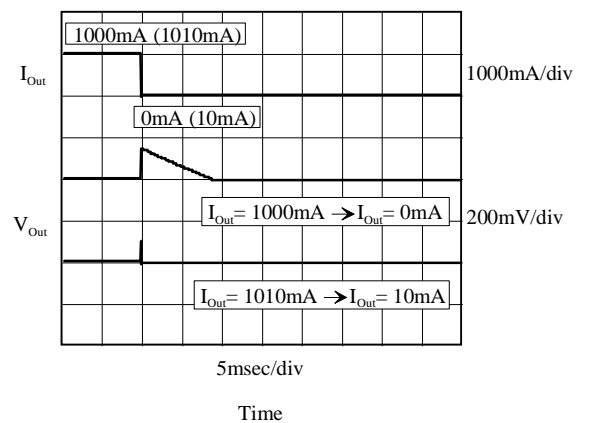

11.3 Line Transient

■  $I_{Out}=100mA, 500mA, 1000mA$

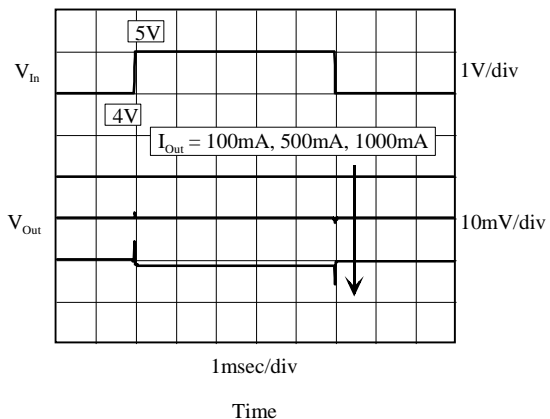

■  $C_{Out}=1.0\mu F, 2.2\mu F, 4.7\mu F$

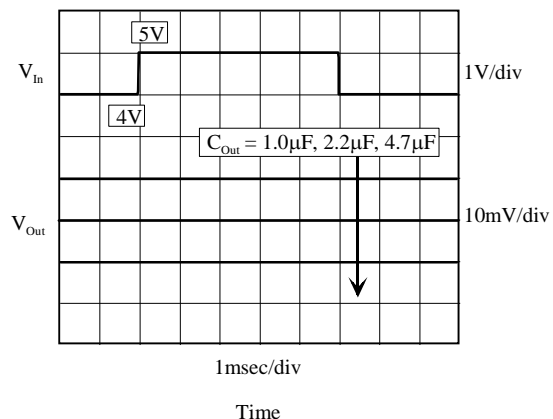

■  $C_{FB}=none, 1000pF, 0.1\mu F$

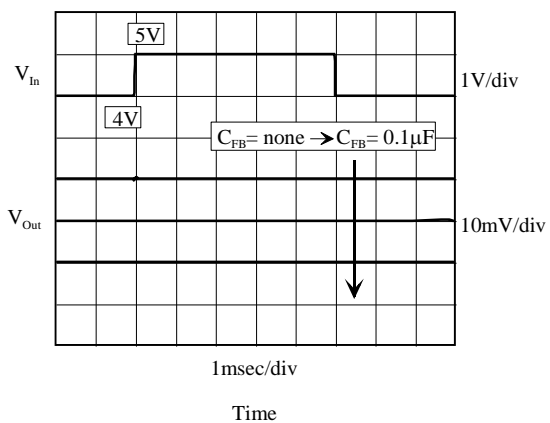

11.4 On / Off Transient

■  $V_{Cont}=0.0V \rightarrow 2.0V$ ,  $C_{Out}=1.0\mu F, 4.7\mu F, 10\mu F$

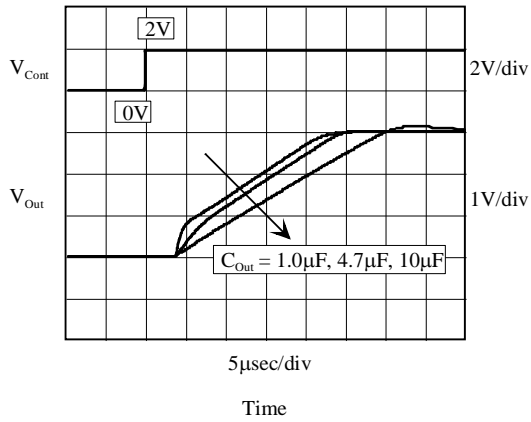

■  $V_{Cont}=2.0V \rightarrow 0.0V$ ,  $C_{Out}=1.0\mu F, 4.7\mu F, 10\mu F$

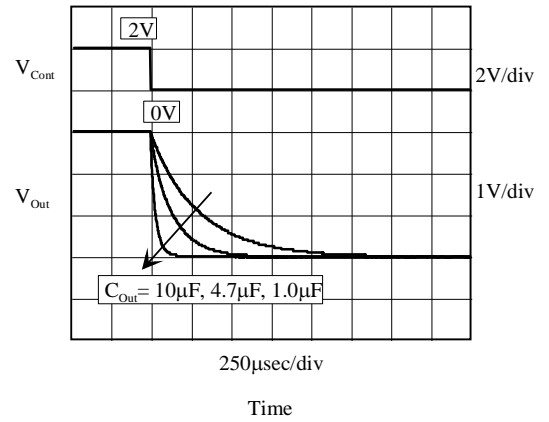

■  $V_{Cont}=0.0V \rightarrow 2.0V$ ,  $I_{Out}=100mA, 500mA, 1000mA$

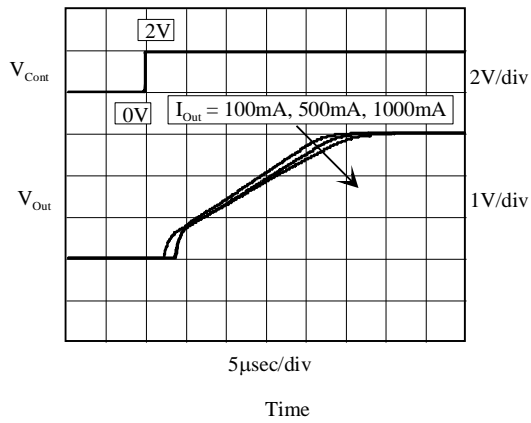

■  $V_{Cont}=2.0V \rightarrow 0.0V$ ,  $I_{Out}=100mA, 500mA, 1000mA$

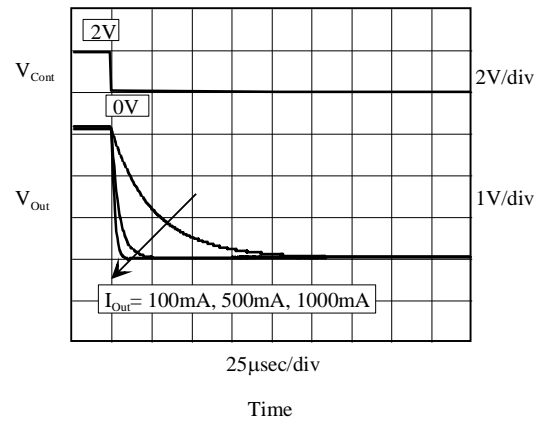

■  $V_{Cont}=0.0V \rightarrow 2.0V$ ,  $C_{Fb}=\text{none} \sim 0.1\mu F^*$

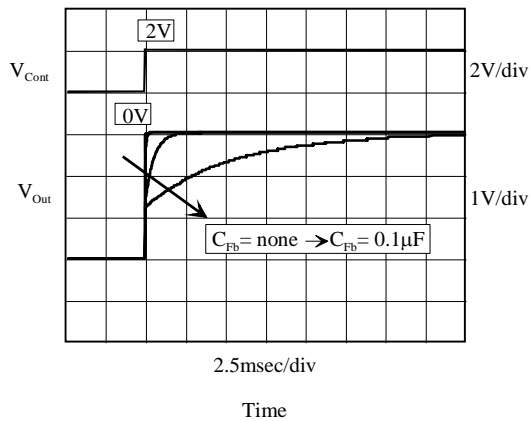

■  $V_{Cont}=0.0V \rightarrow 2.0V$ ,  $C_{Fb}=\text{none} \sim 0.1\mu F^*$

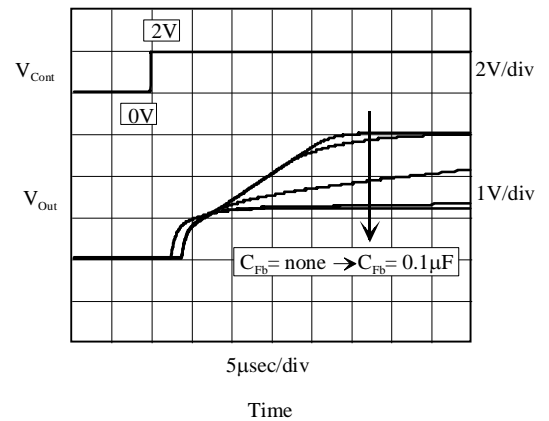

※  $C_{Fb}=\text{none}, 100pF, 1000pF, 0.001\mu F, 0.01\mu F, 0.1\mu F$

### 11.5 Ripple Rejection

■  $I_{Out}=100\text{mA}, 200\text{mA}, 500\text{mA}, 1000\text{mA}$

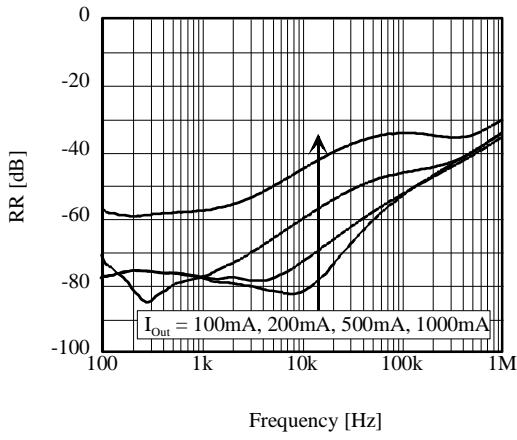

■  $C_{Out}=1.0\mu\text{F}, 2.2\mu\text{F}, 4.7\mu\text{F}, 10\mu\text{F}$

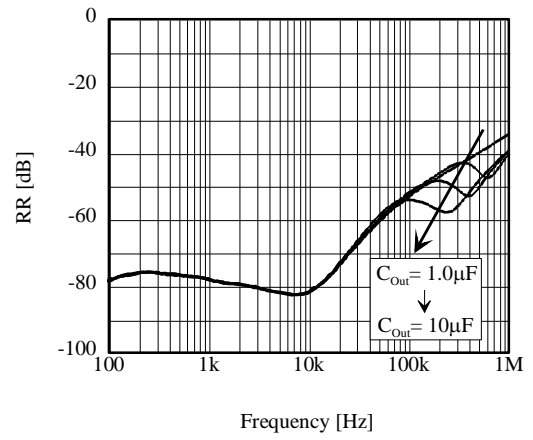

■  $C_{Fb}=\text{none}, 0.1\mu\text{F}$

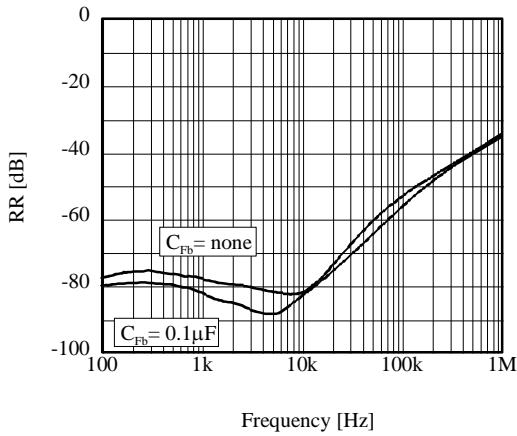

■  $I_{Out}=1\text{mA}\sim 1000\text{mA}, f=1\text{kHz}$

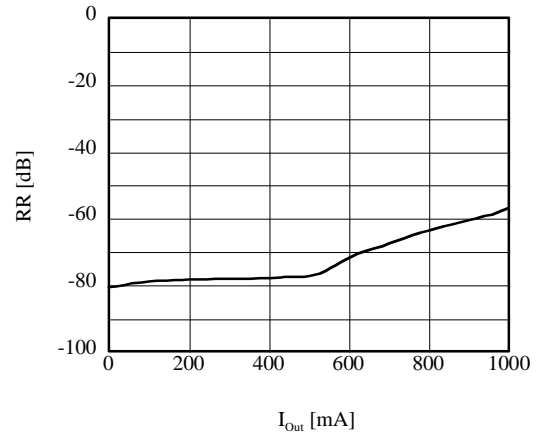

### 11.6 Output Noise

■  $V_{Out,TYP}=3.0V, I_{Out}=0.1mA\sim 1000mA$

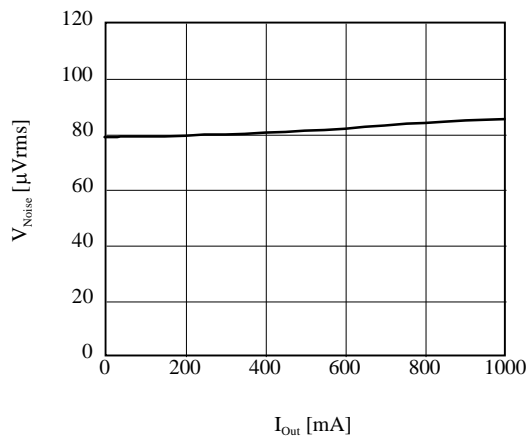

■  $V_{Out,TYP}=3.0V, C_{Fb}=1pF\sim 0.1\mu F$

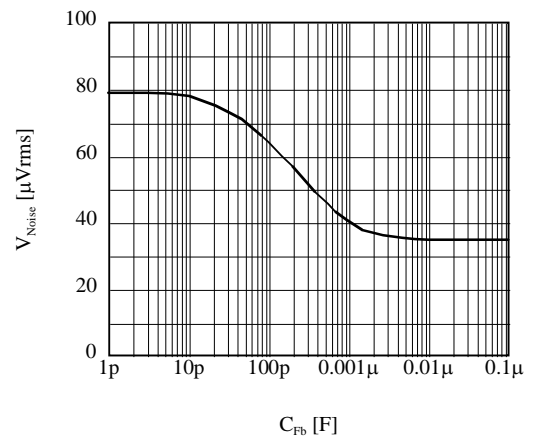

■  $V_{Out,TYP}=1.3V \sim 12V$

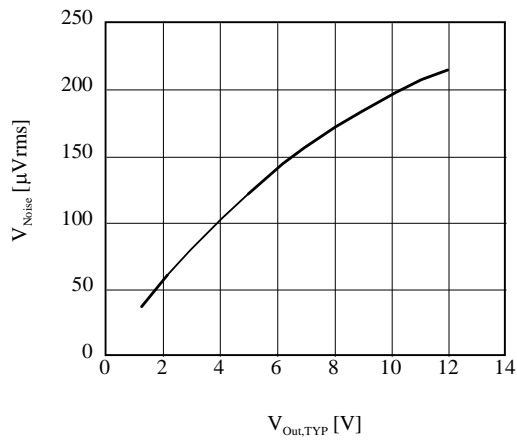

### 11.7 Stability

The standard capacitor recommended for use on the output side is a ceramic capacitor equal to or greater than  $1.0\mu\text{F}$ . For operations at  $2.4\text{V}$  or less, use at least a  $2.2\mu\text{F}$  capacitor.

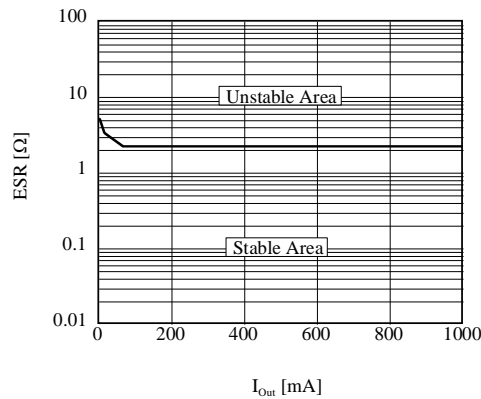

Figure 2. Stable operation area when  $V_{\text{Out, TYP}}=3.0\text{V}$

The above graph indicates that operation is stable in the entire current range with a resistance of  $1\Omega$  or less (equivalent series resistance or 'ESR') connected in series to the output capacitor. Generally, the ESR of a ceramic capacitor is very low (several tens of  $\text{m}\Omega$ ), and no problems should arise in actual use. If an application requires use of a large ESR capacitor, connecting a ceramic capacitor with low ESR in parallel will enable operations at this level. When parallel output capacitors are used, be sure to position the ceramic capacitor as close to the IC as possible. The other capacitor connected in parallel may be located away from the IC. The IC will not be damaged by the increased capacitance. Input capacitors are necessary when the power supply impedance increases due to battery depletion or when the line to the power supply is particularly long. There is no general rule that can be used to determine the required number of capacitors used for such purposes. In some cases, only one capacitor is necessary for several regulator ICs. In some cases, one capacitor is required for each IC. To determine the required number of capacitors in a specific application, be sure to verify operation with all parts in the installed configuration.

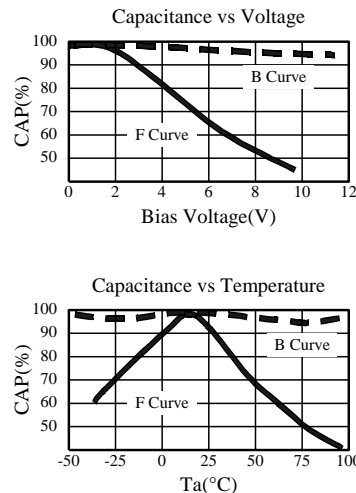

Figure 3. General characteristics of ceramic capacitors

Ceramic capacitors normally have specific temperature and voltage characteristics. Be sure to take the operating voltage and temperature into consideration when selecting parts for use. We recommend parts featuring B characteristics.

For evaluation

Kyocera : CM05B104K10AB , CM05B224K10AB , CM105B104K16A , CM105B224K16A , CM21B225K10A

Murata : GRM36B104K10 , GRM42B104K10 , GRM39B104K25 , GRM39B224K10 , GRM39B105K6.3



### 11.8 Operating Region and Power Dissipation

Power dissipation capability is limited by the junction temperature that triggers the built-in overheat protection circuit. Therefore, power dissipation capability is regarded as an internal limitation. The package itself does not offer high heat dissipation because of its small size. The package is, however, designed to release heat effectively when mounted on the PCB. Therefore, the heat-dissipation value will vary depending on the material, copper pattern, etc. of the PCB on which the package is mounted.

When the regulator loss is large (high ambient temperature, poor heat radiation), the overheat protection circuit is activated. When this occurs, output current cannot be obtained, and an output voltage drop is observed. When the junction temperature reaches the set value, the IC stops operating. However, after the IC has stopped operation and the junction temperature lowers sufficiently, the IC restarts operation immediately.

#### • How to determine the thermal resistance when installation on PCB

The chip junction temperature during operation is expressed by

$$T_j = \theta_{ja} \times P_D + 25$$

The junction temperature of the AP1155ADU is limited to approximately 145°C by the overheat protection circuit.  $P_D$  is the value observed when the overheat protection circuit is activated. The following example is based on an ambient temperature of 25°C.

$$145 = \theta_{ja} \times P_D + 25$$

$$\theta_{ja} \times P_D = 120$$

$$\theta_{ja} = \frac{120}{P_D} \text{ (}^\circ\text{C/W)}$$

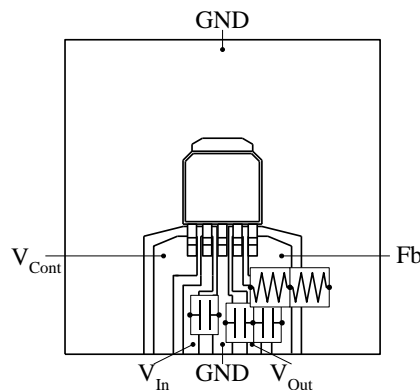

Figure 4. Example of AP1155ADU installation on circuit board  
Glass epoxy substrate with double-layer wiring (copper pattern thickness: 35μm)

In the above installation example,  $P_D$  is 2200mW. If the temperature exceeds 25°C, be sure to derate at -18.3mW/°C.

•  **$P_D$  is easily calculated.**

With the output terminal shorted-circuited to GND, gradually increase the input voltage and measure the input current. Slowly increase the input voltage to about 10V. The initial input current value becomes the maximum instantaneous output current value, but gradually lowers as the chip temperature rises, and ultimately reaches a state of thermal equilibrium (through natural air cooling).  $P_D$  is calculated using the input value for input current and the input voltage value in the equilibrium state.

$$P_D \cong V_{In} \times I_{In}$$

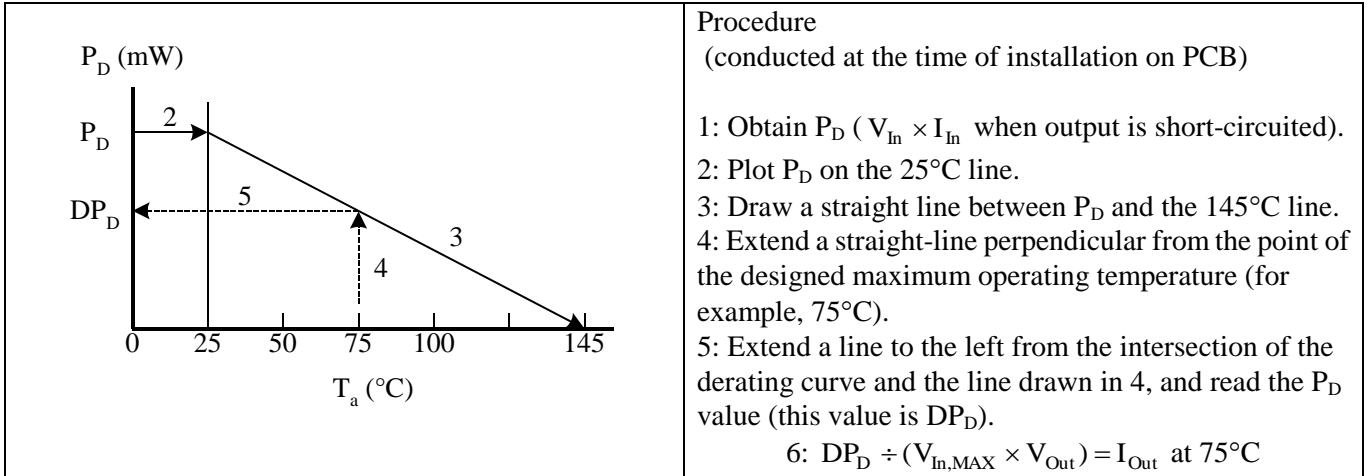

The maximum operating current at the maximum temperature is as follows:

$$I_{Out} \cong \{DP_D \div (V_{In,MAX} - V_{Out})\}$$

Try to achieve maximum heat dissipation in your design in order to minimize the part's temperature during operation. Generally speaking, lower part temperatures result in higher reliability in operation.

## 12. Definition of term

### ■ Characteristics

#### • Output Voltage ( $V_{Out}$ )

The output voltage is specified with  $V_{In}=V_{Out,TYP}+1V$  and  $I_{Out}=5mA$ .

#### • Output Current ( $I_{Out}$ )

Output current, which can be used continuously (It is the range where overheating protection of the IC does not operate).

#### • Maximum output current ( $I_{Out,Max}$ )

The rated output current is specified under the condition where the output voltage drops 0.9V times the value specified with  $I_{Out}=5mA$  by increasing the output current. The input voltage is set to  $V_{Out,TYP}+1V$  and the current is pulsed to minimize temperature effect.

#### • Dropout Voltage ( $V_{Drop}$ )

It is the difference between the input voltage and the output voltage when the circuit stops the stable operation by decreasing the input voltage. It is measured when the output voltage drops 100mV from its nominal value by decreasing the input voltage gradually.

#### • Line Regulation (LinReg)

It is the fluctuations of the output voltage value when the input voltage is changed.

#### • Load Regulation (LoaReg)

It is the fluctuations of the output voltage value when the input voltage is assumed to be  $V_{Out,TYP}+1V$ , and the output current is changed.

#### • Ripple Rejection (RR)

Ripple rejection is the ability of the regulator to attenuate the ripple content of the input voltage at the output. It is measured with the condition of  $V_{In}=V_{Out,TYP}+1.5V$ . Ripple rejection is the ratio of the ripple content between the output vs. input and is expressed in dB

#### • Standby Current ( $I_{Standby}$ )

Standby current is the current which flows into the regulator when the output is turned off by the control function ( $V_{Cont}=0V$ ).

### ■ Protections

#### • Over Current Protection

It is a function to protect the IC by limiting the output current when excessive current flows to IC, such as the output is connected to GND, etc.

#### • Thermal Protection

It protects the IC not to exceed the permissible power consumption of the package in case of large power loss inside the regulator. The output is turned off when the chip reaches around 145°C, but it turns on again when the temperature of the chip decreases.

#### • ESD

MM: 200pF 0Ω 200V or over

HBM: 100pF 1.5kΩ 2000V or over

### 13. Recommended External Circuits

#### ■ $V_{\text{Out,TYP}}=3.0\text{V}$ : Example of selection of external components.

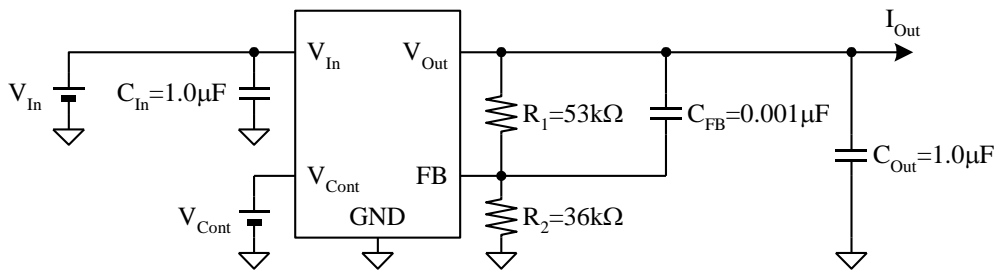

Figure 5. External Circuit

The output voltage value  $V_{\text{Out,TYP}}$  is determined using the following equation:

$$V_{\text{Out,TYP}} = \frac{R_1 + R_2}{R_2} \times V_{\text{Fb}}$$

The minimum required current through resistance  $R_1$ ,  $R_2$  is  $30\mu\text{A}$ , which is determined by  $V_{\text{Fb}} \div R_2$ .

Only a ceramic capacitor should be used for  $C_{\text{Out}}$ . For  $C_{\text{In}}$  any type of capacitor may be selected. For  $C_{\text{Out}}$  and  $C_{\text{In}}$ , use capacitors rated at  $1\mu\text{F}$  or higher. For details, refer to [11.7 Stability](#).

The Fb terminal has high impedance and is therefore susceptible to external noise, etc. Connecting capacitor  $C_{\text{Fb}}$  between the  $V_{\text{Out}}$  terminal and the Fb terminal minimizes the effects of external noise and also reduces output noise.

■ Test Circuit

■ Test circuit for DC characteristics

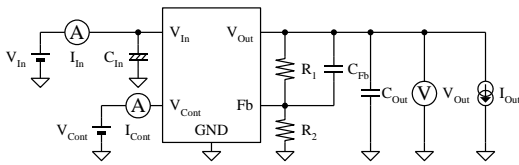

$V_{Out,TYP}=3.0V (R_1=53k\Omega, R_2=36k\Omega)$   
 $V_{In}=4.0V, V_{Cont}=1.8V, I_{Out}=5mA$   
 $C_{In}=1.0\mu F(\text{Tantalum}), C_{Fb}=0.001\mu F(\text{Ceramic}),$   
 $C_{Out}=1.0\mu F(\text{Ceramic}), T_a=25^\circ C$

■ Test circuit for Load Transient

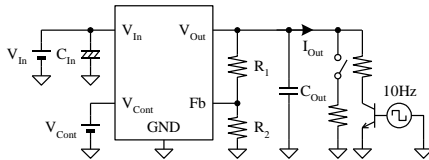

$V_{Out,TYP}=3.0V (R_1=53k\Omega, R_2=36k\Omega)$   
 $V_{In}=4.0V, V_{Cont}=1.8V$   
 $C_{In}=1.0\mu F(\text{Tantalum}), T_a=25^\circ C$

■ Test circuit for Line Transient

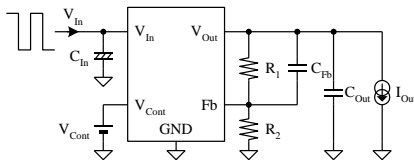

$V_{Out,TYP}=3.0V (R_1=53k\Omega, R_2=36k\Omega)$   
 $V_{In}=4.0V \leftrightarrow 5.0V(100Hz), V_{Cont}=1.8V, I_{Out}=100mA$   
 $C_{In}=1.0\mu F(\text{Tantalum}), C_{Fb}=\text{none}, T_a=25^\circ C$

■ Test circuit for On/Off Transient

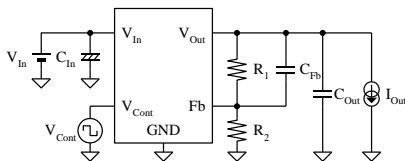

$V_{Out,TYP}=3.0V (R_1=53k\Omega, R_2=36k\Omega)$   
 $V_{In}=4.0V, V_{Cont}=0.0V \leftrightarrow 2.0V(10Hz), I_{Out}=100mA$   
 $C_{In}=1.0\mu F(\text{Tantalum}), C_{Fb}=\text{none}, T_a=25^\circ C$

■ Test circuit for Ripple Rejection

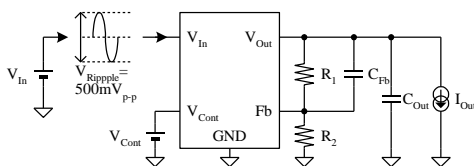

$V_{Out,TYP}=3.0V (R_1=53k\Omega, R_2=36k\Omega)$   
 $V_{In}=4.5V, V_{Cont}=2.0V, V_{Ripple}=500mV_{p-p}, I_{Out}=100mA$   
 $C_{In}=\text{none}, C_{Fb}=\text{none}, T_a=25^\circ C$

■ Test circuit for Output Noise

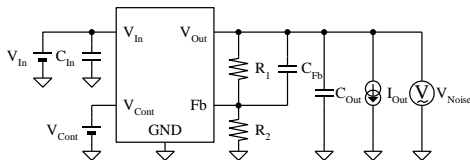

$R_2=36k\Omega$   
 $V_{In}=V_{Out,TYP}+1.0V, V_{Cont}=2.0V, I_{Out}=100mA$   
 $BPF=400Hz \sim 80kHz$   
 $C_{In}=C_{Out}=1.0\mu F(\text{Ceramic}), C_{Fb}=\text{none}, T_a=25^\circ C$

**14. Package**

**■ Outline Dimensions**

(Unit:mm)

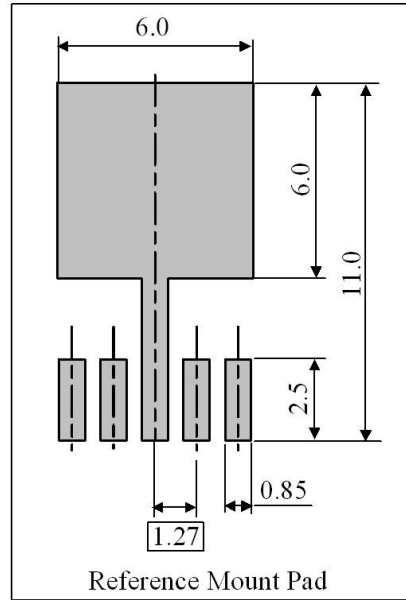
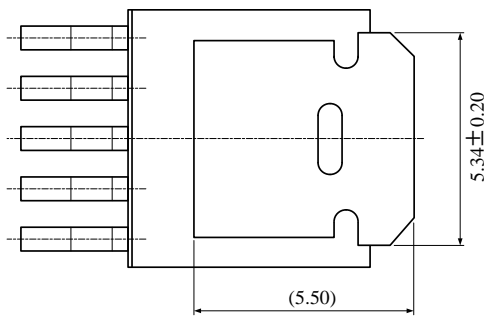
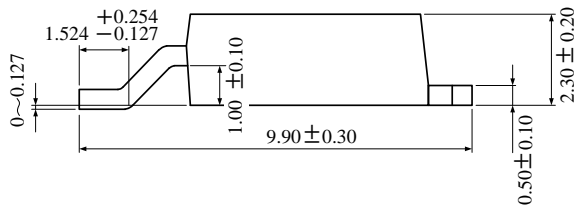
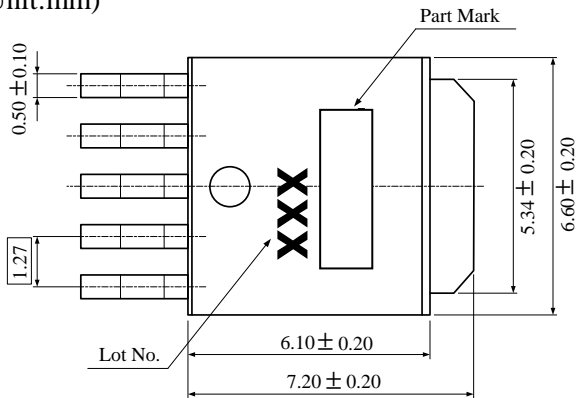

**IMPORTANT NOTICE**

0. Asahi Kasei Microdevices Corporation (“AKM”) reserves the right to make changes to the information contained in this document without notice. When you consider any use or application of AKM product stipulated in this document (“Product”), please make inquiries the sales office of AKM or authorized distributors as to current status of the Products.
1. All information included in this document are provided only to illustrate the operation and application examples of AKM Products. AKM neither makes warranties or representations with respect to the accuracy or completeness of the information contained in this document nor grants any license to any intellectual property rights or any other rights of AKM or any third party with respect to the information in this document. You are fully responsible for use of such information contained in this document in your product design or applications. **AKM ASSUMES NO LIABILITY FOR ANY LOSSES INCURRED BY YOU OR THIRD PARTIES ARISING FROM THE USE OF SUCH INFORMATION IN YOUR PRODUCT DESIGN OR APPLICATIONS.**
2. The Product is neither intended nor warranted for use in equipment or systems that require extraordinarily high levels of quality and/or reliability and/or a malfunction or failure of which may cause loss of human life, bodily injury, serious property damage or serious public impact, including but not limited to, equipment used in nuclear facilities, equipment used in the aerospace industry, medical equipment, equipment used for automobiles, trains, ships and other transportation, traffic signaling equipment, equipment used to control combustions or explosions, safety devices, elevators and escalators, devices related to electric power, and equipment used in finance-related fields. Do not use Product for the above use unless specifically agreed by AKM in writing.
3. Though AKM works continually to improve the Product’s quality and reliability, you are responsible for complying with safety standards and for providing adequate designs and safeguards for your hardware, software and systems which minimize risk and avoid situations in which a malfunction or failure of the Product could cause loss of human life, bodily injury or damage to property, including data loss or corruption.
4. Do not use or otherwise make available the Product or related technology or any information contained in this document for any military purposes, including without limitation, for the design, development, use, stockpiling or manufacturing of nuclear, chemical, or biological weapons or missile technology products (mass destruction weapons). When exporting the Products or related technology or any information contained in this document, you should comply with the applicable export control laws and regulations and follow the procedures required by such laws and regulations. The Products and related technology may not be used for or incorporated into any products or systems whose manufacture, use, or sale is prohibited under any applicable domestic or foreign laws or regulations.
5. Please contact AKM sales representative for details as to environmental matters such as the RoHS compatibility of the Product. Please use the Product in compliance with all applicable laws and regulations that regulate the inclusion or use of controlled substances, including without limitation, the EU RoHS Directive. AKM assumes no liability for damages or losses occurring as a result of noncompliance with applicable laws and regulations.
6. Resale of the Product with provisions different from the statement and/or technical features set forth in this document shall immediately void any warranty granted by AKM for the Product and shall not create or extend in any manner whatsoever, any liability of AKM.
7. This document may not be reproduced or duplicated, in any form, in whole or in part, without prior written consent of AKM.