

**50W Isolated Forward Converter
with Synchronous Rectification**

DESCRIPTION

Demonstration circuit 1174A-A is a 50W Isolated Forward Converter with Synchronous Rectification featuring the LTC3725 / LTC3726.

This circuit was designed to demonstrate the high levels of performance, efficiency, and small solution size attainable using this part in a Resonant-Reset Forward Converter power supply. It operates at 200kHz and produces a regulated 5.0V, 10A output from an input voltage range of 9 to 36V: suitable for automotive, industrial, and other applications. It has an eighth-brick footprint area. Synchronous rectifica-

tion helps to attain efficiency exceeding 90%. Isolation is 1500VDC basic.

Design files for this circuit board are available. Call the LTC factory.

LT, LTC, LTM, LT, Burst Mode, OPTI-LOOP, Over-The-Top and PolyPhase are registered trademarks of Linear Technology Corporation. Adaptive Power, C-Load, DirectSense, Easy Drive, FilterCAD, Hot Swap, LinearView, μ Module, Micropower SwitcherCAD, Multimode Dimming, No Latency $\Delta\Sigma$, No Latency Delta-Sigma, No R_{SENSE} , Operational Filter, PanelProtect, PowerPath, PowerSOT, SmartStart, SoftSpan, Stage Shedding, SwitcherCAD, ThinSOT, UltraFast and VLDO are trademarks of Linear Technology Corporation. Other product names may be trademarks of the companies that manufacture the products.

PERFORMANCE SUMMARY Specifications are at TA = 25°C

SYMBOL	PARAMETER	CONDITIONS	MIN	TYP	MAX	UNITS
V_{IN}	Input Supply Range		9*		36	V
V_{OUT}	Output Voltage			5.0		V
I_{OUT}	Output Current Range	$V_{IN} = 9 - 36V$	0		10	A
F_{SW}	Switching (Clock) Frequency			200		kHz
$V_{OUT\ P-P}$	Output Ripple	$V_{IN} = 18V, I_{OUT} = 10A$ (20MHz BW)		70		mV _{P-P}
I_{REG}	Output Regulation	Line and Load (9-36V, 0-10A)		± 0.2		%
P_{OUT}/P_{IN}	Efficiency (see Figure 3)	$V_{IN} = 18V, I_{OUT} = 6A$		90		%
	Isolation	Basic		1500		V _{dc}
	Size	Component Area x Top Component Height		2.3 x 0.9 x 0.35		Inches

*Typical minimum startup is 9.3V

OPERATING PRINCIPLES

The LTC3725 Single-Switch Forward Controller is used on the primary and provides start-up, gate drive, and protection functions. Once start-up is accomplished, the LTC3726 Secondary-Side Synchronous Forward Controller takes over, and provides the LTC3725 with timing information and bias power through a small pulse transformer.

When input voltage is applied, the LTC3725 commences soft-start of the output voltage. When the secondary bias source reaches the undervoltage threshold, the LTC3726 comes alive and takes control by sending encoded PWM gate pulses to the LTC3725 through T2. These pulses also provide primary bias power efficiently over a wide input voltage range.

The transition from primary to secondary control occurs at a fraction of the nominal output voltage. From then on, operation and design is simplified to that of a simple buck converter. Secondary control eliminates delays, tames large-signal overshoot, and reduces output capacitance needed to meet transient response requirements.

An optional LC filter stage on the input lowers rms input current. The filter must have output impedance that is less than the converter input impedance to assure stability. This may require a damping impedance. (See Linear

Technology Application Note AN19 for a discussion of input filter stability.) A source with a 50mOhm or higher ESR at the filter resonant frequency is one way of providing damping for the filter elements provided on the DC1174A. For bench testing, adding an electrolytic capacitor such as a Sanyo 50ME470AX to the input terminals will provide suitable damping and ripple current capability. The values selected have a filter resonant frequency that is below the converter switching frequency, thus avoiding high circulating currents in the filter.

QUICK START PROCEDURE

Demonstration circuit 1174 is easy to set up to evaluate the performance of the LTC3725 / LTC3726. Refer to Figure 1 for proper measurement equipment setup and follow the procedure below:

NOTE. When measuring the output voltage ripple, care must be taken to avoid a long ground lead on the oscilloscope probe. Measure the output voltage ripple by touching the probe tip and ground ring directly across the last output capacitor as shown in Figure 12.

1. Set an input power supply that is capable of 9V to 36V to 18V. Then turn off the supply.
2. Direct an airflow of 200lfm across the unit for sustained operation at full load.
3. With power off, connect the supply to the input terminals +Vin and -Vin.
 - a. Input voltages lower than 9V can keep the converter from turning on due to the undervoltage lockout feature of the LTC3725 / LTC3726.
 - b. If efficiency measurements are desired, an ammeter capable of measuring 7A_{dc} or a resistor shunt can be put in series with the input supply in order to measure the DC1174A's input current.
 - c. A voltmeter with a capability of measuring at least 36V can be placed across the input terminals in order to get an accurate input voltage measurement.
4. Turn on the power at the input.

NOTE. Make sure that the input voltage never exceeds 36V.

5. Check for the proper output voltage of 5V. Turn off the power at the input.
6. Once the proper output voltages are established, connect a variable load capable of sinking 10A at 5V to the output terminals +V_{out} and -V_{out}. Set the current for 0A.
 - a. If efficiency measurements are desired, an ammeter or a resistor shunt that is capable of handling 10A_{dc} can be put in series with the output load in order to measure the DC1174A's output current.
 - b. A voltmeter with a capability of measuring at least 5V can be placed across the output terminals in order to get an accurate output voltage measurement.
7. Turn on the power at the input.

NOTE. If there is no output, temporarily disconnect the load to make sure that the load is not set too high.
8. Once the proper output voltage is again established, adjust the load within the operating range and observe the output voltage regulation, ripple voltage, efficiency and other desired parameters.

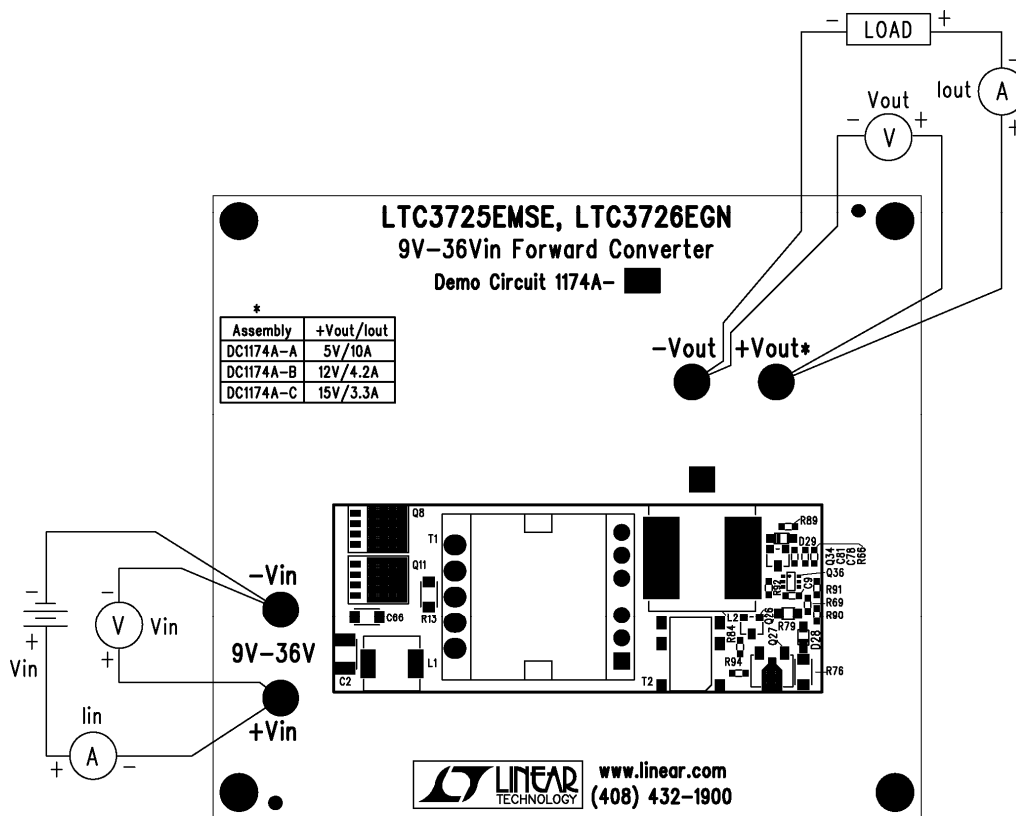

Figure 1. Proper Measurement Equipment Setup

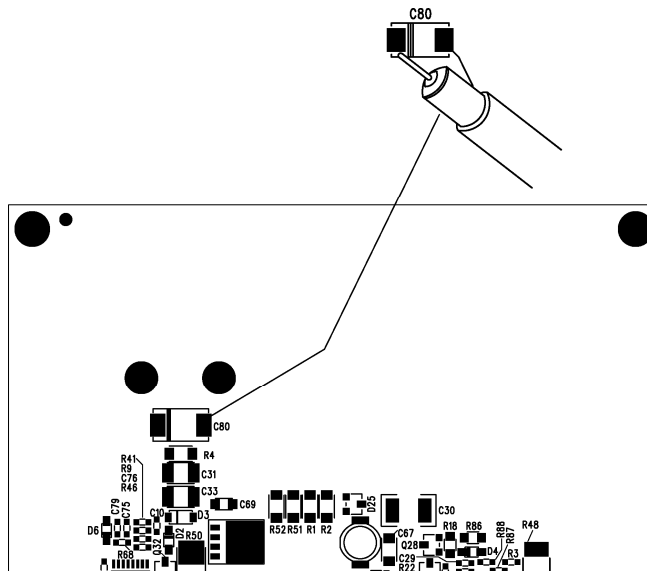

Figure 2. Proper Noise Measurement Setup

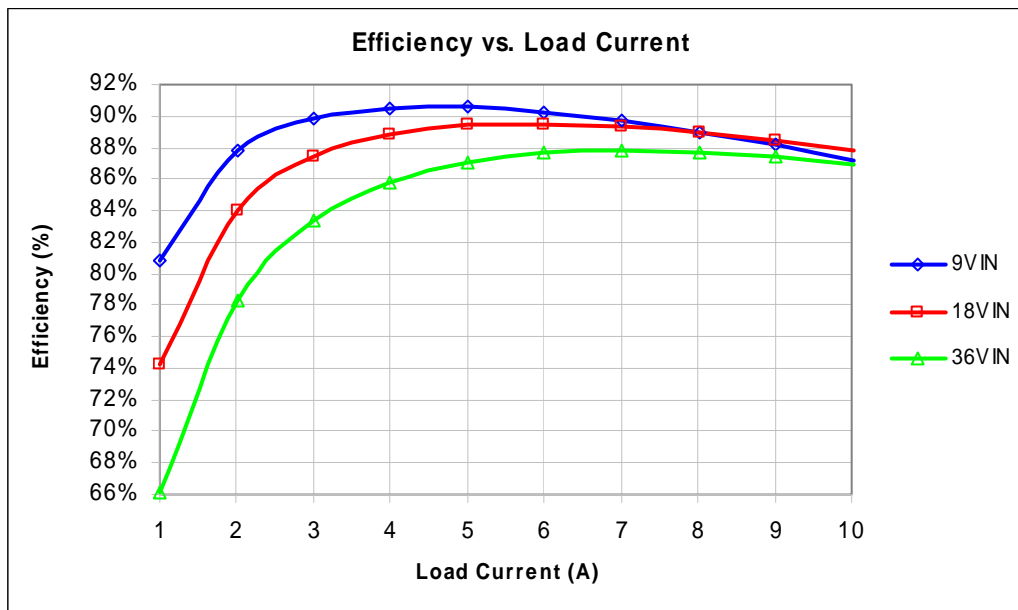

Figure 3. Efficiency

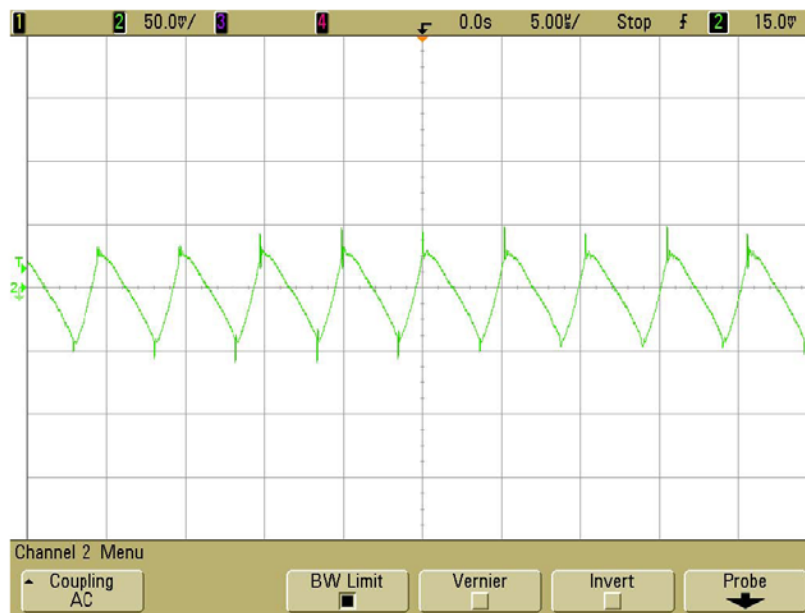

Figure 4. Output Ripple at 18Vin and 10Aout (25MHz) (50mV, 5us / div, 25MHz)

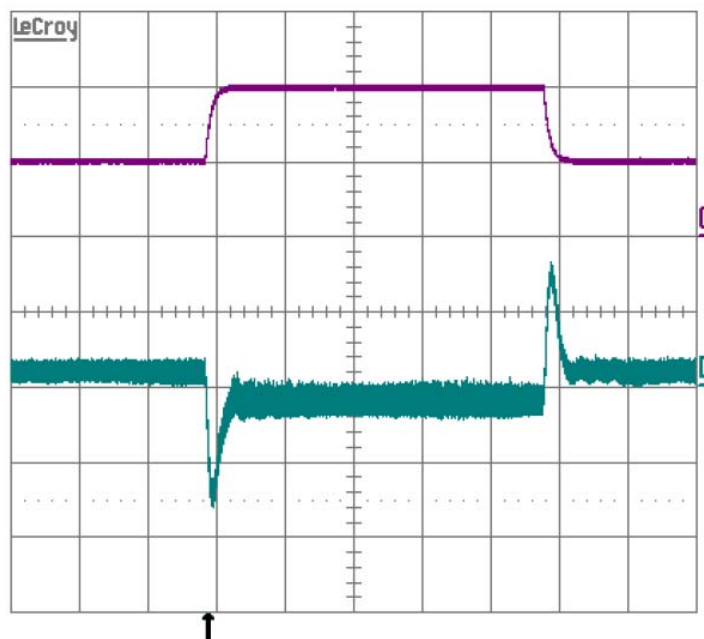

Figure 5. Transient Response Waveform at 18Vin and 5 - 10Aout (5A, 50mV, 200us / div)

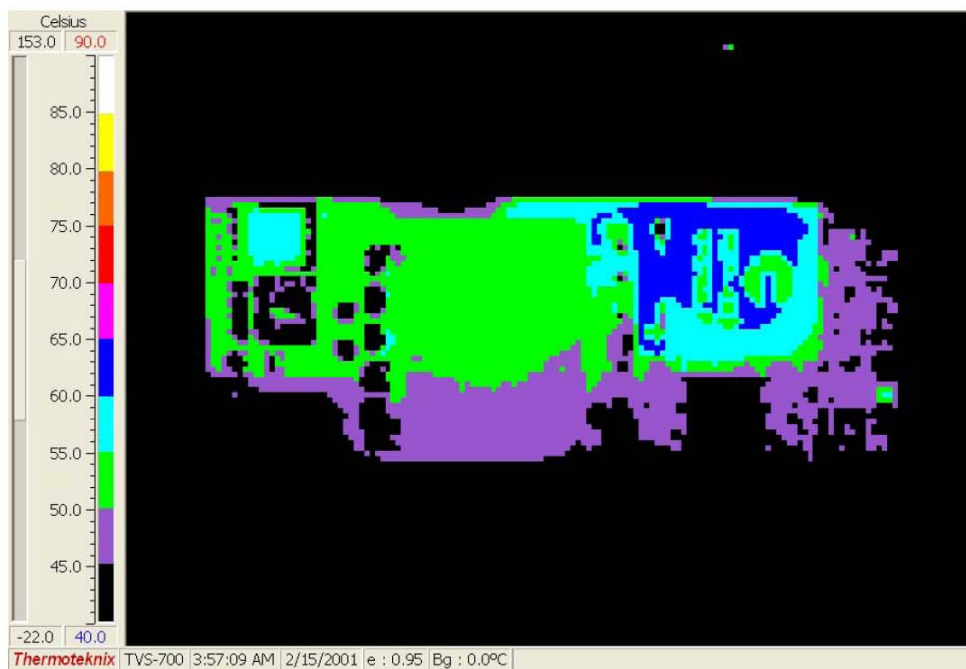
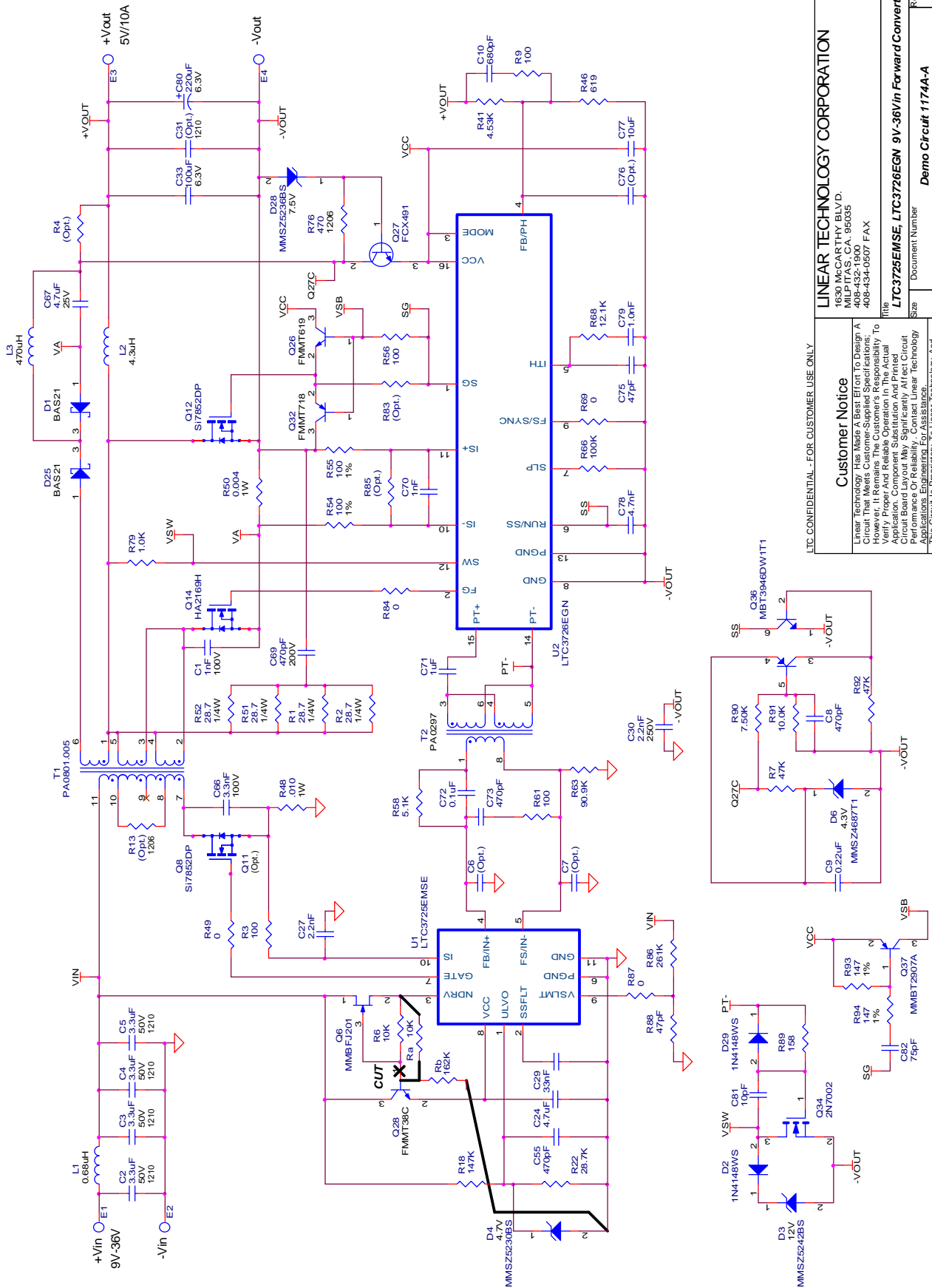

Figure 6. Thermal Map, Frontside at 18Vin and 10Aout (Ta = 25 degrees C)



Figure 7. Thermal Map, Backside at 18Vin and 10Aout (Ta = 25 degrees C)

LTC3725 / LTC3726



LTC CONFIDENTIAL - FOR CUSTOMER USE ONLY

Customer Notice
 Linear Technology Has Made A Best Effort To Design A Circuit That Meets Customer-Supplied Specifications. It Is The Customer's Responsibility To Verify Proper And Reliable Operation In The Actual Application. Component Substitution And Printed Circuit Board Layout May Significantly Affect Circuit Performance Or Reliability. Contact Linear Technology At [Phone Number] For Assistance. This Circuit Is Proprietary To Linear Technology And Supplied For Use With Linear Technology Parts.

LINEAR TECHNOLOGY CORPORATION
 1630 MCCARTHY BLVD.
 MILPITAS, CA. 95035
 408-432-1900
 408-434-0507 FAX

Part: **LTC3725EMSE, LTC3726EGN 9V-36V In Forward Converter**

Document Number: **Demo Circuit 1174A-A**

Rev: **A**

Date: **Friday, August 14, 2009**

Sheet: **1** of **1**

