

# IRF6668

DirectFET™ Power MOSFET ②

- RoHS compliant containing no lead or bromide ①
- Low Profile (<0.7 mm)
- Dual Sided Cooling Compatible ①
- Ultra Low Package Inductance
- Optimized for High Frequency Switching ①
- Ideal for High Performance Isolated Converter Primary Switch Socket
- Optimized for Synchronous Rectification
- Low Conduction Losses
- Compatible with existing Surface Mount Techniques ①

Typical values (unless otherwise specified)

$V_{DS}$	$V_{GS}$	$R_{DS(on)}$	$Q_{g\ tot}$	$Q_{gd}$
80V max	±20V max	12mΩ @ 10V	22nC	7.8nC

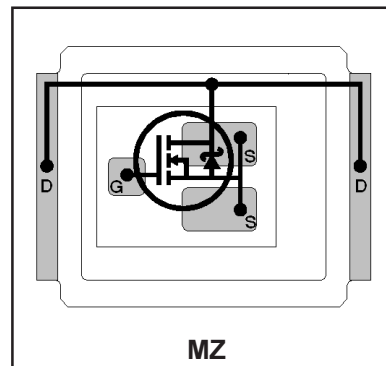

Applicable DirectFET Outline and Substrate Outline (see p.7,8 for details)①

SH	SJ	SP	<b>MZ</b>	MN					
----	----	----	-----------	----	--	--	--	--	--

## Description

The IRF6668 combines the latest HEXFET® power MOSFET silicon technology with advanced DirectFET™ packaging to achieve the lowest on-state resistance in a package that has the footprint of an SO-8 and only 0.7 mm profile. The DirectFET package is compatible with existing layout geometries used in power applications, PCB assembly equipment and vapor phase, infra-red or convection soldering techniques, when application note AN-1035 is followed regarding the manufacturing methods and processes. The DirectFET package allows dual sided cooling to maximize thermal transfer in power systems, improving previous best thermal resistance by 80%.

The IRF6668 is optimized for primary side bridge topologies in isolated DC-DC applications, for 48V(±10%) or 36V-60V ETSI input voltage range systems. The IRF6668 is also ideal for secondary side synchronous rectification in regulated isolated DC-DC topologies. The reduced total losses in the device coupled with the high level of thermal performance enables high efficiency and low temperatures, which are key for system reliability improvements, and makes this device ideal for high performance isolated DC-DC converters.

## Absolute Maximum Ratings

	Parameter	Max.	Units
$V_{DS}$	Drain-to-Source Voltage	80	V
$V_{GS}$	Gate-to-Source Voltage	±20	
$I_D @ T_C = 25^\circ C$	Continuous Drain Current, $V_{GS} @ 10V$ ④	55	A
$I_D @ T_C = 70^\circ C$	Continuous Drain Current, $V_{GS} @ 10V$ ④	44	
$I_{DM}$	Pulsed Drain Current ③	170	
$I_S @ T_C = 25^\circ C$	Continuous Source Current (Body Diode) ④	81	
$I_S @ T_C = 70^\circ C$	Continuous Source Current (Body Diode) ④	52	
$I_{SM}$	Pulsed Source Current (Body Diode)③	170	

Notes:

① Click on this section to link to the appropriate technical paper.

② Click on this section to link to the DirectFET Website.

③ Repetitive rating; pulse width limited by max. junction temperature.

④  $T_C$  measured with thermocouple mounted to top (Drain) of part.

## Electrical Characteristic @ $T_J = 25^\circ\text{C}$ (unless otherwise specified)

	Parameter	Min.	Typ.	Max.	Units	Conditions
$BV_{DSS}$	Drain-to-Source Breakdown Voltage	80	—	—	V	$V_{GS} = 0V, I_D = 250\mu A$
$\Delta BV_{DSS}/\Delta T_J$	Breakdown Voltage Temp. Coefficient	—	0.097	—	V/°C	Reference to $25^\circ\text{C}, I_D = 1\text{mA}$
$R_{DS(on)}$	Static Drain-to-Source On-Resistance	—	12	15	mΩ	$V_{GS} = 10V, I_D = 12A$ ⑤
$V_{GS(th)}$	Gate Threshold Voltage	3.0	4.0	4.9	V	$V_{DS} = V_{GS}, I_D = 100\mu A$
$\Delta V_{GS(th)}/\Delta T_J$	Gate Threshold Voltage Coefficient	—	-11	—	mV/°C	
$I_{DSS}$	Drain-to-Source Leakage Current	—	—	20	μA	$V_{DS} = 80V, V_{GS} = 0V$
		—	—	250		$V_{DS} = 64V, V_{GS} = 0V, T_J = 125^\circ\text{C}$
$I_{GSS}$	Gate-to-Source Forward Leakage	—	—	100	nA	$V_{GS} = 20V$
	Gate-to-Source Reverse Leakage	—	—	-100		$V_{GS} = -20V$
$g_{fs}$	Forward Transconductance	22	—	—	S	$V_{DS} = 10V, I_D = 12A$
$Q_g$	Total Gate Charge	—	22	31	nC	$V_{DS} = 40V$ $V_{GS} = 10V$ $I_D = 12A$ See Fig. 14
$Q_{gs1}$	Pre-Vth Gate-to-Source Charge	—	4.8	—		
$Q_{gs2}$	Post-Vth Gate-to-Source Charge	—	1.6	—		
$Q_{gd}$	Gate-to-Drain Charge	—	7.8	12		
$Q_{godr}$	Gate Charge Overdrive	—	7.8	—		
$Q_{sw}$	Switch Charge ( $Q_{gs2} + Q_{gd}$ )	—	9.4	—		
$Q_{oss}$	Output Charge	—	12	—	nC	$V_{DS} = 16V, V_{GS} = 0V$
$R_G$ (Internal)	Gate Resistance	—	1.0	—	Ω	
$t_{d(on)}$	Turn-On Delay Time	—	19	—	ns	$V_{DD} = 40V, V_{GS} = 10V$ ⑤ $I_D = 12A$ $R_G = 6.2\Omega$ See Fig. 16
$t_r$	Rise Time	—	13	—		
$t_{d(off)}$	Turn-Off Delay Time	—	7.1	—		
$t_f$	Fall Time	—	23	—		
$C_{iss}$	Input Capacitance	—	1320	—	pF	$V_{GS} = 0V$ $V_{DS} = 25V$ $f = 1.0\text{MHz}$ $V_{GS} = 0V, V_{DS} = 1.0V, f = 1.0\text{MHz}$ $V_{GS} = 0V, V_{DS} = 64V, f = 1.0\text{MHz}$
$C_{oss}$	Output Capacitance	—	310	—		
$C_{rss}$	Reverse Transfer Capacitance	—	76	—		
$C_{oss}$	Output Capacitance	—	1400	—		
$C_{oss}$	Output Capacitance	—	200	—		

## Avalanche Characteristics

	Parameter	Min.	Typ.	Max.	Units	Conditions
$E_{AS}$	Single Pulse Avalanche Energy	—	—	24	mJ	$T_J = 25^\circ\text{C}, I_S = 23A, R_G = 25\Omega$ $L = 0.088\text{mH}$ . See Fig. 13

## Diode Characteristics

	Parameter	Min.	Typ.	Max.	Units	Conditions
$V_{SD}$	Diode Forward Voltage	—	—	1.3	V	$T_J = 25^\circ\text{C}, I_S = 12A, V_{GS} = 0V$ ⑤
$t_{rr}$	Reverse Recovery Time	—	34	51	ns	$T_J = 25^\circ\text{C}, I_F = 12A, V_{DD} = 40V$
$Q_{rr}$	Reverse Recovery Charge	—	40	60	nC	$di/dt = 100A/\mu s$ ⑤

### Notes:

⑤ Pulse width  $\leq 400\mu s$ ; duty cycle  $\leq 2\%$ .

**Absolute Maximum Ratings**

	Parameter	Max.	Units
$P_D @ T_A = 25^\circ\text{C}$	Power Dissipation ⑥	2.8	W
$P_D @ T_A = 70^\circ\text{C}$	Power Dissipation ⑥	1.8	
$P_D @ T_C = 25^\circ\text{C}$	Power Dissipation ④	89	
$T_P$	Peak Soldering Temperature	270	°C
$T_J$	Operating Junction and	-40 to +150	
$T_{STG}$	Storage Temperature Range		

**Thermal Resistance**

	Parameter	Typ.	Max.	Units
$R_{\theta JA}$	Junction-to-Ambient ⑥⑧	—	45	°C/W
$R_{\theta JA}$	Junction-to-Ambient ⑦⑧	12.5	—	
$R_{\theta JC}$	Junction-to-Case ④⑧	—	1.4	
$R_{\theta J-PCB}$	Junction-to-PCB Mounted	1.0	—	

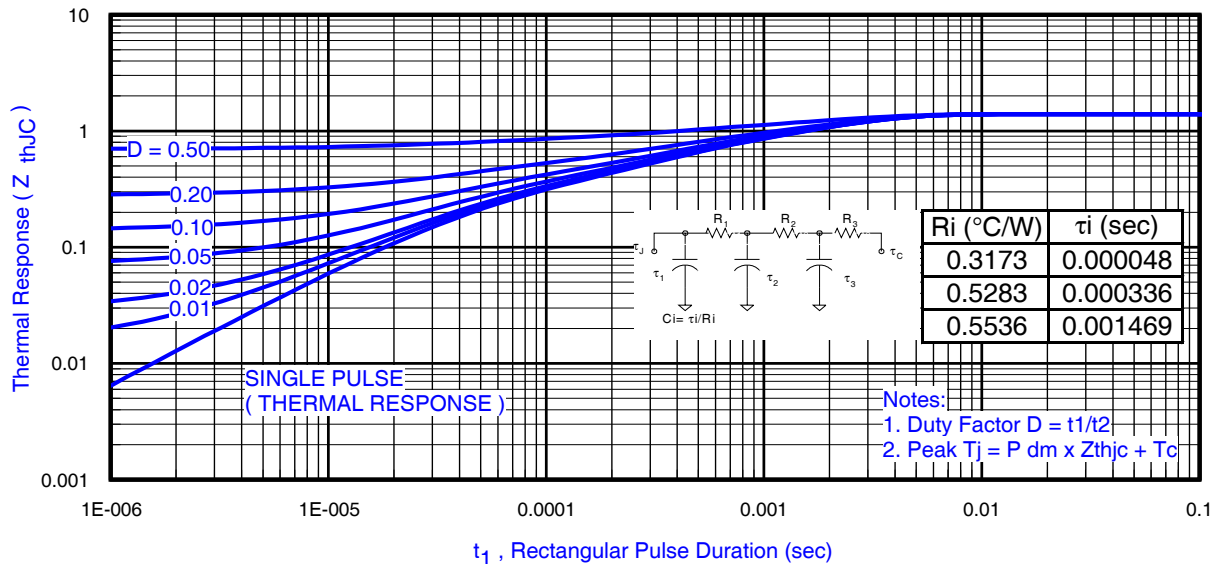

**Fig 1.** Maximum Effective Transient Thermal Impedance, Junction-to-Case ①

**Notes:**

- ⑥ Surface mounted on 1 in. square Cu, steady state (still air).
- ⑦ Used double sided cooling, mounted on 1 in. square Cu board PCB with small clip heatsink (still air).
- ⑧  $R_{\theta}$  is measured at  $T_J$  of approximately  $90^\circ\text{C}$ .



Note ⑥

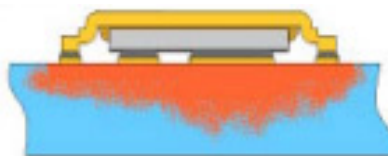

Note ⑦



Note ⑦

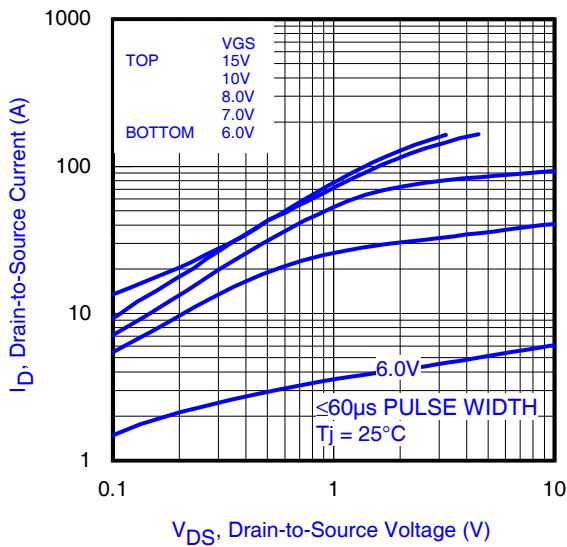

**Fig 2.** Typical Output Characteristics

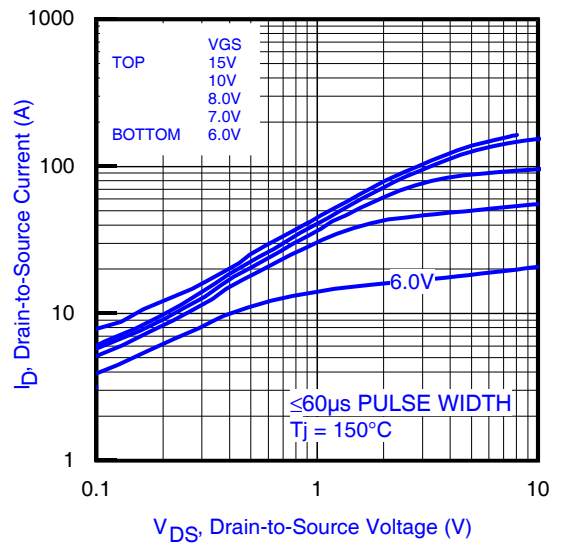

**Fig 3.** Typical Output Characteristics

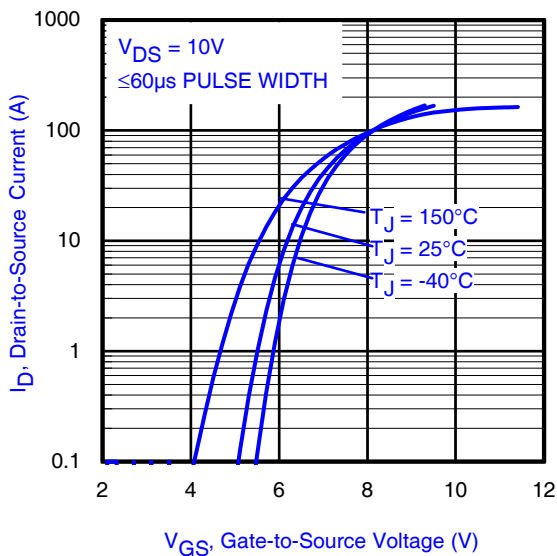

**Fig 4.** Typical Transfer Characteristics

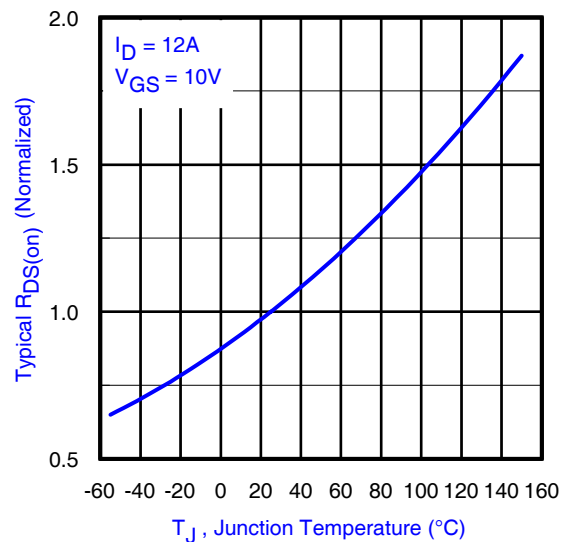

**Fig 5.** Normalized On-Resistance vs. Temperature

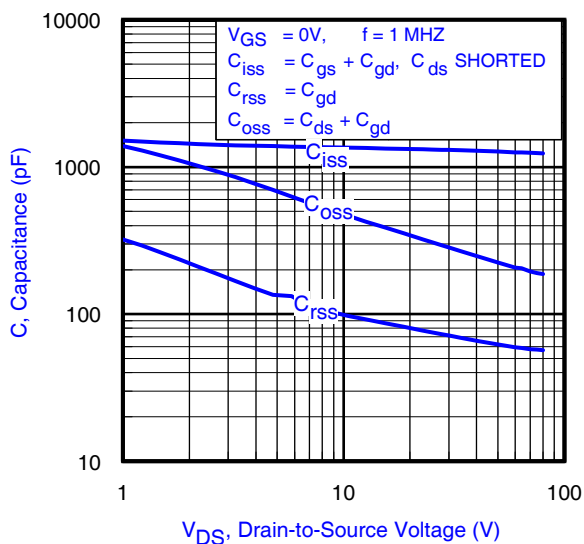

**Fig 6.** Typical Capacitance vs. Drain-to-Source Voltage

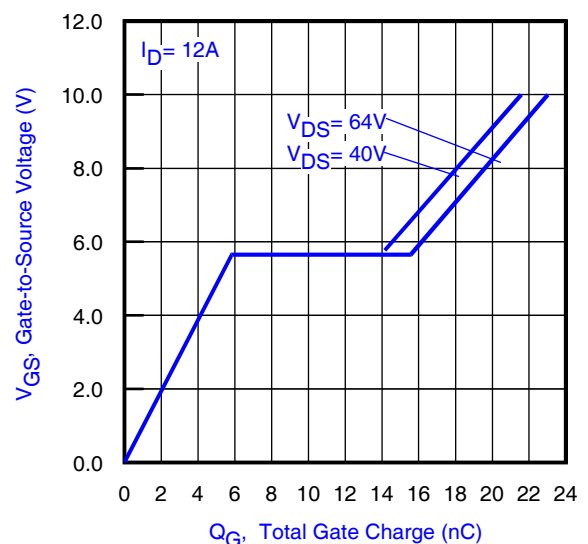

**Fig 7.** Typical Total Gate Charge vs. Gate-to-Source Voltage

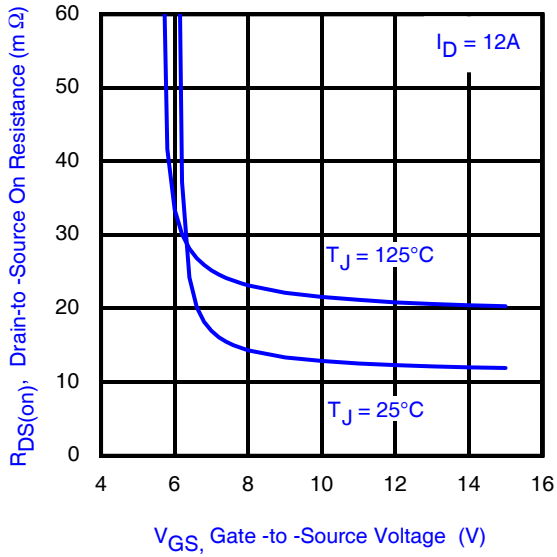

**Fig 8.** Typical On-Resistance vs. Gate Voltage

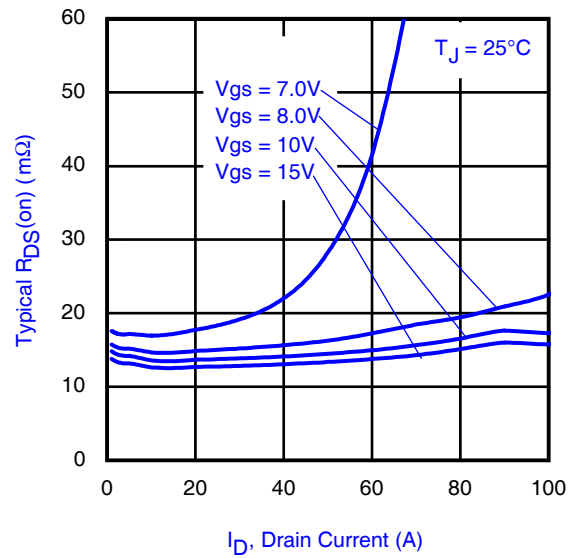

**Fig 9.** Typical On-Resistance vs. Drain Current

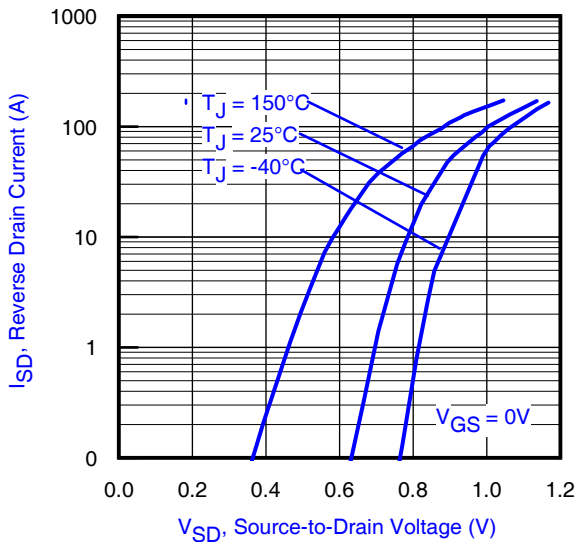

**Fig 10.** Typical Source-Drain Diode Forward Voltage

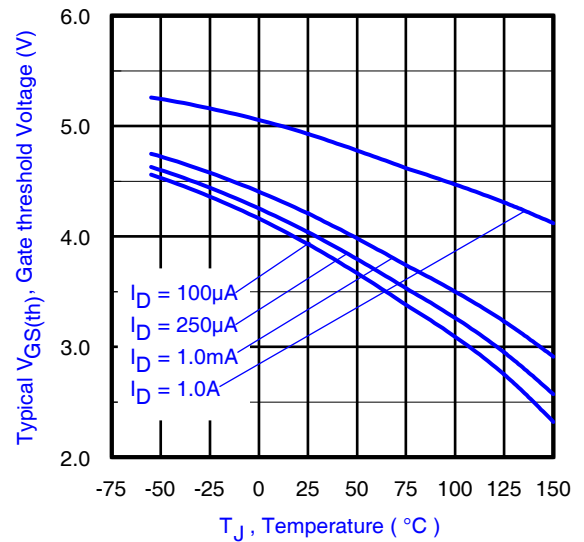

**Fig 11.** Typical Threshold Voltage vs. Junction Temperature

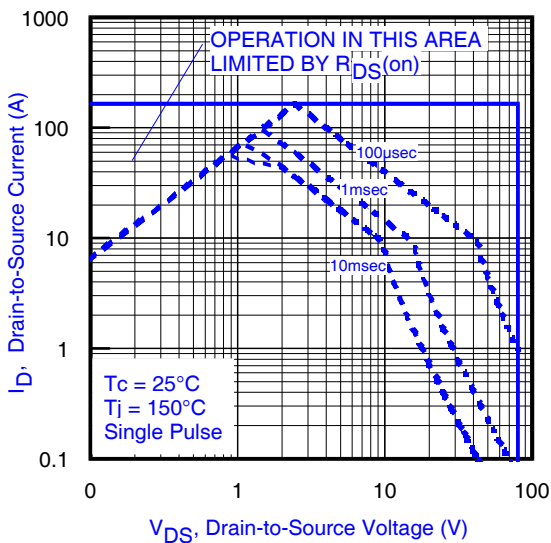

**Fig12.** Maximum Safe Operating Area

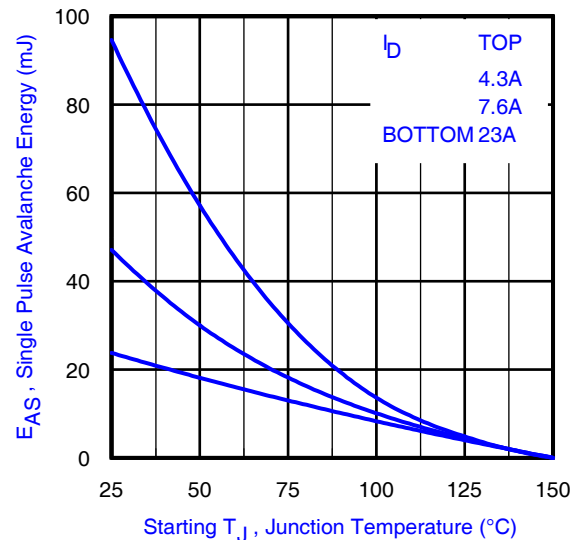

**Fig 13.** Maximum Avalanche Energy vs. Drain Current

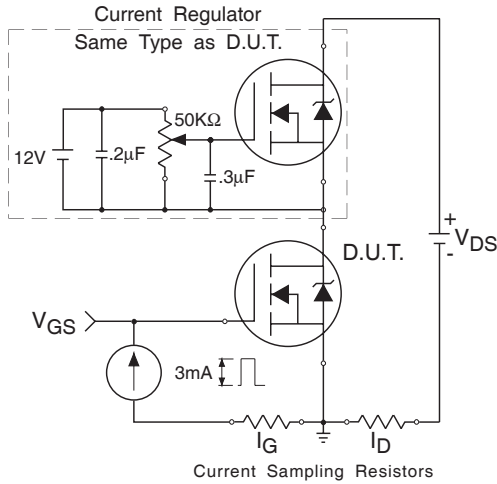

**Fig 14a.** Gate Charge Test Circuit

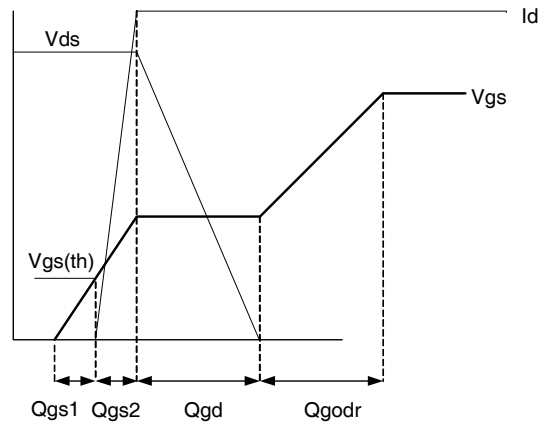

**Fig 14b.** Gate Charge Waveform

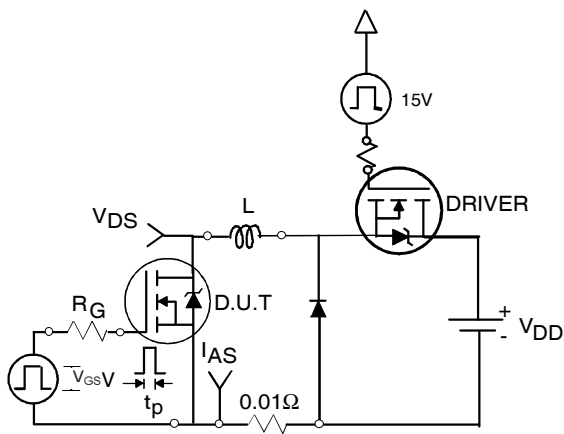

**Fig 15a.** Unclamped Inductive Test Circuit

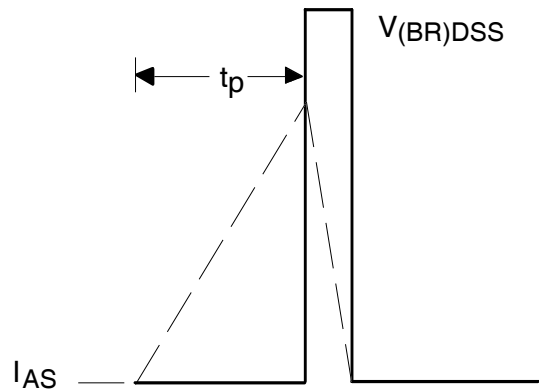

**Fig 15b.** Unclamped Inductive Waveforms

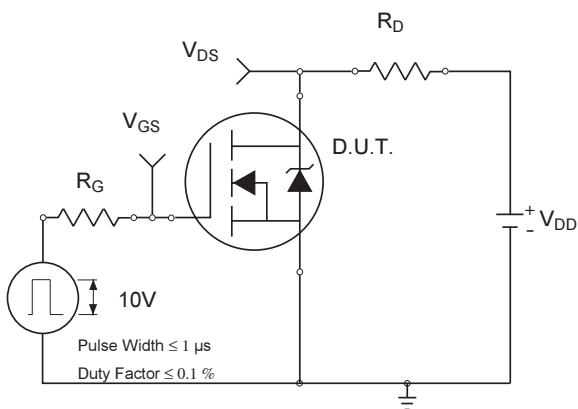

**Fig 16a.** Switching Time Test Circuit

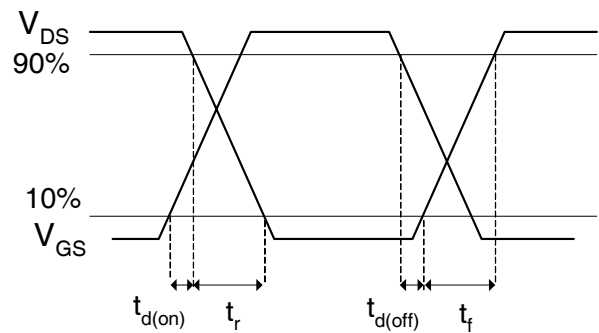

**Fig 16b.** Switching Time Waveforms

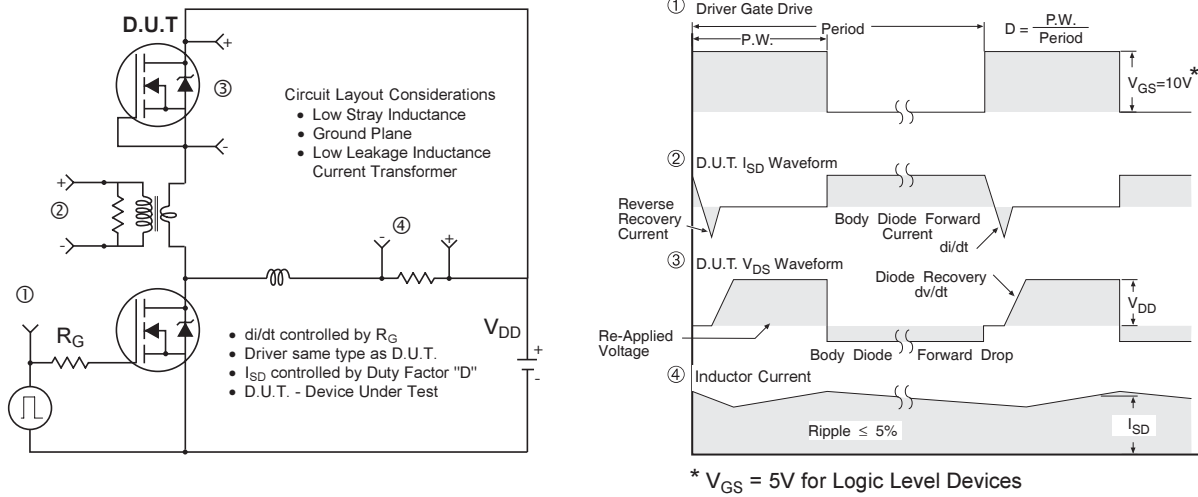
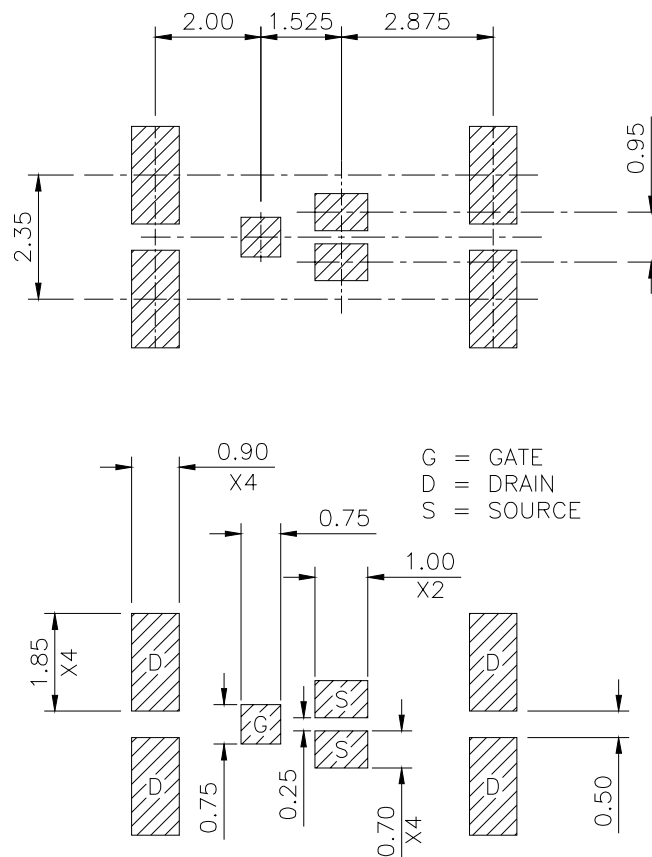

**Fig 17.** Diode Reverse Recovery Test Circuit for N-Channel HEXFET® Power MOSFETs

### DirectFET™ Substrate and PCB Layout, MZ Outline (Medium Size Can, Z-Designation).

Please see DirectFET application note AN-1035 for all details regarding the assembly of DirectFET.

This includes all recommendations for stencil and substrate designs.



# IRF6668

## DirectFET™ Outline Dimension, MZ Outline (Medium Size Can, Z-Designation).

Please see DirectFET application note AN-1035 for all details regarding the assembly of DirectFET.

This includes all recommendations for stencil and substrate designs.

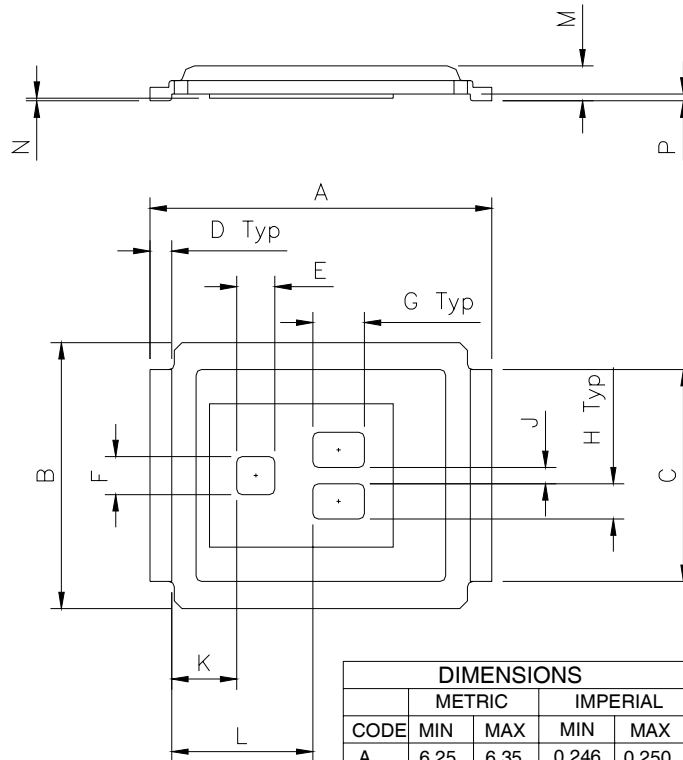

NOTE:  
All dimensions are absolute  
& are for Application  
guidance/reference only.

CODE	METRIC		IMPERIAL	
	MIN	MAX	MIN	MAX
A	6.25	6.35	0.246	0.250
B	4.80	5.05	0.189	0.201
C	3.85	3.95	0.152	0.156
D	0.35	0.45	0.014	0.018
E	0.68	0.72	0.027	0.028
F	0.68	0.72	0.027	0.028
G	0.93	0.97	0.037	0.038
H	0.63	0.67	0.025	0.026
J	0.28	0.32	0.011	0.013
K	1.13	1.26	0.044	0.050
L	2.53	2.66	0.100	0.105
M	0.59	0.70	0.023	0.028
N	0.03	0.08	0.001	0.003
P	0.08	0.17	0.003	0.007

## DirectFET™ Part Marking

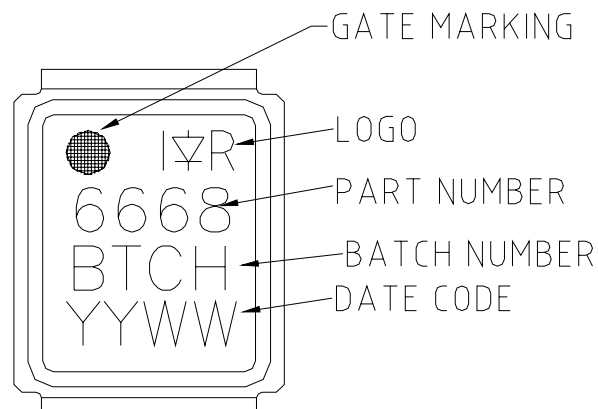



DirectFET™ Tape & Reel Dimension (Showing component orientation).

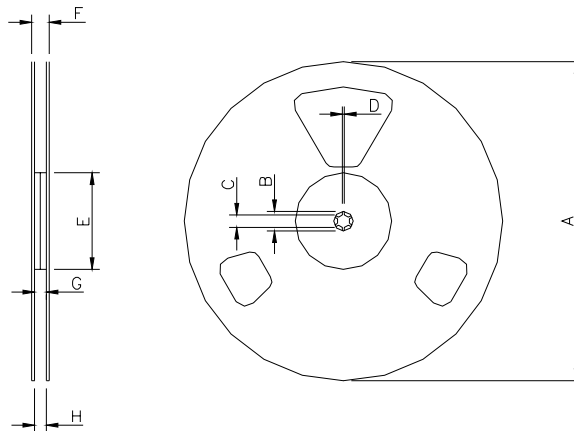

NOTE: Controlling dimensions in mm  
 Std reel quantity is 4800 parts. (ordered as IRF6668). For 1000 parts on 7" reel,  
 order IRF6668TR1

REEL DIMENSIONS								
CODE	STANDARD OPTION (QTY 4800)				TR1 OPTION (QTY 1000)			
	METRIC		IMPERIAL		METRIC		IMPERIAL	
A	330.0	N.C	12.992	N.C	177.77	N.C	6.9	N.C
B	20.2	N.C	0.795	N.C	19.06	N.C	0.75	N.C
C	12.8	13.2	0.504	0.520	13.5	12.8	0.53	0.50
D	1.5	N.C	0.059	N.C	1.5	N.C	0.059	N.C
E	100.0	N.C	3.937	N.C	58.72	N.C	2.31	N.C
F	N.C	18.4	N.C	0.724	N.C	13.50	N.C	0.53
G	12.4	14.4	0.488	0.567	11.9	12.01	0.47	N.C
H	11.9	15.4	0.469	0.606	11.9	12.01	0.47	N.C

LOADED TAPE FEED DIRECTION

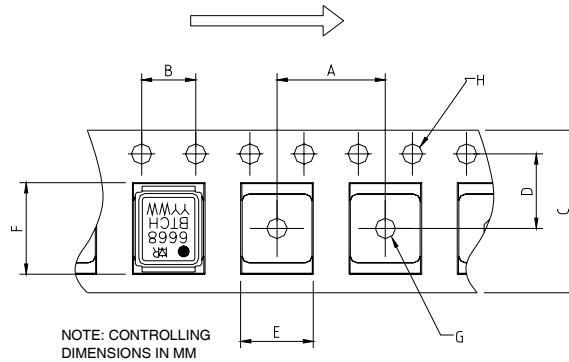

NOTE: CONTROLLING DIMENSIONS IN MM

CODE	DIMENSIONS			
	METRIC		IMPERIAL	
A	7.90	8.10	0.311	0.319
B	3.90	4.10	0.154	0.161
C	11.90	12.30	0.469	0.484
D	5.45	5.55	0.215	0.219
E	5.10	5.30	0.201	0.209
F	6.50	6.70	0.256	0.264
G	1.50	N.C	0.059	N.C
H	1.50	1.60	0.059	0.063

Data and specifications subject to change without notice.  
 This product has been designed and qualified for the Consumer market.  
 Qualification Standards can be found on IR's Web site.

Note: For the most current drawings please refer to the IR website at:  
<http://www.irf.com/package/>