

RF Power LDMOS Transistor

N-Channel Enhancement-Mode Lateral MOSFET

Designed for wideband defense, industrial and commercial applications with frequencies up to 1000 MHz. The high gain and broadband performance of this device are ideal for large-signal, common-source amplifier applications in 28 V RF systems.

- Typical Single-Carrier N-CDMA Performance @ 880 MHz, $V_{DD} = 28$ Vdc, $I_{DQ} = 450$ mA, $P_{out} = 14$ W Avg., IS-95 CDMA (Pilot, Sync, Paging, Traffic Codes 8 Through 13) Channel Bandwidth = 1.2288 MHz. PAR = 9.8 dB @ 0.01% Probability on CCDF.
Power Gain — 21.1 dB
Drain Efficiency — 33%
ACPR @ 750 kHz Offset — -45.7 dBc in 30 kHz Channel Bandwidth
- Capable of Handling 10:1 VSWR, @ 32 Vdc, 880 MHz, 3 dB Overdrive, Designed for Enhanced Ruggedness

GSM EDGE Application

- Typical GSM EDGE Performance: $V_{DD} = 28$ Vdc, $I_{DQ} = 500$ mA, $P_{out} = 21$ W Avg., Full Frequency Band (920-960 MHz)
Power Gain — 20 dB
Drain Efficiency — 46%
Spectral Regrowth @ 400 kHz Offset = -62 dBc
Spectral Regrowth @ 600 kHz Offset = -78 dBc
EVM — 1.5% rms

GSM Application

- Typical GSM Performance: $V_{DD} = 28$ Vdc, $I_{DQ} = 500$ mA, $P_{out} = 60$ W, Full Frequency Band (920-960 MHz)
Power Gain — 20 dB
Drain Efficiency — 63%

Features

- Characterized with Series Equivalent Large-Signal Impedance Parameters
- Integrated ESD Protection
- 225°C Capable Plastic Package
- In Tape and Reel. R1 Suffix = 500 Units, 24 mm Tape Width, 13-inch Reel.

MMRF1315NR1

**500-1000 MHz, 60 W CW, 28 V
BROADBAND
RF POWER LDMOS TRANSISTOR**

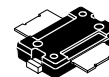

**TO-270-2
PLASTIC**

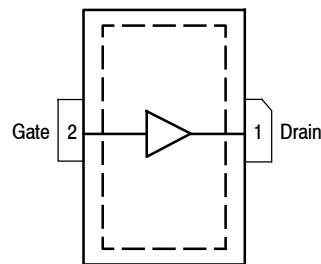

(Top View)

Note: The backside of the package is the source terminal for the transistor.

Figure 1. Pin Connections

Table 1. Maximum Ratings

Rating	Symbol	Value	Unit
Drain-Source Voltage	V_{DSS}	-0.5, +66	Vdc
Gate-Source Voltage	V_{GS}	-0.5, +12	Vdc
Maximum Operation Voltage	V_{DD}	32, +0	Vdc
Storage Temperature Range	T_{stg}	-65 to +150	°C
Case Operating Temperature	T_C	150	°C
Operating Junction Temperature (1,2)	T_J	225	°C

Table 2. Thermal Characteristics

Characteristic	Symbol	Value (2,3)	Unit
Thermal Resistance, Junction to Case Case Temperature 80°C, 60 W CW Case Temperature 78°C, 14 W CW	$R_{\theta JC}$	0.77 0.88	°C/W

1. Continuous use at maximum temperature will affect MTTF.
2. MTTF calculator available at <http://www.freescale.com/rf>. Select Tools (Software & Tools)/Calculators to access MTTF calculators by product.
3. Refer to AN1955, *Thermal Measurement Methodology of RF Power Amplifiers*. Go to <http://www.freescale.com/rf>. Select Documentation/Application Notes - AN1955.

Table 3. ESD Protection Characteristics

Test Methodology	Class
Human Body Model (per JESD22-A114)	1B
Machine Model (per EIA/JESD22-A115)	A
Charge Device Model (per JESD22-C101)	IV

Table 4. Moisture Sensitivity Level

Test Methodology	Rating	Package Peak Temperature	Unit
Per JESD 22-A113, IPC/JEDEC J-STD-020	3	260	°C

Table 5. Electrical Characteristics ($T_C = 25^\circ\text{C}$ unless otherwise noted)

Characteristic	Symbol	Min	Typ	Max	Unit
----------------	--------	-----	-----	-----	------

Off Characteristics

Zero Gate Voltage Drain Leakage Current ($V_{DS} = 66\text{ Vdc}$, $V_{GS} = 0\text{ Vdc}$)	I_{DSS}	—	—	10	μAdc
Zero Gate Voltage Drain Leakage Current ($V_{DS} = 28\text{ Vdc}$, $V_{GS} = 0\text{ Vdc}$)	I_{DSS}	—	—	1	μAdc
Gate-Source Leakage Current ($V_{GS} = 5\text{ Vdc}$, $V_{DS} = 0\text{ Vdc}$)	I_{GSS}	—	—	10	μAdc

On Characteristics

Gate Threshold Voltage ($V_{DS} = 10\text{ Vdc}$, $I_D = 200\ \mu\text{A}$)	$V_{GS(th)}$	1	2.2	3	Vdc
Gate Quiescent Voltage ($V_{DD} = 28\text{ Vdc}$, $I_D = 450\text{ mAdc}$, Measured in Functional Test)	$V_{GS(Q)}$	2	3	4	Vdc
Drain-Source On-Voltage ($V_{GS} = 10\text{ Vdc}$, $I_D = 1.5\text{ Adc}$)	$V_{DS(on)}$	0.05	0.27	0.4	Vdc

Dynamic Characteristics

Reverse Transfer Capacitance ($V_{DS} = 28\text{ Vdc} \pm 30\text{ mV(rms)ac}$ @ 1 MHz, $V_{GS} = 0\text{ Vdc}$)	C_{rss}	—	1.1	—	pF
Output Capacitance ($V_{DS} = 28\text{ Vdc} \pm 30\text{ mV(rms)ac}$ @ 1 MHz, $V_{GS} = 0\text{ Vdc}$)	C_{oss}	—	33	—	pF
Input Capacitance ($V_{DS} = 28\text{ Vdc}$, $V_{GS} = 0\text{ Vdc} \pm 30\text{ mV(rms)ac}$ @ 1 MHz)	C_{iss}	—	109	—	pF

Functional Tests (In Freescale Test Fixture, 50 ohm system) $V_{DD} = 28\text{ Vdc}$, $I_{DQ} = 450\text{ mA}$, $P_{out} = 14\text{ W Avg.}$, $f = 880\text{ MHz}$, Single-Carrier N-CDMA, 1.2288 MHz Channel Bandwidth Carrier. ACPR measured in 30 kHz Channel Bandwidth @ $\pm 750\text{ kHz}$ Offset. PAR = 9.8 dB @ 0.01% Probability on CCDF

Power Gain	G_{ps}	20	21.1	23	dB
Drain Efficiency	η_D	30.5	33	—	%
Adjacent Channel Power Ratio	ACPR	—	-45.7	-44	dBc
Input Return Loss	IRL	—	-18	-9	dB

(continued)

Table 5. Electrical Characteristics ($T_C = 25^\circ\text{C}$ unless otherwise noted) (continued)

Characteristic	Symbol	Min	Typ	Max	Unit
----------------	--------	-----	-----	-----	------

Typical GSM EDGE Performances (In Freescale GSM EDGE Test Fixture Optimized for 920–960 MHz, 50 ohm system) $V_{DD} = 28\text{ Vdc}$, $I_{DQ} = 500\text{ mA}$, $P_{out} = 21\text{ W Avg.}$, $f = 920\text{--}960\text{ MHz}$, GSM EDGE Signal

Power Gain	G_{ps}	—	20	—	dB
Drain Efficiency	η_D	—	46	—	%
Error Vector Magnitude	EVM	—	1.5	—	%
Spectral Regrowth at 400 kHz Offset	SR1	—	-62	—	dBc
Spectral Regrowth at 600 kHz Offset	SR2	—	-78	—	dBc

Typical CW Performances (In Freescale GSM Test Fixture Optimized for 920–960 MHz, 50 ohm system) $V_{DD} = 28\text{ Vdc}$, $I_{DQ} = 500\text{ mA}$, $P_{out} = 60\text{ W}$, $f = 920\text{--}960\text{ MHz}$

Power Gain	G_{ps}	—	20	—	dB
Drain Efficiency	η_D	—	63	—	%
Input Return Loss	IRL	—	-12	—	dB
P_{out} @ 1 dB Compression Point ($f = 940\text{ MHz}$)	P1dB	—	67	—	W

Typical Performances (In Freescale Test Fixture, 50 ohm system) $V_{DD} = 28\text{ Vdc}$, $I_{DQ} = 450\text{ mA}$, 865–900 MHz Bandwidth

Video Bandwidth @ 60 W PEP P_{out} where $IM3 = -30\text{ dBc}$ (Tone Spacing from 100 kHz to VBW) $\Delta IMD3 = IMD3$ @ VBW frequency - $IMD3$ @ 100 kHz <1 dBc (both sidebands)	VBW	—	3	—	MHz
Gain Flatness in 35 MHz Bandwidth @ $P_{out} = 14\text{ W Avg.}$	G_F	—	0.27	—	dB
Gain Variation over Temperature (-30°C to $+85^\circ\text{C}$)	ΔG	—	0.011	—	dB/ $^\circ\text{C}$
Output Power Variation over Temperature (-30°C to $+85^\circ\text{C}$)	$\Delta P1dB$	—	0.088	—	dBm/ $^\circ\text{C}$

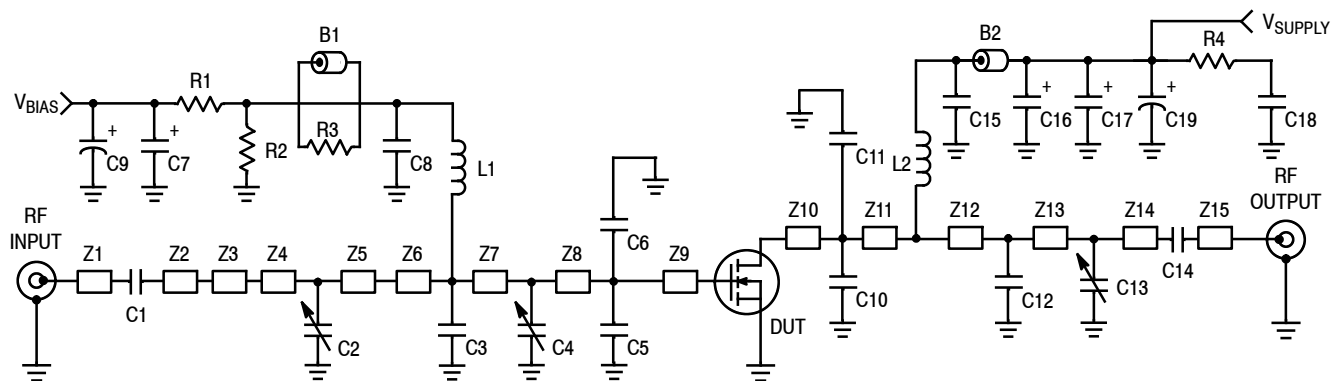

Z1	0.215" x 0.065" Microstrip	Z9	0.057" x 0.525" Microstrip
Z2	0.221" x 0.065" Microstrip	Z10	0.360" x 0.270" Microstrip
Z3	0.500" x 0.100" Microstrip	Z11	0.063" x 0.270" Microstrip
Z4	0.460" x 0.270" Microstrip	Z12	0.360" x 0.065" Microstrip
Z5	0.040" x 0.270" Microstrip	Z13	0.170" x 0.065" Microstrip
Z6	0.280" x 0.270" x 0.530" Taper	Z14	0.880" x 0.065" Microstrip
Z7	0.087" x 0.525" Microstrip	Z15	0.260" x 0.065" Microstrip
Z8	0.435" x 0.525" Microstrip	PCB	Taconic RF-35 0.030", $\epsilon_r = 3.5$

Figure 2. MMRF1315NR1 Test Circuit Schematic

Table 6. MMRF1315NR1 Test Circuit Component Designations and Values

Part	Description	Part Number	Manufacturer
B1	Ferrite Bead	2743019447	Fair Rite
B2	Ferrite Bead	274021447	Fair Rite
C1, C8, C14, C15	47 pF Chip Capacitors	ATC100B470JT500XT	ATC
C2, C4, C13	0.8–8.0 pF Variable Capacitors, Gigatrim	2729152	Johanson
C3	3.0 pF Chip Capacitor	ATC100B3R0JT500XT	ATC
C5, C6	15 pF Chip Capacitors	ATC100B150JT500XT	ATC
C7, C16, C17	10 μ F, 35 V Tantalum Capacitors	T491D106K035AT	Kemet
C9	100 μ F, 50 V Electrolytic Capacitor	MCHT101M1HB-1017-RH	Multicomp
C10, C11	12 pF Chip Capacitors	ATC100B120JT500XT	ATC
C12	4.3 pF Chip Capacitor	ATC100B4R3JT500XT	ATC
C18	0.56 μ F Chip Capacitor	ATC700A561MT150XT	ATC
C19	470 μ F, 63 V Electrolytic Capacitor	EKME630ELL471MK255	Multicomp
L1, L2	12.5 nH Inductor	A04T-5	Coilcraft
R1	1 k Ω , 1/4 W Chip Resistor	CRCW12061001FKEA	Vishay
R2	560 k Ω , 1/4 W Chip Resistor	CRCW12065600FKEA	Vishay
R3	12 Ω , 1/4 W Chip Resistor	CRCW120612R0FKEA	Vishay
R4	27 Ω , 1/4 W Chip Resistor	CRCW120627R0FKEA	Vishay

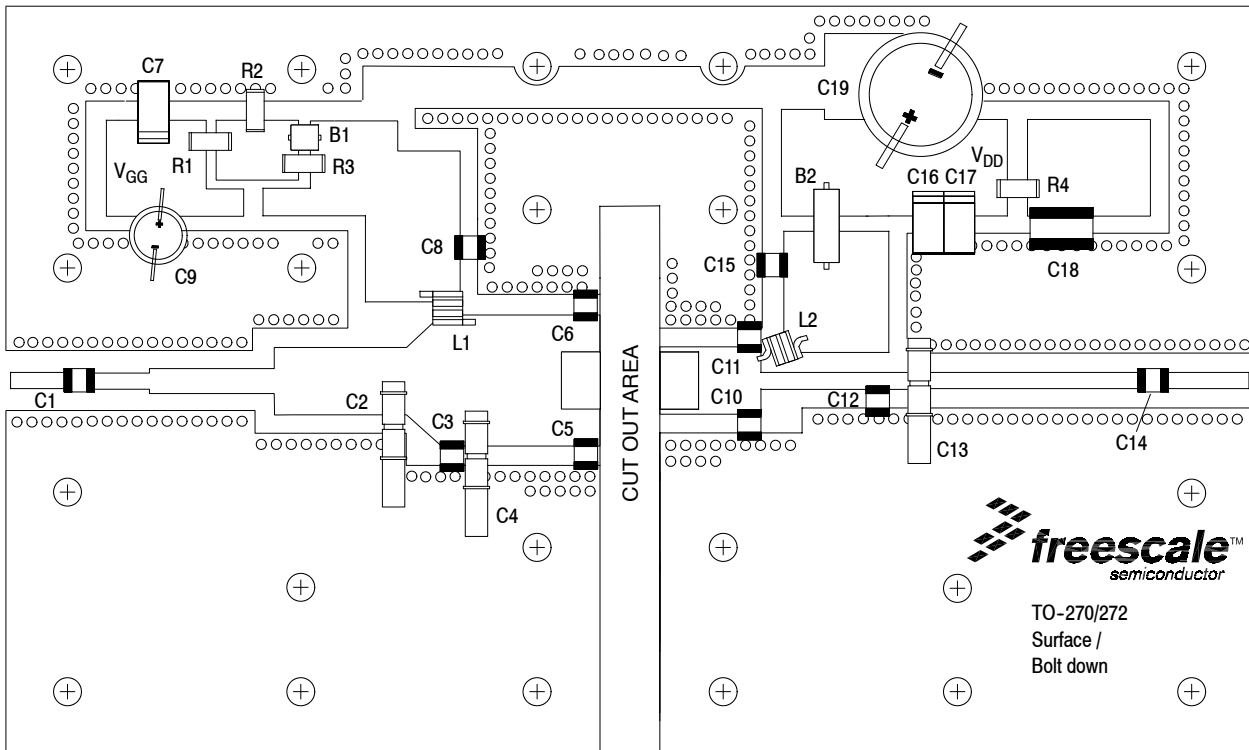

Figure 3. MMRF1315NR1 Test Circuit Component Layout

TYPICAL CHARACTERISTICS

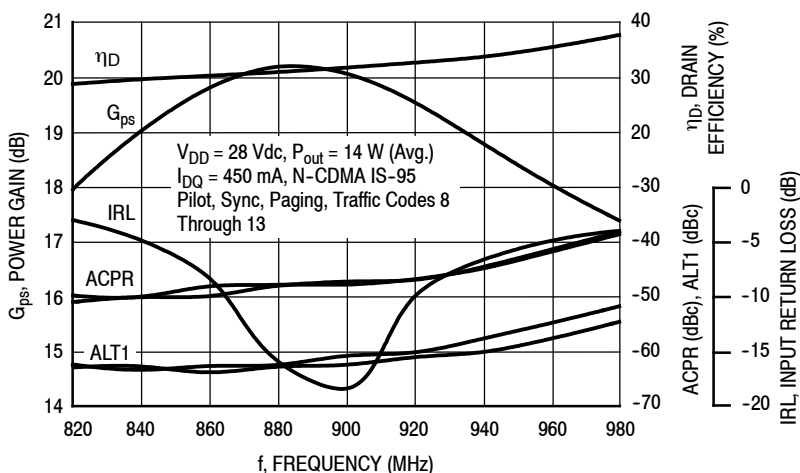

Figure 4. Single-Carrier N-CDMA Broadband Performance @ $P_{out} = 14$ Watts Avg.

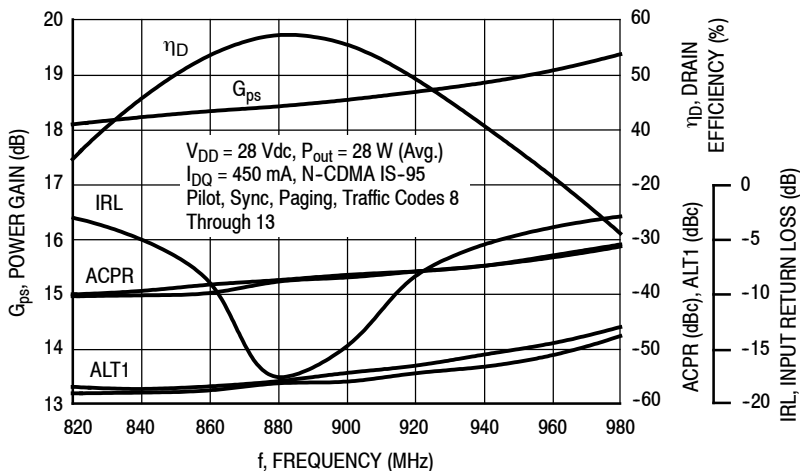

Figure 5. Single-Carrier N-CDMA Broadband Performance @ $P_{out} = 28$ Watts Avg.

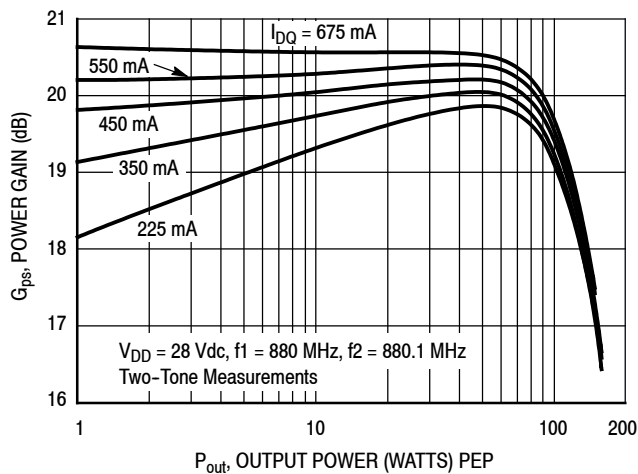

Figure 6. Two-Tone Power Gain versus Output Power

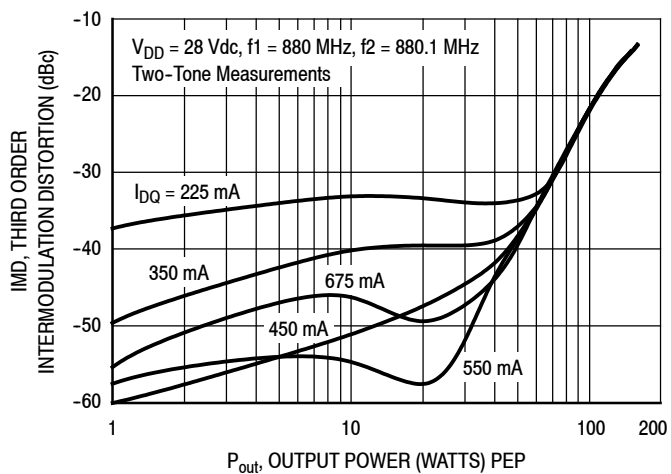

Figure 7. Third Order Intermodulation Distortion versus Output Power

TYPICAL CHARACTERISTICS

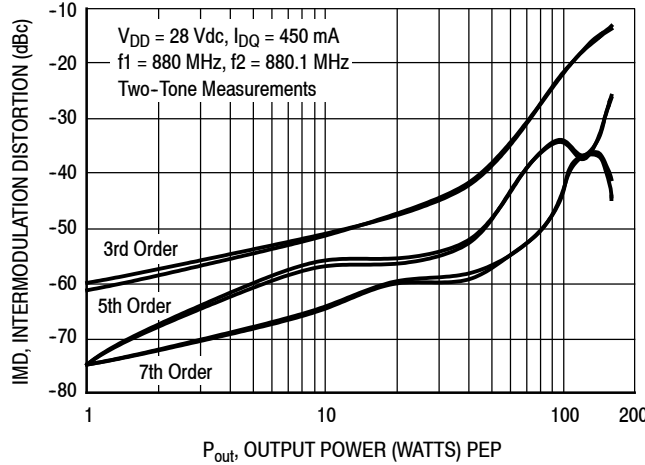

Figure 8. Intermodulation Distortion Products versus Output Power

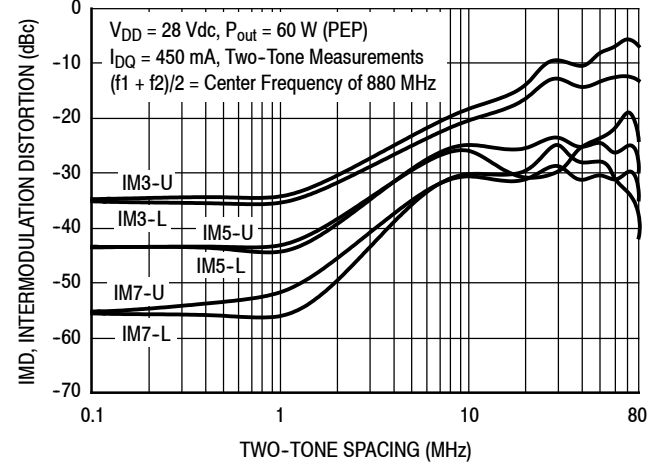

Figure 9. Intermodulation Distortion Products versus Tone Spacing

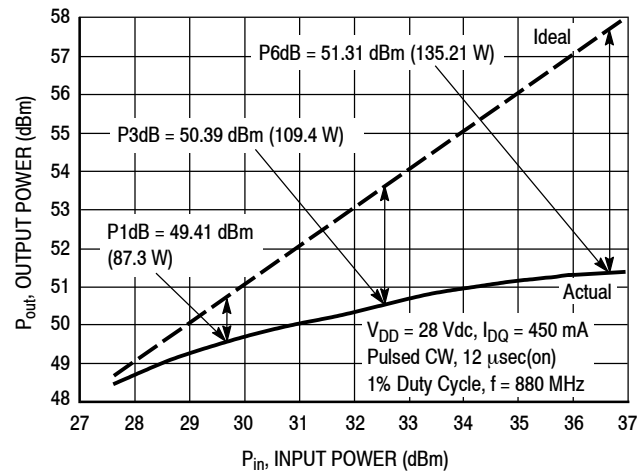

Figure 10. Pulsed CW Output Power versus Input Power

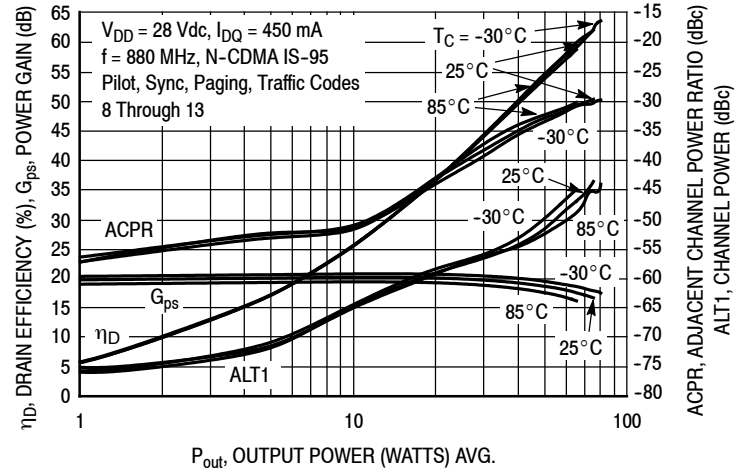

Figure 11. Single-Carrier N-CDMA ACPR, ALT1, Power Gain and Drain Efficiency versus Output Power

TYPICAL CHARACTERISTICS

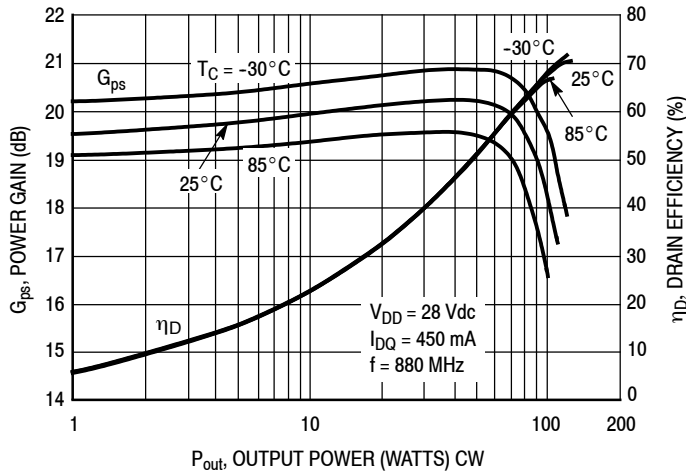

Figure 12. Power Gain and Drain Efficiency versus CW Output Power

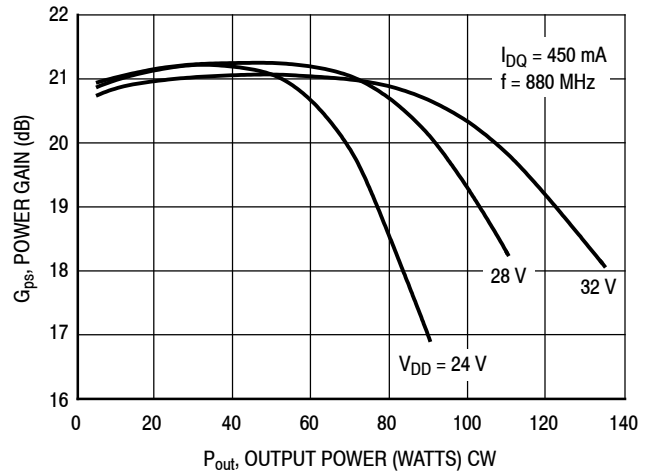
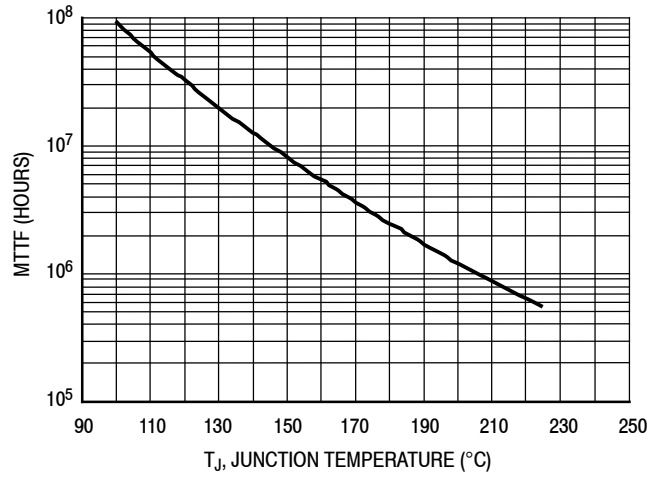

Figure 13. Power Gain versus Output Power



This above graph displays calculated MTTF in hours when the device is operated at $V_{DD} = 28 \text{ Vdc}$, $P_{out} = 14 \text{ W Avg.}$, and $\eta_D = 32.5\%$.

MTTF calculator available at <http://www.freescale.com/rf>. Select Tools (Software & Tools)/Calculators to access MTTF calculators by product.

Figure 14. MTTF versus Junction Temperature

N-CDMA TEST SIGNAL

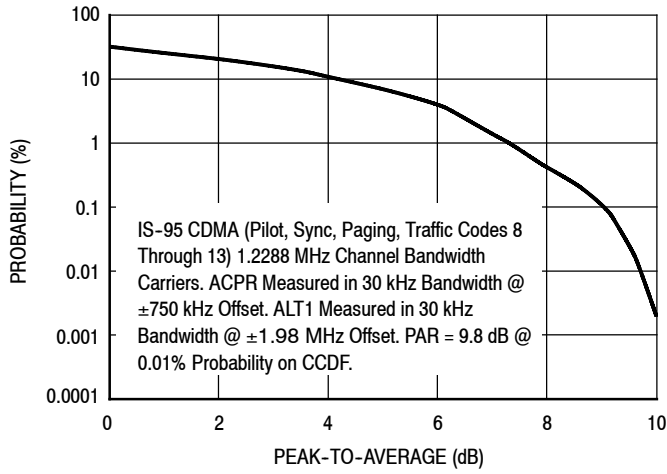

Figure 15. Single-Carrier CCDF N-CDMA

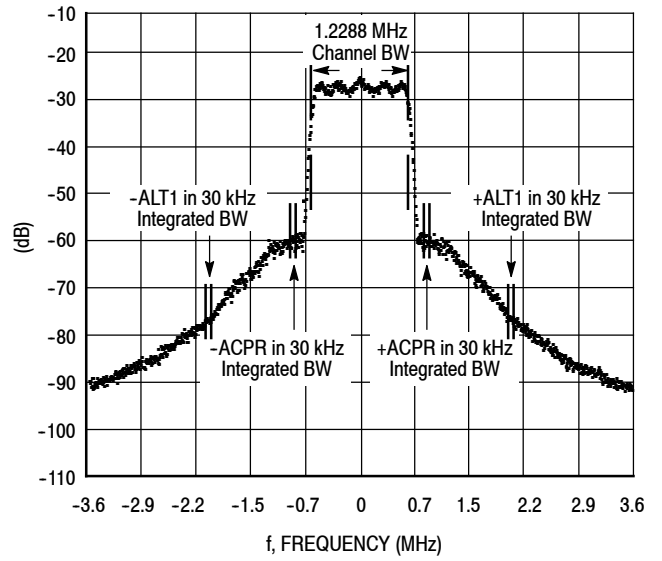
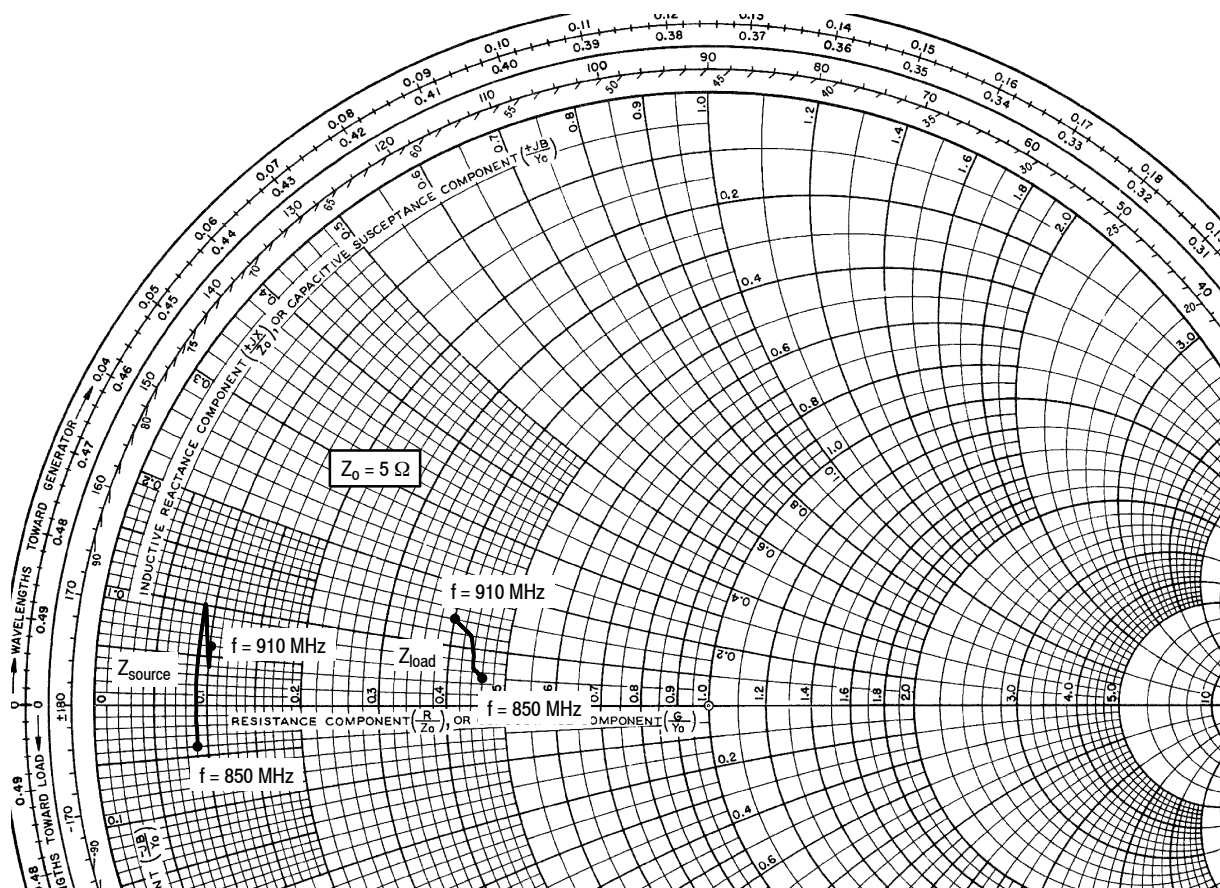

Figure 16. Single-Carrier N-CDMA Spectrum



$V_{DD} = 28 \text{ Vdc}$, $I_{DQ} = 450 \text{ mA}$, $P_{out} = 14 \text{ W Avg.}$

f MHz	Z_{source} Ω	Z_{load} Ω
850	$0.44 - j0.20$	$2.28 + j0.23$
865	$0.44 - j0.07$	$2.18 + j0.33$
880	$0.45 + j0.50$	$2.20 + j0.47$
895	$0.48 + j0.18$	$2.15 + j0.61$
910	$0.52 + j0.29$	$2.00 + j0.68$

Z_{source} = Test circuit impedance as measured from gate to ground.

Z_{load} = Test circuit impedance as measured from drain to ground.

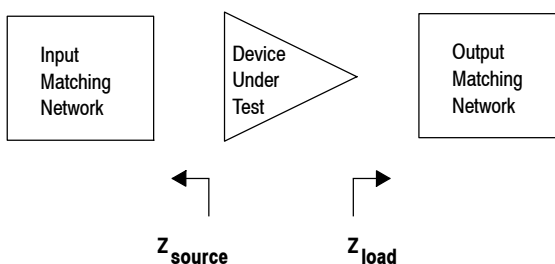
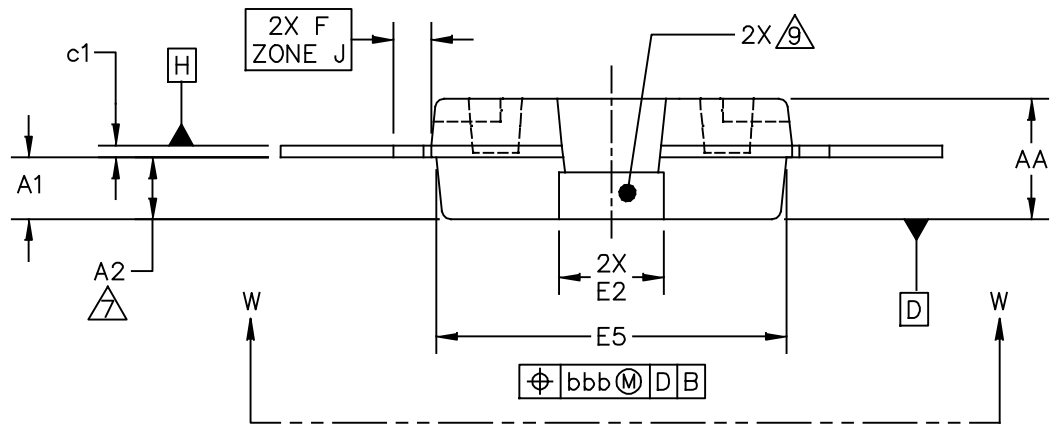
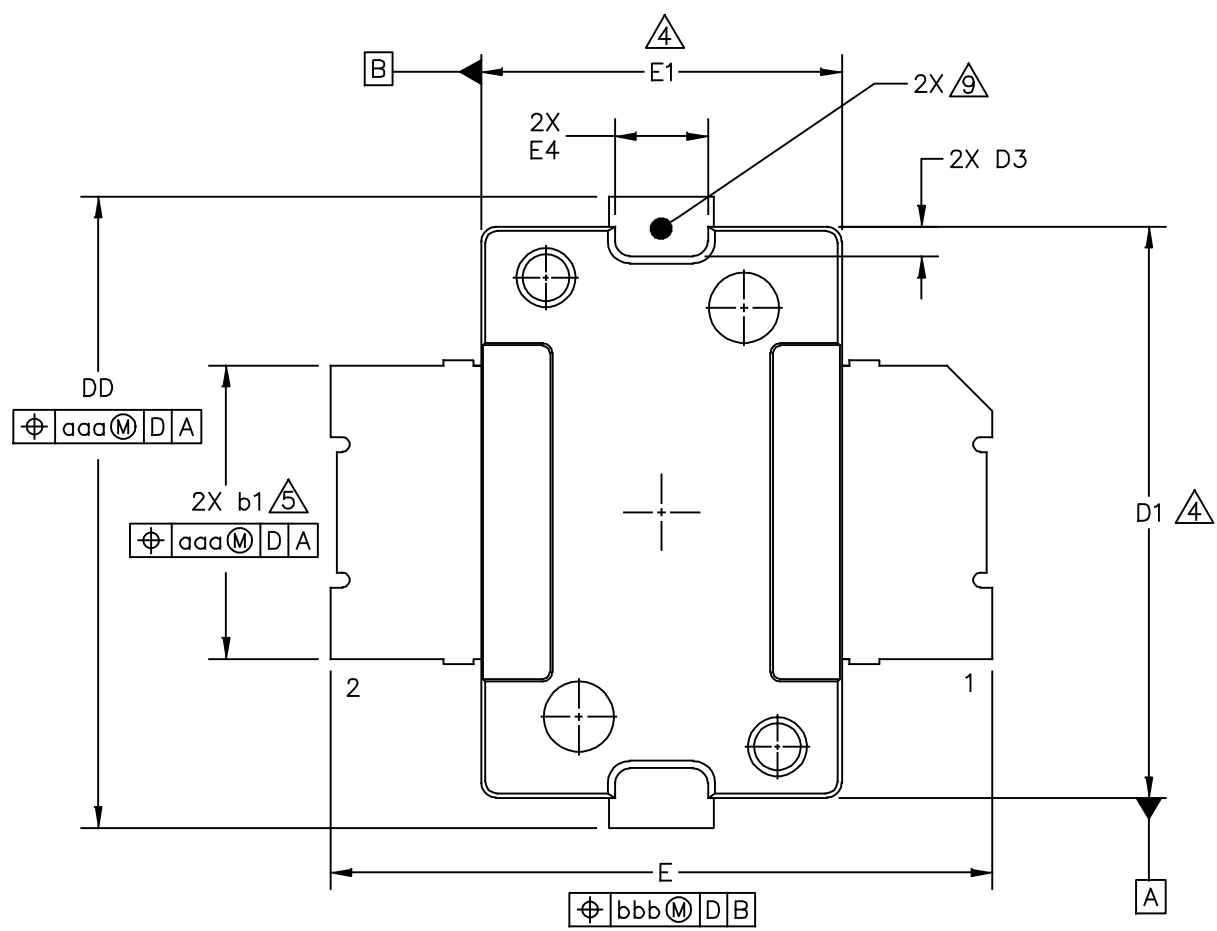
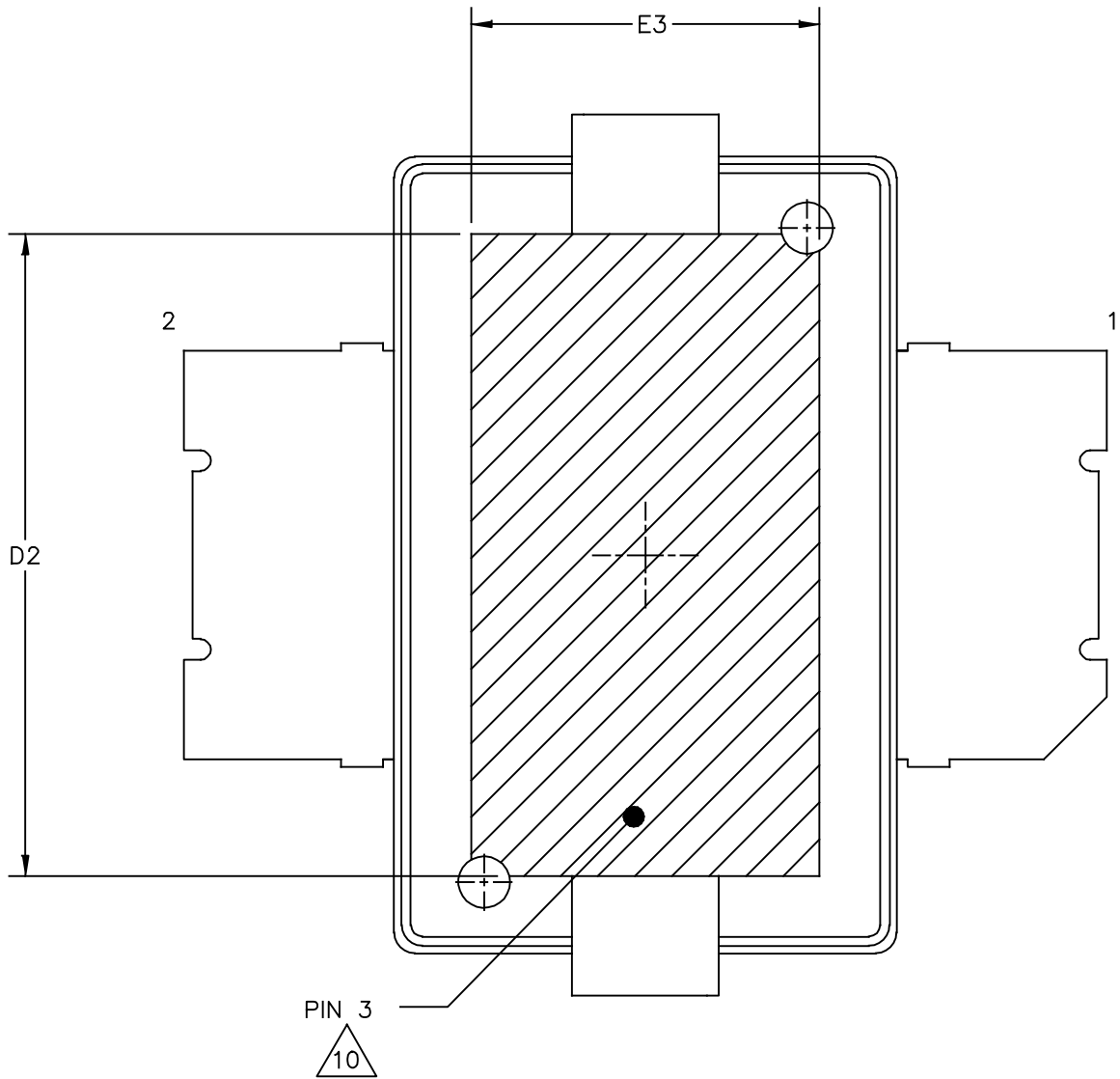

Figure 17. Series Equivalent Source and Load Impedance

PACKAGE DIMENSIONS



© FREESCALE SEMICONDUCTOR, INC. ALL RIGHTS RESERVED.	MECHANICAL OUTLINE	PRINT VERSION NOT TO SCALE
TITLE: TO-270-2	DOCUMENT NO: 98ASH98117A REV: P	STANDARD: NON-JEDEC
	02 JUN 2014	



VIEW W-W
BOTTOM VIEW

© FREESCALE SEMICONDUCTOR, INC. ALL RIGHTS RESERVED.	MECHANICAL OUTLINE	PRINT VERSION NOT TO SCALE
TITLE: TO-270-2	DOCUMENT NO: 98ASH98117A	REV: P
	STANDARD: NON-JEDEC	
	02 JUN 2014	

NOTES:

1. CONTROLLING DIMENSION: INCH
2. INTERPRET DIMENSIONS AND TOLERANCES PER ASME Y14.5M-1994.
3. DATUM PLANE H IS LOCATED AT TOP OF LEAD AND IS COINCIDENT WITH THE LEAD WHERE THE LEAD EXITS THE PLASTIC BODY AT THE TOP OF THE PARTING LINE.
4. DIMENSIONS D1 AND E1 DO NOT INCLUDE MOLD PROTRUSION. ALLOWABLE PROTRUSION IS .006 INCH (0.15 MM) PER SIDE. DIMENSIONS D1 AND E1 DO INCLUDE MOLD MISMATCH AND ARE DETERMINED AT DATUM PLANE H.
5. DIMENSION b1 DOES NOT INCLUDE DAMBAR PROTRUSION. ALLOWABLE DAMBAR PROTRUSION SHALL BE .005 INCH (0.13 MM) TOTAL IN EXCESS OF THE b1 DIMENSION AT MAXIMUM MATERIAL CONDITION.
6. DATUMS A AND B TO BE DETERMINED AT DATUM PLANE H.
7. DIMENSION A2 APPLIES WITHIN ZONE J ONLY.
8. DIMENSIONS DD AND E2 DO NOT INCLUDE MOLD PROTRUSION. OVERALL LENGTH INCLUDING MOLD PROTRUSION SHOULD NOT EXCEED 0.430 INCH (10.92 MM) FOR DIMENSION DD AND 0.080 INCH (2.03 MM) FOR DIMENSION E2. DIMENSIONS DD AND E2 DO INCLUDE MOLD MISMATCH AND ARE DETERMINED AT DATUM PLANE D.
9. THESE SURFACES OF THE HEAT SLUG ARE NOT PART OF THE SOLDERABLE SURFACES AND MAY REMAIN UNPLATED.
10. HATCHING REPRESENTS THE EXPOSED AREA OF THE HEAT SLUG. DIMENSIONS D2 AND E3 REPRESENT THE VALUES BETWEEN THE TWO OPPOSITE POINTS ALONG THE EDGES OF EXPOSED AREA OF THE HEAT SLUG.

DIM	INCH		MILLIMETER		DIM	INCH		MILLIMETER	
	MIN	MAX	MIN	MAX		MIN	MAX	MIN	MAX
AA	.078	.082	1.98	2.08	E4	.058	.066	1.47	1.68
A1	.039	.043	0.99	1.09	E5	.231	.235	5.87	5.97
A2	.040	.042	1.02	1.07	F	.025 BSC		0.64 BSC	
DD	.416	.424	10.57	10.77	b1	.193	.199	4.90	5.06
D1	.378	.382	9.60	9.70	c1	.007	.011	0.18	0.28
D2	.290	----	7.37	----	aaa	.004		0.10	
D3	.016	.024	0.41	0.61	bbb	.008		0.20	
E	.436	.444	11.07	11.28					
E1	.238	.242	6.04	6.15					
E2	.066	.074	1.68	1.88					
E3	.150	----	3.81	----					

© FREESCALE SEMICONDUCTOR, INC. ALL RIGHTS RESERVED.		MECHANICAL OUTLINE		PRINT VERSION NOT TO SCALE			
TITLE: TO-270-2			DOCUMENT NO: 98ASH98117A		REV: P		
			STANDARD: NON-JEDEC				
						02 JUN 2014	

PRODUCT DOCUMENTATION AND SOFTWARE

Refer to the following resources to aid your design process.

Application Notes

- AN1907: Solder Reflow Attach Method for High Power RF Devices in Over-Molded Plastic Packages
- AN1955: Thermal Measurement Methodology of RF Power Amplifiers

Engineering Bulletins

- EB212: Using Data Sheet Impedances for RF LDMOS Devices

Software

- Electromigration MTF Calculator

For Software, do a Part Number search at <http://www.freescale.com>, and select the “Part Number” link. Go to the Software & Tools tab on the part’s Product Summary page to download the respective tool.

REVISION HISTORY

The following table summarizes revisions to this document.

Revision	Date	Description
0	July 2014	• Initial Release of Data Sheet

How to Reach Us:

Home Page:
freescale.com

Web Support:
freescale.com/support

Information in this document is provided solely to enable system and software implementers to use Freescale products. There are no express or implied copyright licenses granted hereunder to design or fabricate any integrated circuits based on the information in this document.

Freescale reserves the right to make changes without further notice to any products herein. Freescale makes no warranty, representation, or guarantee regarding the suitability of its products for any particular purpose, nor does Freescale assume any liability arising out of the application or use of any product or circuit, and specifically disclaims any and all liability, including without limitation consequential or incidental damages. "Typical" parameters that may be provided in Freescale data sheets and/or specifications can and do vary in different applications, and actual performance may vary over time. All operating parameters, including "typicals," must be validated for each customer application by customer's technical experts. Freescale does not convey any license under its patent rights nor the rights of others. Freescale sells products pursuant to standard terms and conditions of sale, which can be found at the following address: freescale.com/SalesTermsandConditions.

Freescale and the Freescale logo are trademarks of Freescale Semiconductor, Inc., Reg. U.S. Pat. & Tm. Off. All other product or service names are the property of their respective owners.

© 2014 Freescale Semiconductor, Inc.