



STEP-UP, SUPER-SMALL PACKAGE, 1.2 MHz PWM / PFM SWITCHABLE SWITCHING REGULATOR

www.sii-ic.com

© SII Semiconductor Corporation, 2010

Rev.2.0_01

The S-8363 Series is a CMOS step-up switching regulator which consists of a reference voltage source, an oscillation circuit, an error amplifier, a phase compensation circuit, a current limit circuit, and a start-up circuit.

Due to the operation of the PWM / PFM switching control, pulses are skipped under the light load operation and the S-8363 Series prevents decrease in efficiency caused by IC's operating current.

The S-8363 Series is capable of start-up from 0.9 V ($I_{OUT} = 1$ mA) by the start-up circuit, and is suitable for applications which use one dry cell.

The output voltage is freely settable from 1.8 V to 5.0 V by external parts.

Ceramic capacitors can be used for output capacitor. Small packages SNT-6A and SOT-23-6 enable high-density mounting.

■ Features

- Low operation voltage : Start-up from 0.9 V ($I_{OUT} = 1$ mA) guaranteed
- Oscillation frequency : 1.2 MHz
- Input voltage range : 0.9 V to 4.5 V
- Output current : 300 mA ($V_{IN} = 1.8$ V, $V_{OUT} = 3.3$ V)
- Reference voltage : 0.6 V \pm 2.5%
- Efficiency : 85%
- Soft start function : 1.2 ms typ.
- Low current consumption : During switching-off, 95 μ A typ.
- Duty ratio : PWM / PFM switching control
max.88%
- Power-off function : Current consumption during power-off 3.0 μ A max.
- Current limit circuit : limits the peak value of inductor current
- Nch power MOS FET ON resistance : 0.25 Ω typ.
- Start-up function : Operation with fixed duty pulse under the V_{OUT} voltage of 1.4 V or less
- Lead-free, Sn 100%, halogen-free*1

*1. Refer to "■ Product Name Structure" for details.

■ Applications

- MP3 players, digital audio players
- Digital cameras, GPS, wireless transceiver
- Portable devices

■ Packages

- SNT-6A
- SOT-23-6

■ Block Diagram

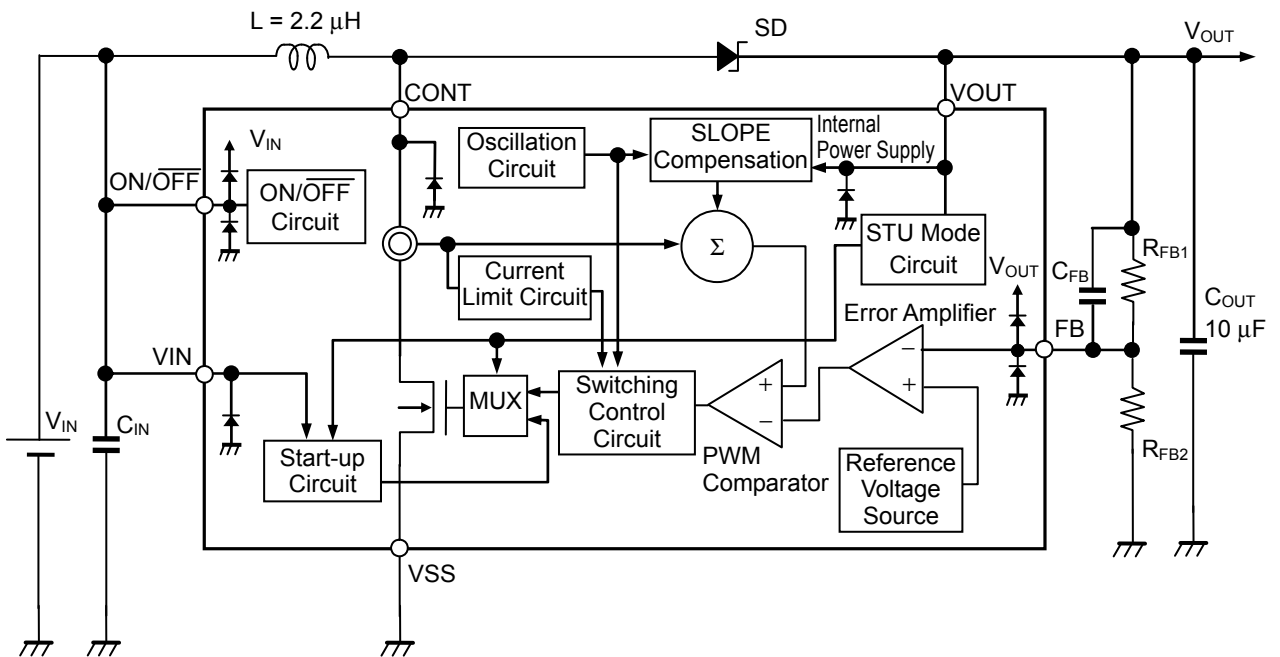
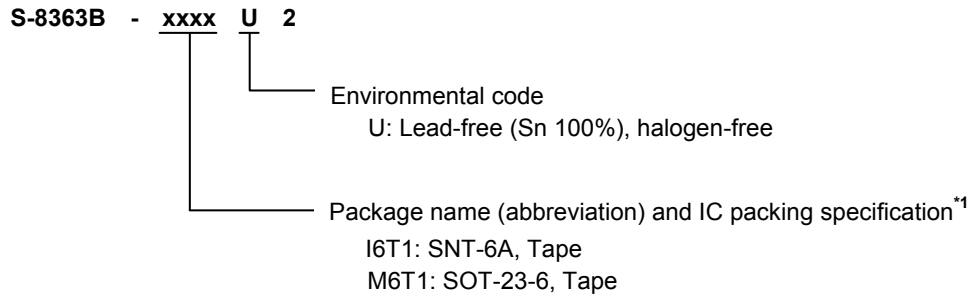

Figure 1

■ Product Name Structure

Users can select the packages for the S-8363 Series. Refer to “1. Product name” regarding the contents of product name, “2. Package” regarding the package drawings and “3. Product list” regarding the product type.

1. Product name



*1. Refer to the tape specification.

2. Package

Package name	Drawing code			
	Package	Tape	Reel	Land
SNT-6A	PG006-A-P-SD	PG006-A-C-SD	PG006-A-R-SD	PG006-A-L-SD
SOT-23-6	MP006-A-P-SD	MP006-A-C-SD	MP006-A-R-SD	—

3. Product list

Table 1

SNT-6A	SOT-23-6
S-8363B-I6T1U2	S-8363B-M6T1U2

Remark Please select products of environmental code = U for Sn 100%, halogen-free products.

■ Pin Configurations

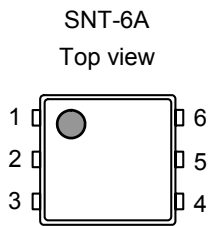

Figure 2

Table 2 SNT-6A

Pin No.	Symbol	Description
1	FB	Output voltage feedback pin
2	VSS	GND pin
3	CONT	External inductor connection pin
4	VIN	IC power supply pin
5	VOUT	Output voltage pin
6	ON/ $\overline{\text{OFF}}$	Power-off pin "H" : Power-on (normal operation) "L" : Power-off (standby)

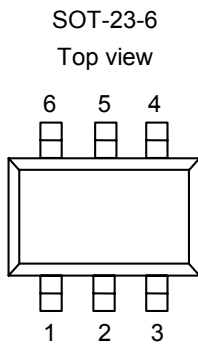

Figure 3

Table 3 SOT-23-6

Pin No.	Symbol	Description
1	ON/ $\overline{\text{OFF}}$	Power-off pin "H" : Power-on (normal operation) "L" : Power-off (standby)
2	VOUT	Output voltage pin
3	VIN	IC power supply pin
4	CONT	External inductor connection pin
5	VSS	GND pin
6	FB	Output voltage feedback pin

■ Absolute Maximum Ratings

Table 4 Absolute Maximum Ratings

(Ta = +25°C, Vss = 0 V unless otherwise specified)

Item	Symbol	Absolute Maximum Ratings	Unit
VIN pin voltage	V _{IN}	V _{SS} -0.3 to V _{SS} +5.0	V
VOU _T pin voltage	V _{OUT}	V _{SS} -0.3 to V _{SS} +6.0	V
FB pin voltage	V _{FB}	V _{SS} -0.3 to V _{OUT} +0.3	V
CONT pin voltage	V _{CONT}	V _{SS} -0.3 to V _{SS} +6.0	V
ON/OFF pin voltage	V _{ON/OFF}	V _{SS} -0.3 to V _{IN} +0.3	V
Power Dissipation	SNT-6A	400*1	mW
	SOT-23-6	650*1	mW
Operating ambient temperature	T _{opr}	-40 to +85	°C
Storage temperature	T _{stg}	-40 to +125	°C

*1. When mounted on board

[Mounted board]

- (1) Board size : 114.3 mm × 76.2 mm × t1.6 mm
- (2) Name : JEDEC STANDARD51-7

Caution The absolute maximum ratings are rated values exceeding which the product could suffer physical damage. These values must therefore not be exceeded under any conditions.

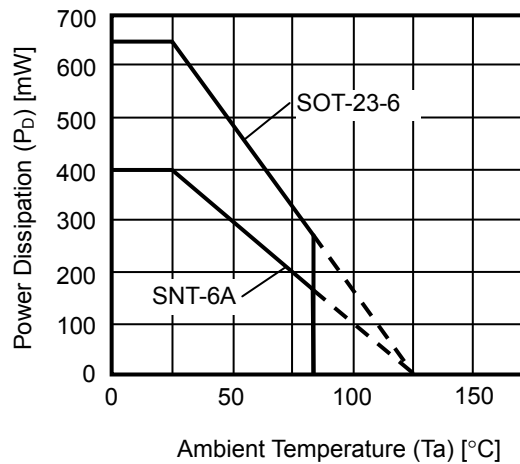

Figure 4 Package Power Dissipation (When Mounted on Board)

■ Electrical Characteristics

Table 5 Electrical Characteristics

($V_{IN} = 1.8\text{ V}$, $V_{OUT} = 3.3\text{ V}$, $T_a = +25^\circ\text{C}$ unless otherwise specified)

Item	Symbol	Conditions	Min.	Typ.	Max.	Unit	Test Circuit
Operating start voltage*1	V_{ST}	$I_{OUT} = 1\text{ mA}$, $V_{OUT(S)}^{*2} = 3.3\text{ V}$	—	—	0.9	V	2
Operating input voltage	V_{IN}	—	—	—	4.5	V	2
Output voltage range	$V_{OUT(R)}$	—	1.8	—	5.0	V	2
FB voltage	V_{FB}	—	0.585	0.600	0.615	V	1
FB voltage temperature coefficient	$\frac{\Delta V_{FB}}{\Delta T_a}$	$T_a = -40^\circ\text{C}$ to $+85^\circ\text{C}$	—	± 100	—	ppm/ $^\circ\text{C}$	1
FB pin input current	I_{FB}	$V_{OUT} = 1.8\text{ V}$ to 5.5 V , FB pin	-0.1	—	+0.1	μA	1
Current consumption during operation	I_{IN1}	During switching, at no load $V_{FB} = V_{FB(S)}^{*3} \times 0.95$	—	6	15	μA	1
	I_{SS1}		—	450	650	μA	1
Current consumption during switching off	I_{IN2}	During switching stop $V_{FB} = V_{FB(S)} \times 1.1$	—	6	15	μA	1
	I_{SS2}		—	95	150	μA	1
Current consumption during power-off	I_{SSS}	$V_{ON/OFF} = 0\text{ V}$, $V_{IN} = V_{OUT} = 4.5\text{ V}$	—	—	3.0	μA	1
Oscillation frequency	f_{OSC}	—	1.0	1.2	1.4	MHz	2
Maximum duty ratio	MaxDuty	$V_{FB} = V_{FB(S)} \times 0.95$	82	88	94	%	2
PWM / PFM switching duty ratio	PFMDuty	—	—	13	—	%	2
Power MOS FET ON resistance*4	R_{NFET}	—	—	0.25	—	Ω	1
Power MOS FET leakage current	I_{LSW}	$V_{ON/OFF} = 0\text{ V}$	—	0.01	0.5	μA	1
Limited current	I_{LIM}	—	0.9	1.1	1.3	A	3
High level input voltage	V_{SH}	$V_{IN} = 1.8\text{ V}$ to 4.5 V , ON/OFF pin	0.75	—	—	V	1
Low level input voltage	V_{SL}	$V_{IN} = 1.8\text{ V}$ to 4.5 V , ON/OFF pin	—	—	0.25	V	1
High level input current	I_{SH}	$V_{IN} = 1.8\text{ V}$ to 4.5 V , ON/OFF pin	-0.1	—	0.1	μA	1
Low level input current	I_{SL}	$V_{IN} = 1.8\text{ V}$ to 4.5 V , ON/OFF pin	-0.1	—	0.1	μA	1
Soft-start time*5	t_{SS}	—	0.6	1.2	1.8	ms	2

- *1. This is the guaranteed value measured with external parts shown in “Table 6 External Parts List” and with test circuits shown in Figure 6. The operating start voltage varies largely depending on diode’s forward voltage. Perform sufficient evaluation with actual application.
- *2. $V_{OUT(S)}$ can be set by the ratio of V_{FB} value and the output voltage setting resistors (R_{FB1} , R_{FB2}). For details, refer to “■ External Parts Selection”.
- *3. $V_{FB(S)}$ is a setting value for FB voltage.
- *4. Power MOS FET ON resistance largely varies depending on the V_{OUT} voltage.
- *5. This is when the V_{OUT} voltage startups from the STU release voltage or more. The soft-start time largely varies depending on the load current and the input voltage when the S-8363 Series startups from the STU release voltage or less, because the S-8363 Series once enters the start-up mode. Refer to “■ 2. Low voltage start-up” for STU release voltage.

■ External Parts List When Measuring Electrical Characteristics

Table 6 External Parts List

Element name	Symbol	Constants	Manufacturer	Part number
Inductor	L	2.2 μH	TDK Corporation	VLF302510
Diode	SD	—	TOSHIBA CORPORATION	CRS08
Input capacitor	C_{IN}	1 μF	TAIYO YUDEN Co., Ltd.	EMK107B7105KA
Output capacitor	C_{OUT}	10 μF	TAIYO YUDEN Co., Ltd.	LMK212BJ106KD
FB pin capacitor	C_{FB}	47 pF	TAIYO YUDEN Co., Ltd.	UMK105CH470JV
Output voltage setting resistor 1	R_{FB1}	68 k Ω	ROHM Co., Ltd.	MCR03 series
Output voltage setting resistor 2	R_{FB2}	15 k Ω	ROHM Co., Ltd.	MCR03 series

■ Test Circuits

1.

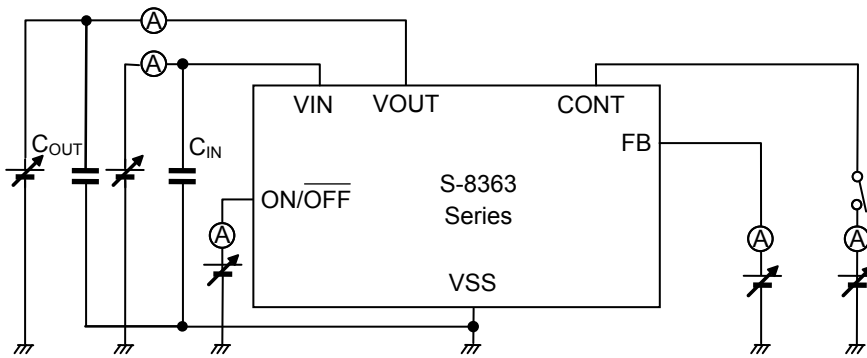

Figure 5

2.

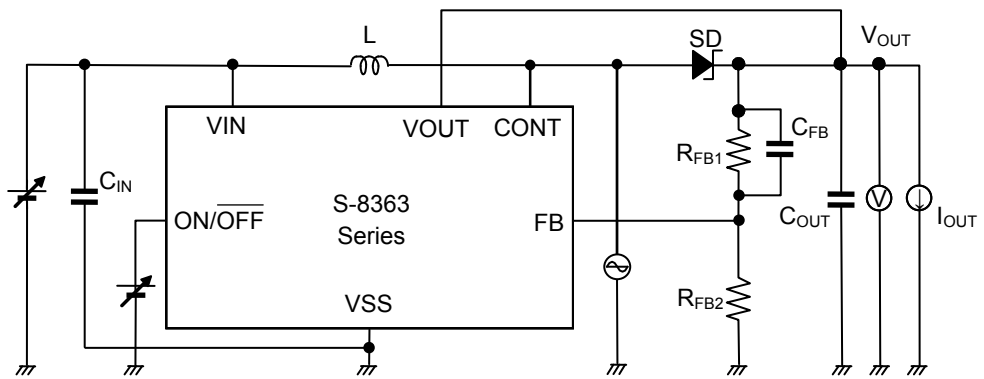

Figure 6

3.

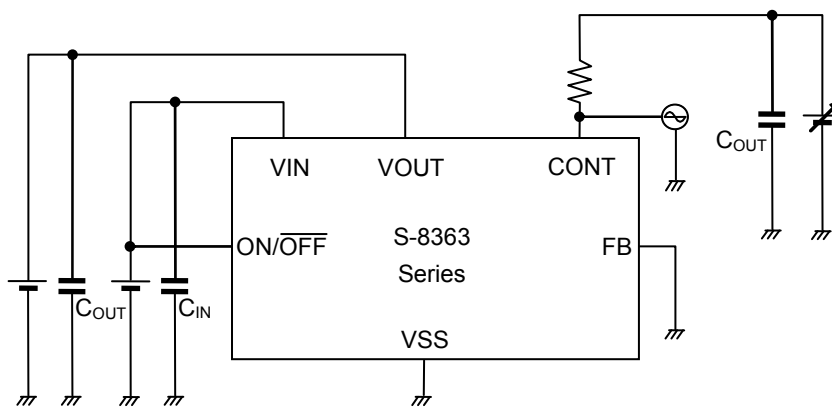

Figure 7

■ Operation

1. Switching control method

The S-8363 Series switching regulator automatically switches between the pulse width modulation method (PWM) and pulse frequency modulation method (PFM) according to the load current.

A low ripple power can be supplied by operating on PWM control for which the pulse width changes up to 88% in the range where the output load current is large.

The S-8363 Series operates on PFM control when the output load current is small and the pulses are skipped according to the amount of the load current. Therefore, the oscillation circuit intermittently oscillates, reducing the self-current consumption. This prevents decrease in efficiency when the output load current is small. The ripple voltage during the PFM control is very small, so that the S-8363 Series realizes high efficiency and the low-noise power supply.

The point at which PWM control switches to PFM control varies depending on the external element (inductor, diode, etc.), input voltage value, and output voltage value, and this method achieves high efficiency in the output load current of about 100 μ A.

2. Low voltage start-up

2.1 Start-up circuit

The S-8363 Series can startup from 0.9 V. When the V_{OUT} voltage at $ON/\overline{OFF} = "H"$ does not reach the STU release voltage, the start-up circuit starts the operation and outputs the fixed duty pulse to the CONT pin. By this, the V_{OUT} voltage starts step-up. After that, the V_{OUT} voltage reaches the STU release voltage and the STU mode circuit is set in STU release condition, therefore, the switching control circuit starts stable operation due to the soft-start function. Simultaneously, the start-up circuit is set in disable condition, so that the S-8363 Series prevents excessive current consumption.

2.2 Start-up mode (STU mode) circuit

The STU mode circuit monitors the V_{OUT} voltage, and switches the operation modes between start-up period and normal control period of the switching control circuit. The STU release voltage is internally fixed at 1.4 V (typ.), and has hysteresis of approx. 0.15 V. When the V_{OUT} voltage decreases to 1.25 V (typ.) from release condition, the STU mode circuit is set in the STU detection condition, shifting to the start-up period. Several μs to several ten μs is taken to shift from STU release to PWM release. During this the step-up operation is not performed, therefore, the V_{OUT} voltage may largely decrease depending on the size of load.

During applying $ON/\overline{OFF} = "L"$, the STU mode circuit is set in disable condition, so that the S-8363 Series prevents excessive current consumption.

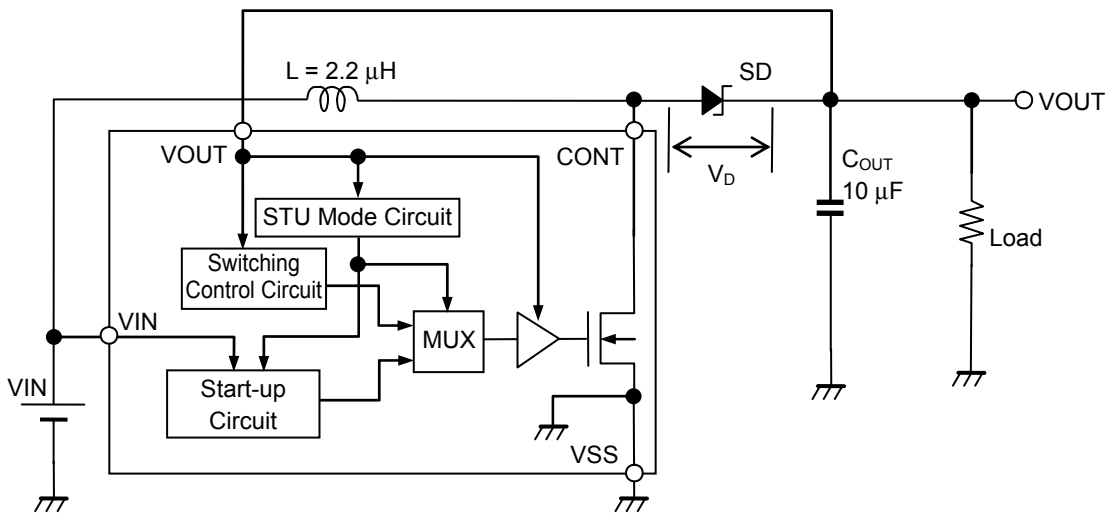

Figure 8 Start-up Circuit

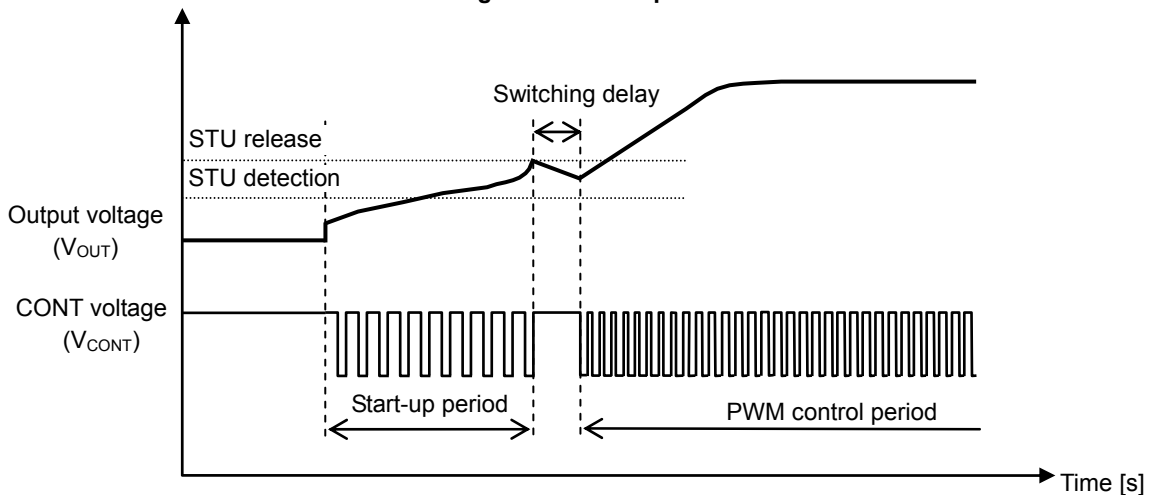

Figure 9 Start-up Sequence

2.3 Schottky barrier diode

A schottky barrier diode (SD) is necessary to operate the S-8363 Series. The VOUT pin also works as the power supply pin. The voltage applied on the VOUT pin when ON/OFF = "L" is $V_{IN} - V_D$. V_D is forward voltage for step-down of SD, and largely varies depending on the forward current I_f of SD and ambient temperature, but V_d is approx. 0.2 V to 0.5 V.

When the S-8363 Series startups from 0.9 V, use a SD with specially low V_D . When using CRS08 for the S-8363 Series, start-up is guaranteed when $T_a = +25^\circ\text{C}$ and a load current of 1 mA.

Satisfy the following conditions when using other SDs.

- Low forward voltage (V_D)
- High switching speed
- Reverse withstand voltage of $V_{OUT} +$ spike voltage or more
- Rated current of I_{PK} or more

Table 7 Typical Schottky Diodes

Manufacturer	Name
TOSHIBA CORPORATION	CRS02
	CRS08
ROHM Co., Ltd.	RB161M-20TR
	RB051LA-40TR
	RB070M-30TR
	RB161SS-20T2R

Remark Generally, in diodes with low forward volage V_D , reverse leakage current I_r tends to increases. Especially, increase of I_r in high temperature is significant. To prevent decrease in efficiency, choose a diode with low I_r when low voltage start-up is unnecessary.

3. Soft-start function

The S-8363 Series has the built-in soft-start circuit. When power-on (connecting ON/OFF to V_{IN}) or after start-up at ON/OFF = "H", the output voltage (V_{OUT}) gradually rises, suppressing rush current and overshoot of the output voltage. In the S-8363 Series, the soft-start time (t_{ss}) is from start-up to the time to reach 90% of the V_{OUT} output voltage setting value ($V_{OUT(S)}$). A reference voltage adjustment method is adopted as the soft-start method, the reference voltage gradually rises from 0 V simultaneously with start of the soft-start. The soft-start circuit has two operation modes which is selected according to the V_{OUT} voltage at start-up.

3.1 V_{OUT} voltage at start-up > STU release voltage

The soft-start starts when the reference voltage gradually rises after ON/OFF = "H".

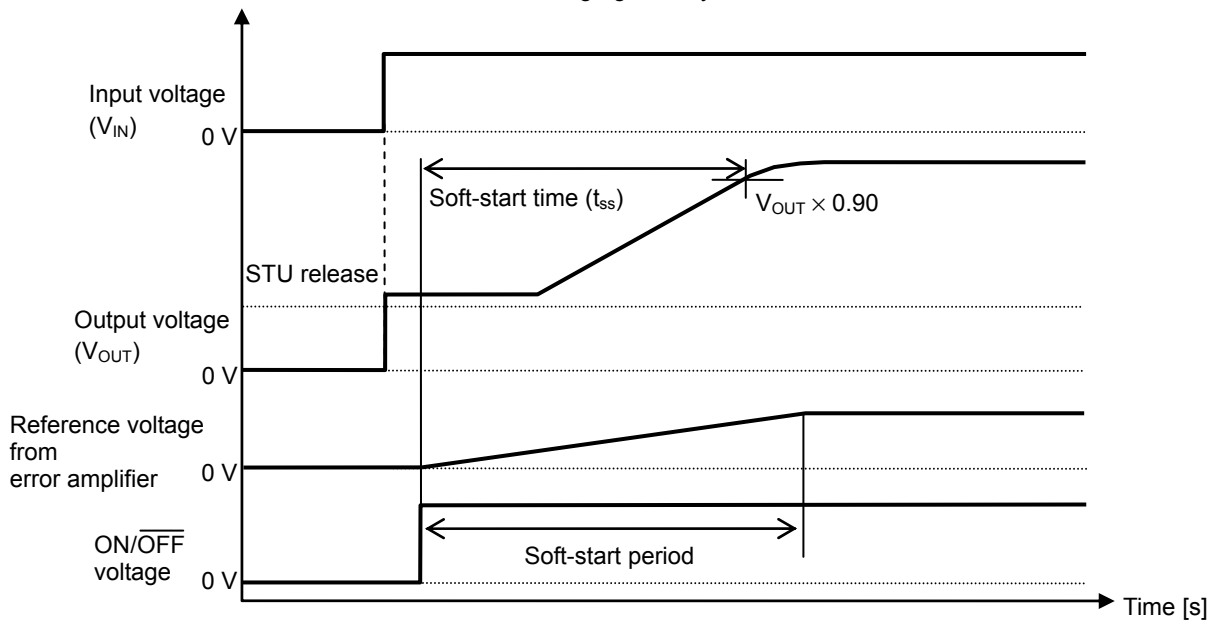

Figure 10

3.2 V_{OUT} voltage at start-up < STU release voltage

After $\overline{ON/OFF}$ = "H", step-up starts by the start-up operation. When the V_{OUT} voltage reaches the STU release voltage, the soft-start starts.

Since the length of the start-up period largely varies depending on the input voltage, load current, external parts and ambient temperature, the soft-start time varies according to them. Perform sufficient evaluation with actual application.

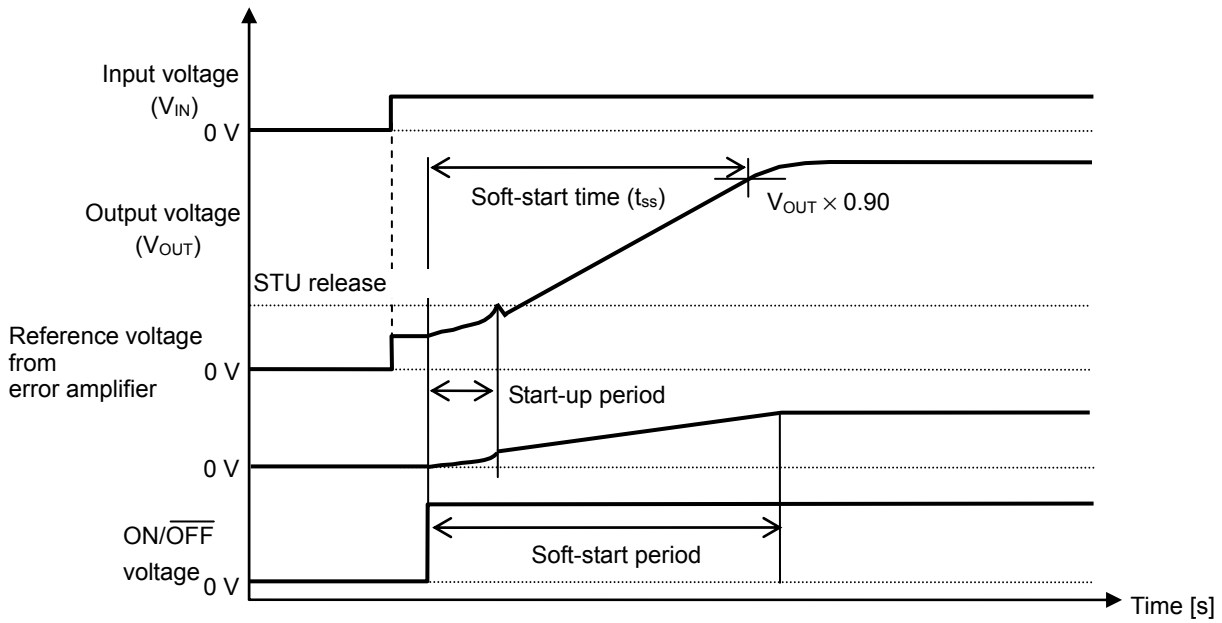

Figure 11

3.3 Condition of performing soft-start again

The condition to reset after the reference voltage once rises (reference voltage from error amplifier = 0 V) is to set the ON/OFF pin voltage to "L". Setting ON/OFF = "H" starts soft-start again. When the V_{OUT} voltage drops and decreases more than the STU detection voltage by an overload, the soft-start circuit shifts to the start-up period. When the V_{OUT} voltage is restored by releasing overload, the soft-start function is performed. If the V_{OUT} voltage is not decreased less than the STU detection voltage, the soft-start function is not performed when restoration.

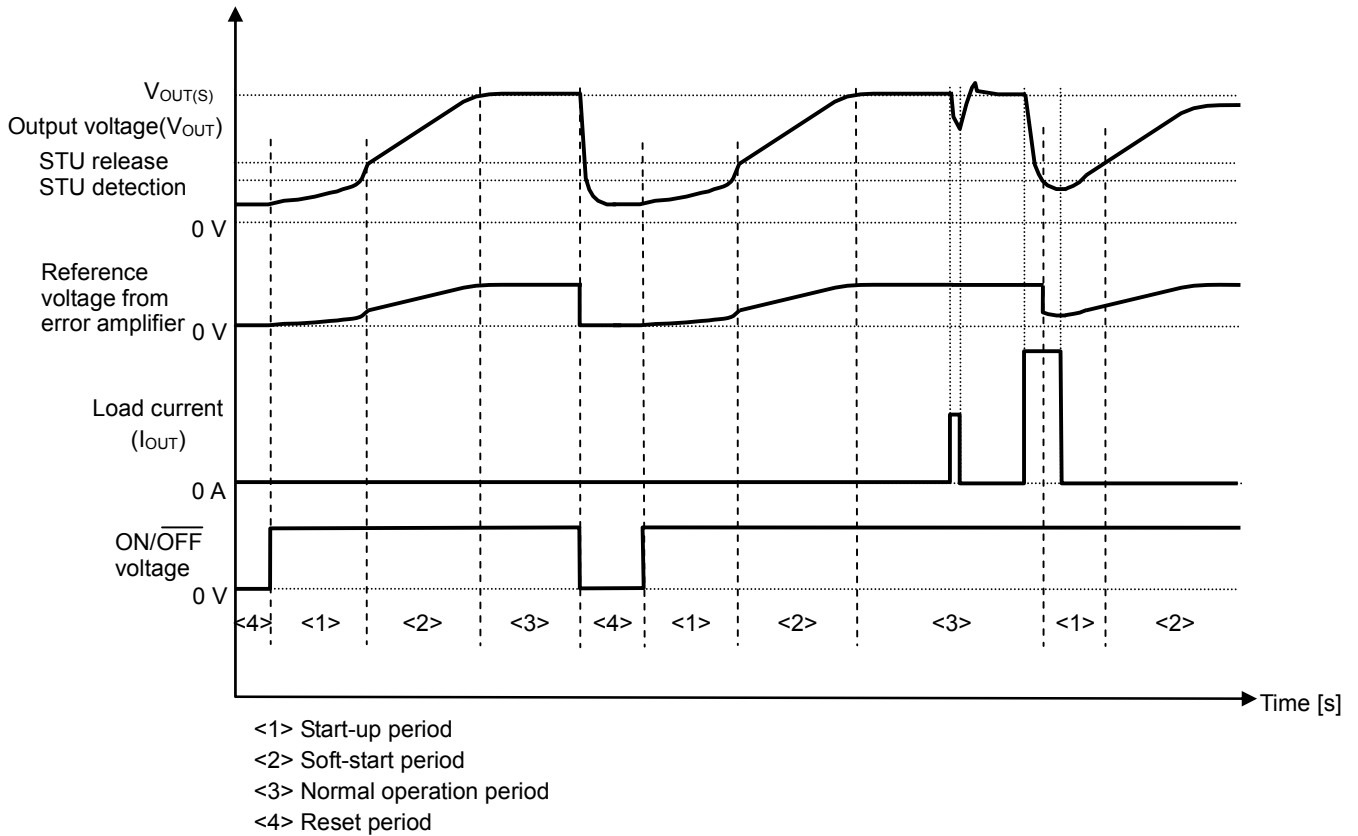

Figure 12 Reset Condition for Soft-Start

4. Power-off pin

This pin stops or starts step-up operations.

When the ON/ $\overline{\text{OFF}}$ pin is set to the low level, the internal driver of the CONT pin is turned off and all internal circuits stop substantially reducing the current consumption.

The ON/ $\overline{\text{OFF}}$ pin is set up as shown in **Figure 13** and is internally pulled down by using the depression transistor, so all circuits stop even if this pin is floating. Do not apply a voltage of between 0.25 V and 0.75 V to the ON/ $\overline{\text{OFF}}$ pin because applying such a voltage increases the current consumption. If the ON/ $\overline{\text{OFF}}$ pin is not used, connect it to the VIN pin.

Table 8

ON/ $\overline{\text{OFF}}$ pin	CR oscillation circuit	Output voltage
"H"	Operates	Set value
"L"	Stops	$V_{\text{IN}} - V_{\text{D}}$

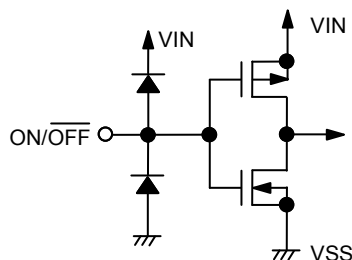

Figure 13

5. Current limit circuit

A current limit circuit is built in the S-8363 Series.

The current limit circuit monitors the current that flows in the Nch power MOS FET and limits current in order to prevent thermal destruction of the IC due to an overload or magnetic saturation of the inductor.

When a current exceeding the current limit detection value flows in the Nch power MOS FET, the current limit circuit operates and turns off the Nch power MOS FET since the current limit detection until one clock of the oscillator ends. The Nch power MOS FET is turned on in the next clock and the current limit circuit resumes current detection operation. If the value of the current that flows in the Nch power MOS FET remains the current limit detection value or more, the current limit circuit functions again and the same operation is repeated. Once the value of the current that flows in the Nch power MOS FET is lowered up to the specified value, the normal operation status restores.

The current limit detection value is fixed to 1.1 A (typ.) in the IC. However, under the condition that ON duty is small, between the detection delay time of the current limit circuit and the ON time of the Nch power MOS FET, the difference is small. Therefore, the current value which is actually limited is increased. Usually, when the difference between the VIN pin and VOUT pin is small, on duty is decreased and the limited current value is increased.

■ Operation Principles

The S-8363 Series is a step-up switching regulator. **Figure 14** shows the basic circuit diagram.

Step-up switching regulators start current supply by the input voltage (V_{IN}) when the Nch power MOS FET is turned on and holds energy in the inductor at the same time. When the Nch power MOS FET is turned off, the CONT pin voltage is stepped up to discharge the energy held in the inductor and the current is discharged to V_{OUT} through the diode. When the discharged current is stored in C_{OUT} , a voltage is generated, and the potential of V_{OUT} increases until the voltage of the FB pin reaches the same potential as the internal reference voltage.

For the PWM control method, the switching frequency (f_{osc}) is fixed and the V_{OUT} voltage is held constant according to the ratio of the ON time and OFF time (ON duty) of the Nch power MOS FET in each period.

In the PWM control method, the V_{OUT} voltage is held constant by controlling the ON time.

In the PFM control method, the Nch power MOS FET is turned on by fixed duty. When energy is discharged to V_{OUT} once and the V_{OUT} potential exceeds the set value, the Nch power MOS FET stays in the off status until V_{OUT} decreases to the set value or less due to the load discharge. Time V_{OUT} decreases to the set value or less depends on the amount of load current, so, the switching frequency varies depending on this current.

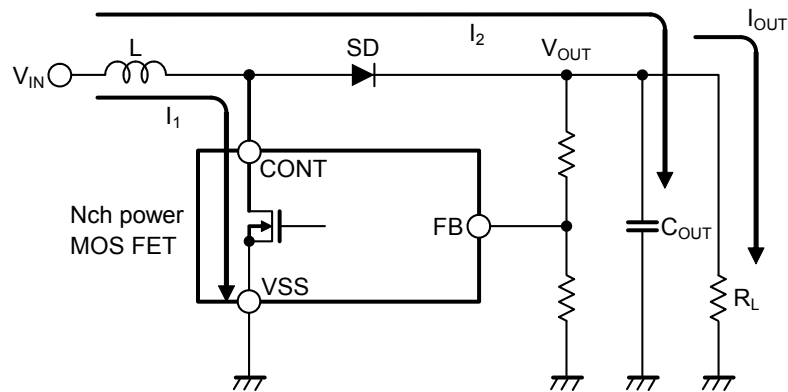

Figure 14 Basic Circuit of Step-up Switching Regulator

The ON duty in the current continuous mode can be calculated by using the equation below. Use the S-8363 Series in the range where the ON duty is less than the maximum duty.

The maximum duty is 88% (typ.).

$$\text{ON duty} = \left(1 - \frac{V_{IN}}{V_{OUT} + V_D * 1} \right) \times 100 \text{ [\%]}$$

*1. V_D : Forward voltage of diode

1. Continuous current mode

The following explains the current that flows into the inductor when the step-up operation stabilizes in a certain status and I_{OUT} is sufficiently large.

When the Nch power MOS FET is turned on, current (I_1) flows in the direction shown in **Figure 14**. The inductor current (I_L) at this time gradually increases in proportion with the ON time (t_{ON}) of the Nch power MOS FET, as shown in **Figure 15**.

Current change of inductor within t_{ON} :

$$\begin{aligned} \Delta I_{L(ON)} &= I_L \text{ max.} - I_L \text{ min.} \\ &= \frac{V_{IN}}{L} \times t_{ON} \end{aligned}$$

When the Nch power MOS FET is turned off, the voltage of the CONT pin is stepped up to $V_{OUT} + V_D$ and the voltage on both ends of the inductor becomes $V_{OUT} + V_D - V_{IN}$. However, it is assumed here that $V_{OUT} \gg V_D$ and V_D is ignored.

Current change of inductor within t_{OFF} :

$$\Delta I_{L(OFF)} = \frac{V_{OUT} - V_{IN}}{L} \times t_{OFF}$$

The input power equals the output power in an ideal situation where there is no loss by components.

$I_{IN(AV)}$:

$$\begin{aligned} P_{IN} &= P_{OUT} \\ I_{IN(AV)} \times V_{IN} &= I_{OUT} \times V_{OUT} \\ \therefore I_{IN(AV)} &= \frac{V_{OUT}}{V_{IN}} \times I_{OUT} \dots\dots\dots (1) \end{aligned}$$

The current that flows in the inductor consists of a ripple current that changes due to variation over time and a direct current.

From **Figure 15** :

$I_{IN(AV)}$:

$$\begin{aligned} I_{IN(AV)} &= I_{IN(DC)} + \frac{\Delta I_L}{2} \\ &= I_{IN(DC)} + \frac{V_{OUT} - V_{IN}}{2 \times L} \times t_{OFF} \\ &= I_{IN(DC)} + \frac{V_{IN}}{2 \times L} \times t_{ON} \dots\dots\dots (2) \end{aligned}$$

Above, the continuous mode is the operation mode when $I_{IN(DC)} > 0$ as shown in **Figure 15** and the inductor current continuously flows.

While the output current (I_{OUT}) continues to decrease, $I_{IN(DC)}$ reaches 0 as shown in **Figure 16**. This point is the critical point of the continuous mode.

As shown in equations (1) and (2), the direct current component ($I_{IN(DC)}$) depends on I_{OUT} .

$I_{OUT(0)}$ when $I_{IN(DC)}$ reaches 0 (critical point) :

$$I_{OUT(0)} = \frac{t_{ON} \times V_{IN}^2}{2 \times L \times V_{OUT}}$$

When the output current decreases below $I_{OUT(0)}$, the current flowing in the inductor stops flowing in the t_{OFF} period as shown in **Figure 17**. This is the discontinuous mode.

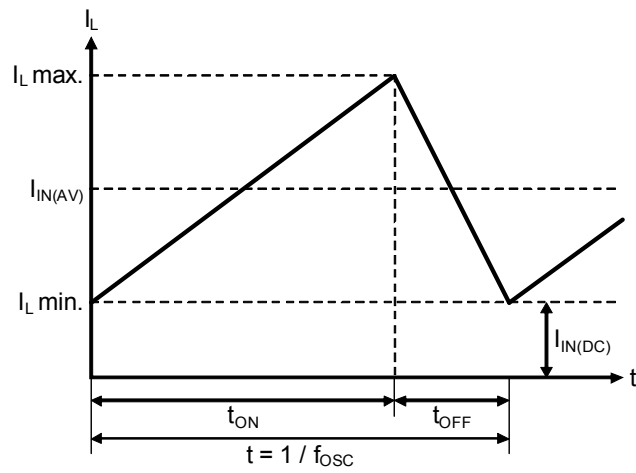

Figure 15 Continuous Mode (Current Cycle of Inductor Current I_L)

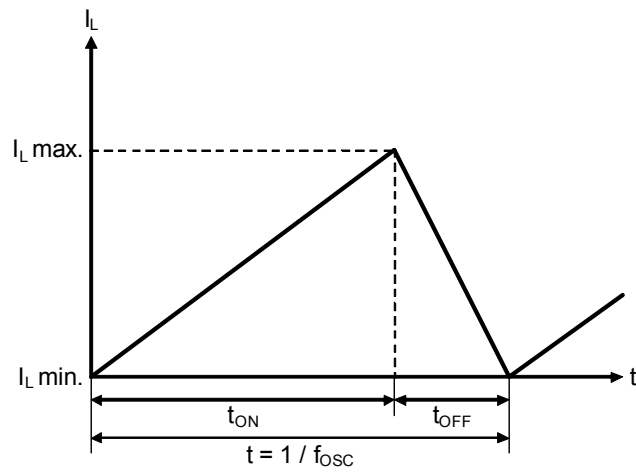

Figure 16 Critical Point (Current Cycle of Inductor Current I_L)

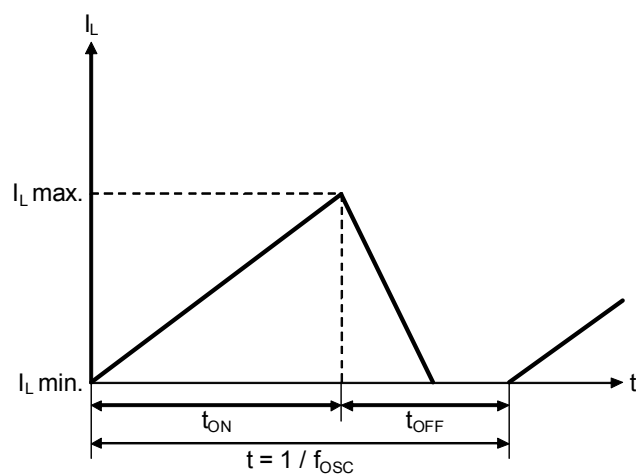

Figure 17 Discontinuous Mode (Current Cycle of Inductor Current I_L)

External Parts Selection

1. Inductor

The recommended L value of the S-8363 Series is 2.2 μH.

Caution When selecting an inductor, be careful about its allowable current. If a current exceeding the allowable current flows through the inductor, magnetic saturation occurs, substantially lowering the efficiency and destroying ICs due to large current. Therefore, select an inductor such that I_{PK} does not exceed the allowable current. The following equations express I_{PK} in the ideal statuses in the discontinuous and continuous modes :

$$I_{PK} = \sqrt{\frac{2 \times I_{OUT} \times (V_{OUT} + V_D^{*2} - V_{IN})}{f_{OSC}^{*1} \times L}} \quad (\text{Discontinuous mode})$$

$$I_{PK} = \frac{V_{OUT} + V_D^{*2}}{V_{IN}} \times I_{OUT} + \frac{(V_{OUT} + V_D^{*2} - V_{IN}) \times V_{IN}}{2 \times (V_{OUT} + V_D^{*2}) \times f_{OSC}^{*1} \times L} \quad (\text{Continuous mode})$$

*1. f_{OSC} : oscillation frequency

*2. V_D is the forward voltage of a diode. The reference value is 0.4 V.

However, current exceeding the above equation flows because conditions are practically not ideal. Perform sufficient evaluation with actual application.

Table 9 Typical Inductors

Manufacturer	Name	L value	Direct resistor	Rated current	Size (L × W × H) [mm]
TDK Corporation	VLF302510-2R2M	2.2 μH	0.084 Ω max.	1.23 A max.	3.0 × 2.5 × 1.0
	VLS3010T-2R2M	2.2 μH	0.116 Ω max.	1.2 A max.	3.0 × 3.0 × 1.0
	VLS201610E	2.2 μH	0.276 Ω max.	0.94 A max.	2.0 × 1.6 × 0.95
	MLP2012S2R2M	2.2 μH	0.300 Ω max.	0.8 A max.	2.0 × 1.25 × 1.0
Coilcraft, Inc	LPS3010-222ML	2.2 μH	0.220 Ω max.	1.3 A max.	3.0 × 3.0 × 1.0
Murata Manufacturing Co., Ltd.	LQM2HPN2R2MG0	2.2 μH	0.080 Ω ± 25%	1.3 A max.	2.5 × 2.0 × 1.0
	LQH3NPN2R2NG0	2.2 μH	0.140 Ω ± 20%	1.25 A max.	2.7 × 3.0 × 1.0
TAIYO YUDEN Co., Ltd.	NR3010T2R2M	2.2 μH	0.114 Ω max.	1.1 A max.	3.0 × 3.0 × 1.0
	NR4010T2R2N	2.2 μH	0.180 Ω max.	1.15 A max.	4.0 × 4.0 × 1.0
	BRL2518T2R2M	2.2 μH	0.1755 Ω max.	0.85 A max.	2.5 × 1.8 × 1.2

2. Diode

Use an externally mounted that meets the following conditions.

- Low forward voltage (Schottky barrier diode or similar types)
- High switching speed
- Reverse withstand voltage of V_{OUT} + spike voltage or more
- Rated current of I_{PK} or more

3. Input capacitor (C_{IN}) and output capacitor (C_{OUT})

To improve efficiency, an input capacitor (C_{IN}) lowers the power supply impedance and averages the input current. Select C_{IN} according to the impedance of the power supply used. The recommended capacitance is 1 μ F or more for the S-8363 Series.

An output capacitor (C_{OUT}), which is used to smooth the output voltage, requires a capacitance larger than that of the step-down type because the current is intermittently supplied from the input to the output side in the step-up type. When the output voltage is low or the load current is large, enlarging an output capacitance value is required. Moreover, when the output voltage is high, connecting a 0.1 μ F ceramic capacitor in parallel is required. Mount near a V_{OUT} pin as possible.

The indication of an output capacitor to the setting value of V_{OUT} voltage is shown in the **table 10**. Perform thorough evaluation using an actual application to set the constant when selecting parts.

A ceramic capacitor can be used for both the input and output.

Table 10 Recommended Output Capacitance

V_{OUT} voltage	Output capacitor (C_{OUT})
< 2.5 V	10 μ F \times 2
2.5 V to 4.0 V	10 μ F
4.0 V <	10 μ F + 0.1 μ F

4. Output voltage setting resistors (R_{FB1}, R_{FB2}), capacitor for phase compensation (C_{FB})

For the S-8363 Series, V_{OUT} can be set to any value by using external divider resistors. Connect the divider resistors between the V_{OUT} and V_{SS} pins.

Because V_{FB} = 0.6 V typ., V_{OUT} can be calculated by using the following equation :

$$V_{OUT} = \frac{R_{FB1} + R_{FB2}}{R_{FB2}} \times 0.6$$

Connect divider resistors R_{FB1} and R_{FB2} as close to the IC as possible to minimize the effects of noise. If noise has an effect, adjust the values of R_{FB1} and R_{FB2} so that R_{FB1} + R_{FB2} < 100 kΩ.

C_{FB}, which is connected in parallel with R_{FB1}, is a capacitor for phase compensation.

By setting the zero point (the phase feedback) by adding capacitor C_{FB} to output voltage setting resistor R_{FB1} in parallel, the phase margin increases, improving the stability of the feedback loop. To effectively use the feedback portion of the phase based on the zero point, define C_{FB} by using the following equation :

$$C_{FB} \cong \frac{\sqrt{L \times C_{OUT}}}{3 \times R_{FB1}} \times \frac{V_{OUT}}{V_{DD}}$$

This equation is only a guide.

The following explains the optimum setting.

To efficiently use the feedback portion of the phase based on the zero point, specify settings so that the phase feeds back at the zero point frequency (f_{zero}) of R_{FB1} and C_{FB} according to the phase delay at the pole frequency (f_{pole}) of L and C_{OUT}. The zero point frequency is generally set slightly higher than the pole frequency.

The following equations are used to determine the pole frequency of L and C_{OUT} and the zero point frequency set using R_{FB1} and C_{FB}.

$$f_{pole} \cong \frac{1}{2 \times \pi \times \sqrt{L \times C_{OUT}}} \times \frac{V_{DD}}{V_{OUT}}$$

$$f_{zero} \cong \frac{1}{2 \times \pi \times R_{FB1} \times C_{FB}}$$

The transient response can be improved by setting the zero point frequency in a lower frequency range. If, however, the zero point frequency is set in a significantly lower range, the gain increases in the range of high frequency and the phase margin decreases. This might result in unstable operation. Determine the proper value after sufficient evaluation with actual application.

The typical constants based on our evaluation are shown in **Table 11**.

Table 11 Example of Constant for External Parts

V _{OUT(S)} [V]	V _{IN} [V]	R _{FB1} [kΩ]	R _{FB2} [kΩ]	C _{FB} [pF]
1.8	1.2	30	15	82
2.48	1.2	47	15	68
3.32	1.8	68	15	47
4.2	1.8	90	15	39
5.0	1.8	110	15	39

■ Standard Circuit

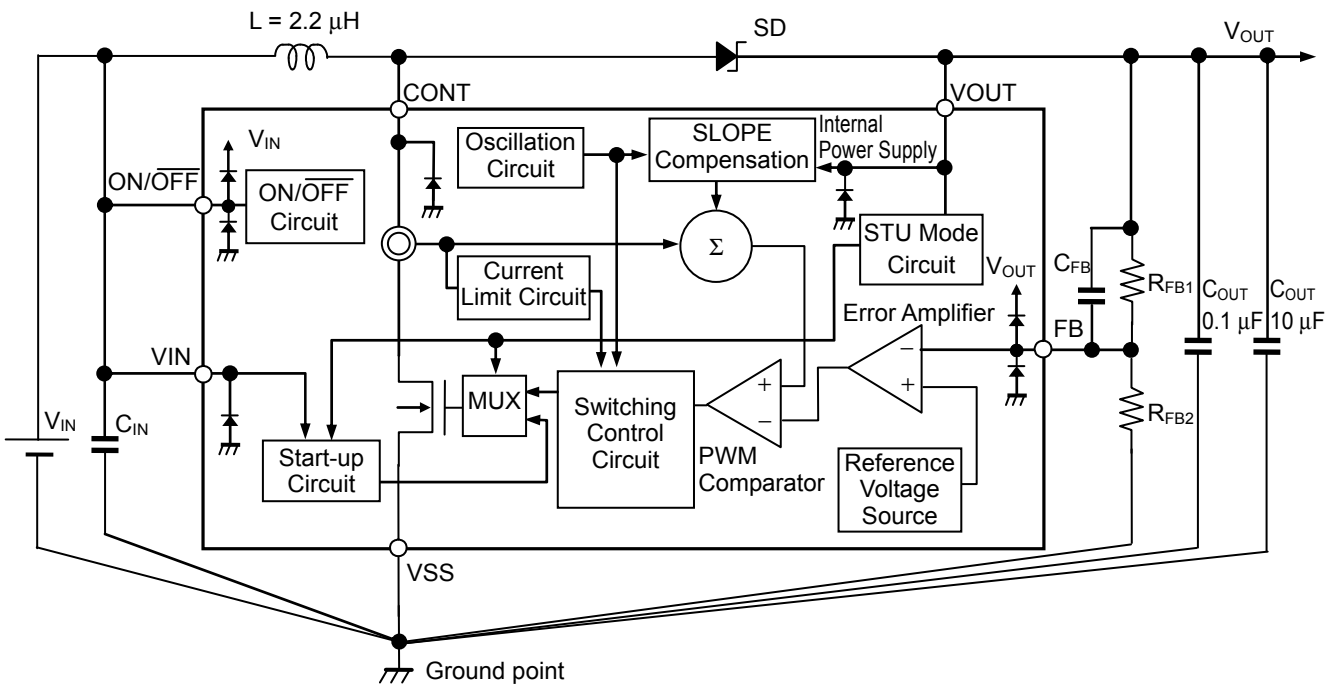

Figure 18

Caution The above connection diagram and constant will not guarantee successful operation. Perform thorough evaluation using an actual application to set the constants.

■ Precaution

- Mount external capacitors and inductor as close as possible to the IC. Set single point ground.
- Characteristics ripple voltage and spike noise occur in IC containing switching regulators. Moreover rush current flows at the time of a power supply injection. Because these largely depend on the inductor, the capacitor and impedance of power supply used, perform sufficient evaluation with actual application.
- The 0.1 μF capacitor connected between the VOUT and VSS pins is a bypass capacitor. It stabilizes the power supply in the IC when application is used with a heavy load, and thus effectively works for stable switching regulator operation. Allocate the bypass capacitor as close to the IC as possible, prioritized over other parts.
- Although the IC contains a static electricity protection circuit, static electricity or voltage that exceeds the limit of the protection circuit should not be applied.
- The power dissipation of the IC greatly varies depending on the size and material of the board to be connected. Perform sufficient evaluation using an actual application before designing.
- SII Semiconductor Corporation claims no responsibility for any disputes arising out of or in connection with any infringement by products including this IC of patents owned by a third party.

■ Application Circuits

Application circuits are examples. They may always not guarantee successful operation.

1. External parts for application circuits

Table 12 Characteristics of External Parts

Part	Part Name	Manufacturer	Characteristics
Inductor	VLF302510	TDK Corporation	2.2 μ H, DCR ^{*1} = 0.084 Ω , I _{MAX} ^{*2} = 1.23 A, L × W × H = 3.0 × 2.5 × 1.0 mm
	VLS201610E		2.2 μ H, DCR ^{*1} = 0.276 Ω , I _{MAX} ^{*2} = 0.94 A, L × W × H = 2.0 × 1.6 × 0.95 mm
	MLP2012S		2.2 μ H, DCR ^{*1} = 0.300 Ω , I _{MAX} ^{*2} = 0.8 A, L × W × H = 2.0 × 1.25 × 1.0 mm
	BRL2518T2R2M	TAIYO YUDEN Co., Ltd.	2.2 μ H, DCR ^{*1} = 0.1755 Ω , I _{MAX} ^{*2} = 0.85 A, L × W × H = 2.5 × 1.8 × 1.2 mm
Diode	CRS02	TOSHIBA CORPORATION	V _F ^{*3} = 0.4 V typ., I _F ^{*4} = 1.0 A, V _R ^{*5} = 30 V, L × W × H = 3.5 × 1.6 × 1.08 mm
	CRS08		V _F ^{*3} = 0.32 V typ., I _F ^{*4} = 1.5 A, V _R ^{*5} = 30 V, L × W × H = 3.5 × 1.6 × 1.08 mm
	RB070M-30TR	ROHM Co., Ltd.	V _F ^{*3} = 0.44 V typ., I _F ^{*4} = 1.5 A, V _R ^{*5} = 30 V, L × W × H = 3.5 × 1.6 × 0.9 mm
	RB051LA-40TR		V _F ^{*3} = 0.35 V max., I _F ^{*4} = 3.0 A, V _R ^{*5} = 20 V, L × W × H = 4.7 × 2.6 × 1.05 mm
	RB161M-20TR		V _F ^{*3} = 0.31 V typ., I _F ^{*4} = 1.0 A, V _R ^{*5} = 20 V, L × W × H = 3.5 × 1.6 × 0.9 mm
	RB161SS-20T2R		V _F ^{*3} = 0.42 V, I _F ^{*4} = 3.0 A, V _R ^{*5} = 20 V, L × W × H = 1.6 × 0.8 × 0.603 mm
Capacitor	LMK212BJ106KD	TAIYO YUDEN Co., Ltd.	10 μ F, E _{DC} ^{*6} = 10 V, X5R, L × W × H = 2.0 × 1.25 × 0.95 mm
	EMK107B7105KA		10 μ F, E _{DC} ^{*6} = 16 V, X7R, L × W × H = 1.6 × 0.8 × 0.90 mm
	C1608X5R0J106M	TDK Corporation	10 μ F, E _{DC} ^{*6} = 6.3 V, X5R, L × W × H = 1.6 × 0.8 × 0.9 mm
	C1608X7R1C105K		1 μ F, E _{DC} ^{*6} = 16 V, X7R, L × W × H = 1.6 × 0.8 × 0.9 mm

- * 1. DCR : DC resistance
- * 2. I_{MAX} : Maximum allowable current
- * 3. V_F : Forward voltage
- * 4. I_F : Forward current
- * 5. V_R : Reverse voltage
- * 6. E_{DC} : Rated voltage

2. A power supply started by 0.9 V

Following shows a power supply example which starts up by using the final voltage (0.9 V) of dry cells and its characteristics.

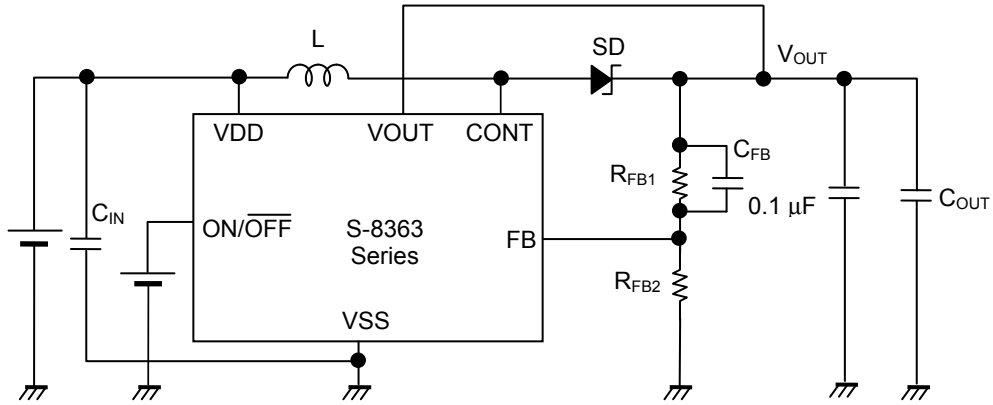

Figure 19 Circuit Example (For a power supply started by 0.9 V)

Table 13 External Parts Examples (For a power supply started by 0.9 V)

Condition	Output Voltage	IC Product Name	L Product Name	SD Product Name	C _{OUT} Product Name	R _{FB1}	R _{FB2}	C _{FB}
1	3.3 V	S-8363B	VLF302510	RB161M-20TR	LMK212BJ106KD	68 kΩ	15 kΩ	47 pF
2	3.3 V	S-8363B	VLF302510	RB051LA-40TR	LMK212BJ106KD	68 kΩ	15 kΩ	47 pF
3	3.3 V	S-8363B	VLF302510	RB070M-30TR	LMK212BJ106KD	68 kΩ	15 kΩ	47 pF
4	3.3 V	S-8363B	VLF302510	RB161SS-20T2R	LMK212BJ106KD	68 kΩ	15 kΩ	47 pF
5	3.3 V	S-8363B	VLF302510	CRS02	LMK212BJ106KD	68 kΩ	15 kΩ	47 pF
6	3.3 V	S-8363B	VLF302510	CRS08	LMK212BJ106KD	68 kΩ	15 kΩ	47 pF

Caution The above connection will not guarantee successful operation. Perform thorough evaluation using an actual application to set the constant.

3. Output characteristics of power supply started by 0.9 V

Following shows the (1) Load current (I_{OUT}) vs. Operating start voltage (V_{ST}), (2) Temperature (T_a) vs. Operating start voltage (V_{ST}), (3) Load current (I_{OUT}) vs. Efficiency (η), (4) Load current (I_{OUT}) vs. Output voltage (V_{OUT}), characteristics for conditions 1 to 6 in **Table 13**.

(1) Load current (I_{OUT}) vs. Operating start voltage (V_{ST})

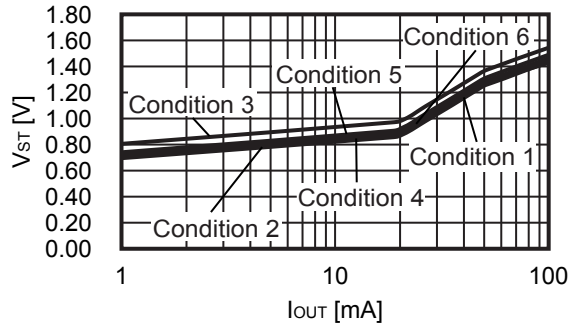

(2) Temperature (T_a) vs. Operating start voltage (V_{ST})

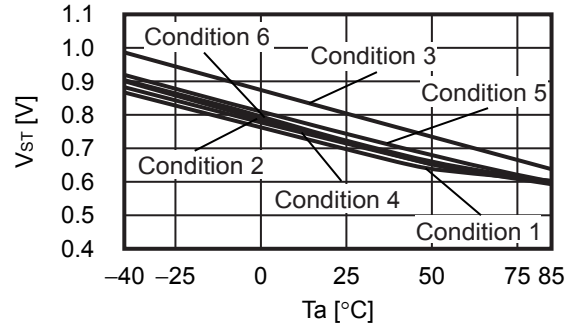

(3) Load current (I_{OUT}) vs. Efficiency (η)

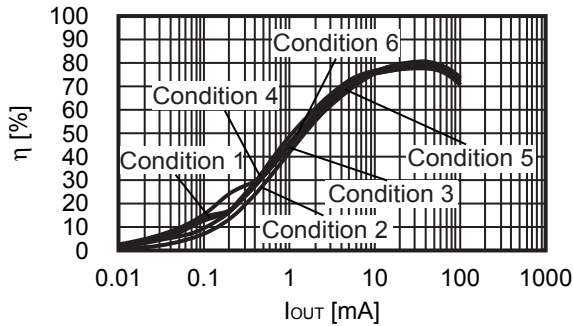

(4) Load current (I_{OUT}) vs. Output voltage (V_{OUT})

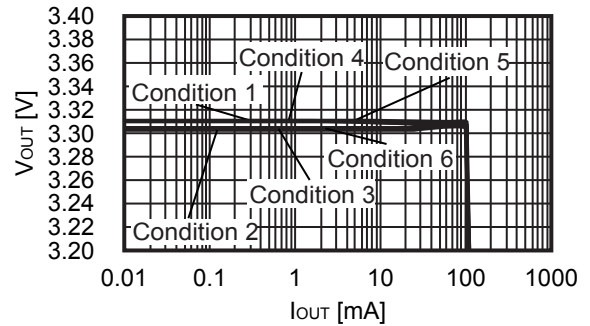

4. Super-small power supply

Following shows a circuit example which gives top priority to reduce the implementation area by using the small external parts and its characteristics.

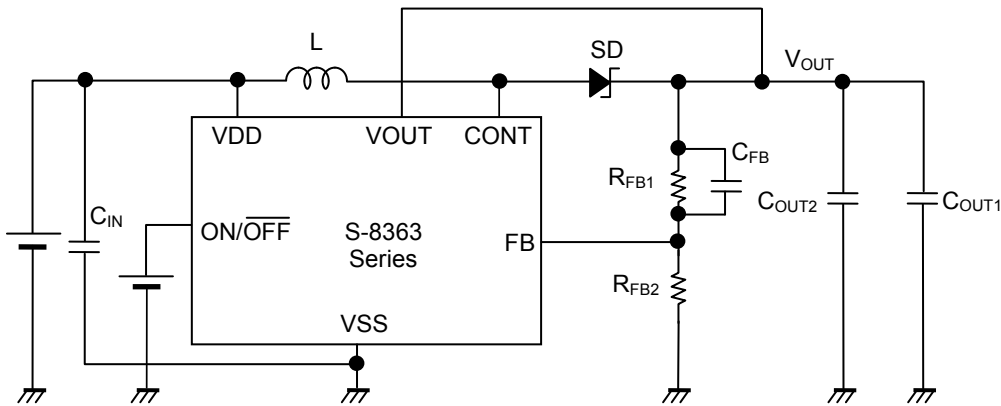

Figure 20 Circuit Example (For super-small power supply)

Table 14 External Parts Examples (For super-small power supply)

Condition	Output Voltage	IC Product Name	L Product Name	SD Product Name	C _{OUT1}	C _{OUT2}	R _{FB1}	R _{FB2}	C _{FB}
1	1.8 V	S-8363B	MLP2012S	RB161SS-20	C1608X5R0J106M	C1608X5R0J106M	30 kΩ	15 kΩ	82 pF
2	3.3 V	S-8363B	MLP2012S	RB161SS-20	LMK212BJ106KD	0.1 μF	68 kΩ	15 kΩ	47 pF
3	1.8 V	S-8363B	VLS201610E	RB161SS-20	C1608X5R0J106M	C1608X5R0J106M	30 kΩ	15 kΩ	82 pF
4	3.3 V	S-8363B	VLS201610E	RB161SS-20	LMK212BJ106KD	0.1 μF	68 kΩ	15 kΩ	47 pF
5	1.8 V	S-8363B	BRL2518T2R2M	RB161SS-20	C1608X5R0J106M	C1608X5R0J106M	30 kΩ	15 kΩ	82 pF
6	3.3 V	S-8363B	BRL2518T2R2M	RB161SS-20	LMK212BJ106KD	0.1 μF	68 kΩ	15 kΩ	47 pF

Caution The above connection will not guarantee successful operation. Perform thorough evaluation using an actual application to set the constant.

5. Output characteristics of super-small power supply

Following shows the output current (I_{OUT}) vs. efficiency (η), output current (I_{OUT}) vs. output voltage (V_{OUT}), and output current (I_{OUT}) vs. ripple voltage (V_r) characteristics for conditions 1 to 6 in **Table 14**.

Condition 1

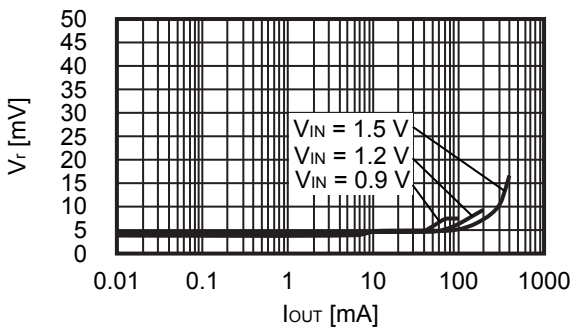
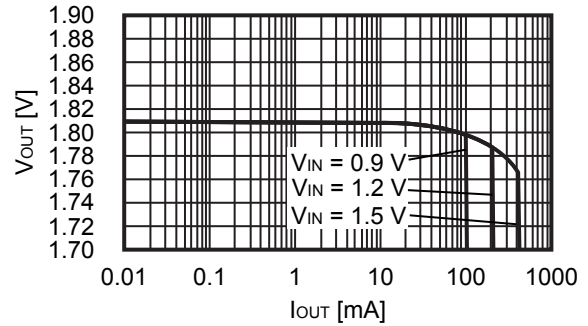
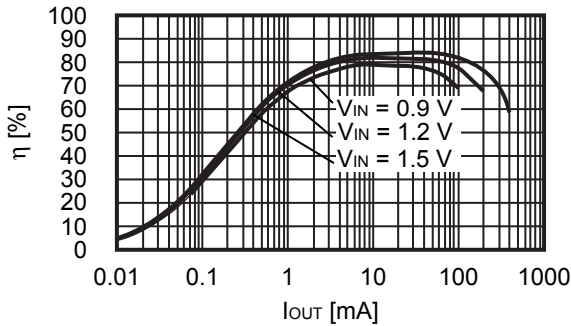

Condition 2

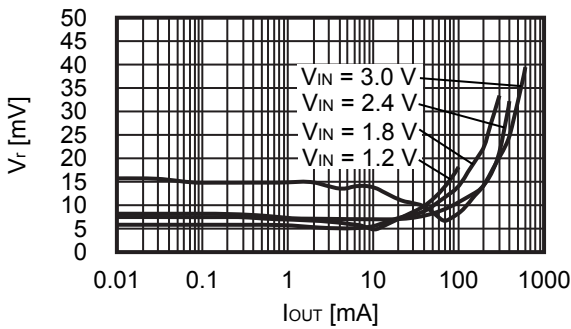
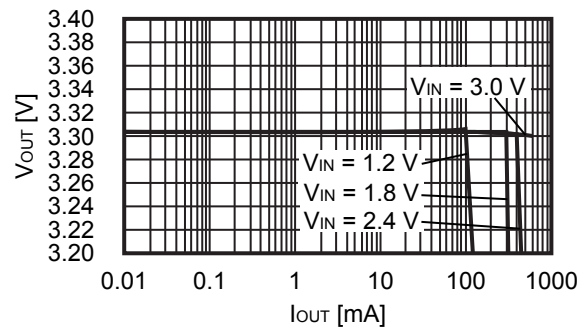
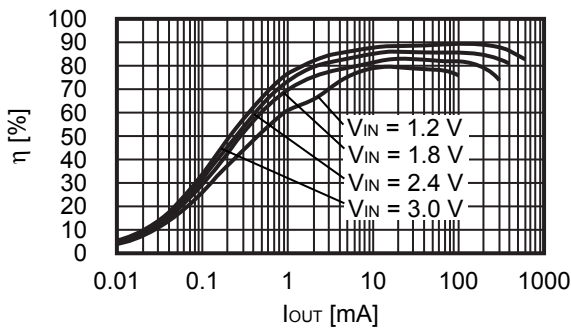

Condition 3

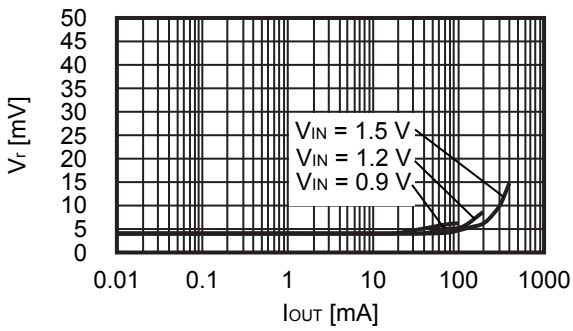
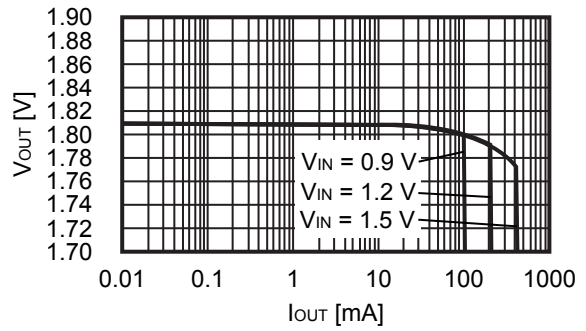
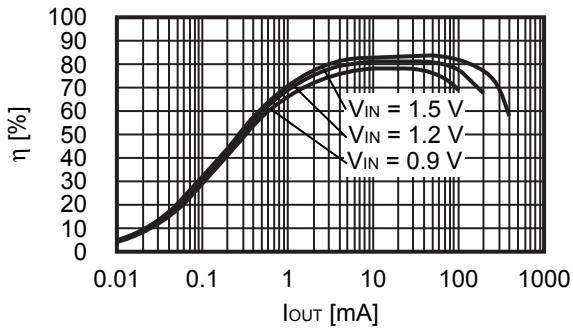

Condition 4

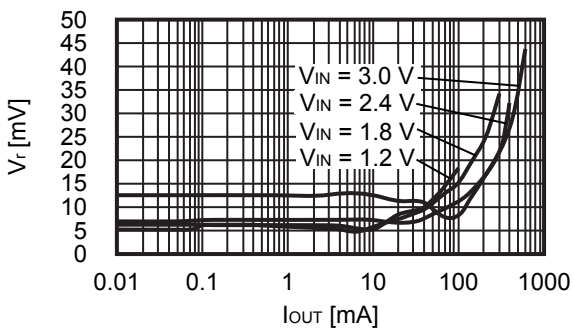
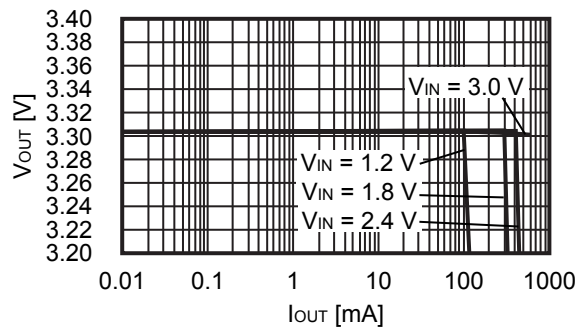
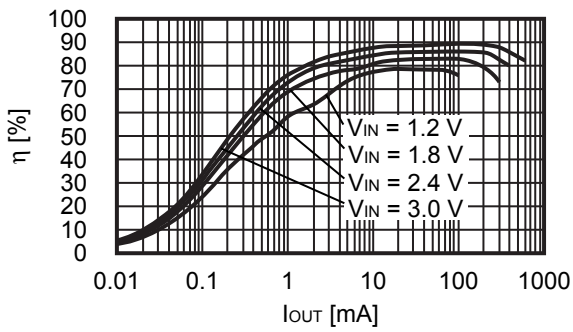

Condition 5

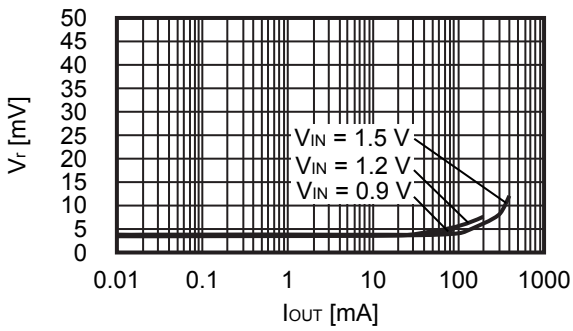
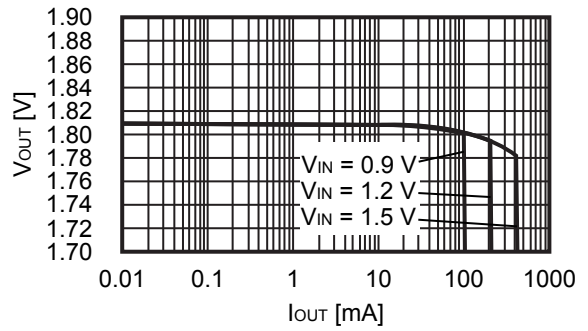
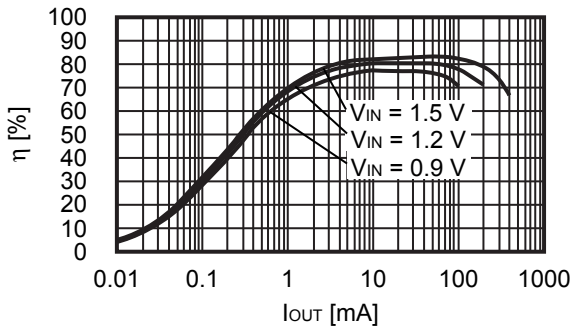

Condition 6

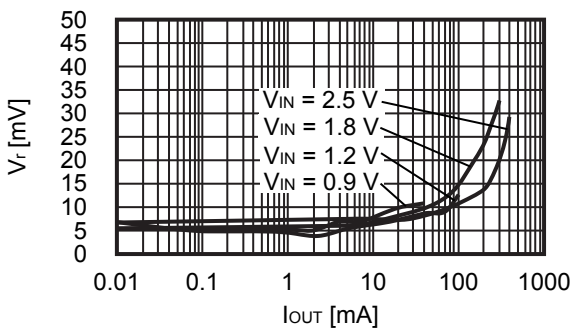
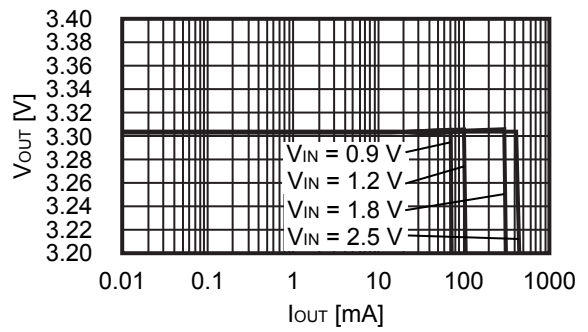
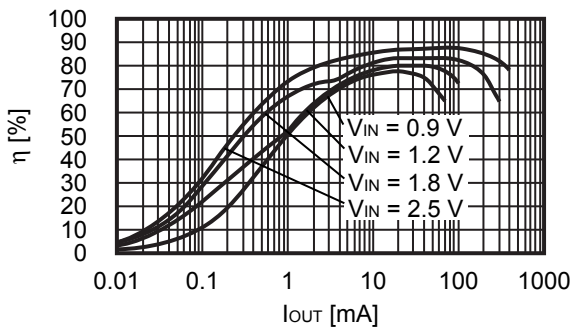

■ Characteristics (Typical Data)

1. Examples of Major Power Supply Dependence Characteristics (Ta = +25°C)

(1) Current consumption during operation (I_{IN1}) vs. Operating input voltage (V_{IN})
 Current consumption during switching off (I_{IN2}) vs. Operating input voltage (V_{IN})

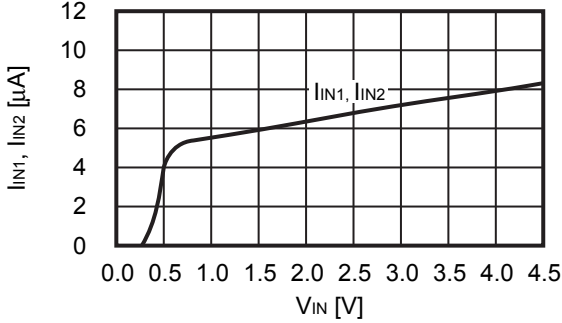

(2) Current consumption during operation (I_{SS1}) vs. Output voltage (V_{OUT})
 Current consumption during switching off (I_{SS2}) vs. Output voltage (V_{OUT})

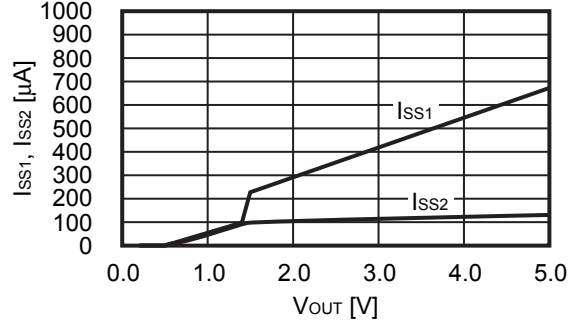

(3) Current consumption during power-off (I_{SS3}) vs. Operating input voltage (V_{IN}), Output voltage (V_{OUT})

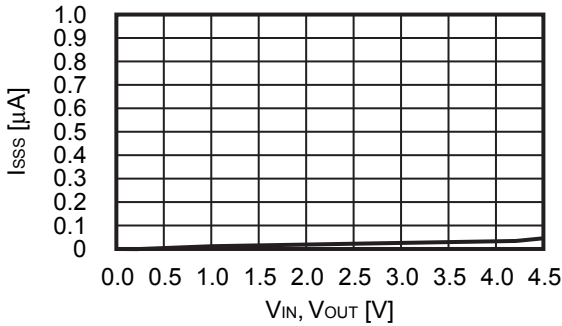

(4) Oscillation frequency (f_{OSC}) vs. Output voltage (V_{OUT})

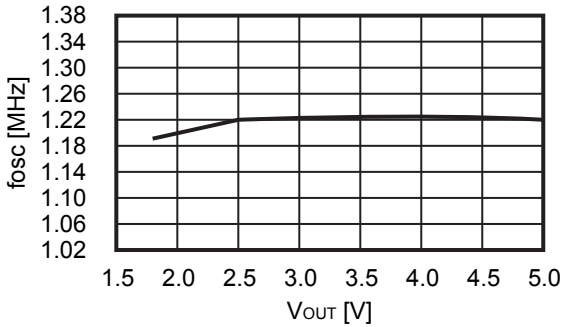

(5) Start-up oscillation frequency (f_{ST}) vs. Operating input voltage (V_{IN})

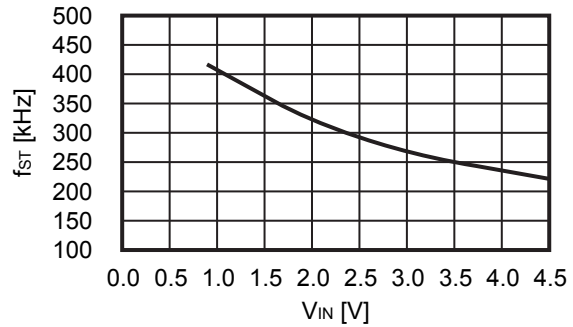

(6) Maximum duty ratio (MaxDuty) vs. Output voltage (V_{OUT})

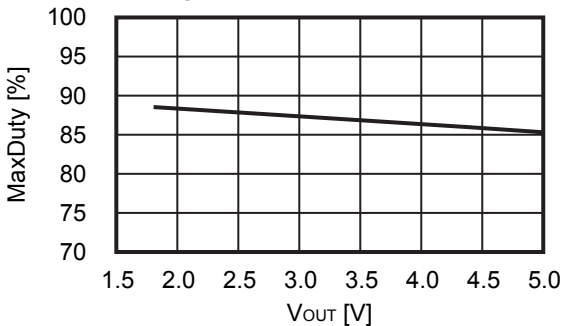

(7) Soft-start time (t_{SS}) vs. Output voltage (V_{OUT})

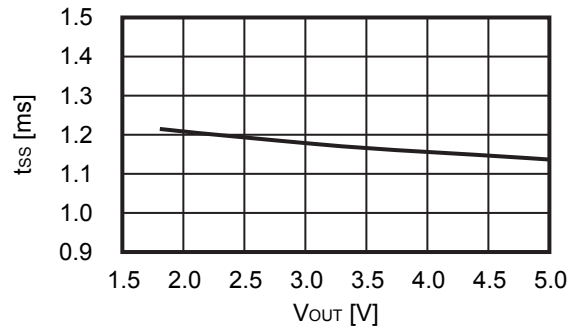

(8) PWM / PFM switching duty ratio (PFMDuty) vs. Operating input voltage (V_{IN})

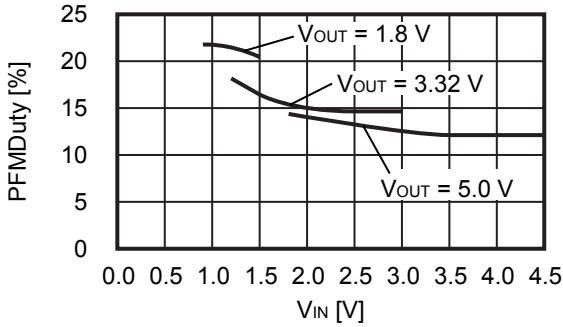

(9) Output current at PWM / PFM switching (I_{PFM}) vs. Operating input voltage (V_{IN})

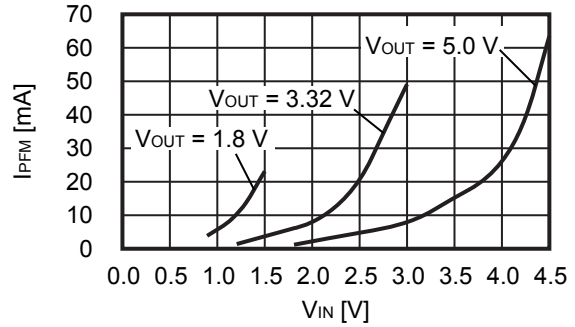

(10) Limited current (I_{LIM}) vs. Operating input voltage (V_{IN})

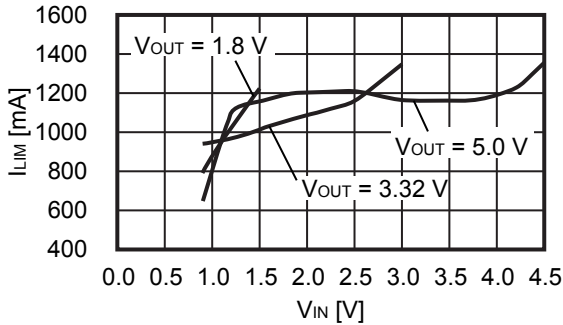

(11) Maximum load current (I_{OUTMAX}) vs. Operating input voltage (V_{IN})

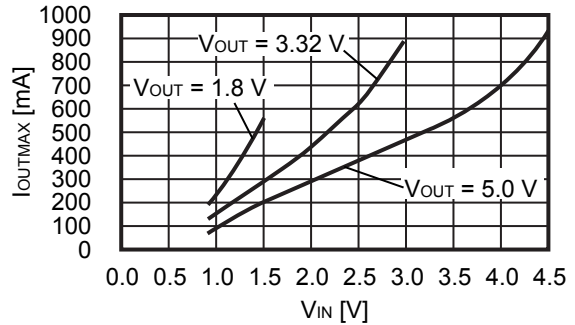

(12) Power MOS FET leakage current (I_{LSW}) vs. Output voltage (V_{OUT})

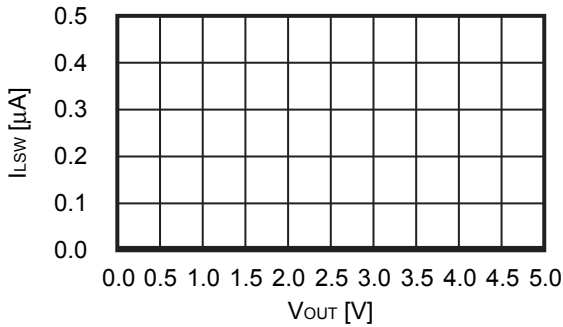

(13) High level input voltage (V_{SH}) vs. Operating input voltage (V_{IN})

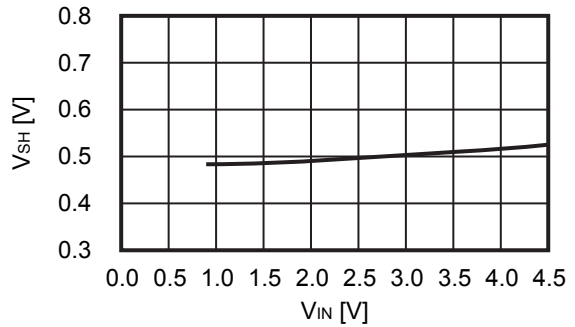

(14) Low level input voltage (V_{SL}) vs. Operating input voltage (V_{IN})

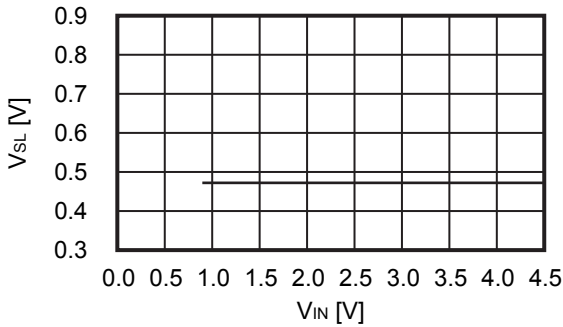

(15) FB voltage (V_{FB}) vs. Output voltage (V_{OUT})

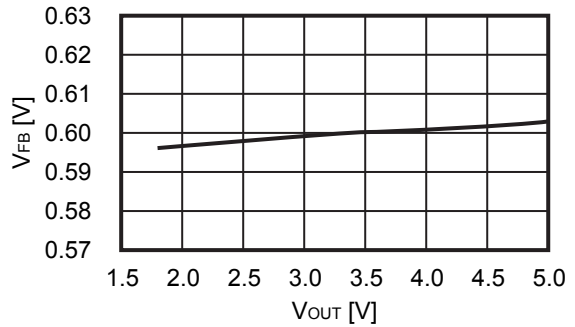

2. Examples of Major Temperature Characteristics ($T_a = -40$ to $+85^\circ\text{C}$)

(1) Current consumption during operation (I_{IN1}) vs. Temperature (T_a)

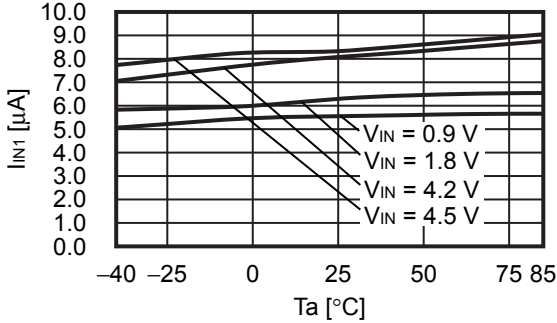

(2) Current consumption during operation (I_{SS1}) vs. Temperature (T_a)

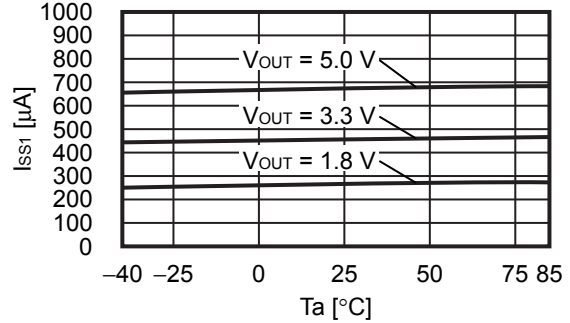

(3) Current consumption during switching off (I_{IN2}) vs. Temperature (T_a)

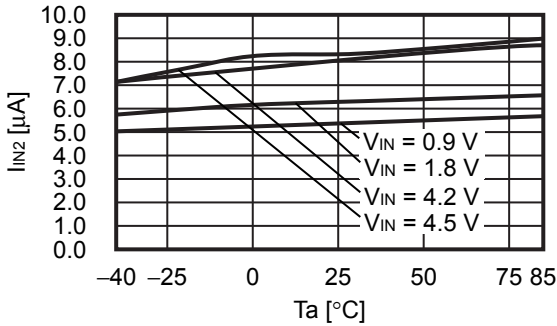

(4) Current consumption during switching off (I_{SS2}) vs. Temperature (T_a)

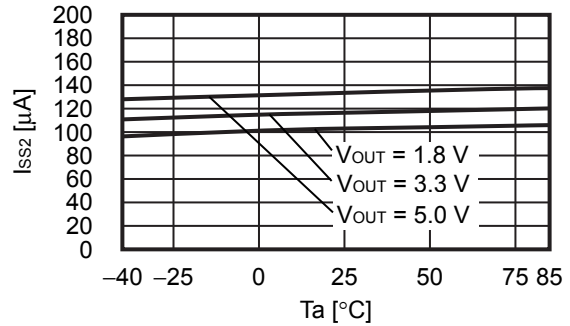

(5) Current consumption during power-off (I_{SS3}) vs. Temperature (T_a)

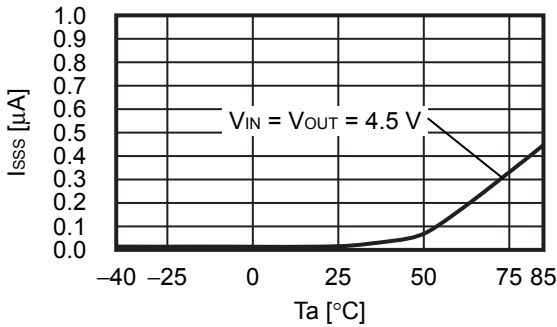

(6) Oscillation frequency (f_{OSC}) vs. Temperature (T_a)

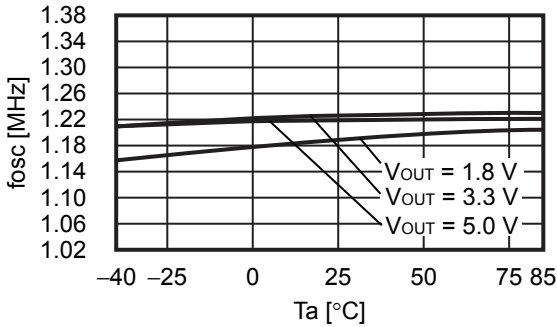

(7) Start-up oscillation frequency (f_{ST}) vs. Temperature (T_a)

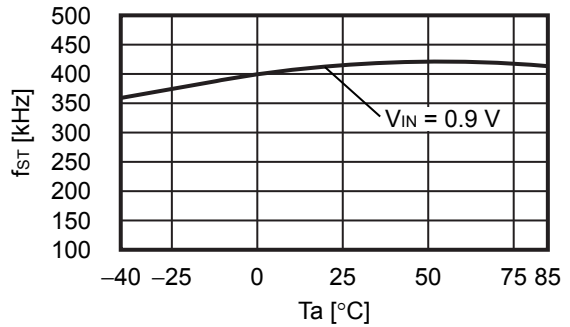

(8) Maximum duty ratio (MaxDuty) vs. Temperature (Ta)

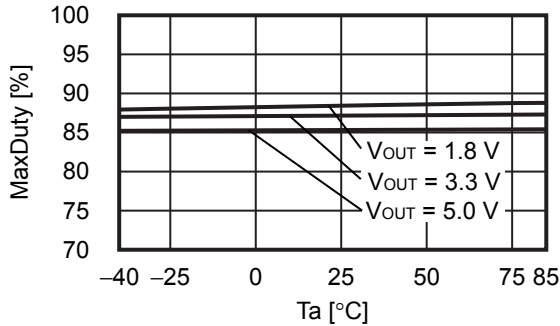

(9) Soft-start time (t_{ss}) vs. Temperature (Ta)

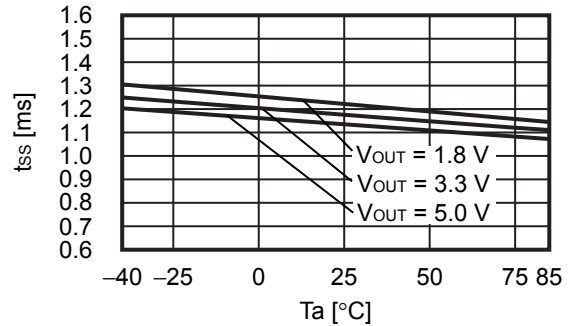

(10) PWM / PFM switching duty ratio (PFMDuty) vs. Temperature (Ta)

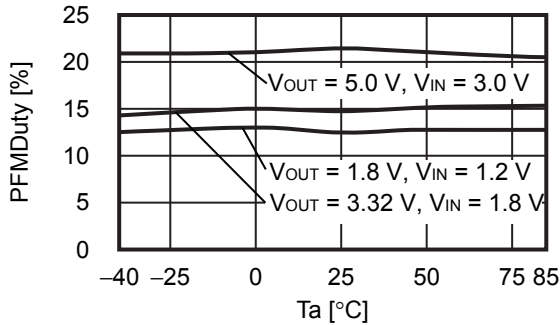

(11) Output current at PWM / PFM switching (I_{PFM}) vs. Temperature (Ta)

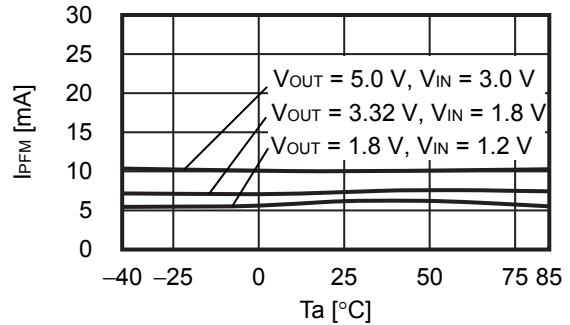

(12) Limited current (I_{LIM}) vs. Temperature (Ta)

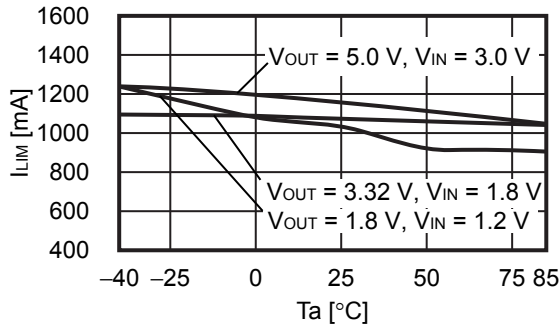

(13) Maximum load current (I_{OUTMAX}) vs. Temperature (Ta)

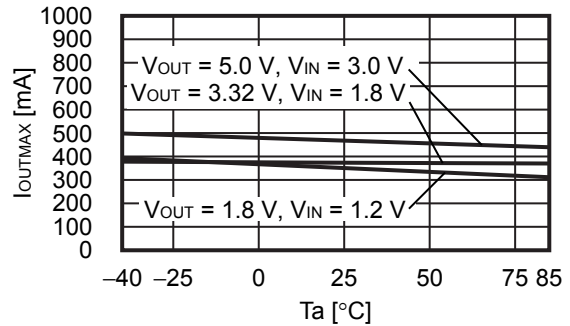

(14) Power MOS FET leakage current (I_{LSW}) vs. Temperature (Ta)

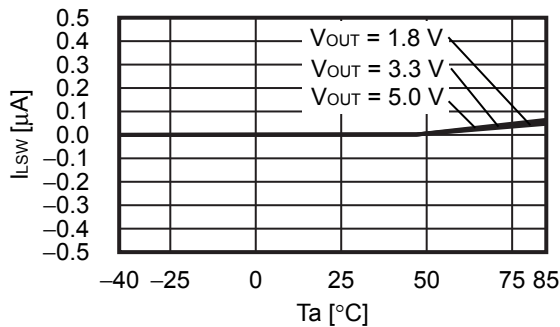

(15) High level input voltage (V_{SH}) vs. Temperature (Ta)

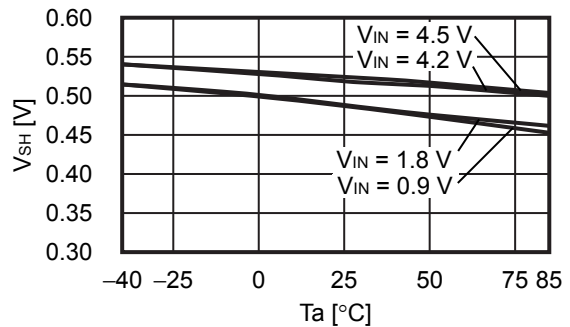

(16) Low level input voltage (V_{SL}) vs Temperature (T_a)

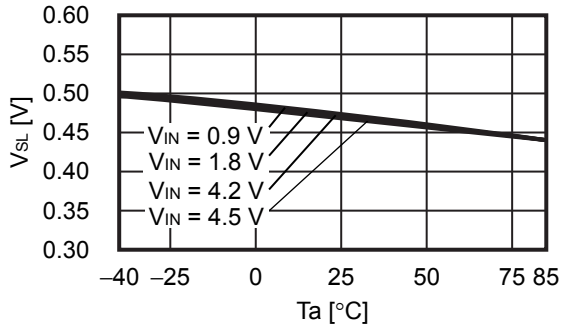

(17) FB voltage (V_{FB}) vs. Temperature (T_a)

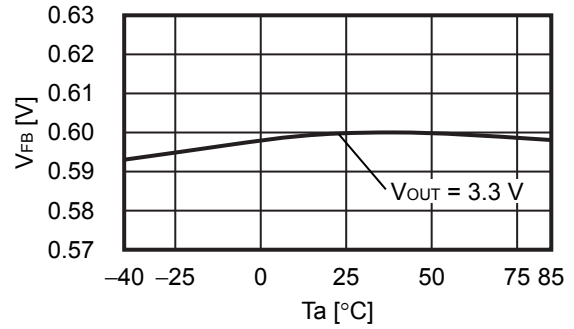

(18) Operating start voltage (V_{ST}) vs. Temperature (T_a)

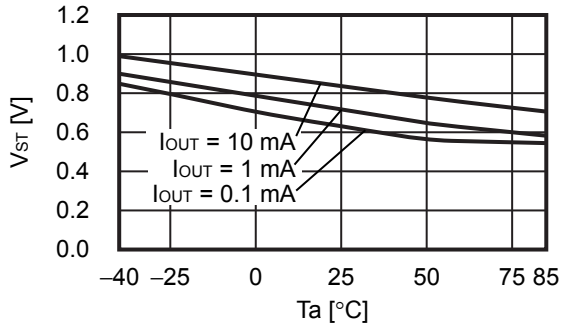

(19) Start-up mode release voltage (V_{STU+}) vs. Temperature (T_a)

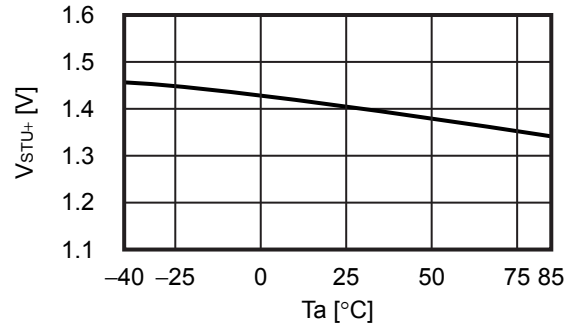

3. Output waveform

(1) $V_{OUT} = 3.3\text{ V}$ ($V_{IN} = 1.98\text{ V}$)

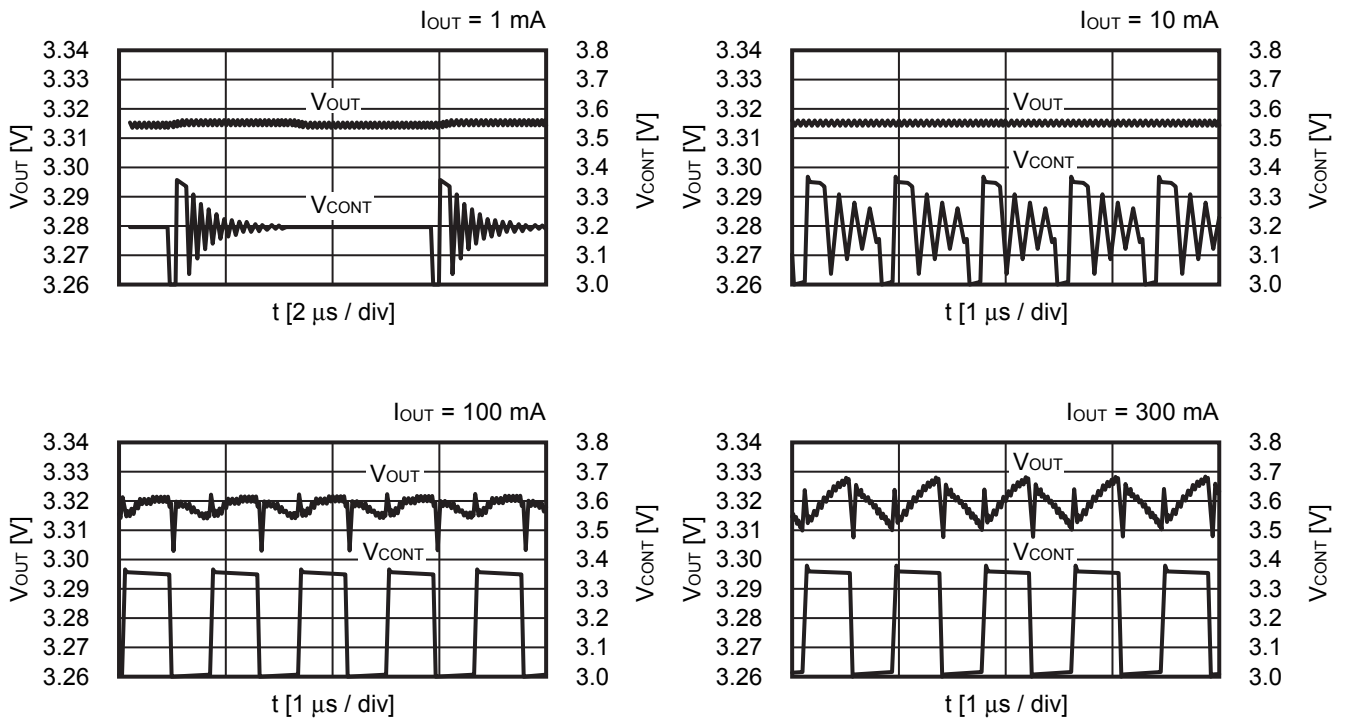

(2) $V_{OUT} = 5.0\text{ V}$ ($V_{IN} = 3.0\text{ V}$)

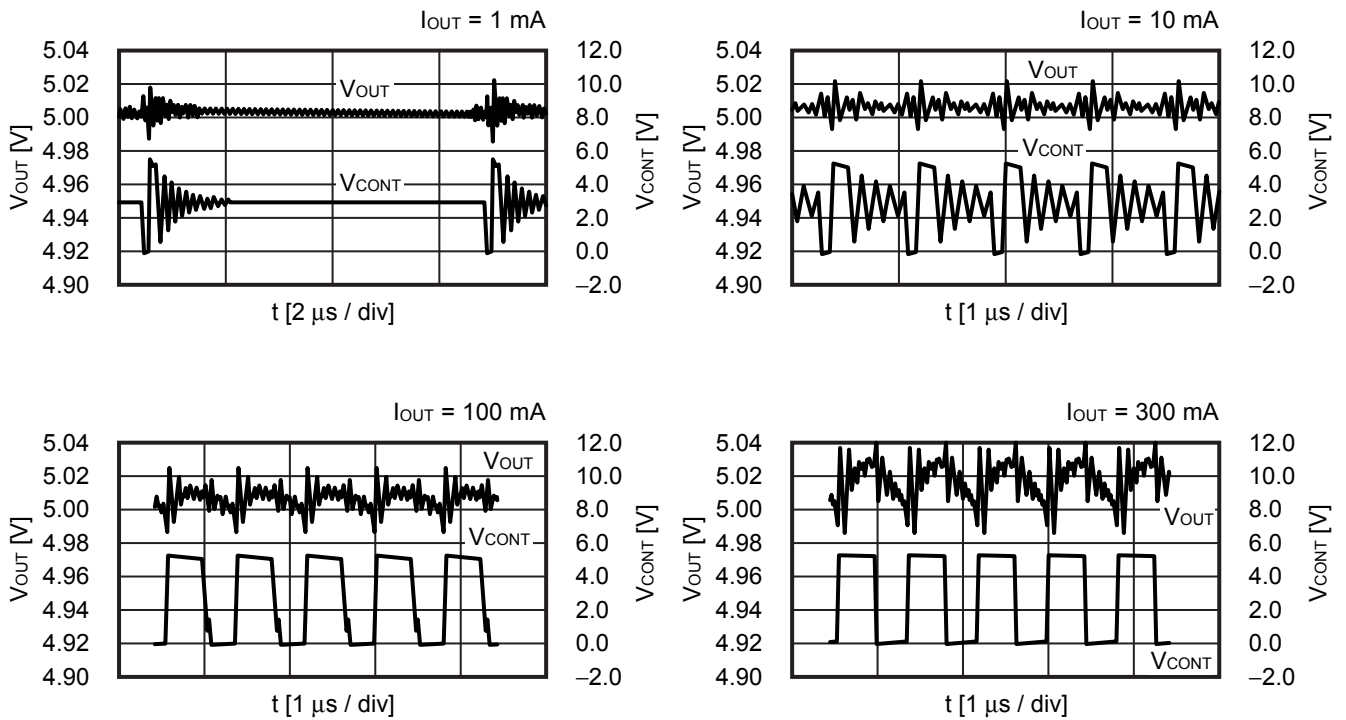

4. Examples of Transient Response Characteristics

Unless otherwise specified, the used parts are those in **Table 6 External Parts List**.

4.1 At power-on ($V_{OUT(S)} = 3.3\text{ V}$, $V_{IN} = 0\text{ V} \rightarrow 0.9\text{ V}$, $T_a = +25^\circ\text{C}$)

(1) $I_{OUT} = 1\text{ mA}$

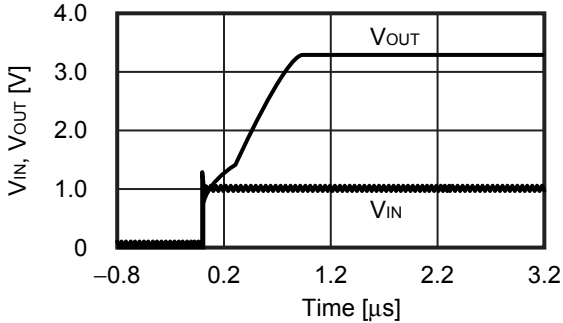

4.2 At power-on ($V_{OUT(S)} = 3.3\text{ V}$, $V_{IN} = 0\text{ V} \rightarrow 2.0\text{ V}$, $T_a = +25^\circ\text{C}$)

(1) $I_{OUT} = 1\text{ mA}$

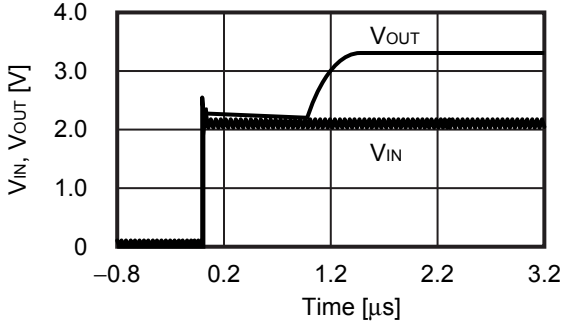

(2) $I_{OUT} = 300\text{ mA}$

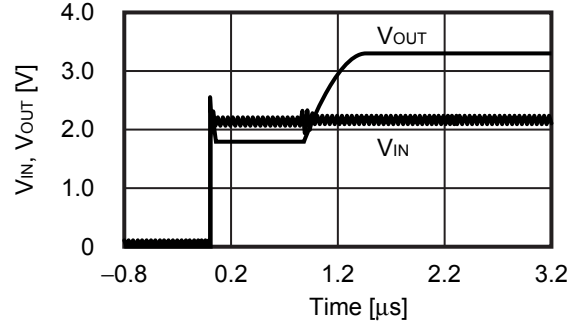

4.3 Power-off pin response ($V_{OUT} = 3.3\text{ V}$, $V_{IN} = 0.9\text{ V}$, $V_{ON/OFF} = 0\text{ V} \rightarrow 0.9\text{ V}$, $T_a = +25^\circ\text{C}$)

(1) $I_{OUT} = 1\text{ mA}$

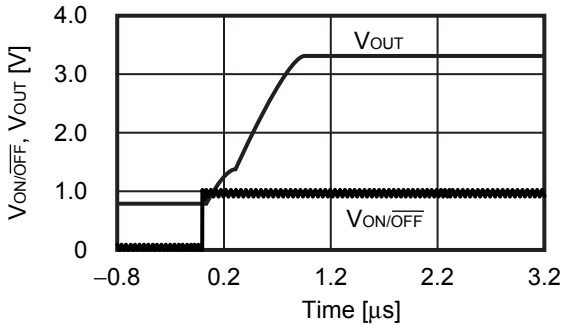

4.4 Power-off pin response ($V_{OUT} = 3.3\text{ V}$, $V_{IN} = 2.0\text{ V}$, $V_{ON/OFF} = 0\text{ V} \rightarrow 2.0\text{ V}$, $T_a = +25^\circ\text{C}$)

(1) $I_{OUT} = 1\text{ mA}$

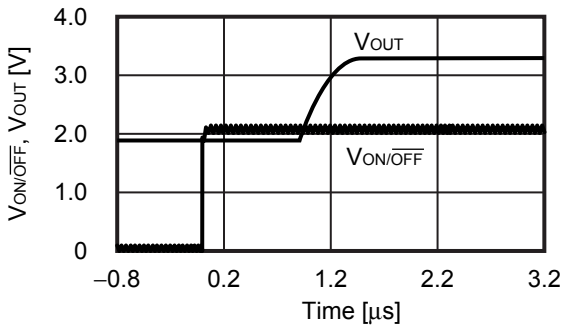

(2) $I_{OUT} = 300\text{ mA}$

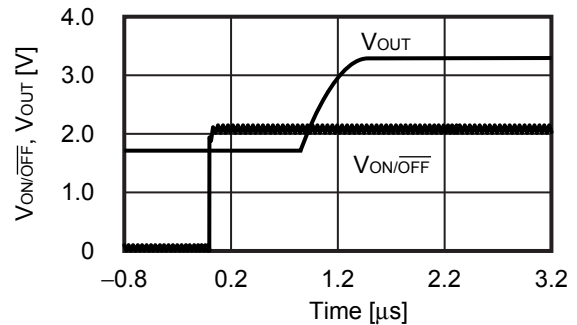

4.5 Power supply voltage fluctuations ($V_{OUT} = 3.0\text{ V}$, $I_{OUT} = 100\text{ mA}$, $T_a = +25^\circ\text{C}$)

(1) $V_{IN} = 1.98\text{ V} \rightarrow 2.64\text{ V}$

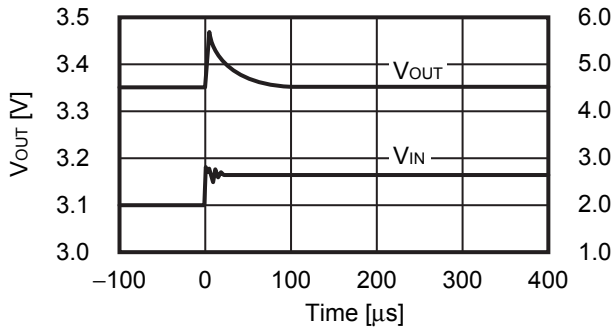

(2) $V_{IN} = 2.64\text{ V} \rightarrow 1.98\text{ V}$

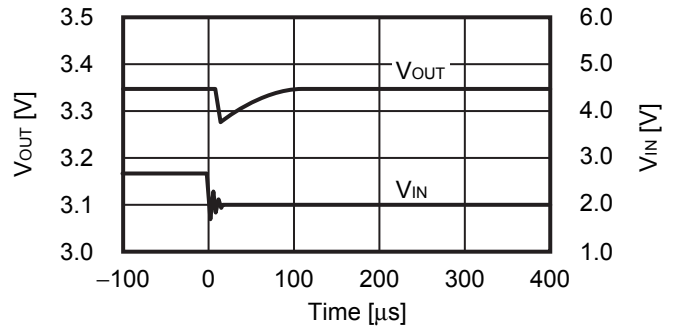

4.6 Load fluctuations ($V_{OUT} = 3.3\text{ V}$, $V_{IN} = 1.98\text{ V}$, $I_{OUT} = 0.1\text{ mA} \rightarrow 100\text{ mA} \rightarrow 0.1\text{ mA}$, $T_a = +25^\circ\text{C}$)

(1) $I_{OUT} = 0.1\text{ mA} \rightarrow 100\text{ mA}$

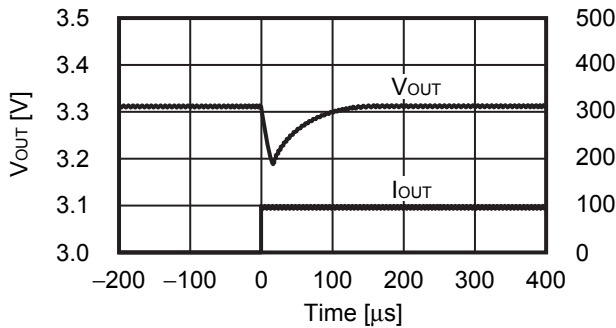

(2) $I_{OUT} = 100\text{ mA} \rightarrow 0.1\text{ mA}$

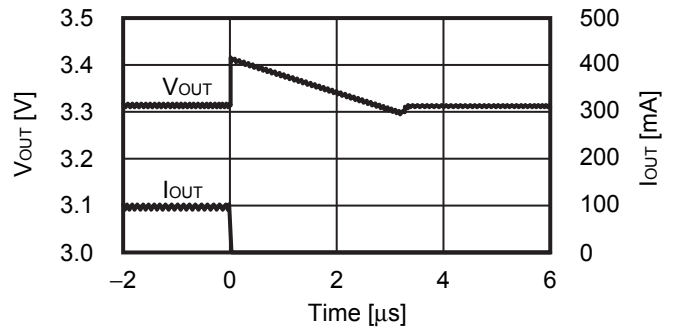

4.7 Load fluctuations ($V_{OUT} = 3.3\text{ V}$, $V_{IN} = 1.98\text{ V}$, $I_{OUT} = 100\text{ mA} \rightarrow 200\text{ mA} \rightarrow 100\text{ mA}$, $T_a = +25^\circ\text{C}$)

(1) $I_{OUT} = 100\text{ mA} \rightarrow 200\text{ mA}$

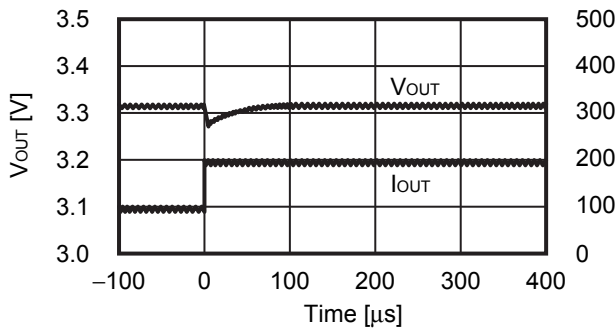

(2) $I_{OUT} = 200\text{ mA} \rightarrow 100\text{ mA}$

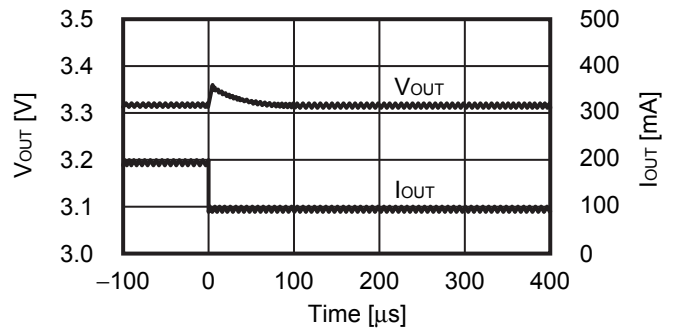

■ **Reference Data**

Reference data is provided to determine specific external components. Therefore, the following data shows the characteristics of the recommended external components selected for various applications.

1. External parts

Table 15 Efficiency vs. Output Current Characteristics and Output Voltage vs. Output Current Characteristics for External Parts (1 / 2)

Condition	Product Name	Output Voltage	L Product Name	SD Product Name	C _{IN}
1	S-8363B	1.8 V	VLF302510	CRS08	C1608X7R1C105K
2	S-8363B	3.3 V	VLF302510	CRS08	EMK107B7105KA
3	S-8363B	5.0 V	VLF302510	CRS08	EMK107B7105KA
4	S-8363B	3.3 V	VLF302510	CRS08	C1608X7R1C105K
5	S-8363B	3.3 V	VLF302510	CRS08	C1608X7R1C105K
6	S-8363B	3.3 V	VLF302510	RB070M-30TR	EMK107B7105KA
7	S-8363B	3.3 V	VLF302510	RB051LA-40TR	EMK107B7105KA

Table 15 Efficiency vs. Output Current Characteristics and Output Voltage vs. Output Current Characteristics for External Parts (2 / 2)

Condition	C _{OUT1}	C _{OUT2}	C _{OUT3}	R _{FB1}	R _{FB2}	C _{FB}
1	C1608X5R0J106M	C1608X5R0J106M	—	30 kΩ	15 kΩ	82 pF
2	LMK212BJ106KD	0.1 μF	—	68 kΩ	15 kΩ	47 pF
3	LMK212BJ106KD	0.1 μF	—	110 kΩ	15 kΩ	38 pF
4	C1608X5R0J106M	C1608X5R0J106M	—	68 kΩ	15 kΩ	47 pF
5	C1608X5R0J106M	C1608X5R0J106M	C1608X5R0J106M	68 kΩ	15 kΩ	47 pF
6	LMK212BJ106KD	0.1 μF	—	68 kΩ	15 kΩ	47 pF
7	LMK212BJ106KD	0.1 μF	—	68 kΩ	15 kΩ	47 pF

The properties of the external parts are shown below.

Table 16 Characteristics of External Parts

Part	Part Name	Manufacturer	Characteristics
Inductor	VLF302510	TDK Corporation	2.2 μ H, DCR ^{*1} = 0.084 Ω , I _{MAX} ^{*2} = 1.23 A, L \times W \times H = 3.0 \times 2.5 \times 1.0 mm
Diode	CRS08	TOSHIBA CORPORATION	V _F ^{*3} = 0.32 V typ., I _F ^{*4} = 1.5 A, V _R ^{*5} = 30 V, L \times W \times H = 3.5 \times 1.6 \times 1.08 mm
	RB070M-30TR	ROHM Co., Ltd.	V _F ^{*3} = 0.44 V typ., I _F ^{*4} = 1.5 A, V _R ^{*5} = 30 V, L \times W \times H = 3.5 \times 1.6 \times 0.9 mm
	RB051LA-40TR		V _F ^{*3} = 0.35 V max., I _F ^{*4} = 3.0 A, V _R ^{*5} = 20 V, L \times W \times H = 4.7 \times 2.6 \times 1.05 mm
	RB161M-20TR		V _F ^{*3} = 0.31 V typ., I _F ^{*4} = 1.0 A, V _R ^{*5} = 20 V, L \times W \times H = 3.5 \times 1.6 \times 0.9 mm
	RB161SS-20T2R		V _F ^{*3} = 0.42 V, I _F ^{*4} = 1.0 A, V _R ^{*5} = 20 V, L \times W \times H = 1.6 \times 0.8 \times 0.603 mm
Capacitor	LMK212BJ106KD	TAIYO YUDEN Co., Ltd.	10 μ F, E _{DC} ^{*6} = 10 V, X5R, L \times W \times H = 2.0 \times 1.25 \times 0.95 mm
	EMK107B7105KA		10 μ F, E _{DC} ^{*6} = 16 V, X7R, L \times W \times H = 1.6 \times 0.8 \times 0.9 mm
	C1608X5R0J106M	TDK Corporation	10 μ F, E _{DC} ^{*6} = 6.3 V, X5R, L \times W \times H = 1.6 \times 0.8 \times 0.9 mm
	C1608X7R1C105K		1 μ F, E _{DC} ^{*6} = 16 V, X7R, L \times W \times H = 1.6 \times 0.8 \times 0.9 mm

- * 1. DCR : DC resistance
- * 2. I_{MAX} : Maximum allowable current
- * 3. V_F : Forward voltage
- * 4. I_F : Forward current
- * 5. V_R : Reverse voltage
- * 6. E_{DC} : Rated voltage

Caution The values shown in the characteristics column of Table 16 above are based on the materials provided by each manufacture. However, consider the characteristics of the original materials when using the above products.

2. Output Current (I_{OUT}) vs. Efficiency (η) Characteristics, Output Current (I_{OUT}) vs. Output Voltage (V_{OUT}) Characteristics

Following shows the actual output current (I_{OUT}) vs. efficiency (η) and output current (I_{OUT}) vs. output voltage (V_{OUT}) characteristics for conditions 1 to 7 in Table 15.

Condition 1 S-8363B ($V_{OUT(S)} = 1.8\text{ V}$)

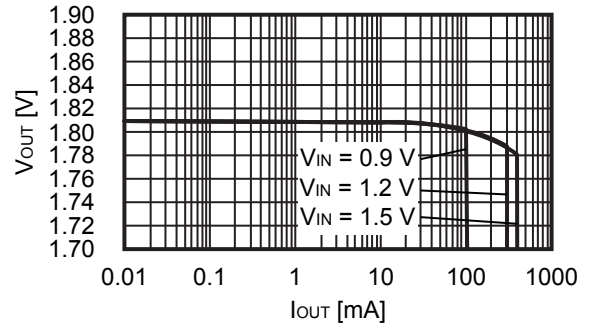
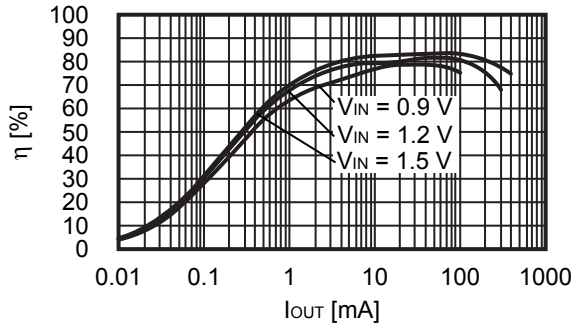

Condition 2 S-8363B ($V_{OUT(S)} = 3.3\text{ V}$)

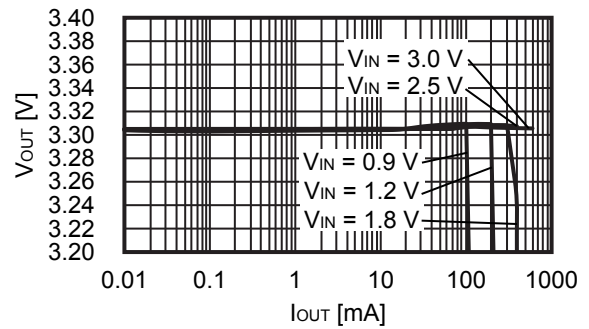
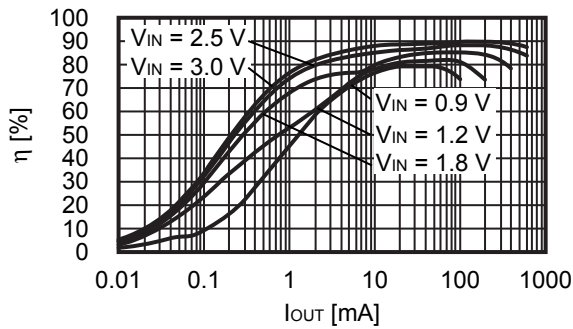

Condition 3 S-8363B ($V_{OUT(S)} = 5.0\text{ V}$)

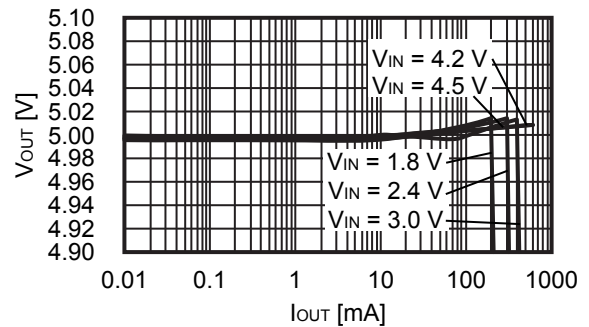
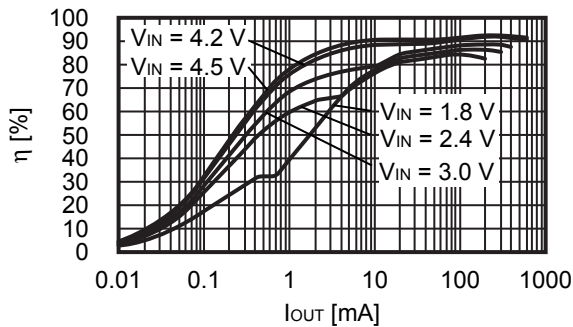

Condition 4 S-8363B ($V_{OUT(S)} = 3.3\text{ V}$)

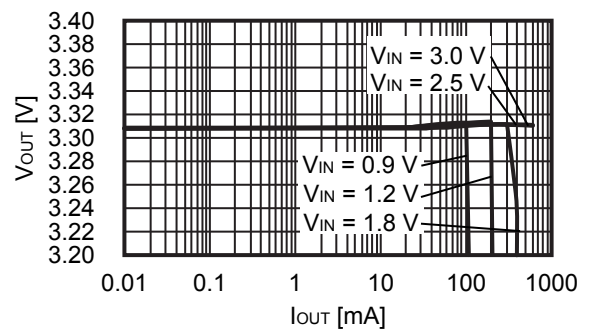
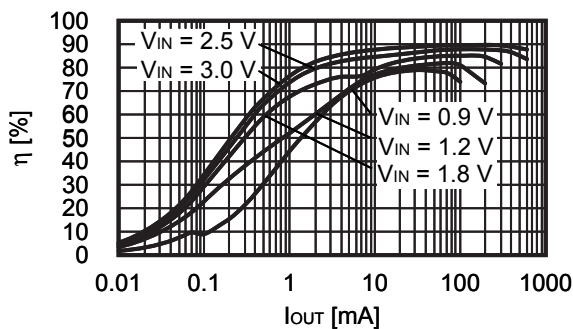

Condition 5 S-8363B ($V_{OUT(S)} = 3.3\text{ V}$)

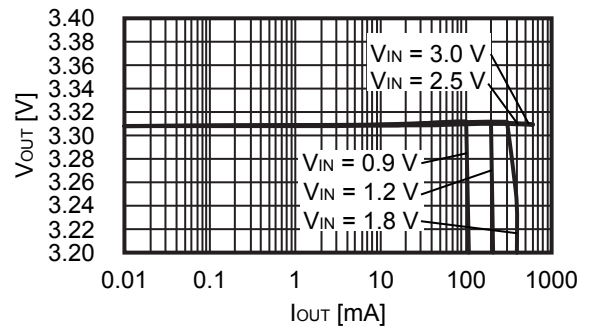
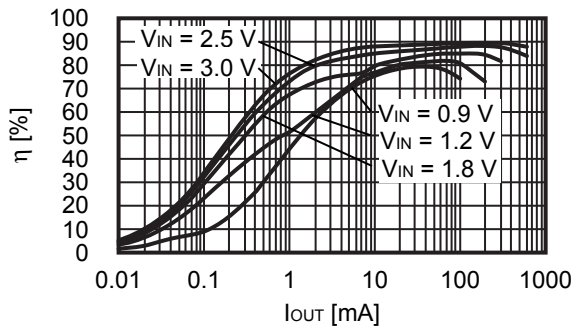

Condition 6 S-8363B ($V_{OUT(S)} = 3.3\text{ V}$)

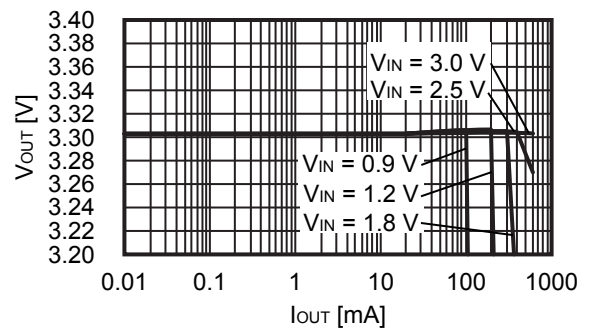
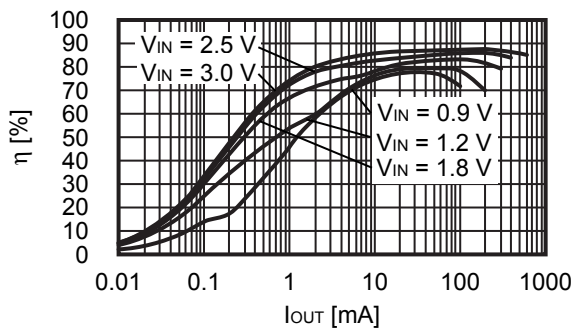

Condition 7 S-8363B ($V_{OUT(S)} = 3.3\text{ V}$)

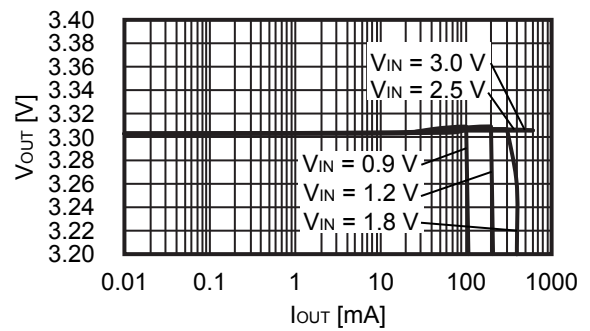
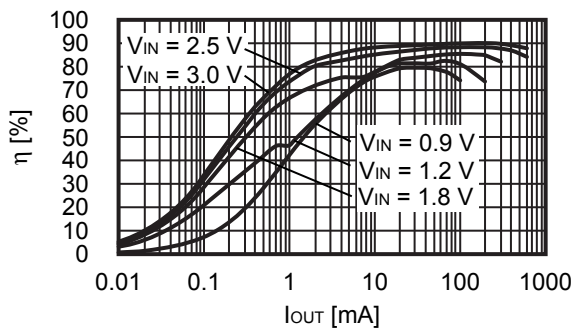

3. Output Current (I_{OUT}) vs. Ripple Voltage (V_r) Characteristics

Following shows the actual output current (I_{OUT}) vs. ripple voltage (V_r) characteristics for conditions of 1 to 7 in Table 15.

Condition 1 S-8363B ($V_{OUT(S)} = 1.8\text{ V}$)

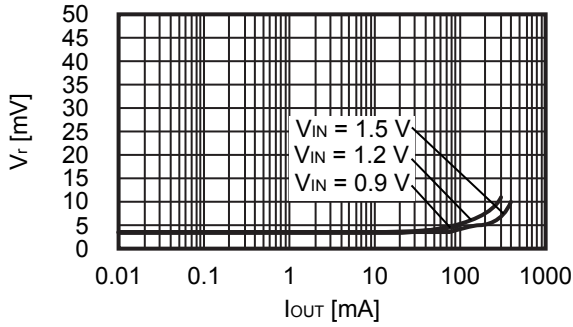

Condition 2 S-8363B ($V_{OUT(S)} = 3.3\text{ V}$)

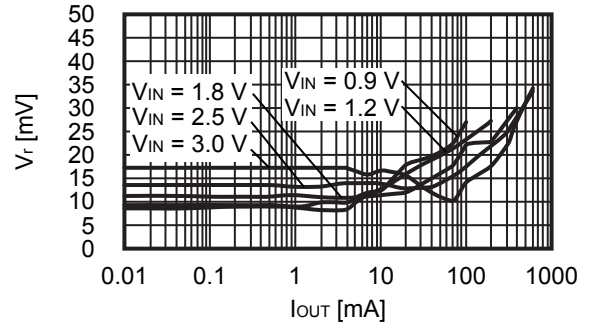

Condition 3 S-8363B ($V_{OUT(S)} = 5.0\text{ V}$)

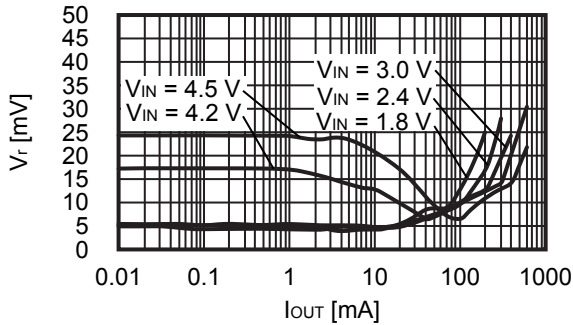

Condition 4 S-8363B ($V_{OUT(S)} = 3.3\text{ V}$)

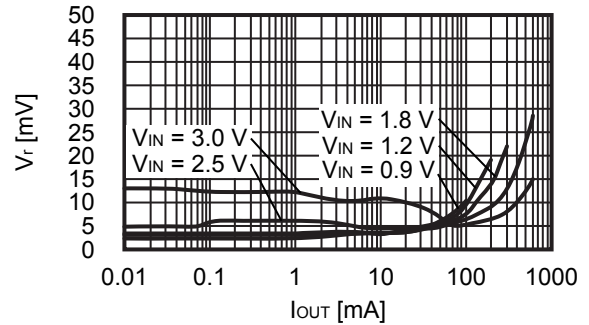

Condition 5 S-8363B ($V_{OUT(S)} = 3.3\text{ V}$)

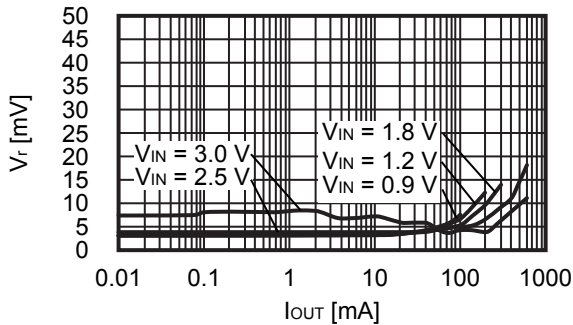

Condition 6 S-8363B ($V_{OUT(S)} = 3.3\text{ V}$)

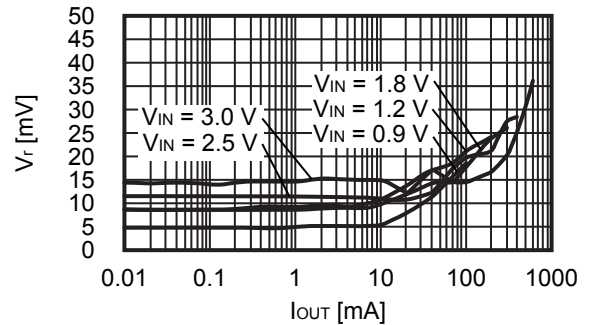

Condition 7 S-8363B ($V_{OUT(S)} = 3.3\text{ V}$)

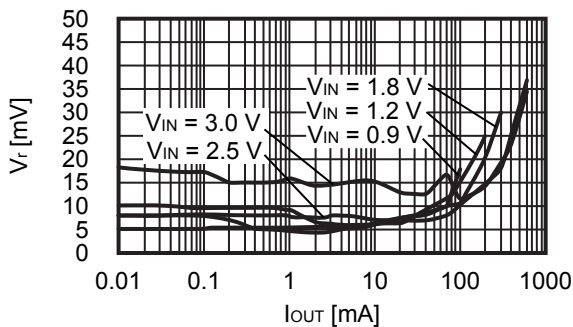

■ **Marking Specification**

(1) **SNT-6A**

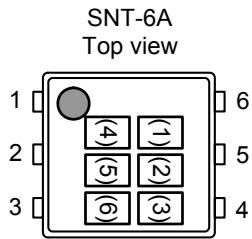

(1) to (3) : Product code (Refer to Product name vs. Product code)
 (4) to (6) : Lot number

Product name vs. Product code

Product name	Product code		
	(1)	(2)	(3)
S-8363B-I6T1U2	I	9	B

(2) **SOT-23-6**

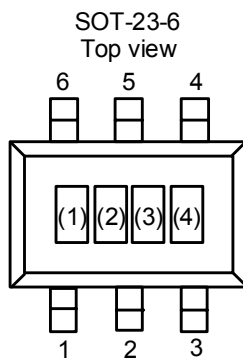

(1) to (3) : Product code (Refer to Product name vs. Product code)
 (4) : Lot number

Product name vs. Product code

Product name	Product code		
	(1)	(2)	(3)
S-8363B-M6T1U2	I	9	B

Remark Please select products of environmental code = U for Sn 100%, halogen-free products.

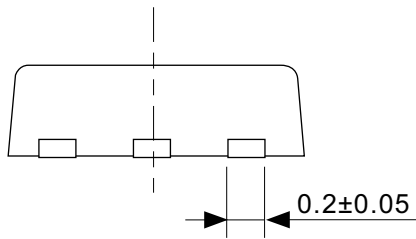
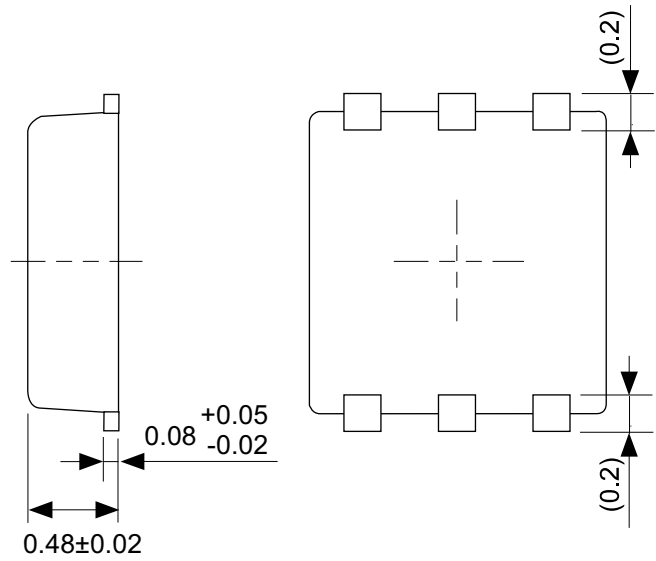
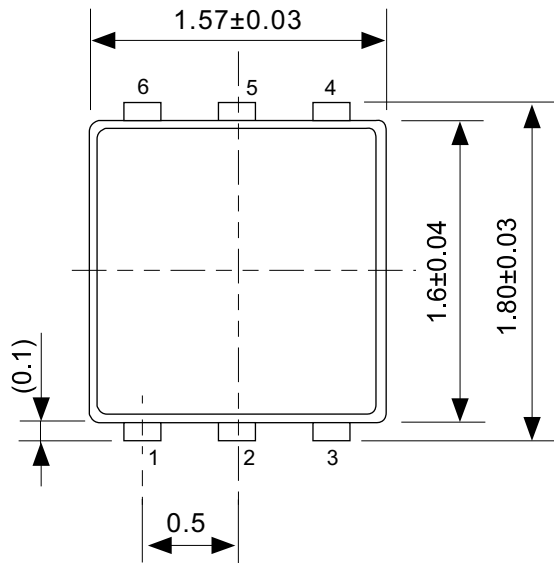

No. PG006-A-P-SD-2.0

TITLE	SNT-6A-A-PKG Dimensions
No.	PG006-A-P-SD-2.0
SCALE	
UNIT	mm
SII Semiconductor Corporation	

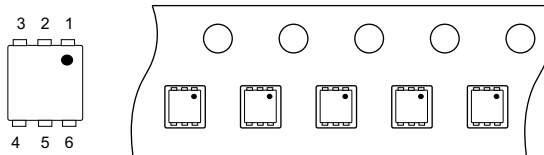
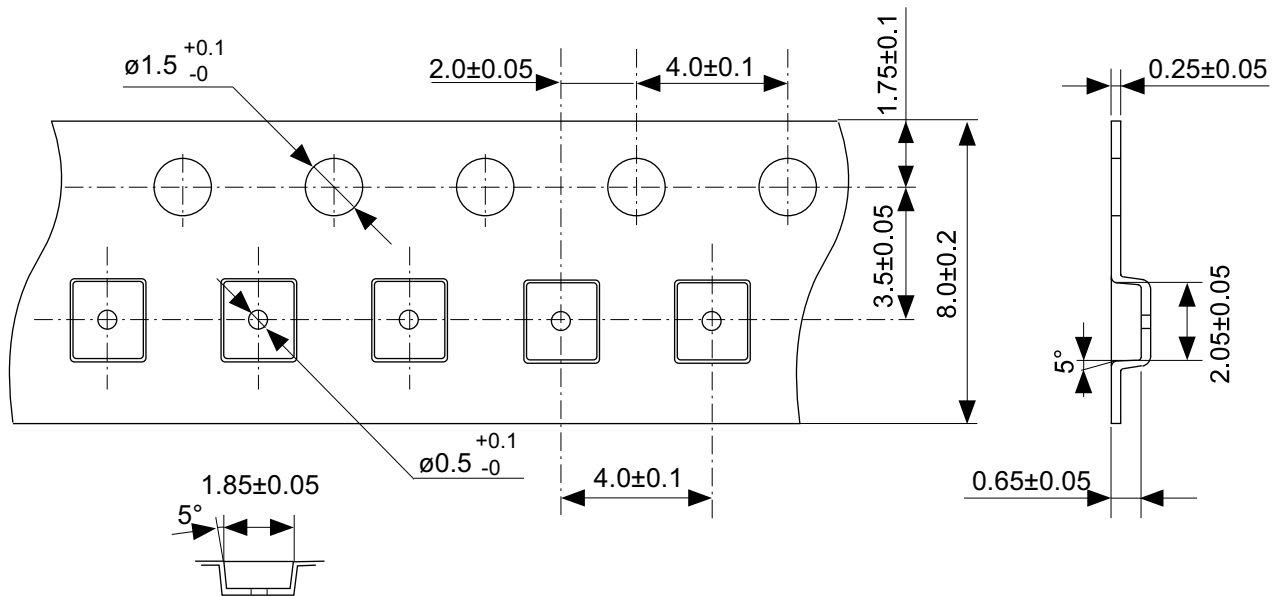

Feed direction →

No. PG006-A-C-SD-1.0

TITLE	SNT-6A-A-Carrier Tape
No.	PG006-A-C-SD-1.0
SCALE	
UNIT	mm
SII Semiconductor Corporation	



Enlarged drawing in the central part



No. PG006-A-R-SD-1.0

TITLE	SNT-6A-A-Reel		
No.	PG006-A-R-SD-1.0		
SCALE		QTY.	5,000
UNIT			
SII Semiconductor Corporation			

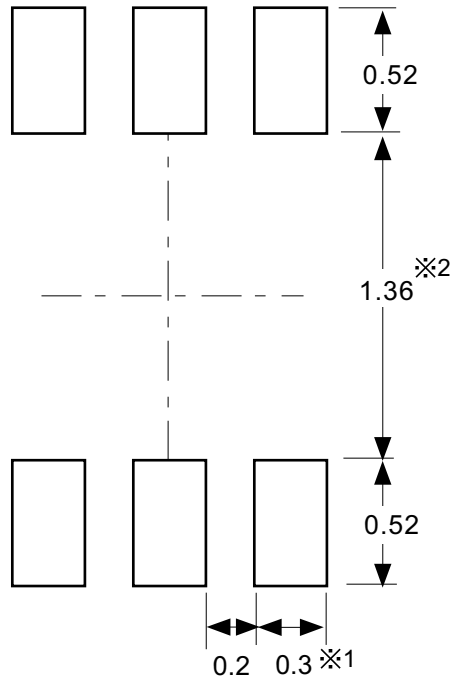

※1. ランドパターンの幅に注意してください (0.25 mm min. / 0.30 mm typ.).
 ※2. パッケージ中央にランドパターンを広げないでください (1.30 mm ~ 1.40 mm)。

- 注意
1. パッケージのモールド樹脂下にシルク印刷やハンダ印刷などしないでください。
 2. パッケージ下の配線上のソルダーレジストなどの厚みをランドパターン表面から0.03 mm 以下にしてください。
 3. マスク開口サイズと開口位置はランドパターンと合わせてください。
 4. 詳細は "SNTパッケージ活用の手引き" を参照してください。

※1. Pay attention to the land pattern width (0.25 mm min. / 0.30 mm typ.).
 ※2. Do not widen the land pattern to the center of the package (1.30 mm ~ 1.40 mm).

- Caution**
1. Do not do silkscreen printing and solder printing under the mold resin of the package.
 2. The thickness of the solder resist on the wire pattern under the package should be 0.03 mm or less from the land pattern surface.
 3. Match the mask aperture size and aperture position with the land pattern.
 4. Refer to "SNT Package User's Guide" for details.

※1. 请注意焊盘模式的宽度 (0.25 mm min. / 0.30 mm typ.).
 ※2. 请勿向封装中间扩展焊盘模式 (1.30 mm ~ 1.40 mm)。

- 注意
1. 请勿在树脂型封装的下面印刷丝网、焊锡。
 2. 在封装下、布线上的阻焊膜厚度 (从焊盘模式表面起) 请控制在 0.03 mm 以下。
 3. 钢网的开口尺寸和开口位置请与焊盘模式对齐。
 4. 详细内容请参阅 "SNT 封装的应用指南"。

No. PG006-A-L-SD-4.1

TITLE	SNT-6A-A -Land Recommendation
No.	PG006-A-L-SD-4.1
SCALE	
UNIT	mm
SII Semiconductor Corporation	

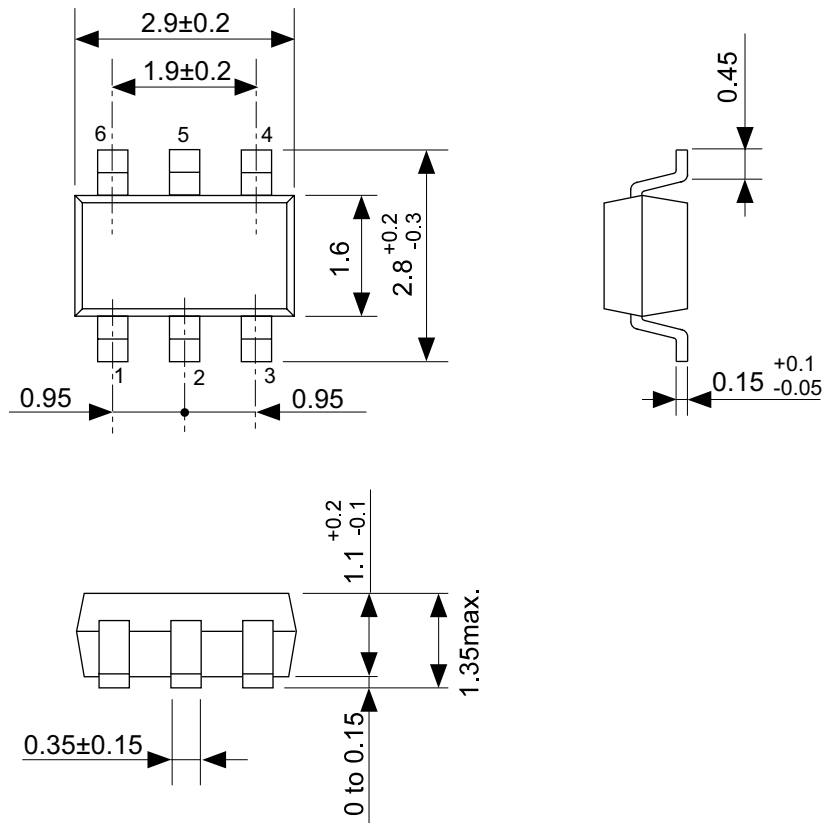

No. MP006-A-P-SD-2.0

TITLE	SOT236-A-PKG Dimensions
No.	MP006-A-P-SD-2.0
SCALE	
UNIT	mm
SII Semiconductor Corporation	

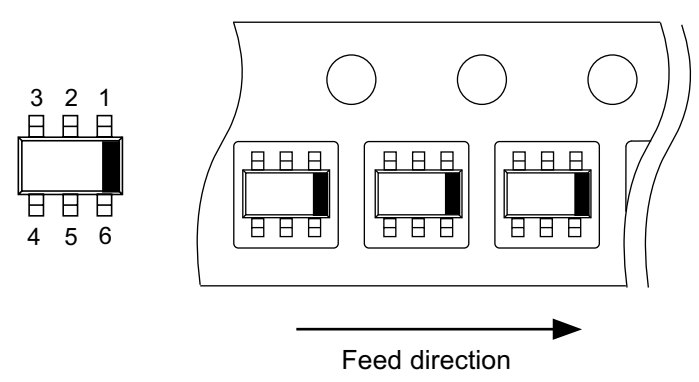
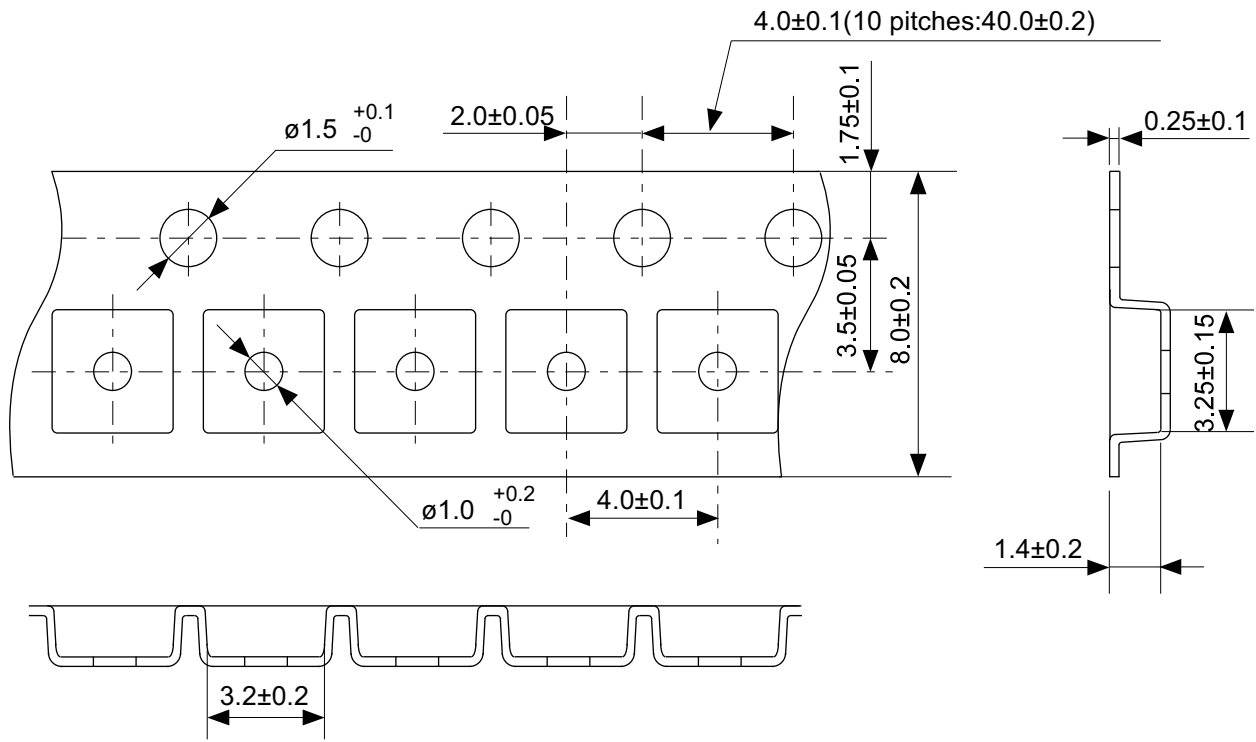

No. MP006-A-C-SD-3.1

TITLE	SOT236-A-Carrier Tape
No.	MP006-A-C-SD-3.1
SCALE	
UNIT	mm
SII Semiconductor Corporation	

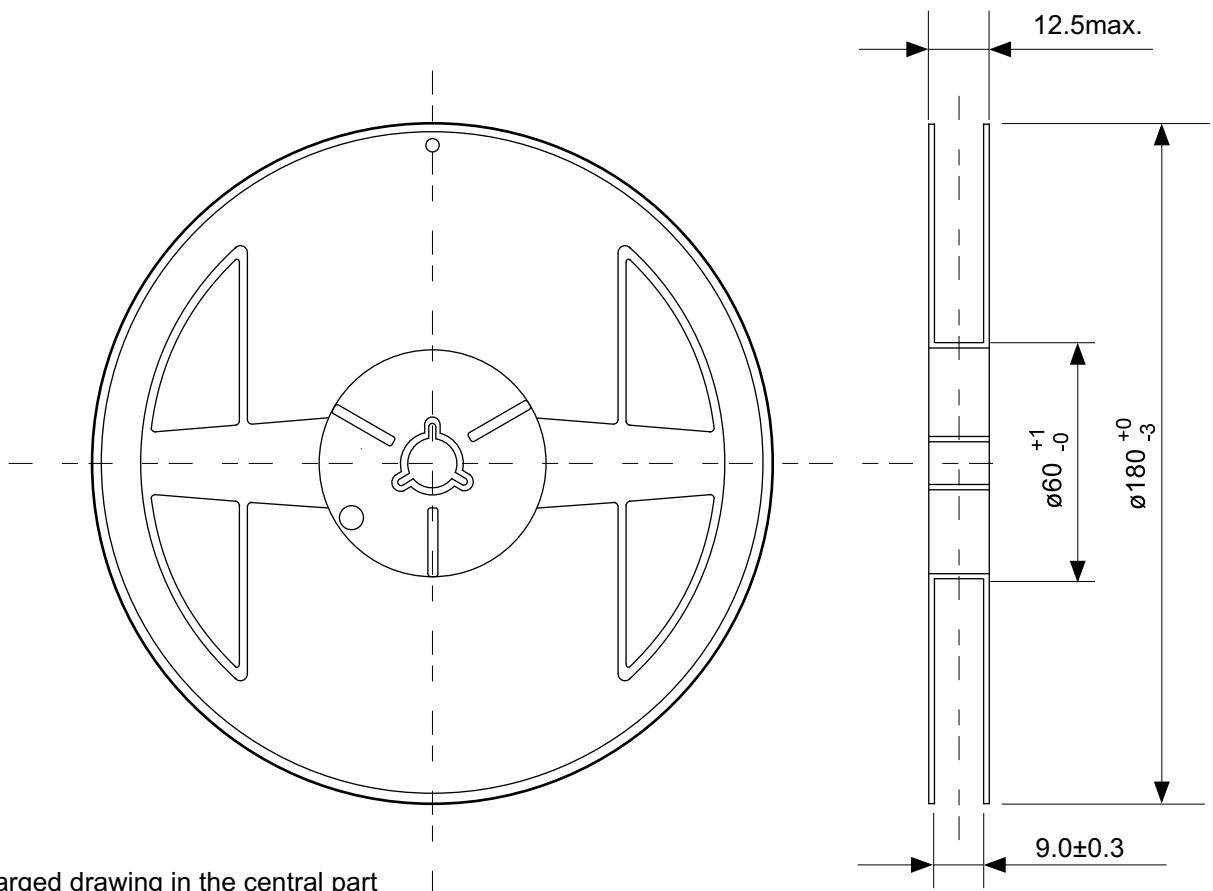

Enlarged drawing in the central part

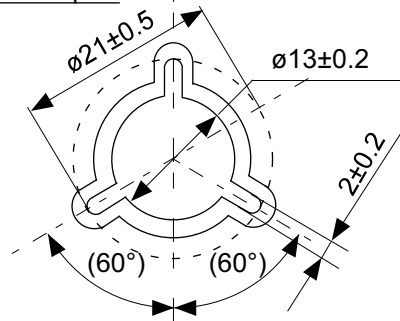

No. MP006-A-R-SD-2.1

TITLE	SOT236-A-Reel		
No.	MP006-A-R-SD-2.1		
SCALE		QTY	3,000
UNIT	mm		
SII Semiconductor Corporation			

Disclaimers (Handling Precautions)

1. All the information described herein (product data, specifications, figures, tables, programs, algorithms and application circuit examples, etc.) is current as of publishing date of this document and is subject to change without notice.
2. The circuit examples and the usages described herein are for reference only, and do not guarantee the success of any specific mass-production design.
SII Semiconductor Corporation is not responsible for damages caused by the reasons other than the products or infringement of third-party intellectual property rights and any other rights due to the use of the information described herein.
3. SII Semiconductor Corporation is not responsible for damages caused by the incorrect information described herein.
4. Take care to use the products described herein within their specified ranges. Pay special attention to the absolute maximum ratings, operation voltage range and electrical characteristics, etc.
SII Semiconductor Corporation is not responsible for damages caused by failures and/or accidents, etc. that occur due to the use of products outside their specified ranges.
5. When using the products described herein, confirm their applications, and the laws and regulations of the region or country where they are used and verify suitability, safety and other factors for the intended use.
6. When exporting the products described herein, comply with the Foreign Exchange and Foreign Trade Act and all other export-related laws, and follow the required procedures.
7. The products described herein must not be used or provided (exported) for the purposes of the development of weapons of mass destruction or military use. SII Semiconductor Corporation is not responsible for any provision (export) to those whose purpose is to develop, manufacture, use or store nuclear, biological or chemical weapons, missiles, or other military use.
8. The products described herein are not designed to be used as part of any device or equipment that may affect the human body, human life, or assets (such as medical equipment, disaster prevention systems, security systems, combustion control systems, infrastructure control systems, vehicle equipment, traffic systems, in-vehicle equipment, aviation equipment, aerospace equipment, and nuclear-related equipment), excluding when specified for in-vehicle use or other uses. Do not use those products without the prior written permission of SII Semiconductor Corporation. Especially, the products described herein cannot be used for life support devices, devices implanted in the human body and devices that directly affect human life, etc.
Prior consultation with our sales office is required when considering the above uses.
SII Semiconductor Corporation is not responsible for damages caused by unauthorized or unspecified use of our products.
9. Semiconductor products may fail or malfunction with some probability.
The user of these products should therefore take responsibility to give thorough consideration to safety design including redundancy, fire spread prevention measures, and malfunction prevention to prevent accidents causing injury or death, fires and social damage, etc. that may ensue from the products' failure or malfunction.
The entire system must be sufficiently evaluated and applied on customer's own responsibility.
10. The products described herein are not designed to be radiation-proof. The necessary radiation measures should be taken in the product design by the customer depending on the intended use.
11. The products described herein do not affect human health under normal use. However, they contain chemical substances and heavy metals and should therefore not be put in the mouth. The fracture surfaces of wafers and chips may be sharp. Take care when handling these with the bare hands to prevent injuries, etc.
12. When disposing of the products described herein, comply with the laws and ordinances of the country or region where they are used.
13. The information described herein contains copyright information and know-how of SII Semiconductor Corporation.
The information described herein does not convey any license under any intellectual property rights or any other rights belonging to SII Semiconductor Corporation or a third party. Reproduction or copying of the information described herein for the purpose of disclosing it to a third-party without the express permission of SII Semiconductor Corporation is strictly prohibited.
14. For more details on the information described herein, contact our sales office.

1.0-2016.01

