

QTLP630C-R Red

QTLP630C-E Orange

QTLP630C-O Yellow-Orange

QTLP630C-Y Yellow

QTLP630C-AG Yellow-Green

QTLP630C-IG True Green

QTLP630C-IB Blue

PACKAGE DIMENSIONS

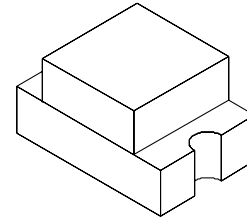
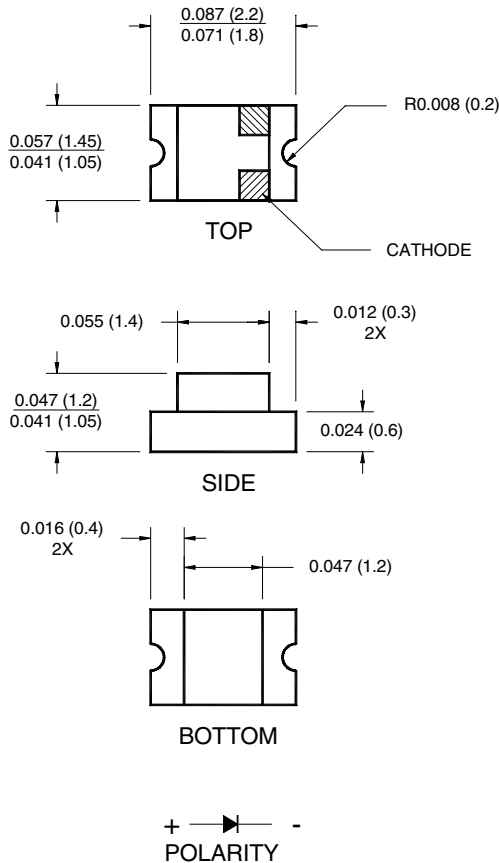

NOTE:

Dimensions for all drawings are in inches (mm).

APPLICATIONS

- Keypad backlighting
- Push-button backlighting
- LCD backlighting

DESCRIPTION

These surface mount chip LEDs are designed to fit industry standard footprint. Low profile and wide viewing angle make these LEDs ideal choices for backlighting applications and panel illumination.

FEATURES

- Small footprint - 2.0(L) X 1.25(W) X 1.1(H) mm
- AllInGaP technology for -R, -E, -O, -Y and -AG
- InGaN/SiC technology for -IG and -IB
- Wide viewing angle of 140°
- Water clear optics
- Moisture-proof packaging
- Available in 0.315" (8mm) width tape on 7" (178mm) diameter reel; 2,000 units per reel

QTLP630C-R Red

QTLP630C-E Orange

QTLP630C-O Yellow-Orange

QTLP630C-Y Yellow

QTLP630C-AG Yellow-Green

QTLP630C-IG True Green

QTLP630C-IB Blue

ABSOLUTE MAXIMUM RATINGS (T_A =25°C Unless otherwise specified)

| Parameter | Symbol | QTLP630C | | | | | Units |
|---|------------------|---------------|-----|-----|-----|-----|-------|
| | | -R | -E | -O | -Y | -AG | |
| Continuous Forward Current | I _F | 30 | 30 | 30 | 25 | 30 | mA |
| Peak Forward Current (f = 1.0 KHz, Duty Factor = 1/10) | I _{FM} | 160 | 160 | 160 | 120 | 160 | mA |
| Reverse Voltage | V _R | 5 | 5 | 5 | 5 | 5 | V |
| Power Dissipation | P _D | 72 | 72 | 72 | 60 | 72 | mW |
| Operating Temperature | T _{OPR} | -40 to +85 | | | | | °C |
| Storage Temperature | T _{STG} | -40 to +90 | | | | | °C |
| Lead Soldering Time | T _{SOL} | 260 for 5 sec | | | | | °C |

ABSOLUTE MAXIMUM RATINGS (T_A =25°C Unless otherwise specified)

| Parameter | Symbol | QTLP630C | | Units |
|---|------------------|---------------|-----|-------|
| | | -IB | -IG | |
| Continuous Forward Current | I _F | 30 | 30 | mA |
| Peak Forward Current (f = 1.0 KHz, Duty Factor = 1/10) | I _{FM} | 100 | 100 | mA |
| Reverse Voltage | V _R | 5 | 5 | V |
| Power Dissipation | P _D | 120 | 120 | mW |
| Operating Temperature | T _{OPR} | -40 to +85 | | °C |
| Storage Temperature | T _{STG} | -40 to +90 | | °C |
| Lead Soldering Time | T _{SOL} | 260 for 5 sec | | °C |

QTLP630C-R Red

QTLP630C-E Orange

QTLP630C-O Yellow-Orange

QTLP630C-Y Yellow

QTLP630C-AG Yellow-Green

QTLP630C-IG True Green

QTLP630C-IB Blue

ELECTRICAL / OPTICAL CHARACTERISTICS (T_A =25°C)

| Part Number | Symbol | QTLP630C | | | | | Condition |
|-------------------------------|-------------------|----------|-----|-----|-----|-----|-----------------------|
| | | -R | -E | -O | -Y | -AG | |
| Luminous Intensity (mcd) | I _v | 15 | 15 | 15 | 15 | 10 | I _F = 20mA |
| Minimum | | 40 | 40 | 40 | 40 | 15 | |
| Typical | | | | | | | |
| Forward Voltage (V) | V _F | 2.4 | 2.4 | 2.4 | 2.4 | 2.4 | I _F = 20mA |
| Maximum | | 2.0 | 2.0 | 2.0 | 2.0 | 2.0 | |
| Typical | | | | | | | |
| Wavelength (nm) | λ _P | 630 | 620 | 610 | 590 | 575 | I _F = 20mA |
| Peak | | 624 | 615 | 605 | 589 | 573 | |
| Dominant | λ _D | | | | | | |
| Spectral Line Half Width (nm) | Δλ | 20 | 18 | 18 | 15 | 20 | I _F = 20mA |
| Viewing Angle (°) | 2Θ _{1/2} | 140 | 140 | 140 | 140 | 140 | I _F = 20mA |

ELECTRICAL / OPTICAL CHARACTERISTICS (T_A =25°C)

| Part Number | Symbol | QTLP630C | | Condition |
|-------------------------------|-------------------|----------|-----|-----------------------|
| | | -IB | -IG | |
| Luminous Intensity (mcd) | I _v | 20 | 75 | I _F = 20mA |
| Minimum | | 25 | 120 | |
| Typical | | | | |
| Forward Voltage (V) | V _F | 4.0 | 4.0 | I _F = 20mA |
| Maximum | | 3.5 | 3.5 | |
| Typical | | | | |
| Wavelength (nm) | λ _P | 465 | 520 | I _F = 20mA |
| Peak | | 470 | 525 | |
| Dominant | λ _D | | | |
| Spectral Line Half Width (nm) | Δλ | 25 | 35 | I _F = 20mA |
| Viewing Angle (°) | 2Θ _{1/2} | 140 | 140 | I _F = 20mA |

QTLP630C-R Red

QTLP630C-E Orange

QTLP630C-O Yellow-Orange

QTLP630C-Y Yellow

QTLP630C-AG Yellow-Green

QTLP630C-IG True Green

QTLP630C-IB Blue

TYPICAL PERFORMANCE CURVES (QTLP630C-R, -E, -O, -Y and -AG)

Fig. 1 Forward Current vs. Forward Voltage

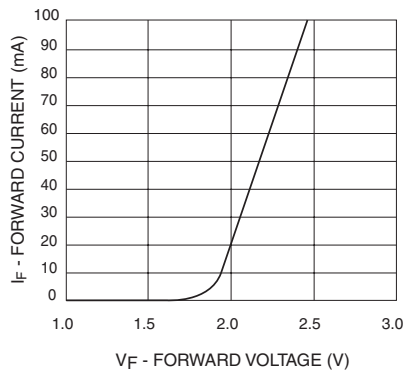

Fig. 2 Relative Luminous Intensity vs. DC Forward Current

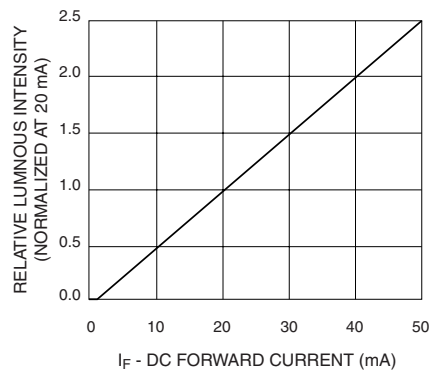

Fig. 3 Relative Intensity vs. Peak Wavelength

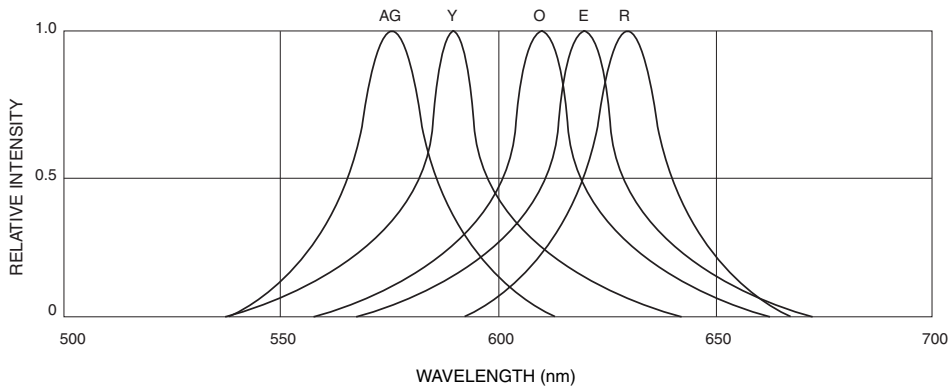

Fig.4 Radiation Diagram

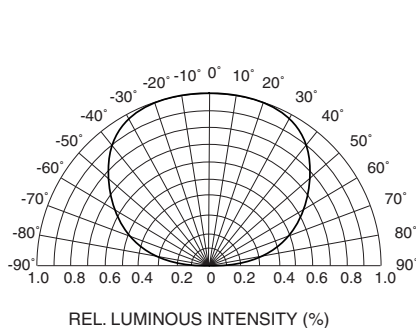
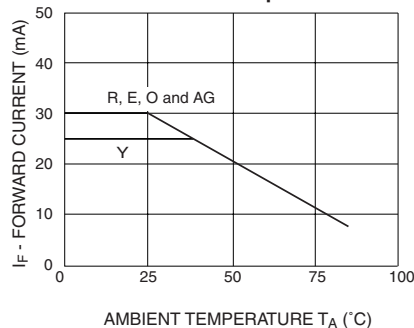

Fig.5 Maximum Forward Current vs. Ambient Temperature



QTLP630C-R Red

QTLP630C-E Orange

QTLP630C-O Yellow-Orange

QTLP630C-Y Yellow

QTLP630C-AG Yellow-Green

QTLP630C-IG True Green

QTLP630C-IB Blue

TYPICAL PERFORMANCE CURVES (QTLP630C-IG and IB)

Fig. 1 Forward Current vs. Forward Voltage

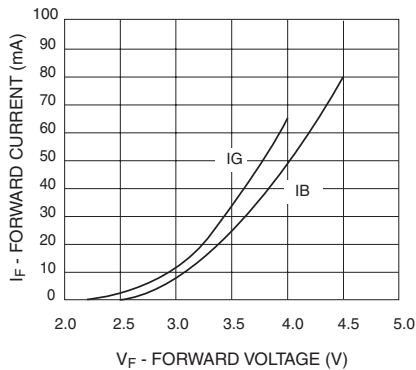

Fig. 2 Relative Luminous Intensity vs. DC Forward Current

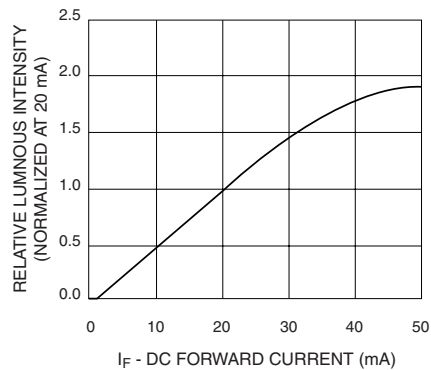

Fig. 3 Relative Intensity vs. Peak Wavelength

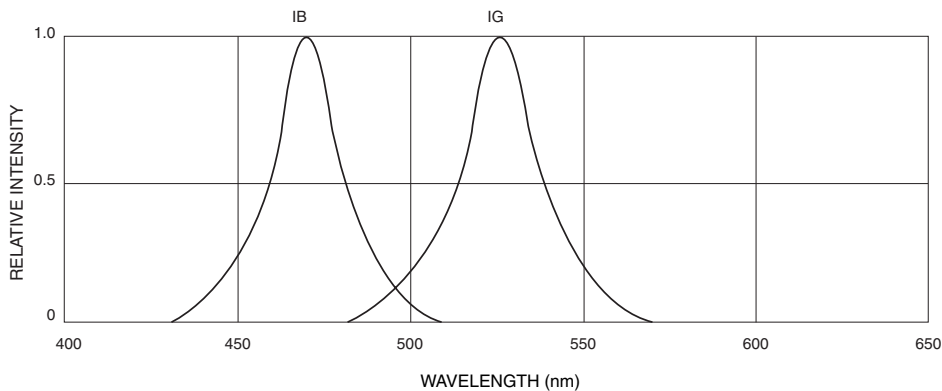

Fig.4 Radiation Diagram

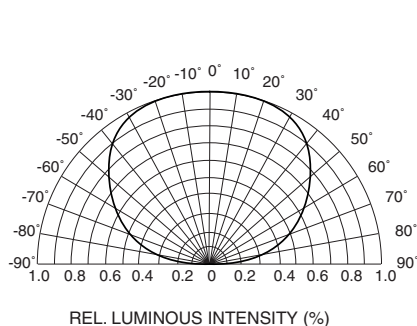
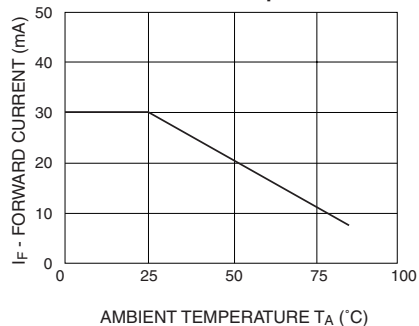

Fig.5 Maximum Forward Current vs. Ambient Temperature



QTLP630C-R Red

QTLP630C-E Orange

QTLP630C-O Yellow-Orange

QTLP630C-Y Yellow

QTLP630C-AG Yellow-Green

QTLP630C-IG True Green

QTLP630C-IB Blue

RECOMMENDED PRINTED CIRCUIT BOARD PATTERN

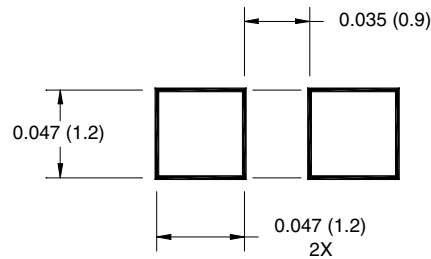

RECOMMENDED IR REFLOW SOLDERING PROFILE

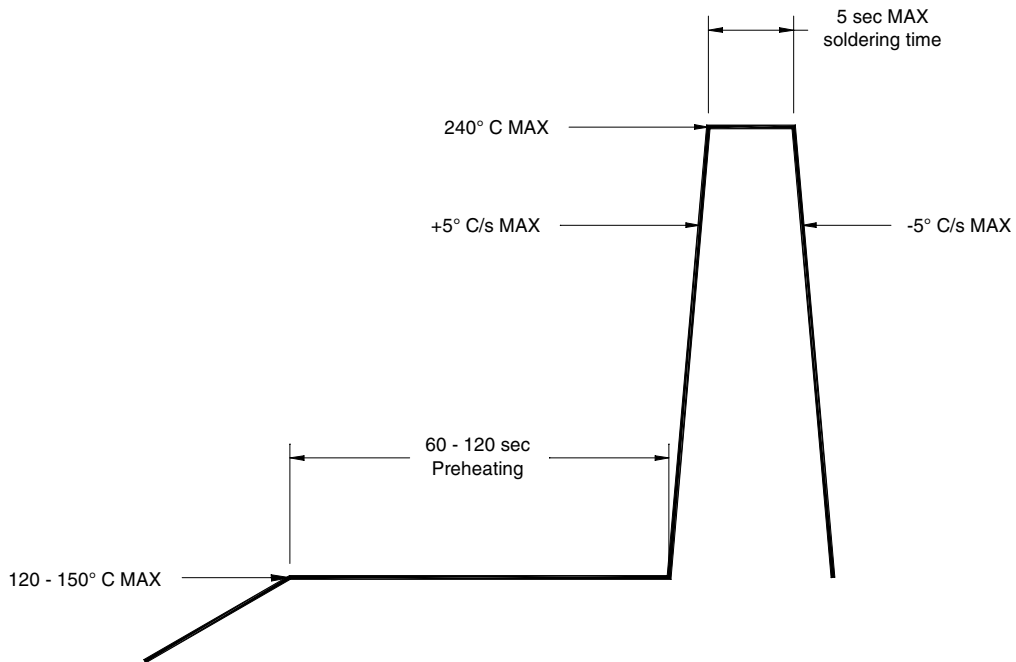

QTLP630C-R Red

QTLP630C-E Orange

QTLP630C-O Yellow-Orange

QTLP630C-Y Yellow

QTLP630C-AG Yellow-Green

QTLP630C-IG True Green

QTLP630C-IB Blue

TAPE AND REEL DIMENSIONS

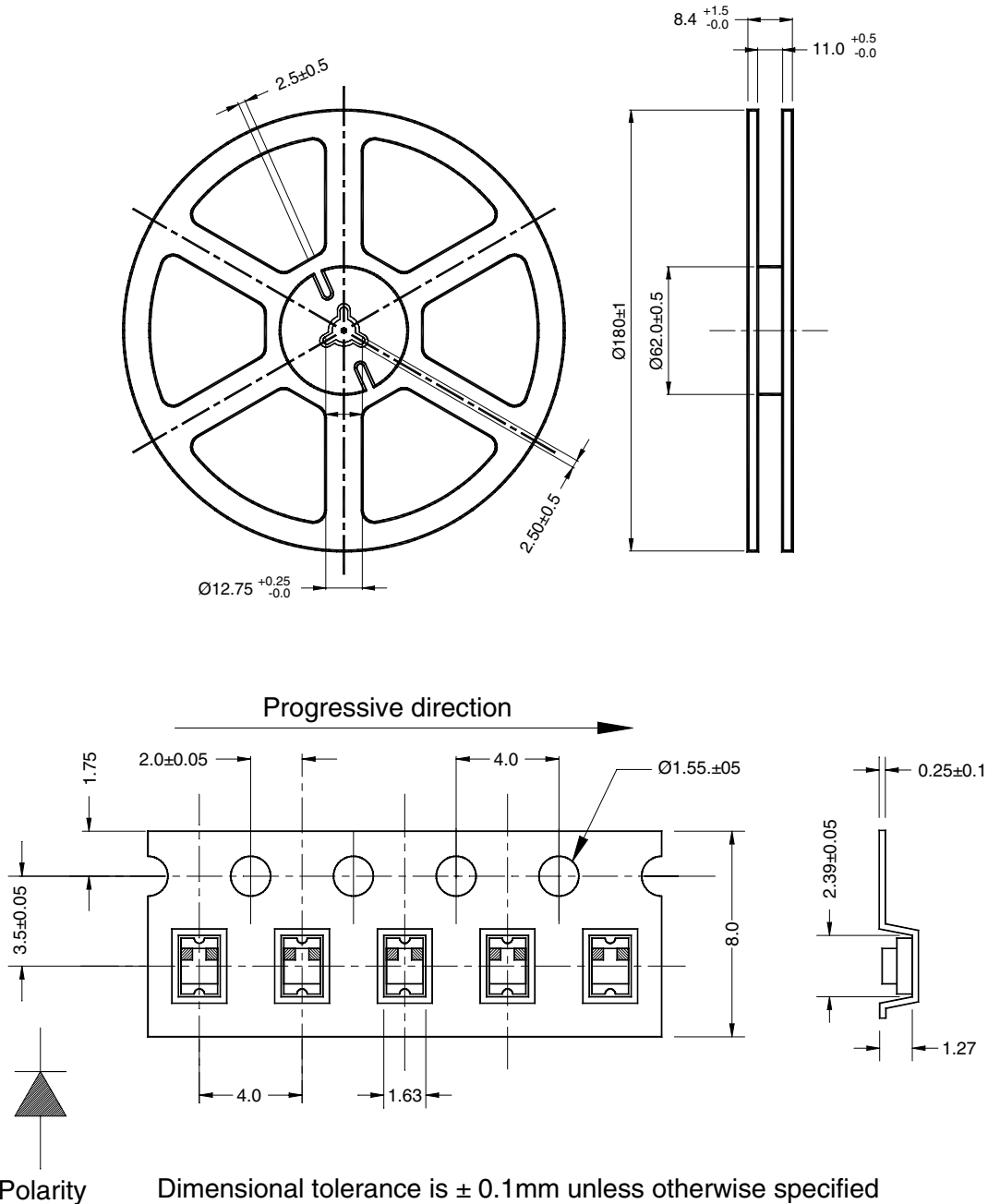

Dimensional tolerance is ± 0.1 mm unless otherwise specified

Angle: ± 0.5

Unit: mm

QTLP630C-R Red

QTLP630C-E Orange

QTLP630C-O Yellow-Orange

QTLP630C-Y Yellow

QTLP630C-AG Yellow-Green

QTLP630C-IG True Green

QTLP630C-IB Blue

DISCLAIMER

FAIRCHILD SEMICONDUCTOR RESERVES THE RIGHT TO MAKE CHANGES WITHOUT FURTHER NOTICE TO ANY PRODUCTS HEREIN TO IMPROVE RELIABILITY, FUNCTION OR DESIGN. FAIRCHILD DOES NOT ASSUME ANY LIABILITY ARISING OUT OF THE APPLICATION OR USE OF ANY PRODUCT OR CIRCUIT DESCRIBED HEREIN; NEITHER DOES IT CONVEY ANY LICENSE UNDER ITS PATENT RIGHTS, NOR THE RIGHTS OF OTHERS.

LIFE SUPPORT POLICY

FAIRCHILD'S PRODUCTS ARE NOT AUTHORIZED FOR USE AS CRITICAL COMPONENTS IN LIFE SUPPORT DEVICES OR SYSTEMS WITHOUT THE EXPRESS WRITTEN APPROVAL OF THE PRESIDENT OF FAIRCHILD SEMICONDUCTOR CORPORATION. As used herein:

1. Life support devices or systems are devices or systems which, (a) are intended for surgical implant into the body, or (b) support or sustain life, and (c) whose failure to perform when properly used in accordance with instructions for use provided in labeling, can be reasonably expected to result in a significant injury of the user.
2. A critical component in any component of a life support device or system whose failure to perform can be reasonably expected to cause the failure of the life support device or system, or to affect its safety or effectiveness.