

**DESIGNED & DIMENSIONED
IN MILLIMETERS [INCHES]**

DO NOT
SCALE FROM
THIS PRINT

TABLE 1			
ITEM	COMPONENT	-H	-HN
1	SUB ASSEMBLY	SUB-MMCX-P-C-F-ST-CA2	SUB-MMCX-P-C-FN-ST-CA2
2	PIN	MMCX-PIN-002-H	
3	OUTER FERRULE	MCX-FER-005-F	MCX-FER-005-N

MMCX-P-C-XX-ST-CA2

GENDER
-P: PLUG

TERMINATION
-CA2: (RG 178 CABLE)

TYPE
-C: CABLE

ORIENTATION
-ST: STRAIGHT

PLATING SPECIFICATION

-H: 30µ" GOLD CENTER CONTACT,
3µ" GOLD OUTER CONTACT
-HN: 30µ" GOLD CENTER CONTACT,
100µ" NICKEL OUTER CONTACT
(SEE TABLE 1)

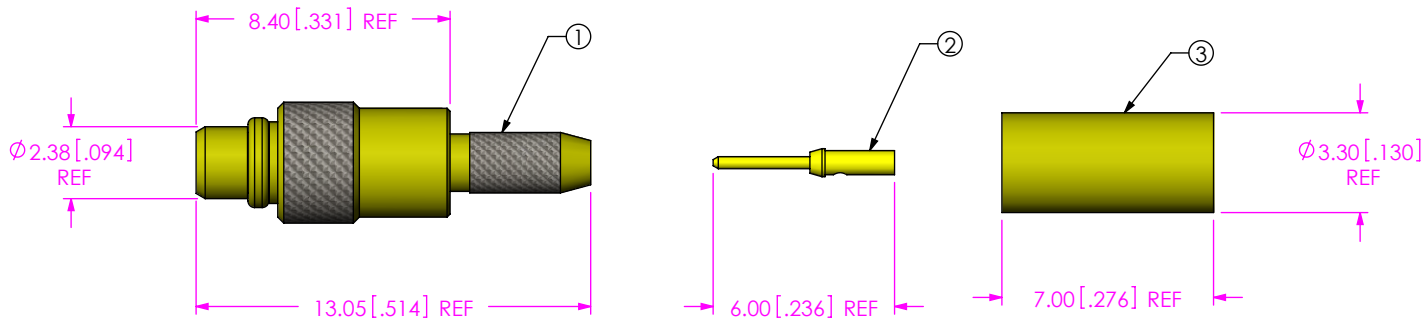

NOTES:

- 1. NOTE DELETED.
- 2. NOTE DELETED.
- 3. NOTE DELETED.
- 4. NOTE DELETED.
- 5. PRODUCT TO BE PACKAGED PER PACKAGING STANDARD CO-RF-WI-3040-M.
- 6. NOTE DELETED.
- 7. NOTE DELETED.
- 8. NOTE DELETED.

F:\DWG\MISC\MKTG\MMCX-P-C-XX-ST-CA2-MKT.SLDDRW

<p>UNLESS OTHERWISE SPECIFIED, DIMENSIONS ARE IN MILLIMETERS [INCHES]. TOLERANCES ARE:</p> <p>DECIMALS ANGLES</p> <p>.X: ±0.3 [0.1] 5°</p> <p>.XX: ±0.13 [0.05]</p> <p>.XXX: ±0.051 [0.020]</p>	<p>PROPRIETARY NOTE</p> <p>THIS DOCUMENT CONTAINS CONFIDENTIAL AND PROPRIETARY INFORMATION AND ALL DESIGN, MANUFACTURING, REPRODUCTION, USE, PATENT RIGHTS AND SALES RIGHTS ARE EXPRESSLY RESERVED BY SAMTEC, INC. THIS DOCUMENT SHALL NOT BE DISCLOSED, IN WHOLE OR PART, TO ANY UNAUTHORIZED PERSON OR ENTITY NOR REPRODUCED, TRANSFERRED OR INCORPORATED IN ANY OTHER PROJECT IN ANY MANNER WITHOUT THE EXPRESS WRITTEN CONSENT OF SAMTEC, INC.</p>	 <p>520 PARK EAST BLVD, NEW ALBANY, IN 47150 PHONE: 812-944-6733 FAX: 812-948-5047 e-Mail: info@SAMTEC.com code: 55322</p>

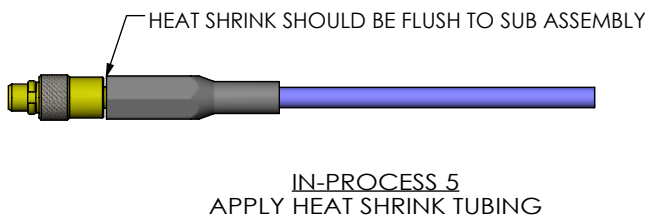
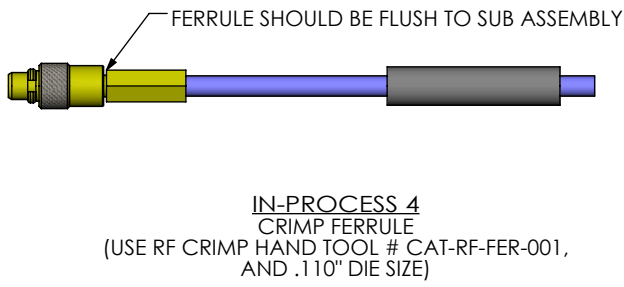
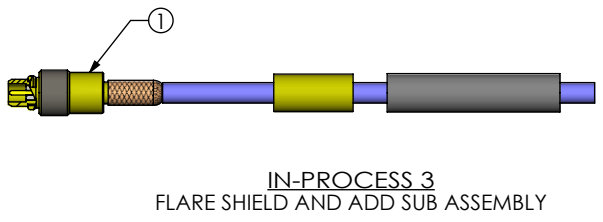
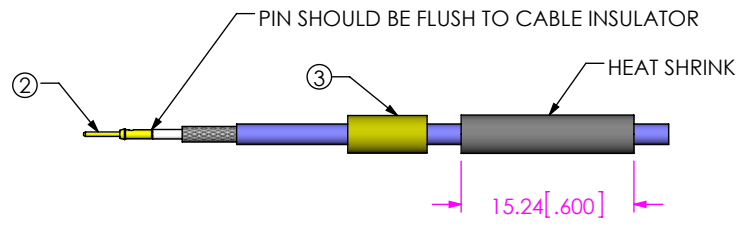
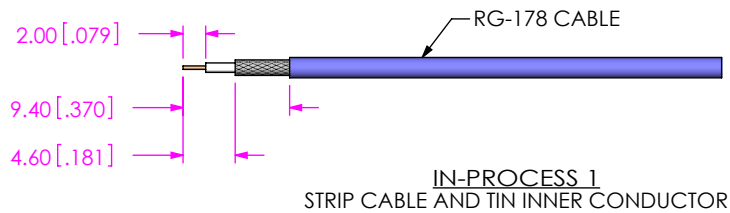

PROPRIETARY NOTE
THIS DOCUMENT CONTAINS CONFIDENTIAL AND PROPRIETARY INFORMATION AND ALL DESIGN, MANUFACTURING, REPRODUCTION, USE, PATENT RIGHTS AND SALES RIGHTS ARE EXPRESSLY RESERVED BY SAMTEC, INC. THIS DOCUMENT SHALL NOT BE DISCLOSED, IN WHOLE OR PART, TO ANY UNAUTHORIZED PERSON OR ENTITY NOR REPRODUCED, TRANSFERRED OR INCORPORATED IN ANY OTHER PROJECT IN ANY MANNER WITHOUT THE EXPRESS WRITTEN CONSENT OF SAMTEC, INC.

DO NOT SCALE DRAWING
SHEET SCALE: 1:0.666667



520 PARK EAST BLVD, NEW ALBANY, IN 47150
PHONE: 812-944-6733 FAX: 812-948-5047
e-Mail: info@SAMTEC.com code: 55322

DESCRIPTION:
MMCX STR CABLE PLUG, RG178- 50 OHM

DWG. NO.
MMCX-P-C-XX-ST-CA2

BY: R MUSSER 02/06/2008 SHEET 2 OF 2