

## Flush-type connector - SACC-DSI-M12FS-4CON-M16 - 1419755

Please be informed that the data shown in this PDF Document is generated from our Online Catalog. Please find the complete data in the user's documentation. Our General Terms of Use for Downloads are valid (<http://download.phoenixcontact.com>)



Sensor/actuator flush-type socket, 4-pos., M12 SPEEDCON, A-coded, rear/screw mounting with M16 thread, with straight solder connection



### Key commercial data

Packing unit	1 1
Minimum order quantity	20 1
Weight per Piece (excluding packing)	14.0 GRM
Custom tariff number	85366990
Country of origin	Germany

### Technical data

#### Dimensions

Length of the solder pin	6 mm
--------------------------	------

#### Ambient conditions

Ambient temperature (operation)	-25 °C ... 85 °C (Plug / socket)
Degree of protection	IP67

#### General

Rated current at 40°C	4 A
Rated voltage	250 V
Number of positions	4
Contact resistance	≤ 3 mΩ
Insulation resistance	≥ 100 MΩ
Coding	A - standard
Standards/regulations	M12 connector IEC 61076-2-101
Status display	No

# Flush-type connector - SACC-DSI-M12FS-4CON-M16 - 1419755

## Technical data

### General

Surge voltage category	II
Pollution degree	3
Connection method	Solder pins
Mounting type	Rear mounting M16 x 1.5 With flat nut

### Material

Inflammability class according to UL 94	V0
Contact material	CuZn
Contact surface material	Au
Contact carrier material	PA 66
Material, knurls	Zinc die-cast, nickel-plated
Sealing material	NBR

## Classifications

### eCl@ss

eCl@ss 4.0	27140815
eCl@ss 4.1	27140815
eCl@ss 5.0	27143423
eCl@ss 5.1	27143423
eCl@ss 6.0	27279220
eCl@ss 7.0	27440103
eCl@ss 8.0	27440103

### ETIM

ETIM 2.0	EC001297
ETIM 3.0	EC002061
ETIM 4.0	EC002061
ETIM 5.0	EC002061

### UNSPSC

UNSPSC 6.01	31251501
UNSPSC 7.0901	31251501
UNSPSC 11	31251501
UNSPSC 12.01	31251501
UNSPSC 13.2	39121413

# Flush-type connector - SACC-DSI-M12FS-4CON-M16 - 1419755

## Approvals

Approvals

---

Approvals

UL Recognized / GOST / GOST

---

Ex Approvals

---

Approvals submitted

---

## Approval details

UL Recognized 	
mm <sup>2</sup> /AWG/kcmil	26-20
Nominal current I <sub>N</sub>	4 A
Nominal voltage U <sub>N</sub>	250 V

GOST 
--

GOST 
--

## Drawings

# Flush-type connector - SACC-DSI-M12FS-4CON-M16 - 1419755

Dimensioned drawing

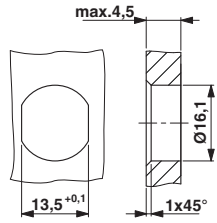

Schematic diagram

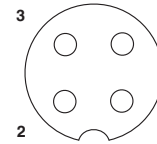

Pin assignment M12 socket, 4-pos., A-coded, view female side

Housing cutout for M16 fastening thread, mounting panel with feed-through hole (alternatively with surface as protection against rotation)

Drilling diagram

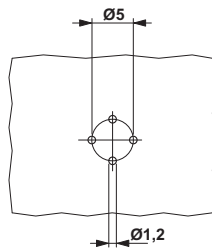

Dimensioned drawing

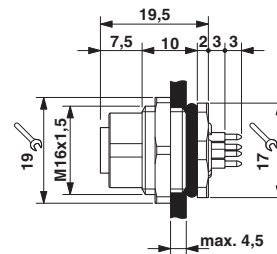

Dimensioned drawing

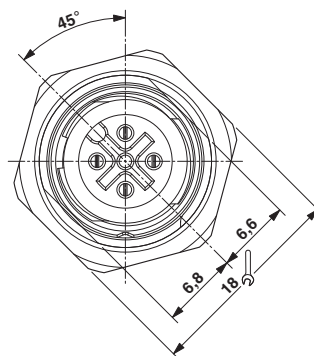

M12 front view