

MASSE OHNE TOLERANZ SIND KEINE PRUEFMASSE  
 DIMS. WITHOUT TOLERANCE ARE NOT CONTROL DIMS.

WEITERGABE SOWIE VERVIELFÄLTIGUNG DIESER DOKUMENTS, VERWERTUNG UND MITTEILUNG SEINER INHALTS SIND VERBOTEN, SOWEIT NICHT AUSDRUECKLICH GESTATET.  
 ZUWIDERHANDLUNGEN VERPFLICHTEN ZU SCHADENSERSATZ. ALLE RECHTE FUER DEN FALL DER PATENT-, GEBRAUCHSMUSTER- ODER GESCHMACKSMUSTEREINTRAGUNG VORBEHALTEN.  
 THE REPRODUCTION, DISTRIBUTION AND UTILIZATION OF THIS DOCUMENT AS WELL AS THE COMMUNICATION OF ITS CONTENTS TO OTHERS WITHOUT EXPLICIT AUTHORIZATION IS PROHIBITED.  
 OFFENDERS WILL BE HELD LIABLE FOR THE PAYMENT OF DAMAGES. ALL RIGHTS RESERVED IN THE EVENT OF THE GRANT OF A PATENT, UTILITY MODEL OR DESIGN.

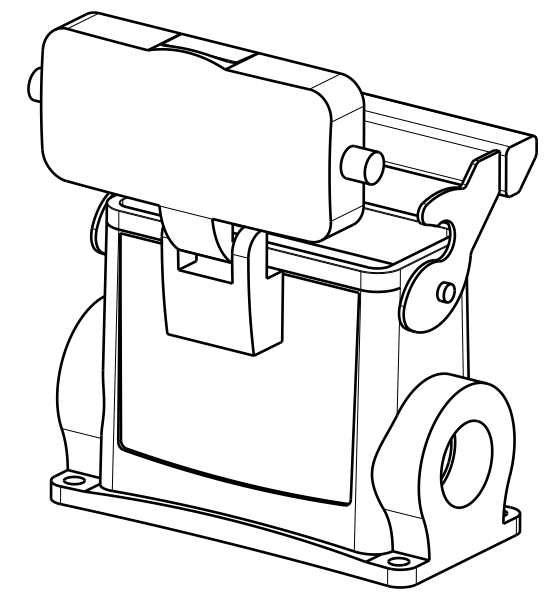
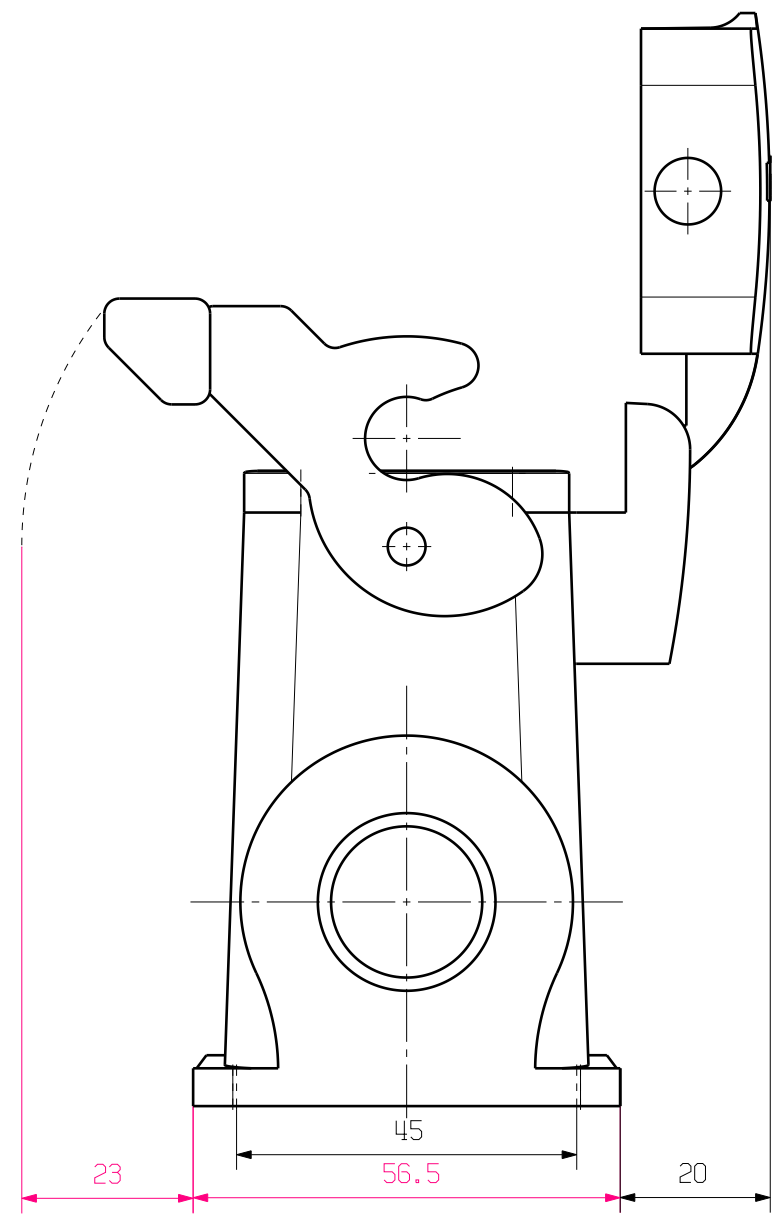
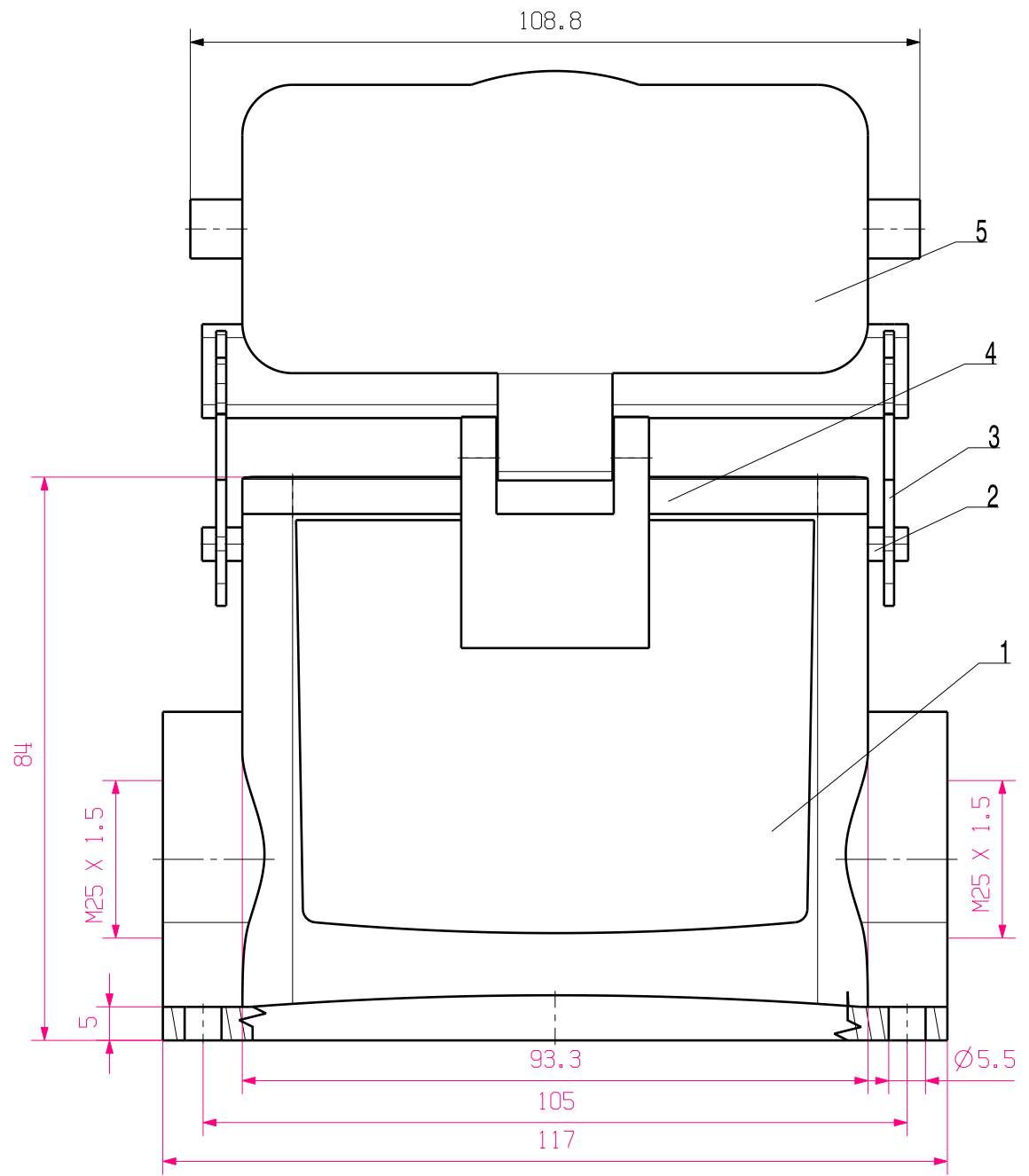

5	COVER	ALUMINIUM WITH POWDER COATING
4	SEALING	NBR
3	LOCKING	STAINLESS STEEL
2	LOCKING BOLTS	STAINLESS STEEL
1	BASE HOUSING	ALUMINIUM WITH POWDER COATING
ROHSTOFF-NR. R.PART NO.	TYP PART NAME	WERKSTOFF MATERIAL

MAX. NRN./NOS. ?		CAT.NO.: 1787180000	
Weidmüller		DRAWING NO.	ISSUE NO.
MODIFICATION		HDC 40D SDLU 2M25G SOCKELGEHAEUSE BASE HOUSING	
SCALE: 1/1	DRAWN	DATE	NAME
SUPERSEDES:	RESPONSIBLE	27.10.2005	YANG_A
SUPERSEDED BY:	CHECKED	31.10.2005	ZHANG_T
	APPROVED		
PRODUCT FILE:			