

# MODEL PAXDR - 1/8 DIN DUAL RATE METER / TOTALIZER



- SIX DISPLAYS - ONE EACH FOR: RATE A & B; TOTALIZER A & B; DISPLAY C RATE CALCULATION & TOTALIZER CALCULATION
- DISPLAY C CALCULATIONS: SUM (A+B), DIFFERENCE (A-B), RATIO (A/B), % OF TOTAL (A/A+B) OR DRAW (A-B/B)
- 0.56" RED SUNLIGHT READABLE DISPLAY
- VARIABLE INTENSITY DISPLAY
- 10 POINT NON-LINEAR SCALING FOR BOTH RATE DISPLAYS
- SEPARATE INPUT SCALING FOR A AND B TOTALIZERS
- PROGRAMMABLE FUNCTION KEYS/USER INPUTS
- FOUR SETPOINT ALARM OUTPUTS (W/Option Card)
- RETRANSMITTED ANALOG OUTPUT (W/Option Card)
- COMMUNICATION AND BUS CAPABILITIES (W/Option Card)
- NEMA 4X/IP65 SEALED FRONT BEZEL

## GENERAL DESCRIPTION

The PAXDR is a 5-digit Dual Rate Indicator and 6-digit Dual Totalizer in a single meter. Two Rate and two Total displays are provided (A and B), along with two additional calculation displays (C) to show the Sum, Difference, Ratio, % of Total or Draw between A and B displays. Any of the six displays are viewable: A, B or C Rate and A, B or C Total. The meter's LED display has 0.56" digits, available in red sunlight readable or standard green. The display intensity is adjustable for low level lighting conditions up to sunlight readable applications.

The meter has two signal inputs from which the Rate and Totalizer values are derived. For the Rate displays, up to 10 point scaling is provided for each input, to scale non-linear rate processes. Separate scaling is provided for both the A and B Totalizers. The independent scaling allows for Rate only, Totalizer only or combination Rate/Totalizer applications, with or without the calculation displays.

While suitable for many applications, this meter is ideal for flow measurement where both flow rate and flow volume are measured. Two separate flow lines can be monitored simultaneously, each scaled to convert flow to a common unit of measure. Flow rate is easily scaled to read flow per time period (sec/min/hr). The flow rate and volume for each line can be shown, as well as the Sum, Difference, Ratio, etc. between the two lines for flow rate and/or volume. A different calculation function may be used for Rate and Total if desired.

Optional plug-in cards provide up to four setpoint outputs, a linear DC output and communications capability. The Plug-in setpoint cards provide dual FORM-C relays (5 A), quad FORM-A relays (3 A), or either quad sinking or quad sourcing open collector logic outputs. The outputs can be assigned to any of the Rate or Totalizer display values, and configured to suit a variety of control and alarm requirements.

The linear DC output Plug-in card provides either 20 mA or 10 V signals. The output can be scaled independent of the input range and can track any of the Rate or Totalizer displays.

Communication and Bus Capabilities are also available as option cards. These include RS232, RS485, Modbus, DeviceNet and Profibus-DP. Readout values and setpoint alarm values can be controlled through the bus. Additionally, the meter has a feature that allows a remote serial device to directly control the meter outputs.

The PAXDR is available in AC or DC powered versions. The meter has been specifically designed for harsh industrial environments. With NEMA 4X/IP65 sealed bezel and extensive testing to meet CE requirements, the meter provides a tough yet reliable application solution.

## SAFETY SUMMARY

All safety related regulations, local codes and instructions that appear in this literature or on equipment must be observed to ensure personal safety and to prevent damage to either the instrument or equipment connected to it. If equipment is used in a manner not specified by the manufacturer, the protection provided by the equipment may be impaired.

Do not use this meter to directly command motors, valves, or other actuators not equipped with safeguards. To do so can be potentially harmful to persons or equipment in the event of a fault to the meter.



**CAUTION: Risk of Danger.**  
 Read complete instructions prior to installation and operation of the unit.



**CAUTION: Risk of electric shock.**

## DIMENSIONS In inches (mm)

Note: Recommended minimum clearance (behind the panel) for mounting clip installation is 2.1" (53.4) H x 5" (127) W.

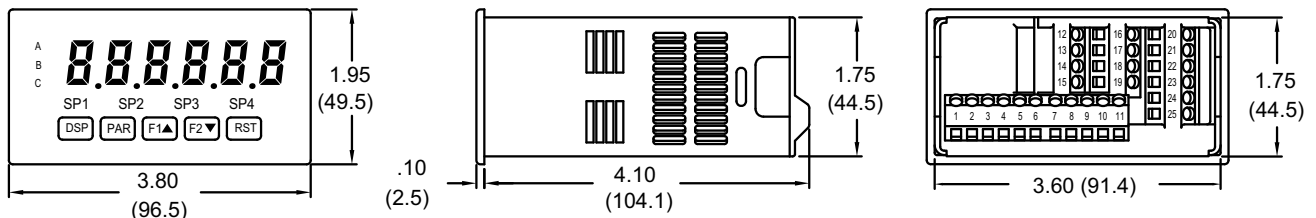

# TABLE OF CONTENTS

Ordering Information . . . . .	2	Reviewing the Front Buttons and Display . . . .	8
Meter Specifications . . . . .	3	Programming the Meter. . . . .	9
Optional Plug-In Output Cards . . . . .	4	Factory Service Operations. . . . .	26
Installing the Meter . . . . .	5	Troubleshooting. . . . .	26
Setting the Jumper and DIP Switches . . . . .	5	Parameter Value Chart . . . . .	27
Installing Plug-In Cards. . . . .	6	Programming Overview. . . . .	31
Wiring the Meter . . . . .	7		

# ORDERING INFORMATION

## Meter Part Numbers

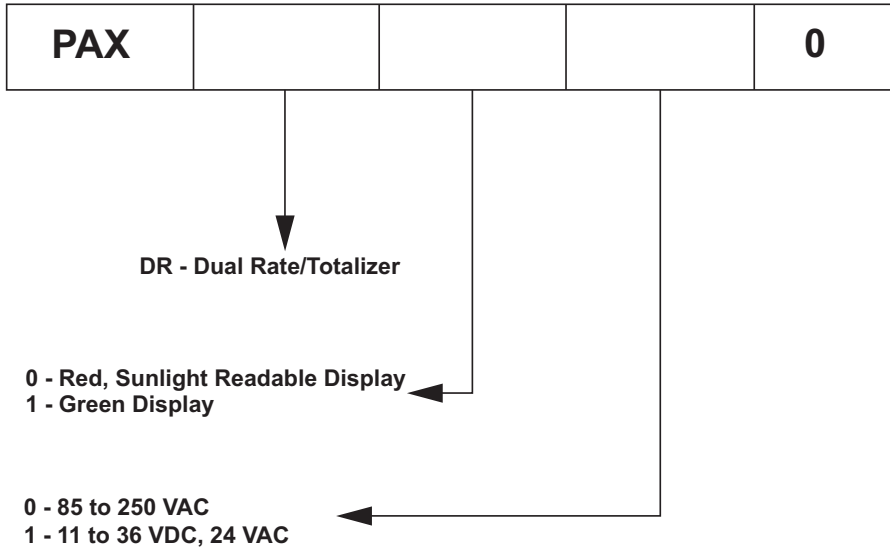

## Option Card Part Numbers

TYPE	MODEL NO.	DESCRIPTION	PART NUMBERS
Optional Plug-In Cards	PAXCDS	Dual Setpoint Relay Output Card	PAXCDS10
		Quad Setpoint Relay Output Card	PAXCDS20
		Quad Setpoint Sinking Open Collector Output Card	PAXCDS30
		Quad Setpoint Sourcing Open Collector Output Card	PAXCDS40
	PAXCDC	RS485 Serial Communications Card with Terminal Block	PAXCDC10
		Extended RS485 Serial Communications Card with Dual RJ11 Connector	PAXCDC1C
		RS232 Serial Communications Card with Terminal Block	PAXCDC20
		Extended RS232 Serial Communications Card with 9 Pin D Connector	PAXCDC2C
		DeviceNet Communications Card	PAXCDC30
		Modbus Communications Card with Terminal Block	PAXCDC40
		Extended Modbus Communications Card with Dual RJ11 Connector	PAXCDC4C
	Profibus-DP Communications Card	PAXCDC50	
	PAXCDL	Analog Output Card	PAXCDL10

# METER SPECIFICATIONS

- DISPLAY:** 6 digit, 0.56" (14.2 mm) red sunlight readable or standard green LED, intensity adjustable.
- POWER:**
  - AC Versions:
    - AC Power: 85 to 250 VAC, 50/60 Hz, 18 VA
    - Isolation: 2300 Vrms for 1 min. to all inputs and outputs. (300 V working)
  - DC Versions:
    - DC Power: 11 to 36 VDC, 14 W
    - (derate operating temperature to 40 °C if operating <15 VDC and three plug-in option cards are installed)
    - AC Power: 24 VAC, ± 10%, 50/60 Hz, 15 VA
    - Isolation: 500 Vrms for 1 min. to all inputs and outputs (50 V working).
- SENSOR POWER:** 12 VDC, ±10%, 100 mA max. Short circuit protected
- KEYPAD:** 3 programmable function keys, 5 keys total
- RATE DISPLAYS:**
  - Maximum Display: 5-digits
  - Display Range: 0 to 99999 (Rate A or B); -9999 to 99999 (Rate C)
  - Over/Under Range Display: "OL OL"
  - Annunciators (displayed in Digit 6): **A** - Rate A, **B** - Rate B, **C** - Rate C
  - Display Update Time: Adjustable 0.1 to 99.9 seconds
  - Maximum Frequency: See Maximum Signal Frequencies Table
  - Minimum Frequency: 0.01 Hz
  - Accuracy: ±0.01% of input signal frequency
- TOTALIZER DISPLAYS:**
  - Maximum Display: 8-digits
  - Display Range: ±99999999; For values greater than 6 digits, display alternates between high order (**BF** prefix) and low order digits.
  - Over/Under Range Display: "OL OL"
  - Annunciators: A, B and C along left side of display for selected Totalizer.
  - Maximum Frequency: See Maximum Signal Frequencies Table

**Maximum Signal Frequencies Table**

RATE ONLY (Totalizers A & B Disabled)	
Single Rate (A or B)	44 KHz <sup>1</sup> (with or without setpoints)
Dual Rate (A & B)	19 KHz <sup>1</sup> (with or without setpoints)

DUAL RATE WITH TOTALIZER(S)	Single Totalizer Enabled (A or B)		Both Totalizers Enabled (A & B) <sup>2</sup>	
	No	Yes	No	Yes
Setpoint(s) assigned to an enabled Totalizer ?	No	Yes	No	Yes
TOTALIZER A or B OPERATING MODE <sup>3</sup>	Maximum Frequency in KHz <sup>4</sup>			
Count x1	14	8.5	13	8.5
Count x2	14	8.5	10	7
Quadrature x1	9.5	9	8	4.5
Quadrature x2	9.5	8.5	7	4
Quadrature x4	9.5	5	N/A	N/A

**Notes:**

- These values apply with or without Rate C Calculation enabled.
- If both Totalizers are used with different operating modes, then the lower frequency listed applies to both Totalizers.
- See Programming Module 4 for Totalizer Operating Mode descriptions.
- Derate listed values by 15% if Totalizer C Calculation is enabled.

- INPUTS A and B:** DIP switch selectable to accept pulses from a variety of sources including switch contacts, TTL outputs, magnetic pickups and all standard Red Lion sensors.
  - Logic: Input trigger levels  $V_{IL} = 1.5$  V max.;  $V_{IH} = 3.75$  V min.
  - Current sinking: Internal 7.8 K $\Omega$  pull-up to +12 VDC,  $I_{MAX} = 1.9$  mA.
  - Current sourcing: Internal 3.9 K $\Omega$  pull-down, 7.3 mA max. @ 28 VDC,  $V_{MAX} = 30$  VDC.
  - Filter: Damping capacitor provided for switch contact bounce. Limits input frequency to 50 Hz and input pulse widths to 10 msec. minimum.
- Magnetic Pickup:**
  - Sensitivity: 200 mV peak
  - Hysteresis: 100 mV
  - Input impedance: 3.9 K $\Omega$  @ 60 Hz
  - Maximum input voltage: ±40 V peak, 30 Vrms
- Dual Count Modes:** When any dual count mode is used, then User Inputs 1 and/or 2 will accept the second signal of each signal pair. The user inputs do not have the Logic/Mag, HI/LO Freq, and Sink/Source input setup switches. The user inputs are inherently a logic input with no low frequency filtering. Any mechanical contacts used for these inputs in a dual count mode must be debounced externally. The user input may only be selected for sink/source by the User Jumper placement.

- USER INPUTS:** Three programmable user inputs
  - Max. Continuous Input: 30 VDC
  - Isolation To Sensor Input Commons: Not isolated
  - Logic State: Jumper selectable for sink/source logic

INPUT STATE	SINKING INPUTS 5.1 K $\Omega$ pull-up to +12 V	SOURCING INPUTS 5.1 K $\Omega$ pull-down
Active	$V_{IN} < 0.9$ VDC	$V_{IN} > 3.6$ VDC
Inactive	$V_{IN} > 3.6$ VDC	$V_{IN} < 0.9$ VDC

Response Time: 6 msec. typical; function dependent. Certain resets, stores and inhibits respond within 25  $\mu$ sec if an edge occurs with the associated totalizer or within 6 msec if no count edge occurs with the associated totalizer. These functions include **ERR5kL**, **ERR5kE**, **Inhibk**, **StorE**, and **Pr-r5k**. Once activated, all functions are latched for 50 msec min. to 100 msec max. After that period, another edge/level may be recognized.

- MEMORY:** Nonvolatile E<sup>2</sup>PROM retains all programmable parameters and display values when power is removed.
- CERTIFICATIONS AND COMPLIANCES:**
  - CE Approved**
    - EN 61326-1 Immunity to Industrial Locations
    - Emission EN 55011 Class A
    - IEC/EN 61010-1
  - Type 4X Enclosure rating (Face only)
  - IP65 Enclosure rating (Face only)
  - IP20 Enclosure rating (Rear of unit)
  - Refer to *EMC Installation Guidelines section of the bulletin for additional information.*
- ENVIRONMENTAL CONDITIONS:**
  - Operating Temperature Range: 0 to 50 °C (0 to 45 °C with all three plug-in cards installed)
  - Storage Temperature Range: -40 to 60 °C
  - Operating and Storage Humidity: 0 to 85% max. relative humidity non-condensing
  - Vibration to IEC 68-2-6: Operational 5-150 Hz, 2 g
  - Shock to IEC 68-2-27: Operational 25 g (10 g relay)
  - Altitude: Up to 2000 meters
- CONNECTIONS:** High compression cage-clamp terminal block
  - Wire Strip Length: 0.3" (7.5 mm)
  - Wire Gauge: 30-14 AWG copper wire
  - Torque: 4.5 inch-lbs (0.51 N-m) max.
- CONSTRUCTION:** This unit is rated for NEMA 4X/IP65 outdoor use. IP20 Touch safe. Installation Category II, Pollution Degree 2. One piece bezel/case. Flame resistant. Synthetic rubber keypad. Panel gasket and mounting clip included.
- WEIGHT:** 10.1 oz. (286 g)

# OPTIONAL PLUG-IN OUTPUT CARDS



**WARNING: Disconnect all power to the unit before installing Plug-in cards.**

## Adding Option Cards

The PAX and MPAX series meters can be fitted with up to three optional plug-in cards. The details for each plug-in card can be reviewed in the specification section below. Only one card from each function type can be installed at one time. The function types include Setpoint Alarms (PAXCDS), Communications (PAXCDC), and Analog Output (PAXCDL). The plug-in cards can be installed initially or at a later date.

## COMMUNICATION CARDS (PAXCDC)

A variety of communication protocols are available for the PAX and MPAX series. Only one of these cards can be installed at a time.

PAXCDC10 - RS485 Serial (Terminal)    PAXCDC30 - DeviceNet  
PAXCDC1C - RS485 Serial (Connector)    PAXCDC40 - Modbus (Terminal)  
PAXCDC20 - RS232 Serial (Terminal)    PAXCDC4C - Modbus (Connector)  
PAXCDC2C - RS232 Serial (Connector)    PAXCDC50 - Profibus-DP

### SERIAL COMMUNICATIONS CARD

**Type:** RS485 or RS232  
**Isolation To Sensor & User Input Commons:** 500 Vrms for 1 min.  
Working Voltage: 50 V. Not Isolated from all other commons.  
**Data:** 7/8 bits  
**Baud:** 300 to 19,200  
**Parity:** no, odd or even  
**Bus Address:** Selectable 0 to 99, Max. 32 meters per line (RS485)  
**Transmit Delay:** Selectable for 2 to 50 msec or 50 to 100 msec (RS485)

### DEVICENET™ CARD

**Compatibility:** Group 2 Server Only, not UCMM capable  
**Baud Rates:** 125 Kbaud, 250 Kbaud, and 500 Kbaud  
**Bus Interface:** Phillips 82C250 or equivalent with MIS wiring protection per DeviceNet™ Volume I Section 10.2.2.  
**Node Isolation:** Bus powered, isolated node  
**Host Isolation:** 500 Vrms for 1 minute (50 V working) between DeviceNet™ and meter input common.

### MODBUS CARD

**Type:** RS485; RTU and ASCII MODBUS modes  
**Isolation To Sensor & User Input Commons:** 500 Vrms for 1 minute.  
Working Voltage: 50 V. Not isolated from all other commons.  
**Baud Rates:** 300 to 38400.  
**Data:** 7/8 bits  
**Parity:** No, Odd, or Even  
**Addresses:** 1 to 247.  
**Transmit Delay:** Programmable; See Transmit Delay explanation.

### PROFIBUS-DP CARD

**Fieldbus Type:** Profibus-DP as per EN 50170, implemented with Siemens SPC3 ASIC  
**Conformance:** PNO Certified Profibus-DP Slave Device  
**Baud Rates:** Automatic baud rate detection in the range 9.6 Kbaud to 12 Mbaud  
**Station Address:** 0 to 125, set by rotary switches.  
**Connection:** 9-pin Female D-Sub connector  
**Network Isolation:** 500 Vrms for 1 minute (50 V working) between Profibus network and sensor and user input commons. Not isolated from all other commons.

## SETPOINT CARDS (PAXCDS)

The PAX and MPAX series has 4 available setpoint alarm output plug-in cards. Only one of these cards can be installed at a time. (Logic state of the outputs can be reversed in the programming.) These plug-in cards include:

PAXCDS10 - Dual Relay, FORM-C, Normally open & closed  
PAXCDS20 - Quad Relay, FORM-A, Normally open only  
PAXCDS30 - Isolated quad sinking NPN open collector  
PAXCDS40 - Isolated quad sourcing PNP open collector

### DUAL RELAY CARD

**Type:** Two FORM-C relays  
**Isolation To Sensor & User Input Commons:** 2000 Vrms for 1 min.  
Working Voltage: 240 Vrms  
**Contact Rating:**  
One Relay Energized: 5 amps @ 120/240 VAC or 28 VDC (resistive load),  
1/8 HP @120 VAC, inductive load  
Total current with both relays energized not to exceed 5 amps  
**Life Expectancy:** 100 K cycles min. at full load rating. External RC snubber extends relay life for operation with inductive loads  
**Response Time:** 5 msec. nominal pull-in with 3 msec. nominal release  
**Timed Output Accuracy:** Totalizer =  $\pm 0.01\% + 10$  msec.  
Rate =  $\pm 0.01\% + 20$  msec.

### QUAD RELAY CARD

**Type:** Four FORM-A relays  
**Isolation To Sensor & User Input Commons:** 2300 Vrms for 1 min.  
Working Voltage: 250 Vrms  
**Contact Rating:**  
One Relay Energized: 3 amps @ 250 VAC or 30 VDC (resistive load), 1/10 HP @120 VAC, inductive load  
Total current with all four relays energized not to exceed 4 amps  
**Life Expectancy:** 100K cycles min. at full load rating. External RC snubber extends relay life for operation with inductive loads  
**Response Time:** 5 msec. nominal pull-in with 3 msec. nominal release  
**Timed Output Accuracy:** Totalizer =  $\pm 0.01\% + 10$  msec.  
Rate =  $\pm 0.01\% + 20$  msec.

### QUAD SINKING OPEN COLLECTOR CARD

**Type:** Four isolated sinking NPN transistors.  
**Isolation To Sensor & User Input Commons:** 500 Vrms for 1 min.  
Working Voltage: 50 V. Not Isolated from all other commons.  
**Rating:** 100 mA max @  $V_{SAT} = 0.7$  V max.  $V_{MAX} = 30$  V  
**Response Time:** Counter = 25  $\mu$ sec; Rate = Low Update time  
**Timed Output Accuracy:** Totalizer =  $\pm 0.01\% + 10$  msec.  
Rate =  $\pm 0.01\% + 20$  msec.

### QUAD SOURCING OPEN COLLECTOR CARD

**Type:** Four isolated sourcing PNP transistors.  
**Isolation To Sensor & User Input Commons:** 500 Vrms for 1 min.  
Working Voltage: 50 V. Not Isolated from all other commons.  
**Rating:** Internal supply: 24 VDC  $\pm 10\%$ , 30 mA max. total  
External supply: 30 VDC max., 100 mA max. each output  
**Response Time:** Counter = 25  $\mu$ sec; Rate = Low Update time  
**Timed Output Accuracy:** Totalizer =  $\pm 0.01\% + 10$  msec.  
Rate =  $\pm 0.01\% + 20$  msec.

## ANALOG OUTPUT CARD (PAXCDL)

Either a 0(4)-20 mA or 0-10 V retransmitted linear DC output is available from the analog output plug-in card. The programmable output low and high scaling can be based on various display values. Reverse slope output is possible by reversing the scaling point positions.

PAXCDL10 - Retransmitted Analog Output Card

### ANALOG OUTPUT CARD

**Types:** 0 to 20 mA, 4 to 20 mA or 0 to 10 VDC  
**Isolation To Sensor & User Input Commons:** 500 Vrms for 1 min.  
Working Voltage: 50 V. Not Isolated from all other commons.  
**Accuracy:** 0.17% of FS (18 to 28°C); 0.4% of FS (0 to 50°C)  
**Resolution:** 1/3500  
**Compliance:** 10 VDC: 10 K $\Omega$  load min., 20 mA: 500  $\Omega$  load max.  
**Powered:** Self-powered (Active)  
**Response Time:** 50 msec. max., 15 msec. typ.

# 1.0 INSTALLING THE METER

## Installation

The PAX meets NEMA 4X/IP65 requirements when properly installed. The unit is intended to be mounted into an enclosed panel. Prepare the panel cutout to the dimensions shown. Remove the panel latch from the unit. Slide the panel gasket over the rear of the unit to the back of the bezel. The unit should be installed fully assembled. Insert the unit into the panel cutout.

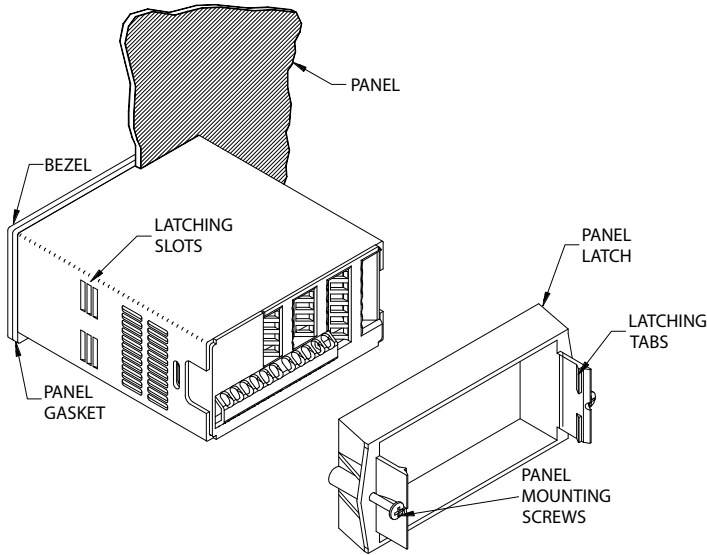

While holding the unit in place, push the panel latch over the rear of the unit so that the tabs of the panel latch engage in the slots on the case. The panel latch should be engaged in the farthest forward slot possible. To achieve a proper seal, tighten the latch screws evenly until the unit is snug in the panel (Torque to approximately 7 in-lbs [79N-cm]). Do not over-tighten the screws.

## Installation Environment

The unit should be installed in a location that does not exceed the operating temperature and provides good air circulation. Placing the unit near devices that generate excessive heat should be avoided.

The bezel should only be cleaned with a soft cloth and neutral soap product. Do NOT use solvents. Continuous exposure to direct sunlight may accelerate the aging process of the bezel.

Do not use tools of any kind (screwdrivers, pens, pencils, etc.) to operate the keypad of the unit.

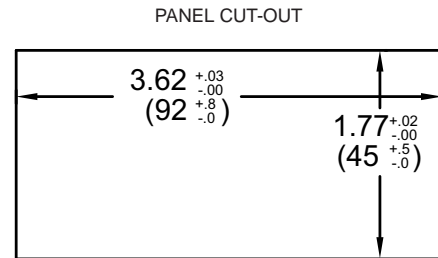

# 2.0 SETTING THE JUMPER AND DIP SWITCHES

To access the jumper and switches, remove the meter base from the meter case by firmly squeezing and pulling back on the side rear finger tabs. This should lower the latch below the case slot (which is located just in front of the finger tabs). It is recommended to release the latch on one side, then start the other side latch.

## 2.1 SETTING THE JUMPER

The meter has one jumper for user input logic. When using the user inputs this jumper must be set before applying power. The Main Circuit Board figure shows the location of the jumper and DIP switch.

The user input jumper determines signal logic for the user inputs, when they are used with user functions or for input signal direction. All user inputs are set by this jumper.

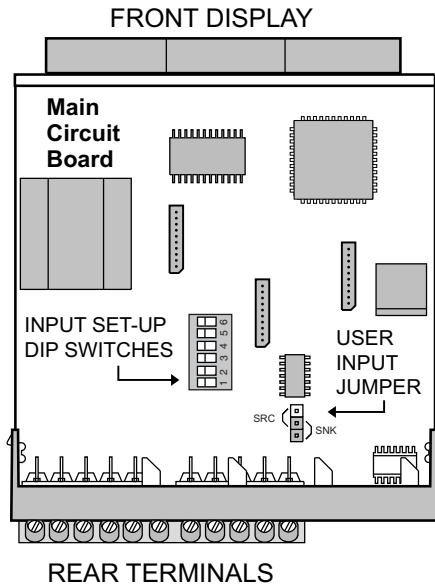

**Warning:** Exposed line voltage exists on the circuit boards. Remove all power to the meter and load circuits before accessing inside of the meter.

## 2.2 SETTING THE INPUT DIP SWITCHES

The meter has six DIP switches for Input A and Input B terminal set-up that must be set before applying power.

Input B LO Freq.	<input type="checkbox"/>	6	HI Freq.
Input B SRC.	<input type="checkbox"/>	5	SNK.
Input B MAG.	<input type="checkbox"/>	4	Logic
Input A LO Freq.	<input type="checkbox"/>	3	HI Freq.
Input A SRC.	<input type="checkbox"/>	2	SNK.
Input A MAG.	<input type="checkbox"/>	1	Logic

■ Factory Setting

### SWITCHES 1 and 4

**LOGIC:** Input trigger levels  $V_{IL} = 1.5 \text{ V max.}$ ;  $V_{IH} = 3.75 \text{ V min.}$

**MAG:** 200 mV peak input (must also have SRC on). Not recommended with counting applications.

### SWITCHES 2 and 5

**SNK.:** Adds internal 7.8 K $\Omega$  pull-up resistor to +12 VDC,  $I_{MAX} = 1.9 \text{ mA.}$

**SRC.:** Adds internal 3.9 K $\Omega$  pull-down resistor, 7.3 mA max. @ 28 VDC,  $V_{MAX} = 30 \text{ VDC.}$

### SWITCHES 3 and 6

**HI Frequency:** Removes damping capacitor and allows max. frequency.

**LO Frequency:** Adds a damping capacitor for switch contact bounce. Also limits input frequency to 50 Hz and input pulse widths to 10 msec.

# 3.0 INSTALLING PLUG-IN CARDS

The Plug-in cards are separately purchased optional cards that perform specific functions. These cards plug into the main circuit board of the meter. The Plug-in cards have many unique functions when used with the PAX.



**CAUTION:** The Plug-in card and main circuit board contain static sensitive components. Before handling the cards, discharge static charges from your body by touching a grounded bare metal object. Ideally, handle the cards at a static controlled clean workstation. Also, only handle the cards by the edges. Dirt, oil or other contaminants that may contact the cards can adversely affect circuit operation.

## To Install:

1. With the case open, locate the Plug-in card connector for the card type to be installed. The types are keyed by position with different main circuit board connector locations. When installing the card, hold the meter by the rear terminals and not by the front display board.\*
2. Install the Plug-in card by aligning the card terminals with the slot bay in the rear cover. Be sure the connector is fully engaged and the tab on the Plug-in card rests in the alignment slot on the display board.
3. Slide the meter base back into the case. Be sure the rear cover latches fully into the case.
4. Apply the Plug-in card label to the bottom side of the meter in the designated area. Do Not Cover the vents on the top surface of the meter. The surface of the case must be clean for the label to adhere properly.

## Quad Sourcing Open Collector Output Card Supply Select

\* If installing the Quad sourcing Plug-in Card (PAXCDS40), set the jumper for internal or external supply operation before continuing.

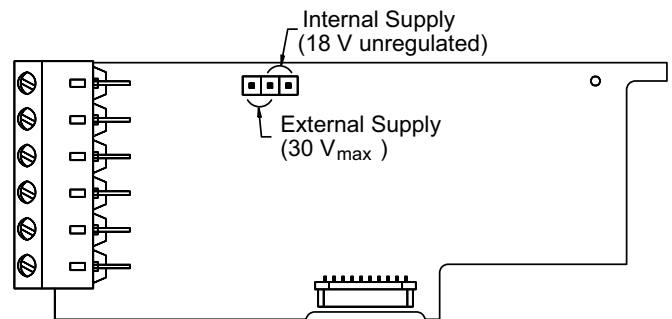
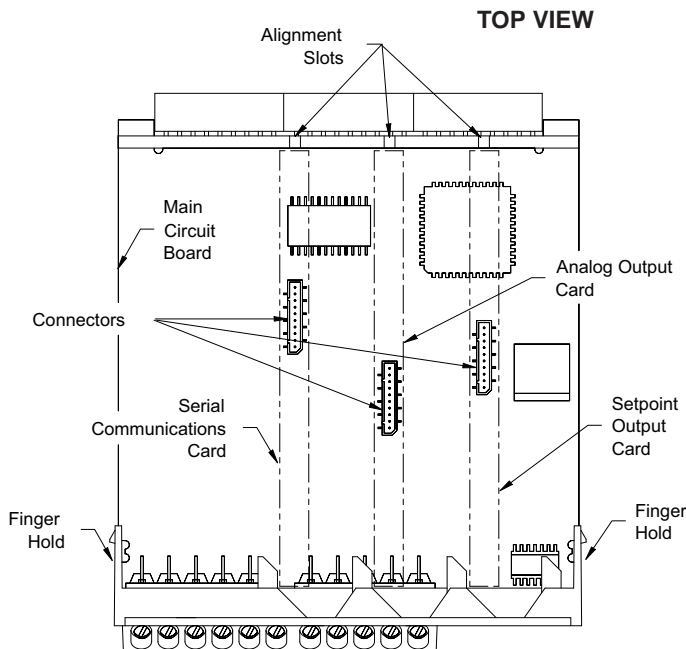



### 4.3 INPUT WIRING



**CAUTION:** Sensor input common is NOT isolated from user input common. In order to preserve the safety of the meter application, the sensor input common must be suitably isolated from hazardous live earth referenced voltage; or input common must be at protective earth ground potential. If not, hazardous voltage may be present at the User Inputs and User Input Common terminals. Appropriate considerations must then be given to the potential of the user input common with respect to earth ground; and the common of the isolated plug-in cards with respect to input common.

If you are wiring Input B, connect signal to Terminal 6 instead of 5, and set DIP switches 4, 5, and 6 to the positions shown for 1, 2, and 3.

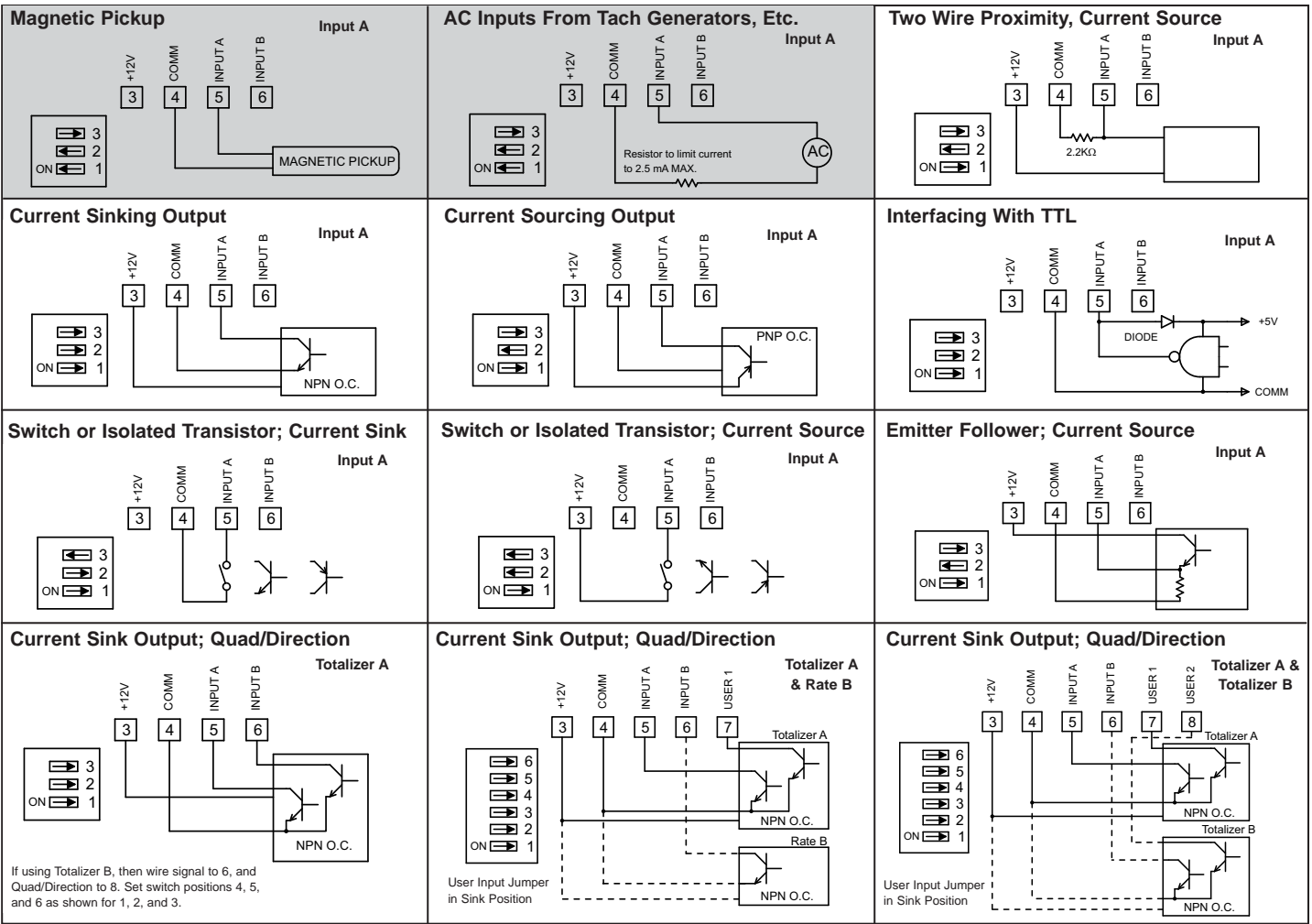

### 4.4 SETPOINT (ALARMS) WIRING

### 4.5 SERIAL COMMUNICATION WIRING

### 4.6 ANALOG OUTPUT WIRING

See appropriate plug-in card bulletin for details.

## 5.0 REVIEWING THE FRONT BUTTONS AND DISPLAY

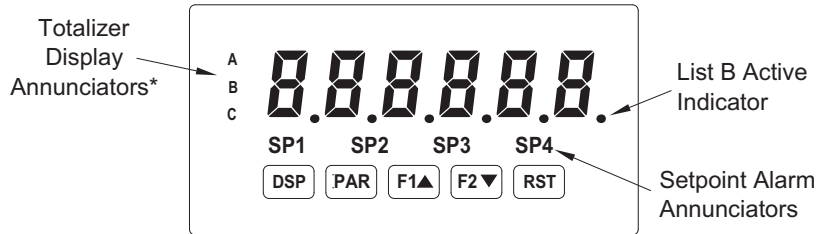

KEY	DISPLAY MODE OPERATION
DSP	Index display through the selected displays.
PAR	Access Programming Mode
F1▲	Function key 1; hold for 3 seconds for Second Function 1 **
F2▼	Function key 2; hold for 3 seconds for Second Function 2 **
RST	Reset (Function key) **

PROGRAMMING MODE OPERATION
Quit programming and return to Display Mode
Store selected parameter and index to next parameter
Increment selected parameter value or selections
Decrement selected parameter value or selections
Advances selected digit location in parameter values

\* Totalizer A, B, and C are locked out in Factory Settings.  
 \*\* Factory setting for the F1 F2 and RST keys is NO mode.



# 6.0 PROGRAMMING THE METER

## OVERVIEW

### PROGRAMMING MENU

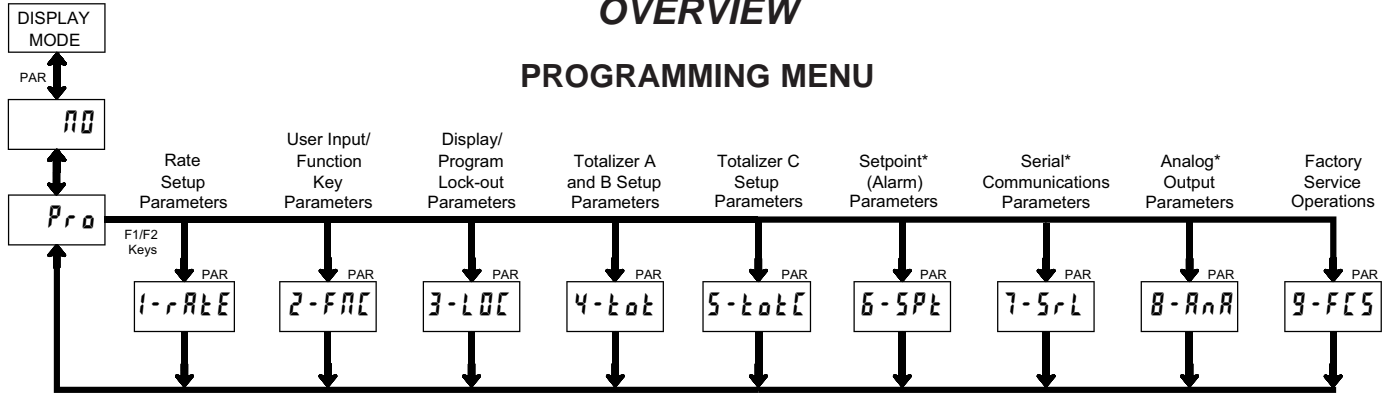

\* Only accessible with appropriate plug-in card.

### PROGRAMMING MODE ENTRY (PAR KEY)

The meter normally operates in the Display Mode. No parameters can be programmed in this mode. The Programming Mode is entered by pressing the **PAR** key. If it is not accessible then it is locked by either a security code, or a hardware lock.

Two types of programming modes are available. Quick Programming Mode permits only certain parameters to be viewed and/or modified. All meter functions continue to operate except the front panel keys change to Programming Mode Operations. Quick Programming Mode is configured in Module 3.

Full Programming Mode permits all parameters to be viewed and modified. In this mode, incoming counts may not be recognized correctly, the front panel keys change to Programming Mode Operations and certain user input functions are disabled. Throughout this document, Programming Mode always refers to "Full" Programming, unless "Quick Programming" is referenced.

### MODULE ENTRY (ARROW & PAR KEYS)

The Programming Menu is organized into nine modules. These modules group together parameters that are related in function. The display will alternate between **Pr o** and the present module. The arrow keys (**F1▲** and **F2▼**) are used to select the desired module. The displayed module is entered by pressing the **PAR** key.

### MODULE MENU (PAR KEY)

Each module has a separate module menu (which is shown at the start of each module discussion). The **PAR** key is pressed to advance to a particular parameter to be changed, without changing the programming of preceding parameters. After completing a module, the display will return to **Pr o**. Programming may continue by accessing additional modules.

### SELECTION / VALUE ENTRY (ARROW & PAR KEYS)

For each parameter, the display alternates between the present parameter and the selections/value for that parameter. The arrow keys (**F1▲** and **F2▼**) are used to move through the selections/values for that parameter. Pressing the **PAR** key, stores and activates the displayed selection/value. This also advances the meter to the next parameter.

For numeric values, the **RST** key may be used to select a specific digit to be changed. Once a digit is selected, the arrow keys are used to increment or decrement that digit to the desired number.

### PROGRAMMING MODE EXIT (DSP KEY or at Pr o PAR KEY)

The Programming Mode is exited by pressing the **DSP** key (from anywhere in the Programming Mode) or the **PAR** key (with **Pr o** displayed). This will commit any stored parameter changes to memory and return the meter to the Display Mode. If a parameter was just changed, the **PAR** key should be pressed to store the change before pressing the **DSP** key. (If power loss occurs before returning to the Display Mode, verify recent parameter changes.)

### PROGRAMMING TIPS

It is recommended to start with Module 1 and proceed through each module in sequence. If lost or confused while programming, press the **DSP** key and start over. When programming is complete, it is recommended to record the parameter programming on the Parameter Value Chart and lock out parameter programming with a user input or lock-out code.

### FACTORY SETTINGS

Factory Settings may be completely restored in Module 9. This is a good starting point if encountering programming problems. All factory settings are listed on the Parameter Value Chart following the Programming section.

### ALTERNATING SELECTION DISPLAY

In the explanation of the modules, the following dual display with arrows will appear. This is used to illustrate the display alternating between the parameter on top and the parameter's Factory Setting on the bottom. In most cases, selections or value ranges for the parameter will be listed on the right.

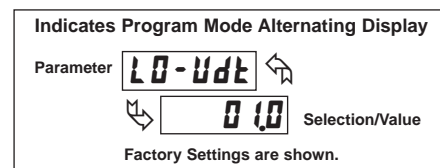

# 6.1 MODULE 1 - RATE SETUP PARAMETERS (1-rRtE)

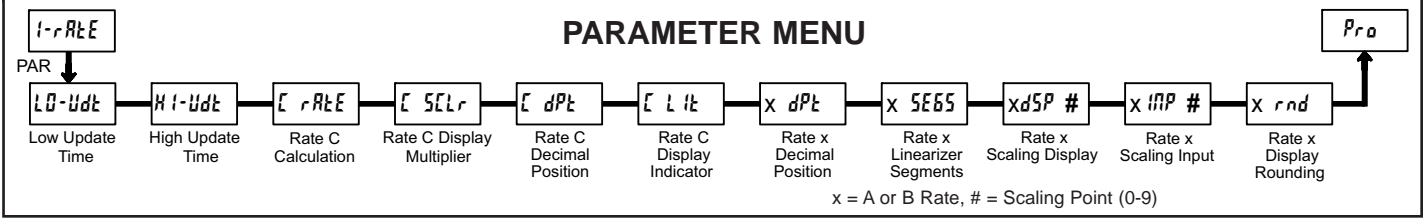

Module 1 is the programming for the Rate parameters. The Rate A signal is applied to Input A, and the Rate B signal is applied to Input B. The Rate values are shown with an indicator of **A**, **B** or **C** in display digit 6.

## LOW UPDATE TIME (DISPLAY UPDATE)

**LO-Udt** ↔  
↵ 1.0 0.1 to 99.9 seconds

The Low Update Time is the minimum amount of time between display updates for the Rate display. Values of 0.1 and 0.2 seconds will update the display correctly but may cause the display to appear unsteady. The factory setting of 1.0 will update the display every second minimum.

*Note: Update time settings apply to both Rate A and Rate B.*

## HIGH UPDATE TIME (DISPLAY ZERO)

**HI-Udt** ↔  
↵ 2.0 0.2 to 99.9 seconds

The High Update Time is the maximum amount of time before the Rate display is forced to zero. (For more explanation, refer to Input Frequency Calculation.) The High Update Time **must** be higher than the Low Update Time and higher than the desired slowest readable speed (one divided by pulses per second). The factory setting of 2.0, will force the display to zero for speeds below 0.5 Hz or a pulse every 2 seconds.

## RATE C CALCULATION

**rRtE** ↔  
↵ NONE 

<b>NONE</b>	<b>Add Ab</b>	<b>Sub Ab</b>
<b>Pct Ab</b>	<b>Pct Rt</b>	<b>Pct dr</b>

Select the calculation for Rate C display. Rate C calculation should be set to **NONE** when not in use. When set to **NONE**, the remaining Rate C parameters are not accessible.

SELECTION	DESCRIPTION
<b>NONE</b>	No Calculation. Rate C disabled.
<b>Add Ab</b>	SUM (A+B). Rate C shows the sum of Rate A and Rate B.
<b>Sub Ab</b>	DIFFERENCE (A-B). Rate C shows the difference of Rate A and Rate B.
<b>Pct Ab</b>	RATIO (A/B). Rate C shows the percentage of Rate A to Rate B.
<b>Pct Rt</b>	PERCENT OF TOTAL (A/A+B). Rate C shows the percentage of Rate A to the total of Rate A and Rate B.
<b>Pct dr</b>	PERCENT DRAW (A-B/B). Rate C shows the percent draw between Rate A and Rate B.

## RATE C DISPLAY MULTIPLIER

**SCLr** ↔  
↵ 1 

<b>1</b>	<b>10</b>
<b>100</b>	<b>1000</b>

Set the Display Multiplier to obtain the desired Rate C display resolution. For Rate C percentage calculations, the result is internally multiplied by 100 to show percent as a whole number. By using a Display Multiplier of 10, 100 or 1000, along with the proper decimal point position, percentage can be shown in tenths, hundredths or thousandths respectively.

## RATE C DECIMAL POSITION

**dPt** ↔  
↵ 0 

<b>0</b>	<b>0.00</b>	<b>0.0000</b>
<b>00</b>	<b>0.000</b>	

Select the decimal point position for Rate C display and any setpoint value assigned to Rate C.

## RATE C DISPLAY INDICATOR

**LI** ↔  
↵ ON **ON**    **OFF**

The Rate C display indicator in digit 6 may be turned OFF if desired. Rate A and Rate B display indicators are always shown.

*Note: Disabling Rate C indicator does NOT provide an additional digit for Rate C value display. The display range remains -9999 to 99999.*

## RATE A & B DECIMAL POSITION

**Ab dPt** ↔  
↵ 0 

<b>0</b>	<b>0.00</b>	<b>0.0000</b>
<b>00</b>	<b>0.000</b>	

When Rate C is enabled, this parameter sets the decimal point position for Rate A and B display (same position for both), and any setpoint value assigned to Rate A or Rate B. If Rate C is disabled, this parameter does not appear and separate decimal point positions can be selected for Rate A and Rate B.

## RATE A DECIMAL POSITION

**A dPt** ↔  
↵ 0 

<b>0</b>	<b>0.00</b>	<b>0.0000</b>
<b>00</b>	<b>0.000</b>	

This selects the decimal point position for Rate A display and any setpoint value assigned to Rate A. This parameter does not appear if Rate C is enabled.

## RATE A LINEARIZER SEGMENTS

**A SESS** ↔  
↵ 0 **0 to 9**

This parameter specifies the number of linear segments used for the Rate A Scaling function. Each linear segment has two scaling points which define the upper and lower endpoints of the segment. The number of segments used depends on the linearity of the process and the display accuracy required as described below.

### Linear Application – 2 Scaling Points

Linear processes use a single segment (two scaling points) to provide a linear Rate display from 0 up to the maximum input frequency. For typical zero based frequency measurements (0 Hz = 0 on display), leave **SESS=0** (factory setting). For non-zero based 2 scaling point applications, set **SESS=1**, to enter both the zero segment (**INP 0 & dSP 0**) and segment 1 (**INP 1 & dSP 1**).

## Non-linear Application – Up to 10 Scaling Points

Non-linear processes may utilize up to nine segments (ten scaling points) to provide a piece-wise linear approximation representing the non-linear function. The Rate display will be linear throughout each individual segment (i.e. between sequential scaling points). Thus, the greater the number of segments, the greater the conformity accuracy.

### About Scaling Points

Each Scaling Point is specified by two programmable parameters: A desired Rate Display Value (*dSP*) and a corresponding Rate Input Value (*iRP*). Scaling points are entered sequentially in ascending order of Rate Input Value.

Two scaling points must be programmed to define the upper and lower endpoints of the first linear segment. Setting *SEBS=0*, automatically factory sets the first scaling point to 0.0 for typical single segment, zero based applications. When multiple segments are used, the upper scaling point for a given segment becomes the lower scaling point for the next sequential segment. Thus, for each additional segment used, only one additional scaling point must be programmed.

The following chart shows the Scaling Points, the corresponding Parameter mnemonics, and the Factory Default Settings for each point.

SEGMENT	SCALING POINT	DISPLAY PARAMETER	DISPLAY DEFAULT	INPUT PARAMETER	INPUT DEFAULT
	1	<i>dSP 0</i>	000000	<i>iRP 0</i>	00000.0
1	2	<i>dSP 1</i>	001000	<i>iRP 1</i>	01000.0
2	3	<i>dSP 2</i>	002000	<i>iRP 2</i>	02000.0
3	4	<i>dSP 3</i>	003000	<i>iRP 3</i>	03000.0
4	5	<i>dSP 4</i>	004000	<i>iRP 4</i>	04000.0
5	6	<i>dSP 5</i>	005000	<i>iRP 5</i>	05000.0
6	7	<i>dSP 6</i>	006000	<i>iRP 6</i>	06000.0
7	8	<i>dSP 7</i>	007000	<i>iRP 7</i>	07000.0
8	9	<i>dSP 8</i>	008000	<i>iRP 8</i>	08000.0
9	10	<i>dSP 9</i>	009000	<i>iRP 9</i>	09000.0

### RATE A DISPLAY VALUE FOR SCALING POINT 1

**RdSP 0** ← → 0 to 999999  
 ← → **0**

Confirm the Rate A Display Value for the first Scaling Point is 0. This parameter is automatically set to 0 and does not appear when *SEBS=0*. (See Note)

### RATE A INPUT VALUE FOR SCALING POINT 1

**R iRP 0** ← → 0 to 999999  
 ← → **0.0**

Confirm the Rate A Input Value for the first Scaling Point is 0.0. (See Note)

Note: For all linear and most non-linear applications, the Scaling Point 1 parameters (*dSP 0* and *iRP 0*) should be set to 0 and 0.0 respectively. Consult the factory before using any non-zero values for Scaling Point 1. These parameters are automatically set to 0 and do not appear when *SEBS=0*.

### RATE A DISPLAY VALUE FOR SCALING POINT 2

**RdSP 1** ← → 0 to 999999  
 ← → **1000**

Enter the desired Rate A Display Value for the second Scaling Point by using the arrow keys.

### RATE A INPUT VALUE FOR SCALING POINT 2

**R iRP 1** ← → 0 to 999999  
 ← → **10000**

Enter the corresponding Rate A Input Value for the second Scaling Point by using the arrow keys. Rate Input values for scaling points can be entered by using the Key-in or the Applied method described below.

#### Key-in Method:

Enter the Rate Input value (*iRP*) that corresponds to the entered Rate Display value (*dSP*) by pressing the **F1** or **F2** keys. This value is always in pulses per second (Hz).

#### Applied Method:

Apply an external rate signal to the appropriate input terminals. At the Rate Input Value (*iRP*) press and hold the **F1** and **F2** keys at the same time. The applied input frequency (in Hz) will appear on the display. (To verify correct reading wait for at least the length of the Low Update Time. Then press and hold the **F1** and **F2** keys at the same time again. The new value should be  $\pm 0.1\%$  of the previous entered value.) Press **PAR** to enter the displayed frequency as the Rate Input value. To prevent the displayed value from being entered, press **DSP**. This will take the meter out of Programming Mode and the previous Rate Input value will remain.

### RATE A DISPLAY ROUNDING

**R rnd** ← → 1 5 20 100  
 ← → **1** 2 10 50

Rounding values other than one will round the Rate display to the nearest increment selected (e.g. rounding of '5' causes 122 to round to 120 and 123 to round to 125). Rounding starts at the least significant digit of the Rate display.

### RATE B DECIMAL POSITION

**b dPt** ← → 0 000 00000  
 ← → **0** 00 0000

This selects the decimal point position for Rate B display and any setpoint value assigned to Rate B. This parameter does not appear if Rate C is enabled

### RATE B LINEARIZER SEGMENTS

**b SEBS** ← → 0 to 9  
 ← → **0**

Select the number of linear segments used for the Rate B scaling function.

### RATE B DISPLAY VALUE FOR SCALING POINT 1

**bdSP 0** ← → 0 to 999999  
 ← → **0**

Confirm the Rate B Display Value for the first Scaling Point is 0. This parameter is automatically set to 0 and does not appear when *SEBS=0*. (See Note)

### RATE B INPUT VALUE FOR SCALING POINT 1

**b iRP 0** ← → 0 to 999999  
 ← → **0.0**

Confirm the Rate B Input Value for the first Scaling Point is 0.0. (See Note)

Note: For all linear and most non-linear applications, the Scaling Point 1 parameters (*dSP 0* and *iRP 0*) should be set to 0 and 0.0 respectively. Consult the factory before using any non-zero values for Scaling Point 1. These parameters are automatically set to 0 and do not appear when *SEBS=0*.

## RATE B DISPLAY VALUE FOR SCALING POINT 2



Enter the desired Rate B Display Value for the second Scaling Point by using the arrow keys.

## RATE B INPUT VALUE FOR SCALING POINT 2



Enter the corresponding Rate B Input Value for the second Scaling Point by using the arrow keys. Rate Input values for scaling points can be entered by using the Key-in or the Applied method.

## RATE B DISPLAY ROUNDING

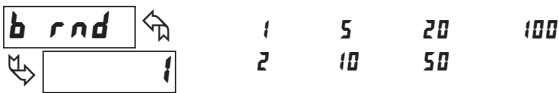

Rounding values other than one will round the Rate display to the nearest increment selected (e.g. rounding of '5' causes 122 to round to 120 and 123 to round to 125). Rounding starts at the least significant digit of the Rate display.

## RATE SCALING

To scale the Rate, enter a Scaling Display value with a corresponding Scaling Input value. (The Input value can be entered by Key-in or Applied Methods.) These values are internally plotted to a Display value of 0 and Input value of 0 Hz. A linear relationship is formed between these points to yield a rate display value that corresponds to the incoming input signal rate.

## SCALING CALCULATION FOR KEY-IN METHOD

If a display value versus input signal (in pulses per second) is known, then those values can be entered into Scaling Display (*dSPx*) and Scaling Input (*INPx*). No further calculations are needed.

If only the number of pulses per 'single' unit (i.e. # of pulses per foot) is known, then it can be entered as the Scaling Input value and the Scaling Display value will be entered as the following:

RATE PER	DISPLAY ( <i>dSPx</i> )	INPUT ( <i>INPx</i> )
Second	1	# of pulses per unit
Minute	60	# of pulses per unit
Hour	3600	# of pulses per unit

## NOTES:

- If # of pulses per unit is less than 1, multiply both Input and Display values by 10 or 100 as needed to obtain greater accuracy.
- If the Display value is raised or lowered, then Input value must be raised or lowered by the same proportion (i.e. Display value for per hour is entered by a third less (1200) then Input value is a third less of # of pulses per unit). The same is true if the Input value is raised or lowered, then Display value must be raised or lowered by the same proportion.
- Both values must be greater than 0.

## EXAMPLE:

- With 15.1 pulses per foot, show feet per minute in tenths. Scaling Display = 60.0 Scaling Input = 15.1.
- With 0.25 pulses per gallon, show whole gallons per hour. (To have greater accuracy, multiply both Input and Display values by 10.) Scaling Display = 36000 Scaling Input = 2.5.

## INPUT FREQUENCY CALCULATION

The meter determines the input frequency by summing the number of falling edges received during a sample period of time. The sample period begins on the first falling edge. At this falling edge, the meter starts accumulating time towards Low Update and High Update values. Also, the meter starts accumulating the number of falling edges. When the time reaches the Low Update Time value, the meter looks for one more falling edge to end the sample period. If a falling edge occurs (before the High Update Time value is reached), the Rate display will update to the new value and the next sample period will start on the same edge. If the High Update Time value is reached (without receiving a falling edge after reaching Low Update Time), then the sample period will end but the Rate display will be forced to zero. The High Update Time value must be greater than the Low Update Time value. Both values must be greater than 0.0. The input frequency calculated during the sample period, is then shown as a Rate value determined by either scaling method.

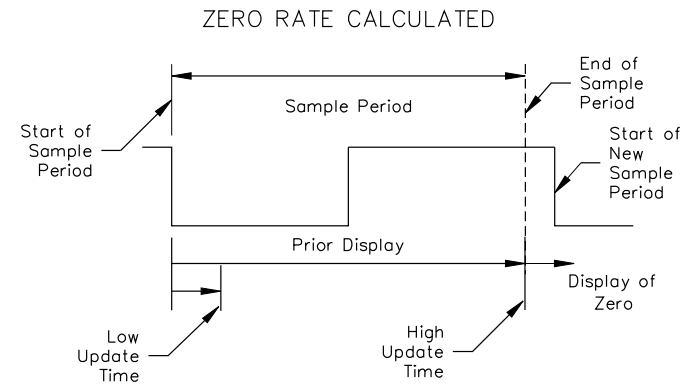
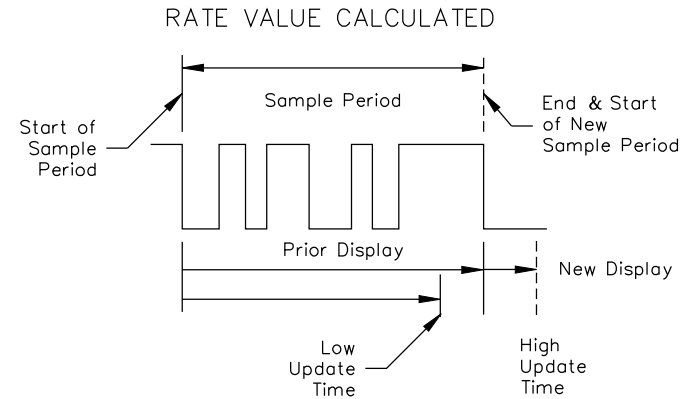

## 6.2 MODULE 2 - USER INPUT AND FRONT PANEL FUNCTION KEY PARAMETERS (2-FNC)

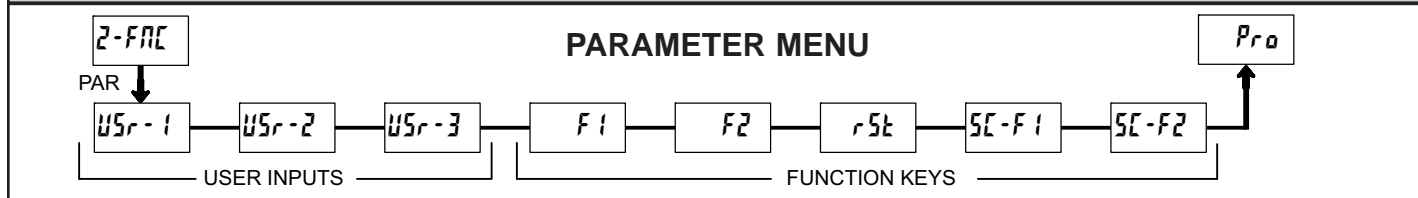

Module 2 is the programming for rear terminal user inputs and front panel function keys.

Three rear terminal user inputs are individually programmable to perform specific meter control functions. While in the Display Mode, the function is executed when the user input transitions to the active state. (Refer to the user input specifications for active state response times.) Certain user input functions are disabled while the meter is in “full” Programming Mode.

Three front panel function **F1**, **F2** and **RST** keys are also individually programmable to perform specific meter control functions. While in the Display Mode, the primary function is executed when the key is pressed. Holding the **F1** and **F2** function keys for three seconds executes a secondary function. It is possible to program a secondary function without a primary function. The front panel key functions are disabled while the meter is in Programming Mode.

In most cases, if more than one user input and/or function key is programmed for the same function, the maintained (level trigger) actions will be performed while at least one of those user inputs or function keys are activated. The momentary (edge trigger) actions are performed every time any of those user inputs or function keys transition to the active state.

Some of the user functions have a sublist of parameters. The sublist is accessed when **PAR** is pressed at the listed function. The function will only be performed for the parameters entered as **YES**. If a user input or function key is configured for a function with a sublist, then that sublist will need to be scrolled through each time to access the following user inputs or function keys parameters.

### NO FUNCTION

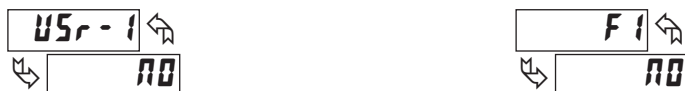

With this selection, NO function is performed. This is the factory setting for all user inputs and function keys.

**NOTE:** When a user input is used to accept a quad or directional input signal, then that user input should be programmed for NO function.

### PROGRAMMING MODE LOCK-OUT

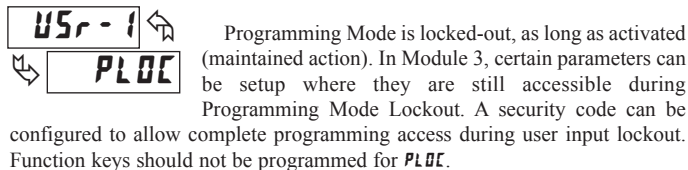

Programming Mode is locked-out, as long as activated (maintained action). In Module 3, certain parameters can be setup where they are still accessible during Programming Mode Lockout. A security code can be configured to allow complete programming access during user input lockout. Function keys should not be programmed for **PLDC**.

### ADVANCE DISPLAY



When activated (momentary action), the display advances to the next display that is not locked out from the Display Mode.

### RESET DISPLAY



When activated (momentary action), the shown display is reset.

### EXCHANGE PARAMETER LISTS



Two lists of values are available for **SP-1**, **SP-2**, **SP-3**, **SP-4**, **ASCFAE**, **bSEFAE**, **ESEFAE**, **ACntLd**, **bCntLd**. The two lists are named **L1St-A** and **L1St-B**. If a user input is used to select the list then **L1St-A** is selected when the user input is not active and **L1St-B** is selected when the user input is active (maintained action). If a front panel key is used to select the list, then the list will toggle for each key press (momentary action). The meter will suspend ALL operations for approximately 1 msec. while the new values are loaded. The display will indicate which list is active when the list is changed or when entering any Programming Mode. In addition, the decimal point to the right of digit 1 is displayed when List B is active.

To program the values for **L1St-A** and **L1St-B**, first complete the programming of all the parameters. Exit programming and switch to the other list. Re-enter programming and enter the values for **SP-1**, **SP-2**, **SP-3**, **SP-4**, **ASCFAE**, **bSEFAE**, **ESEFAE**, **ACntLd**, **bCntLd**. If any other parameters are changed then the other list values must be reprogrammed.

### PRINT REQUEST



The meter issues a block print through the serial port when activated. The data transmitted during the print request is configured in Module 7. If the user input is still active after the transmission is complete (about 100 msec.), an additional transmission will occur. Only one transmission will take place with each function key depression. This selection will only function when a serial communications Plug-in card is installed in the meter.

### PRINT REQUEST AND RESET DISPLAYS



The meter issues a block print through the serial port when activated just like the Print Request function. In addition, when activated (momentary action), the meter performs a reset of the totalizer displays configured as **YES**. The print aspect of this action only functions when a serial communication plug-in card is installed. The reset action functions regardless.

DISPLAY	DESCRIPTION	FACTORY
<b>A tot</b>	Totalizer A	<b>NO</b>
<b>b tot</b>	Totalizer B	<b>NO</b>

### TOTALIZER MAINTAINED (LEVEL) RESET AND INHIBIT



The meter performs a reset and inhibits the totalizer displays configured as **YE5**, as long as activated (maintained action).

DISPLAY	DESCRIPTION	FACTORY
A tot	Totalizer A	NO
B tot	Totalizer B	NO

### TOTALIZER MOMENTARY (EDGE) RESET



When activated (momentary action), the meter resets the displays configured as **YE5**. (Momentary resets improve max. input frequencies over maintained resets.)

DISPLAY	DESCRIPTION	FACTORY
A tot	Totalizer A	NO
B tot	Totalizer B	NO

### TOTALIZER INHIBIT



The meter inhibits the totalizer displays configured as **YE5**, as long as activated (maintained action).

DISPLAY	DESCRIPTION	FACTORY
A tot	Totalizer A	NO
B tot	Totalizer B	NO

### STORE TOTALIZER DISPLAY



The meter holds (freeze) the displays configured as **YE5**, as long as activated (maintained action). Internally the totalizer values continue to update.

DISPLAY	DESCRIPTION	FACTORY
A tot	Totalizer A	NO
B tot	Totalizer B	NO

### DEACTIVATE SETPOINT MAINTAINED (LEVEL)



The meter deactivates the setpoints configured as **YE5**, as long as activated (maintained action). This action only functions with a Setpoint card installed.

DISPLAY	DESCRIPTION	FACTORY
SP-1	Setpoint 1	NO
SP-2	Setpoint 2	NO
SP-3	Setpoint 3	NO
SP-4	Setpoint 4	NO

### DEACTIVATE SETPOINT MOMENTARY (EDGE)



When activated (momentary action), the meter deactivates the setpoints configured as **YE5**. This action only functions with a Setpoint card installed.

DISPLAY	DESCRIPTION	FACTORY
SP-1	Setpoint 1	NO
SP-2	Setpoint 2	NO
SP-3	Setpoint 3	NO
SP-4	Setpoint 4	NO

### HOLD SETPOINT STATE



The meter holds the state of the setpoints configured as **YE5**, as long as activated (maintained action). This action only functions with a Setpoint plug-in card installed.

DISPLAY	DESCRIPTION	FACTORY
SP-1	Setpoint 1	NO
SP-2	Setpoint 2	NO
SP-3	Setpoint 3	NO
SP-4	Setpoint 4	NO

### ACTIVATE SETPOINT MAINTAINED (LEVEL)



The meter activates the setpoints configured as **YE5**, as long as activated (maintained action). This action only functions with a Setpoint card installed.

DISPLAY	DESCRIPTION	FACTORY
SP-1	Setpoint 1	NO
SP-2	Setpoint 2	NO
SP-3	Setpoint 3	NO
SP-4	Setpoint 4	NO

### ACTIVATE SETPOINT MOMENTARY (EDGE)



When activated (momentary action), the meter activates the setpoints configured as **YE5**. This action only functions with a Setpoint card installed.

DISPLAY	DESCRIPTION	FACTORY
SP-1	Setpoint 1	NO
SP-2	Setpoint 2	NO
SP-3	Setpoint 3	NO
SP-4	Setpoint 4	NO

### CHANGE DISPLAY INTENSITY LEVEL



When activated (momentary action), the display intensity changes to the next intensity level (1 of 4). The four levels correspond to Display Intensity Level (**d-LEU**) settings of 0, 3, 8 & 15. The intensity level, when changed via the User Input/ Function Key, is saved at power-down, so the meter will power-up at the same intensity level.

# 6.3 MODULE 3 - DISPLAY AND PROGRAM LOCK-OUT PARAMETERS (3-LOC)

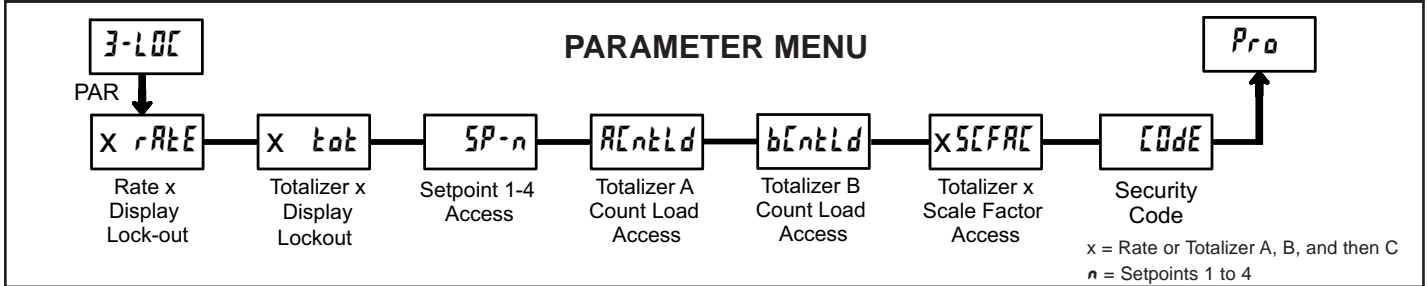

Module 3 is the programming for Display lock-out and “Full” and “Quick” Program lock-out.

When in the Display Mode, the available displays can be read consecutively by repeatedly pressing the **DSP** key. An annunciator indicates the display being shown. These displays can be locked from being visible. It is recommended that the display be set to **LOC** when the corresponding function is not used.

SELECTION	DESCRIPTION
<b>rEd</b>	Visible in Display Mode
<b>LOC</b>	Not visible in Display Mode

“Full” Programming Mode permits all parameters to be viewed and modified. This Programming Mode can be locked with a security code and/or user input. When locked and the **PAR** key is pressed, the meter enters a Quick Programming Mode. In this mode, setpoint, count load and scale factor values can still be read and/or changed per the selections below. The Display Intensity Level (**d-LE#**) parameter also appears whenever Quick Programming Mode is enabled, and the security code is greater than zero.

SELECTION	DESCRIPTION
<b>rEd</b>	Visible but not changeable in Quick Programming Mode
<b>Ent</b>	Visible and changeable in Quick Programming Mode
<b>LOC</b>	Not visible in Quick Programming Mode

### RATE A B C DISPLAY LOCK-OUT TOTALIZER A B C DISPLAY LOCK-OUT

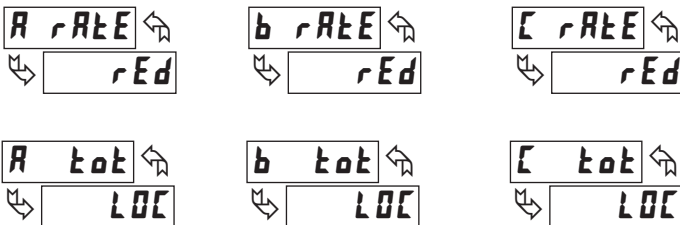

These displays can be programmed for **LOC** or **rEd**.

### SETPOINT 1 to 4 ACCESS LOCK-OUT

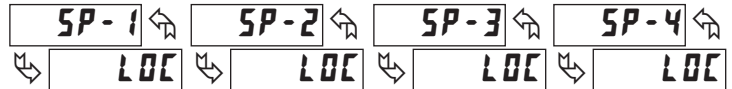

The setpoint values can be programmed for **LOC**, **rEd**, or **Ent**. Accessible only with a Setpoint Plug-in card installed.

### TOTALIZER A and B COUNT LOAD ACCESS LOCK-OUT



Count Load values can be programmed for **LOC**, **rEd**, or **Ent**.

### TOTALIZER A B C SCALE FACTOR ACCESS LOCK-OUT



The Scale Factor values can be programmed for **LOC**, **rEd**, or **Ent**.

### SECURITY CODE



Entry of a non-zero value will cause the prompt **COdE** to appear when trying to access the “Full” Programming Mode. Access will only be allowed after entering a matching security code or universal code of **222**. With this lock-out, a user input would not have to be configured for Program Lock-out. However, this lock-out is overridden by an inactive user input configured for Program Lock-out.

### PROGRAMMING MODE ACCESS

SECURITY CODE	USER INPUT CONFIGURED	USER INPUT STATE	WHEN PAR KEY IS PRESSED	“FULL” PROGRAMMING MODE ACCESS
0	not <b>PLOC</b>	—	“Full” Programming	Immediate access.
>0	not <b>PLOC</b>	—	Quick Programming w/Display Intensity	After Quick Programming with correct code # at <b>COdE</b> prompt.
>0	<b>PLOC</b>	Active	Quick Programming w/Display Intensity	After Quick Programming with correct code # at <b>COdE</b> prompt.
>0	<b>PLOC</b>	Not Active	“Full” Programming	Immediate access.
0	<b>PLOC</b>	Active	Quick Programming	No access
0	<b>PLOC</b>	Not Active	“Full” Programming	Immediate access.

Throughout this document, Programming Mode always refers to “Full” Programming (all meter parameters are accessible), unless “Quick Programming” is referenced.

# 6.4 MODULE 4 - TOTALIZER A & B SETUP PARAMETERS (4-tot)

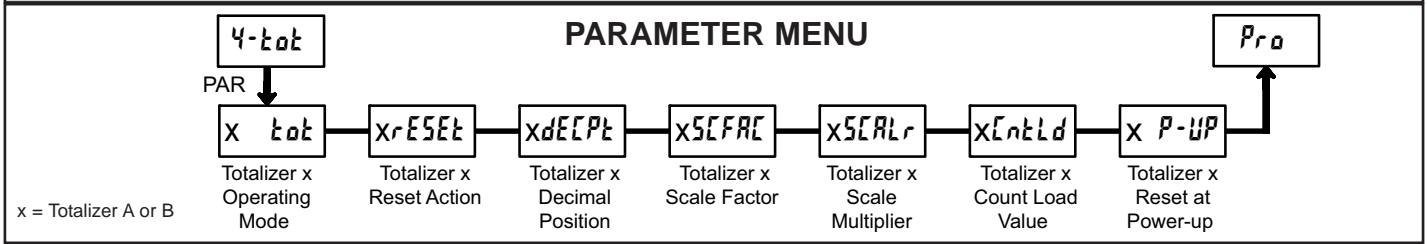

Module 4 is the programming for Totalizer A and Totalizer B. Totalizer B parameters follow Totalizer A. For maximum input frequency, the totalizers should be set to mode NONE when they are not in use. When set to NONE, the remaining related parameters are not accessible. A corresponding annunciator indicates the totalizer being shown in the Display Mode. An Exchange Parameter Lists feature for scale factors and count load values is explained in Module 2.

## TOTALIZER A OPERATING MODE

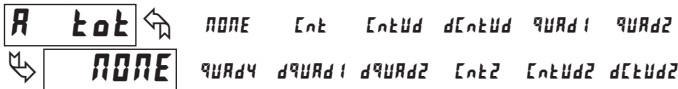

Select the operating mode for Totalizer A.

SELECTION	MODE	DESCRIPTION
NONE		Does not count.
Cnt	Count X1	Adds Input A falling edge.
CntUd	Count X1 w/direction	Adds Input A falling edge if Input B is high. Subtracts Input A falling edge if Input B is low.
dCntUd	Count X1 w/direction*	Adds Input A falling edge if User 1 is high. Subtracts Input A falling edge if User 1 is low.
QUAD 1	Quad X1	Adds Input A rising edge when Input B is high. Subtracts Input A falling edge when Input B is high.
QUAD 2	Quad X2	Adds Input A rising edge when Input B is high and Input A falling edge when Input B is low. Subtracts Input A falling edge when Input B is high and Input A rising edge when Input B is low.
QUAD 4	Quad X4	Adds Input A rising edge when Input B is high, Input A falling edge when Input B is low, Input B rising edge when Input A is low, and Input B falling edge when Input A is high. Subtracts Input A falling edge when Input B is high, Input A rising edge when Input B is low, Input B rising edge when Input A is high, and Input B falling edge when Input A is low.
dQUAD 1	Quad X1*	Adds Input A rising edge when User 1 is high. Subtracts Input A falling edge when User 1 is high.
dQUAD 2	Quad X2*	Adds Input A rising edge when User 1 is high and Input A falling edge when User 1 is low. Subtracts Input A falling edge when User 1 is high and Input A rising edge when User 1 is low.
Cnt2	Count X2	Adds Input A rising and falling edges.
CntUd2	Count X2 w/direction	Adds Input A rising and falling edges if Input B is high. Subtracts Input A rising and falling edge if Input B is low.
dCntUd2	Count X2 w/direction*	Adds Input A rising and falling edges if User 1 is high. Subtracts Input A rising and falling edge if User 1 is low.

\* Dual Count mode (d), where Inputs A and B are both used for count signals. User 1 accepts Input A direction or quadrature signal.

## TOTALIZER A RESET ACTION



When Totalizer A is reset, it returns to zero or Totalizer A count load value. This reset action affects all Totalizer A resets, except the Setpoint Totalizer Auto Reset in Module 6.

## TOTALIZER A DECIMAL POSITION



This selects the decimal point position for Totalizer A, Totalizer A Count Load Value, and any setpoint value assigned to Totalizer A. The selection will also affect Totalizer A scale factor calculations.

When Totalizer C is enabled, this setting applies to both Totalizer A and B displays (same position for both). If Totalizer C is disabled, separate decimal point positions can be selected for Totalizer A and Totalizer B.

## TOTALIZER A SCALE FACTOR

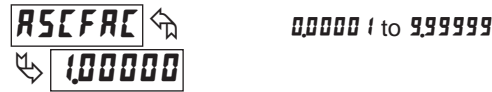

The number of input counts is multiplied by the scale factor and the scale multiplier to obtain the desired process value. A scale factor of 1.00000 will result in the display of the actual number of input counts. (Details on scaling calculations are explained at the end of this section.)

## TOTALIZER A SCALE MULTIPLIER



The number of input counts is multiplied by the scale multiplier and the scale factor to obtain the desired process value. A scale multiplier of 1 will result in only the scale factor affecting the display. (Details on scaling calculations are explained at the end of this section.)

## TOTALIZER A COUNT LOAD VALUE

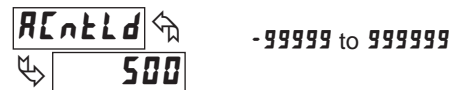

When reset to count load action is selected, Totalizer A will reset to this value.

## TOTALIZER A RESET AT POWER-UP



Totalizer A may be programmed to reset at each meter power-up.



### TOTALIZER B OPERATING MODE

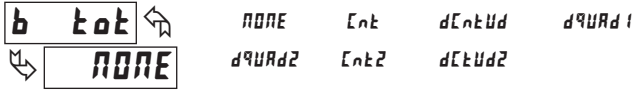

Select the operating mode for Totalizer B.

SELECTION	MODE	DESCRIPTION
NONE		Does not count.
Cnt	Count X1	Adds Input B falling edge.
dCntUd	Count X1 w/direction*	Adds Input B falling edge if User 2 is high. Subtracts Input B falling edge if User 2 is low.
dQuAd1	Quad X1*	Adds Input B rising edge when User 2 is high. Subtracts Input B falling edge when User 2 is high
dQuAd2	Quad X2*	Adds Input B rising edge when User 2 is high and Input B falling edge when User 2 is low. Subtracts Input B falling edge when User 2 is high and Input B rising edge when User 2 is low.
Cnt2	Count X2	Adds Input B rising and falling edges.
dCntUd2	Count X2 w/direction*	Adds Input B rising and falling edges if User 2 is high. Subtracts Input B rising and falling edge if User 2 is low.

\* Dual Count mode (d), where Inputs A and B are both used for count signals. User 2 accepts Input B direction or quadrature signal.

### TOTALIZER B RESET ACTION



When Totalizer B is reset, it returns to zero or Totalizer B count load value. This reset action affects all Totalizer B resets, except the Setpoint Totalizer Auto Reset in Module 6.

### TOTALIZER B DECIMAL POSITION



This selects the decimal point position for Totalizer B, Totalizer B Count Load values, and any setpoint value assigned to Totalizer B. The selection will also affect Totalizer B scale factor calculations. This parameter does not appear if Totalizer C is enabled.

### TOTALIZER B SCALE FACTOR



The number of input counts is multiplied by the scale factor and the scale multiplier to obtain the desired process value. A scale factor of 1.00000 will result in the display of the actual number of input counts. (Details on scaling calculations are explained at the end of this section.)

### TOTALIZER B SCALE MULTIPLIER



The number of input counts is multiplied by the scale multiplier and the scale factor to obtain the desired process value. A scale multiplier of 1 will result in only the scale factor affecting the display. (Details on scaling calculations are explained at the end of this section.)

### TOTALIZER B COUNT LOAD VALUE



When reset to count load action is selected, Totalizer B will reset to this value.

### TOTALIZER B RESET AT POWER-UP



Totalizer B may be programmed to reset at each meter power-up.

### 8 DIGIT TOTALIZER VALUES

Any totalizer display value below -99999 or above 999999 (less decimal point) will consist of a two part display. This display alternates between the 6 least significant digits and the remaining most significant digits beginning with "BF" in the display. If the display exceeds ± 99999999 the display will flash 0L0L to indicate an 8 digit overflow. Outputs cannot be set to totalizer values above 6 digits. The annunciator, indicating the totalizer being displayed, will flash when the value is above 6 digits.

### SCALING CALCULATIONS

Each totalizer has the ability to scale an input signal to a desired display value. This is accomplished by the totalizer mode (x-tot), scale factor (xSCFAC), scale multiplier (xSCALr) and decimal point (xDECpt). The scale factor is calculated using:

$$SF (xSCFAC) = \frac{\text{Desired Display Decimal DDD}}{(\text{Number of pulses per 'single' unit} \times TM \times SM)}$$

Where:

Desired Display Decimal DDD	xDECpt	Totalizer Decimal Selection
1	0	None
10	0.0	Tenths
100	0.00	Hundredths
1000	0.000	Thousandths
10000	0.0000	Ten Thousandths
100000	0.00000	Hundred Thousandths

**Number of pulses per 'single' unit:** pulses per unit generated by the process (i.e. # of pulses per foot)

**TM:** Totalizer Mode(x-tot) times factor of the mode 1,2 or 4.

**SM:** Scale Multiplier (xSCALr) selection of 1, 0.1 or 0.01.

**Example:**

- Show feet to the hundredths (0.00) with 100 pulses per foot: Scale Factor would be  $100 / (100 \times 1 \times 1) = 1$  (In this case, the scale multiplier and totalizer mode factor are 1)
- Show feet with 120 pulses per foot: Scale Factor would be  $1 / (120 \times 1 \times 1) = 0.0083333$ . (In this case, the scale multiplier of 0.01 could be used:  $1 / (120 \times 1 \times 0.01) = 0.83333$  or show to hundredths (0.00):  $100 / (120 \times 1 \times 1) = 0.8333$ .)

### General Rules on Scaling

- It is recommended that, the scale factor be as close as possible to, but not exceeding 1.00000. This can be accomplished by increasing or decreasing the totalizer decimal point position, using the scale multiplier, or selecting a different totalizer mode.
- To double the number of pulses per unit, use totalizer modes direction X2 or quad X2. To increase it by four times, use totalizer mode quad X4. Using these modes will decrease the maximum input frequency.
- A scale factor greater than 1.00000 will cause Totalizer display rounding. In this case, digit jumps could be caused by the internal count register rounding the display. The precision of a totalizer application cannot be improved by using a scale factor greater than 1.00000.
- The number of pulses per single unit must be greater than or equal to the DDD value for the scale factor to be less than or equal to one.
- Lowering the scale factor can be accomplished by lowering the totalizer decimal position. (Example: 100 (Hundredths)/10 pulses = 10.000 lowering to 10 (Tenths)/10 = 1.000.)

# 6.5 MODULE 5 - TOTALIZER C SETUP PARAMETERS (5-totC)

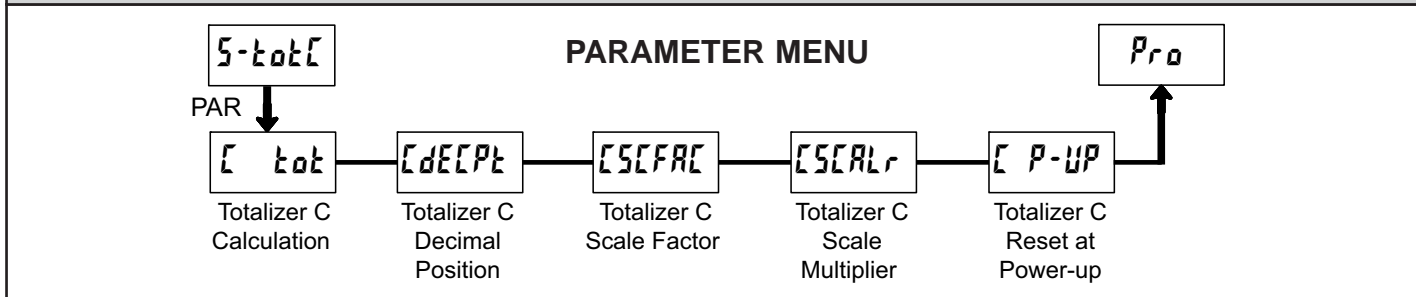

Module 5 is the programming for Totalizer C. For maximum input frequency, the Totalizer C Calculation should be set to **NONE** when not in use. When set to **NONE**, the remaining Totalizer C parameters are not accessible. The C annunciator indicates that Totalizer C is being shown in the Display Mode. An Exchange Parameter List feature for the Scale Factor is explained in Module 2.

## TOTALIZER C CALCULATION

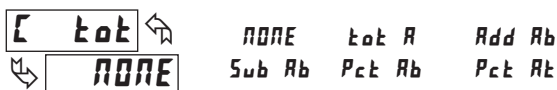

Select the calculation for Totalizer C display.

SELECTION	ACTION
<b>NONE</b>	No Calculation. Totalizer C disabled.
<b>tot A</b>	TOTALIZER A - Totalizer C shows Totalizer A with additional scaling applied per the Totalizer C scaling parameters.
<b>Add Ab</b>	SUM (A+B). Totalizer C shows the sum of Totalizer A and Totalizer B.
<b>Sub Ab</b>	DIFFERENCE (A-B). Totalizer C shows the difference of Totalizer A and Totalizer B.
<b>Pct Ab</b>	RATIO (A/B). Totalizer C shows the percentage of Totalizer A to Totalizer B.
<b>Pct At</b>	PERCENT OF TOTAL (A/A+B). Totalizer C shows the percentage of Totalizer A to the sum of Totalizer A and Totalizer B.

## TOTALIZER C DECIMAL POSITION



This selects the decimal point position for Totalizer C and any setpoint value assigned to Totalizer C. The selection will also affect Totalizer C scale factor calculations.

## TOTALIZER C SCALE FACTOR

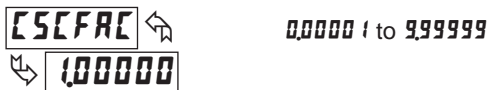

The result of the Totalizer C calculation is multiplied by the Scale Factor and Scale Multiplier to obtain the Totalizer C display value. Normally, a scale factor of 1.00000 is used to show the calculated result without any further scaling applied. If however, additional scaling is needed, the scale factor can be set to provide the desired reading.

## TOTALIZER C SCALE MULTIPLIER



Set the Scale Multiplier to provide the desired Totalizer C display resolution. For Totalizer C percentage calculations, the result is internally multiplied by 10,000 to show percentage in hundredths with a scale multiplier of 1 (select 2 decimal places). By using a scale multiplier of 0.1 or 0.01, along with the proper decimal point position, the display can be divided down to show percentage in tenths or in whole numbers respectively.

## TOTALIZER C RESET AT POWER-UP



Totalizer C may be programmed to reset at each meter power-up.

# 6.6 MODULE 6 - SETPOINT (ALARM) PARAMETERS (6-SPt)

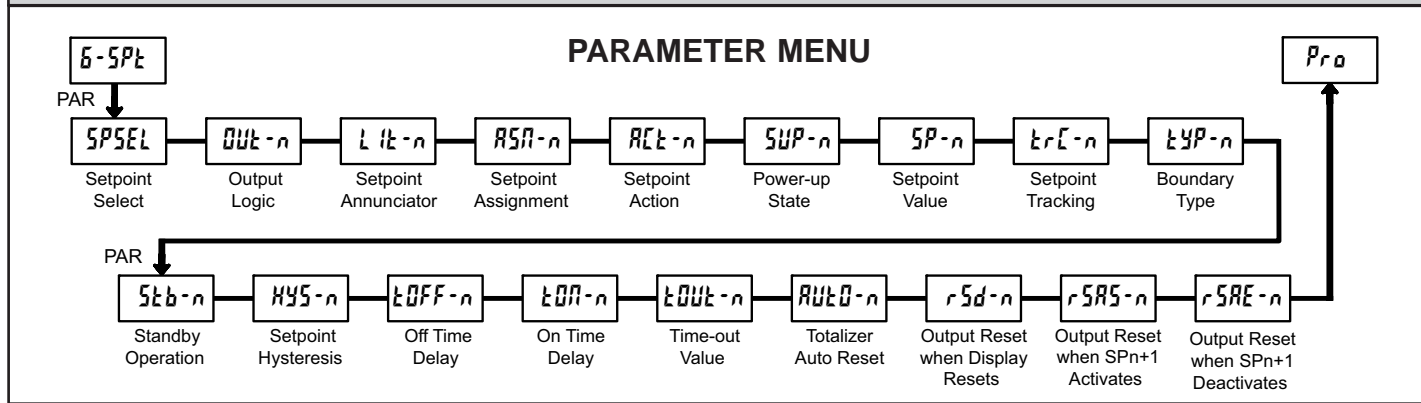

Module 6 is the programming for the setpoint (alarms) output parameters. To have setpoint outputs, a setpoint Plug-in card needs to be installed into the PAX (see Ordering Information). Depending on the card installed, there will be two or four setpoint outputs available. For maximum input frequency, unused Setpoints should be configured for **OFF** action. The Setpoint Assignment and the Setpoint Action determine certain setpoint parameter availability. The chart below illustrates this.

## SETPOINT PARAMETER AVAILABILITY

PARAMETER	DESCRIPTION	RATE ASSIGNMENT			TOTALIZER ASSIGNMENT		
		TIMED OUT tOUT	BOUNDARY bOUND	LATCH LATCH	TIMED OUT tOUT	BOUNDARY * bOUND	LATCH LATCH
OUT-n	Setpoint Output Logic	Yes	Yes	Yes	Yes	Yes	Yes
LIt-n	Setpoint Annunciator	Yes	Yes	Yes	Yes	Yes	Yes
SUP-n	Setpoint Power-Up State	No	No	Yes	No	No	Yes
SP-n	Setpoint Value	Yes	Yes	Yes	Yes	Yes	Yes
trc-n	Setpoint Tracking	Yes	Yes	Yes	Yes	Yes	Yes
tYP-n	Setpoint Boundary Type	Yes	Yes	Yes	No	Yes	No
Stb-n	Setpoint Standby Operation	Yes	Yes	Yes	No	Yes	No
HYS-n	Setpoint Hysteresis	No	Yes	No	No	No	No
tOFF-n	Setpoint Off Delay	No	Yes	No	No	No	No
tON-n	Setpoint On Delay	Yes	Yes	Yes	No	No	No
tOUT-n	Setpoint Time Out	Yes	No	No	Yes	No	No
RUL0-n	Totalizer Auto Reset	No	No	No	Yes	No	Yes
rSd-n	Reset With Display Reset	No	No	No	Yes	No	Yes
rSAS-n	Reset When Spn+1 Activates	No	No	No	Yes	No	Yes
rSRE-n	Reset When Spn+1 Deactivates	No	No	No	Yes	No	Yes

\* BOUNDARY is the only Setpoint Action available for setpoints assigned to Totalizer C.

### SETPOINT SELECT



Select a setpoint (alarm output) to open the remaining module menu. (The “n” in the following parameters will reflect the chosen setpoint number.) After the chosen setpoint is programmed, the display will default to **SPSEL NO**. Select the next setpoint to be programmed and continue the sequence for each setpoint. Pressing **PAR** at **SPSEL NO** will exit Module 6.

### SETPOINT ANNUNCIATORS



**OFF** disables the display of the setpoint annunciator. Normal (**NOr**) displays the corresponding setpoint annunciator of an “on” alarm output. Reverse (**rEU**) displays the corresponding setpoint annunciator of an “off” alarm output. **FLASH** flashes the display and the corresponding setpoint annunciator of an “on” alarm output.

### SETPOINT OUTPUT LOGIC



Normal (**NOr**) turns the output “on” when activated and “off” when deactivated. Reverse (**rEU**) turns the output “off” when activated and “on” when deactivated.

### SETPOINT ASSIGNMENT

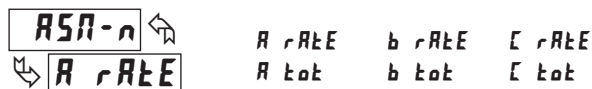

Select the display to which the setpoint is assigned.

### SETPOINT ACTION

↕  
 OFF    TOUT    BOUND    LATCH

**OFF:** When not using a setpoint, it should be set to **OFF** (no action).

#### For Rate Assignments:

Refer to diagrams "Setpoint (Alarm) Figures for Rate" on page 22.

- LATCH** With Latch action, the setpoint output activates when the rate value is equal to the setpoint value. The setpoint output remains active until reset. If after reset, the rate value is greater than or equal to (for **LYP = HI**) or less than or equal to (for **LYP = LO**) the setpoint value, the output will reactivate.
- BOUND** With Boundary action, the setpoint output activates when the rate value is greater than or equal to (for **LYP = HI**) or less than or equal to (for **LYP = LO**) the setpoint value. The setpoint output will deactivate (Auto reset) as determined by the hysteresis value.
- TOUT** With Timed Out action, the setpoint output cycles when the rate value is greater than or equal to (for **LYP = HI**) or less than or equal to (for **LYP = LO**) the setpoint value. The Setpoint Time Out (**TOUT-n**) and Setpoint On Delay (**SDO-n**) values determine the cycling times.

#### For Totalizer Assignments:

- LATCH** With Latch action, the setpoint output activates when the totalizer value equals the setpoint value. The output remains active until reset. This action is not associated with Boundary types.
- BOUND** With boundary action, the setpoint output activates when the totalizer value is greater than or equal to (for **LYP = HI**) or less than or equal to (for **LYP = LO**) the setpoint value. The setpoint output will deactivate when the totalizer value is less than (for **LYP = HI**) or greater than (for **LYP = LO**) the setpoint value. This is the only action available for setpoints assigned to Totalizer C.
- TOUT** With Timed Out action, the setpoint output activates when the totalizer value equals the setpoint value and deactivates after the Time Out value. This action is not associated with Boundary types.

### SETPOINT POWER UP STATE

↕  
 **SAVE**    **ON**    **OFF**

**SAVE** will restore the output to the same state it was at before the meter was powered down. **ON** will activate the output at power up. **OFF** will deactivate the output at power up.

### SETPOINT VALUE

↕  
 **-99999 to 999999**

Enter the desired setpoint value. Setpoint values can also be entered in the Quick Programming Mode when the setpoint is configured as **ENk** in Module 3. (Note: An Exchange Parameter Lists feature for setpoint values is explained in Module 2.)

### SETPOINT TRACKING

↕  
 **NO**    **SP-1**    **SP-2**    **SP-3**  
                  **SP-4**    **REnLd**    **bEnLd**

If a selection other than **NO** is chosen, then the value of the setpoint being programmed ("n") will track the entered selection's value. Tracking means that when the selection's value is changed (in the Quick Programming Mode), the "n" setpoint value will also change (or follow) by the same amount.

### SETPOINT BOUNDARY TYPE

↕  
 **HI**    **LO**

**HI** activates the output when the assigned display value (**RSn-n**) equals or exceeds the setpoint value. **LO** activates the output when the assigned display value is less than or equal to the setpoint.

### SETPOINT STANDBY OPERATION

↕  
 **YES**    **NO**

Selecting **YES** will disable low acting setpoints at power up until the assigned display value crosses into the output "off" area. Once in the output "off" area, the setpoint will function according to the configured setpoint parameters. This parameter only appears for low acting setpoints.

### SETPOINT HYSTERESIS

↕  
 **0 to 9999**

The hysteresis value is added to (for **LYP = LO**), or subtracted from (for **LYP = HI**), the setpoint value to determine at what value to deactivate the associated setpoint output. Hysteresis is only available for setpoints assigned to a Rate display with boundary action.

### SETPOINT OFF DELAY

↕  
 **000 to 9999 seconds**

This is the amount of time the assigned Rate display must meet the setpoint deactivation requirements (below hysteresis for high acting and above hysteresis for low acting) before the setpoint's output deactivates.

### SETPOINT ON DELAY

↕  
 **000 to 9999 seconds**

This is the amount of time the assigned Rate display must meet the setpoint activation requirements (below setpoint for **LYP = LO** and above setpoint for **LYP = HI**) before the setpoint's output activates. If the Rate Setpoint Action is Timed Out, this is the amount of time the output is off during the on/off output cycling.

### SETPOINT TIME OUT

↕  
 **000 to 9999 seconds**

If the setpoint action is Timed Out and the setpoint is assigned to Rate, then this is the amount of time the output is on during the on/off output cycling. If the setpoint action is Timed Out and the setpoint is assigned to Totalizer, then this is the amount of time the output will activate once the totalizer value equals the setpoint value.

### TOTALIZER AUTO RESET

**RTD-n** ↩  
 ↪ **NO**

**NO**    **ZEr-5t**    **CLd-5t**  
           **ZEr-En**    **CLd-En**

This parameter automatically resets the Setpoint Assigned Totalizer (A or B) each time the setpoint value is reached. The automatic reset can occur at output start (-5t) or output end (-En). The reset at output end selections will only appear if the Totalizer Setpoint Action is Timed Out. This reset may be different from the Totalizer Reset Action selected in Module 4.

SELECTION	ACTION
<b>NO</b>	No Auto Reset
<b>ZEr-5t</b>	Reset to Zero at the Start of output activation.
<b>CLd-5t</b>	Reset to Count Load Value at the Start of output activation
<b>ZEr-En</b>	Reset to Zero at the End of output activation (timed out only)
<b>CLd-En</b>	Reset to Count Load at the End of output activation (timed out only)

### SETPOINT RESET WITH DISPLAY RESET

**rSD-n** ↩  
 ↪ **NO**

**YES**    **NO**

Select **YES**, so the setpoint output will deactivate (reset) when the Setpoint Assignment (**ASn-n**) totalizer display resets. Note: The output will not reset if the assigned totalizer is reset by a setpoint generated Totalizer Auto reset.

### SETPOINT RESET WHEN SPn+1 ACTIVATES

**rSRS-n** ↩  
 ↪ **NO**

**YES**    **NO**

Select **YES**, so the setpoint output will deactivate (reset) when SPn +1 activates. (Example: SP1 deactivates when SP2 activates and SP4 when SP1 activates.) The last setpoint will wrap around to the first.

### SETPOINT RESET WHEN SPn+1 DEACTIVATES

**rSRE-n** ↩  
 ↪ **NO**

**YES**    **NO**

Select **YES**, so the setpoint output will deactivate (reset) when SPn +1 activates and then times out (deactivates). This function may only be used if the SPn+1 is programmed for Setpoint Action of **LOUT**. (Example SP1 deactivates when SP2 is activated and then times out.) The last setpoint will wrap around to the first.

## SETPOINT (ALARM) FIGURES FOR RATE

(For Reverse Action, The Alarm state is opposite.)

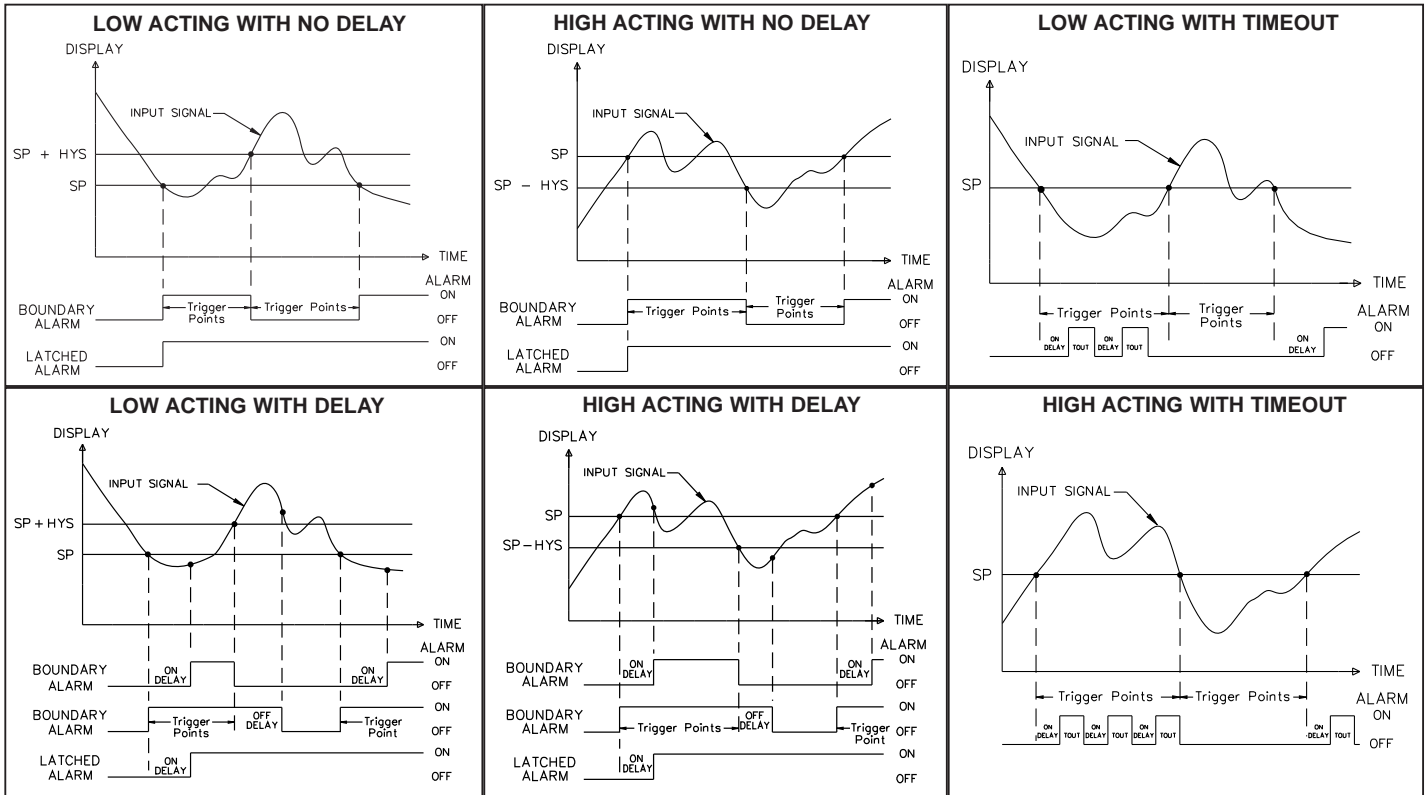

# 6.7 MODULE 7 - SERIAL COMMUNICATIONS PARAMETERS (7-5rL)

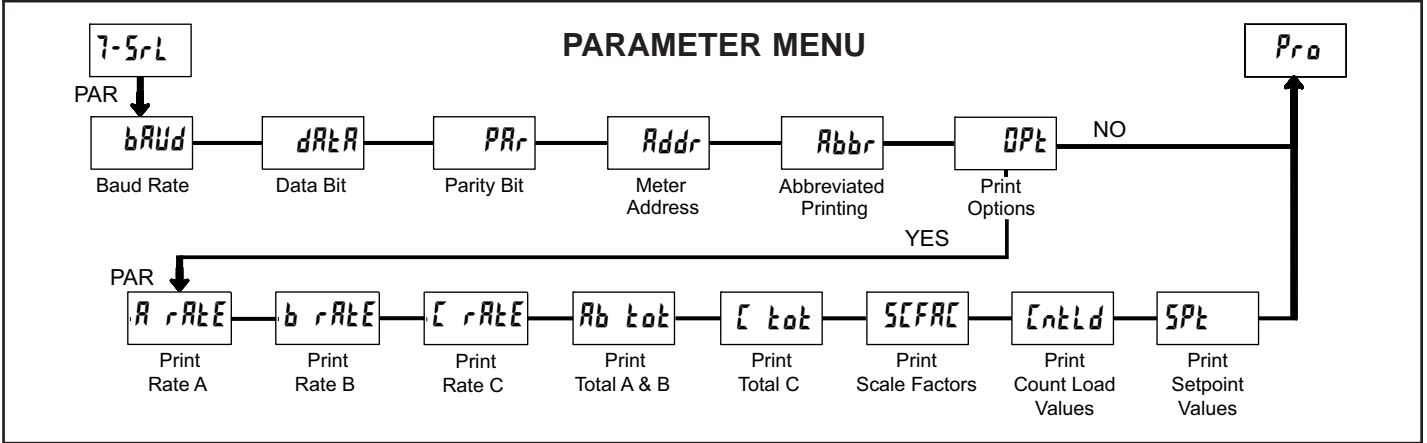

Module 7 is the programming module for the Serial Communications Parameters. These parameters are used to match the serial settings of the meter with those of the host computer or other serial device, such as a terminal or printer. This programming module can only be accessed if an RS232 or RS485 Serial Communications card is installed.

This section also includes an explanation of the commands and formatting required for communicating with the PAXDR. In order to establish serial communications, the user must have host software that can send and receive ASCII characters.

*This section does NOT apply to the DeviceNet, Modbus, or Profibus-DP communication cards. For details on the operation of the Fieldbus cards, refer to the bulletin shipped with each card.*

## ABBREVIATED PRINTING



Select **NO** for full print or Command T transmissions (meter address, parameter data and mnemonics) or **YES** for abbreviated print transmissions (parameter data only). This will affect all the parameters selected in the print options. (If the meter address is 00, it will not be sent during a full transmission.)

## PRINT OPTIONS



**YES** - Enters the sub-menu to select the meter parameters to appear during a print request. For each parameter in the sub-menu, select **YES** for that parameter information to be sent during a print request or **NO** for that parameter information not to be sent. A print request is sometimes referred to as a block print because more than one parameter's information (meter address, parameter data and mnemonics) can be sent to a printer or computer as a block.

## BAUD RATE

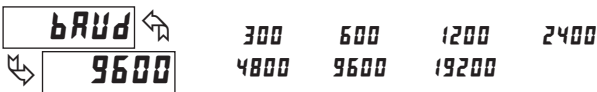

Set the baud rate to match the other serial communications equipment on the serial link. Normally, the baud rate is set to the highest value that all the serial equipment are capable of transmitting and receiving.

## DATA BIT



Select either 7 or 8 bit data word lengths. Set the word length to match the other serial communications equipment on the serial link.

## PARITY BIT



Set the parity bit to match that of the other serial communications equipment on the serial link. The meter ignores the parity when receiving data and sets the parity bit for outgoing data. If no parity is selected with 7 bit word length, an additional stop bit is used to force the frame size to 10 bits.

## METER ADDRESS



Enter the serial meter (node) address. With a single unit, an address is not needed and a value of zero can be used. With multiple units (RS485 applications), a unique 2 digit address number must be assigned to each meter.

PARAMETER	DESCRIPTION	FACTORY	MNEMONIC
A rAtE	Rate A	YES	RTA
b rAtE	Rate B	YES	RTB
C rAtE	Rate C	NO	RTC
Ab tot	Total A & B	NO	TOA TOB
C tot	Total C	NO	TOC
SCFAC	A B C Scale Factors	NO	SFA SFB SFC
CntLd	A B Count Load	NO	LDA LDB
SPt	1 2 3 4 Setpoints *	NO	SP1 SP2 SP3 SP4

\*Setpoints are plug-in card dependent.

## SENDING SERIAL COMMANDS AND DATA

When sending commands to the meter, a string containing at least one command character must be constructed. A command string consists of a command character, a value identifier, numerical data (if writing data to the meter) followed by a command terminator character \* or \$.

### Command Chart

Command	Description	Notes
N	Node (Meter) Address Specifier	Address a specific meter. Must be followed by <b>two digit</b> node address. Not required when address = 00.
T	Transmit Value (read)	Read a register from the meter. Must be followed by register ID character.
V	Value change (write)	Write to register of the meter. Must be followed by register ID character and numeric data.
R	Reset	Reset a register or output. Must be followed by register ID character
P	Block Print Request (read)	Initiates a block print output. Registers are defined in programming.

### Command String Construction

The command string must be constructed in a specific sequence. The meter does not respond with an error message to invalid commands. The following procedure details construction of a command string:

1. The first characters consist of the Node Address Specifier (N) followed by a 2 character address number. The address number of the meter is programmable. If the node address is 0, this command and the node address itself may be omitted. This is the only command that may be used in conjunction with other commands.
2. After the optional address specifier, the next character is the command character.
3. The next character is the Register ID. This identifies the register that the command affects. The P command does not require a Register ID character. It prints according to the selections made in print options.
4. If constructing a value change command (writing data), the numeric data is sent next.
5. All command strings must be terminated with the string termination characters \* or \$. The meter does not begin processing the command string until this character is received. See Timing Diagram figure for differences between terminating characters.

### Register Identification Chart

ID	VALUE DESCRIPTION	REGISTER NAME <sup>1</sup>	COMMAND <sup>2</sup>	TRANSMIT DETAILS <sup>3</sup>
A	Rate A	RTA	T	5 digit, positive only
B	Rate B	RTB	T	5 digit, positive only
C	Rate C	RTC	T	4 negative, 5 positive
D	Total A	TOA	T, V, R	6 digit (V), 8 digit (T)
E	Total B	TOB	T, V, R	6 digit (V), 8 digit (T)
F	Total C	TOC	T, R	8 digit
G	Scale Factor A	SFA	T, V	6 digit, positive only
H	Scale Factor B	SFB	T, V	6 digit, positive only
I	Scale Factor C	SFC	T, V	6 digit, positive only
J	Count Load A	LDA	T, V	5 negative, 6 positive
K	Count Load B	LDB	T, V	5 negative, 6 positive
M	Setpoint 1	SP1	T, V, R	5 negative, 6 positive
O	Setpoint 2	SP2	T, V, R	5 negative, 6 positive
Q	Setpoint 3	SP3	T, V, R	5 negative, 6 positive
S	Setpoint 4	SP4	T, V, R	5 negative, 6 positive
U	Auto/Manual Register	MMR	T, V	0 - auto, 1 - manual
W	Analog Output Register	AOR	T, V	0 - 4095 normalized
X	Setpoint Register	SOR	T, V	0 - not active, 1 - active

1. Register Names are also used as Register Mnemonics during full transmission.
2. The registers associated with the P command are set up in Print Options (Module 7).
3. Unless otherwise specified, the Transmit Details apply to both T and V Commands.

### Command String Examples:

1. Address = 17, Write 350 to Setpoint 1  
String: N17VM350\$
2. Address = 5, Read Rate A value, response time of 50 - 100 msec. min.  
String: N05TA\*
3. Address = 0, Reset Setpoint 4 output  
String: RS\*

### Transmitting Data To the Meter

Numeric data sent to the meter must be limited to Transmit Details listed in the Register Identification Chart. Leading zeros are ignored. Negative numbers must have a minus sign. The meter ignores any decimal point and conforms the number to the scaled resolution. (ie. The meter's scaled decimal point position is set for 0.0 and 25 is written to a register. The value of the register is now 2.5. In this case, write a value of 250 to equal 25.0).

*Note: Since the meter does not issue a reply to value change commands, follow with a transmit value command for readback verification.*

### Transmitting Data From the Meter

Data is transmitted from the meter in response to either a transmit command (T), a print block command (P) or User Function print request. The response from the meter is either a full field transmission or an abbreviated transmission. The meter response is established in Module 7.

### Full Transmission

Byte	Description
1, 2	2 byte Node (Meter) Address field [00-99]
3	<SP> (Space)
4-6	3 byte Register Mnemonic field
7-18	12 byte numeric data field: 10 bytes for number, one byte for sign, one byte for decimal point
19	<CR> (Carriage return)
20	<LF> (Line feed)
21	<SP> (Space)*
22	<CR> (Carriage return)*
23	<LF> (Line feed)*

\* These characters only appear in the last line of a block print.

The first two characters transmitted (bytes 1 and 2) are the unit address. If the address assigned is 00, two spaces are substituted. A space (byte 3) follows the unit address field. The next three characters (bytes 4 to 6) are the register mnemonic. The numeric data is transmitted next.

The numeric field (bytes 7 to 18) is 12 characters long. When the requested value exceeds eight digits for total values or five digits for rate values, an \* (used as an overflow character) replaces the space in byte 7. Byte 8 is always a space. The remaining ten positions of this field (bytes 9 to 18) consist of a minus sign (for negative values), a floating decimal point (if applicable), and eight positions for the requested value. The data within bytes 9 to 18 is right-aligned with leading spaces for any unfilled positions.

The end of the response string is terminated with <CR> (byte 19), and <LF> (byte 20). When a block print is finished, an extra <SP> (byte 21), <CR> (byte 22), and <LF> (byte 23) are used to provide separation between the transmissions.

### Abbreviated Transmission

Byte	Description
1-12	12 byte data field, 10 bytes for number, one byte for sign, one byte for decimal point
13	<CR> (Carriage return)
14	<LF> (Line feed)
15	<SP> (Space)*
16	<CR> (Carriage return)*
17	<LF> (Line feed)*

\* These characters only appear in the last line of a block print.

The abbreviated response suppresses the address and register mnemonics, leaving only the numeric part of the response.

### Meter Response Examples:

1. Address = 17, full field response, Rate A = 875  
17 RTA 875 <CR><LF>
2. Address = 0, full field response, Setpoint 2 = -250.5  
SP2 -250.5<CR><LF>
3. Address = 0, abbreviated response, Setpoint 2 = 250, last line of block print  
250<CR><LF><SP><CR><LF>

### Auto/Manual Mode Register (MMR) ID: U

This register sets the controlling mode for the outputs. In Auto Mode (0) the meter controls the setpoint and analog output. In Manual Mode (1) the outputs are defined by the registers SOR and AOR. When transferring from auto mode to manual mode, the meter holds the last output value (until the register is changed by a write). Each output may be independently changed to auto or manual. In a write command string (VU), any character besides 0 or 1 in a field will not change the corresponding output mode.

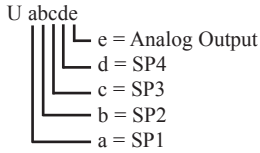

**Example:** Address = 0, place SP4 and Analog in manual mode  
String: VU00011\*

### Analog Output Register (AOR) ID: W

This register stores the present signal value of the analog output. The range of values of this register is 0 to 4095, which corresponds to the analog output range per the following chart:

Register Value	Output Signal*		
	0-20 mA	4-20 mA	0-10V
0	0.000	4.000	0.000
1	0.005	4.004	0.0025
2047	10.000	12.000	5.000
4094	19.995	19.996	9.9975
4095	20.000	20.000	10.000

*\*Due to the absolute accuracy rating and resolution of the output card, the actual output signal may differ 0.15% FS from the table values. The output signal corresponds to the range selected (0-20 mA, 4-20 mA or 0-10 V).*

Writing to this register (VW) while the analog output is in the Manual Mode causes the output signal level to update immediately to the value sent. While in the Automatic Mode, this register may be written to, but it has no effect until the analog output is placed in the manual mode. When in the Automatic Mode, the meter controls the analog output signal level. Reading from this register (TW) will show the present value of the analog output signal.

**Example:** Address = 0, Analog output previously programmed for Manual Mode  
String: VW2047\* will result in an output of 10.000 mA, 12.000 mA or 5.000 V depending on the range selected.

### Setpoint Output Register (SOR) ID: X

This register stores the states of the setpoint outputs. Reading from this register (TX) will show the present state of all the setpoint outputs. A "0" in the setpoint location means the output is off and a "1" means the output is on.

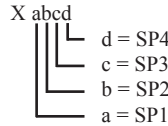

In Automatic Mode, the meter controls the setpoint output state. In Manual Mode, writing to this register (VX) will change the output state. Sending any character besides 0 or 1 in a field or if the corresponding output was not first in manual mode, the corresponding output value will not change. (It is not necessary to send least significant 0s.)

**Example:** Address = 0, SP1 and SP2 previously programmed for Manual Mode  
String: VX10\* will result in output 1 on and output 2 off.

## COMMAND RESPONSE TIME

The meter can only receive data or transmit data at any one time (half-duplex operation). During RS232 transmissions, the meter ignores commands while transmitting data, but instead uses RXD as a busy signal. When sending commands and data to the meter, a delay must be imposed before sending another command. This allows enough time for the meter to process the command and prepare for the next command.

At the start of the time interval  $t_1$ , the computer program prints or writes the string to the com port, thus initiating a transmission. During  $t_1$ , the command characters are under transmission and at the end of this period, the command terminating character (\* or \$) is received by the meter. The time duration of  $t_1$  is dependent on the number of characters and baud rate of the channel.

$$t_1 = (10 \text{ times the \# of characters}) / \text{baud rate}$$

At the start of time interval  $t_2$ , the meter starts the interpretation of the command and when complete, performs the command function. This time interval  $t_2$  varies (See Timing Diagrams). If no response from the meter is expected, the meter is ready to accept another command.

If the meter is to reply with data, the time interval  $t_2$  is controlled by the use of the command terminating character. The "\*" terminating character results in a response time window of 50 msec. minimum and 100 msec. maximum. This allows sufficient time for the release of the sending driver on the RS485 bus. Terminating the command line with "\$" results in a response time window ( $t_2$ ) of 2 msec. minimum and 50 msec. maximum. The faster response time of this terminating character requires that sending drivers release within 2 msec. after the terminating character is received.

At the beginning of time interval  $t_3$ , the meter responds with the first character of the reply. As with  $t_1$ , the time duration of  $t_3$  is dependent on the number of characters and baud rate of the channel. At the end of  $t_3$ , the meter is ready to receive the next command.

$$t_3 = (10 \text{ times the \# of characters}) / \text{baud rate}$$

The maximum serial throughput of the meter is limited to the sum of the times  $t_1$ ,  $t_2$  and  $t_3$ .

## SERIAL TIMING

COMMAND	COMMENT	PROCESS TIME ( $t_2$ )
R	Reset	2-50 msec.
V	Write	100-200 msec.
T	Transmit	2-50 msec. for \$ 50-100 msec. for *
P	Print	2-50 msec. for \$ 50-100 msec. for *

### Timing Diagrams

#### NO REPLY FROM METER

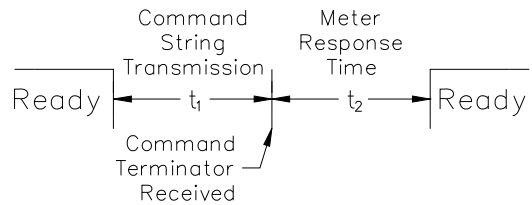

#### RESPONSE FROM METER

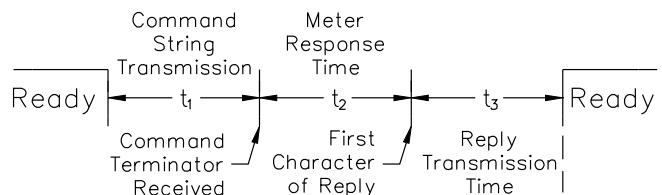



## COMMUNICATION FORMAT

Data is transferred from the meter through a serial communication channel. In serial communications, the voltage is switched between a high and low level at a predetermined rate (baud rate) using ASCII encoding. The receiving device reads the voltage levels at the same intervals and then translates the switched levels back to a character.

The voltage level conventions depend on the interface standard. The table lists the voltage levels for each standard.

LOGIC	INTERFACE STATE	RS232*	RS485*
1	mark (idle)	TXD,RXD; -3 to -15 V	a-b < -200 mV
0	space (active)	TXD,RXD; +3 to +15 V	a-b > +200 mV

\* Voltage levels at the Receiver

Data is transmitted one byte at a time with a variable idle period between characters (0 to ∞). Each ASCII character is “framed” with a beginning start bit, an optional parity bit and one or more ending stop bits. The data format and baud rate must match that of other equipment in order for communication to take place. The figures list the data formats employed by the meter.

### Start bit and Data bits

Data transmission always begins with the start bit. The start bit signals the receiving device to prepare for reception of data. One bit period later, the least significant bit of the ASCII encoded character is transmitted, followed by the remaining data bits. The receiving device then reads each bit position as they are transmitted.

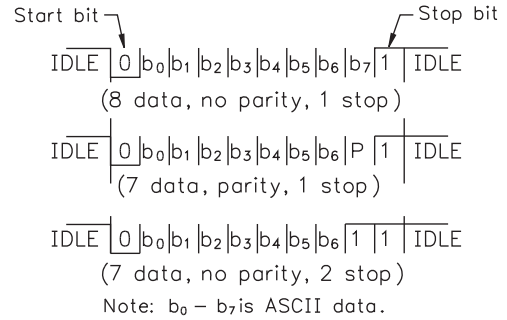

Character Frame Figure

### Parity bit

After the data bits, the parity bit is sent. The transmitter sets the parity bit to a zero or a one, so that the total number of ones contained in the transmission (including the parity bit) is either even or odd. This bit is used by the receiver to detect errors that may occur to an odd number of bits in the transmission. However, a single parity bit cannot detect errors that may occur to an even number of bits. Given this limitation, the parity bit is often ignored by the receiving device. The PAX meter ignores the parity bit of incoming data and sets the parity bit to odd, even or none (mark parity) for outgoing data.

### Stop bit

The last character transmitted is the stop bit. The stop bit provides a single bit period pause to allow the receiver to prepare to re-synchronize to the start of a new transmission (start bit of next byte). The receiver then continuously looks for the occurrence of the start bit. If 7 data bits and no parity is selected, then 2 stop bits are sent from the PAX meter.

## 6.8 MODULE 8 - ANALOG OUTPUT PARAMETERS (B-RnR)

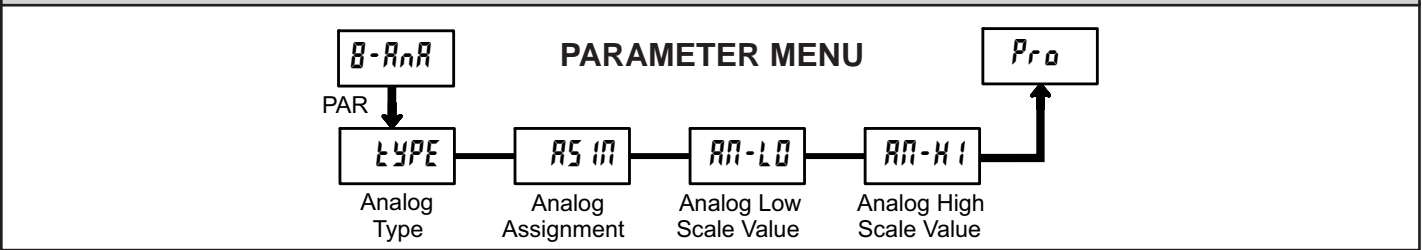

Module 8 is the programming for the analog output parameters. To have an analog output signal, an analog output plug-in card needs to be installed (See Ordering Information).

### ANALOG TYPE

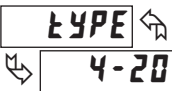

SELECTION	RANGE
0-20	0 to 20 mA
4-20	4 to 20 mA
0-10	0 to 10 V

Enter the analog output type. For voltage output use terminals 16 and 17. For current output use terminals 18 and 19. Only one range can be used at a time.

### ANALOG ASSIGNMENT



A rRtE	b rRtE	C rRtE
A tot	b tot	C tot

Select the display that the analog output is to follow:

A rRtE = Rate A Value	A tot = Totalizer A Value
b rRtE = Rate B Value	b tot = Totalizer B Value
C rRtE = Rate C Value	C tot = Totalizer C Value

### ANALOG LOW SCALE VALUE



-99999 to 999999

Enter the display value within the selected Analog Assignment that corresponds to the low limit of the type selected.

The decimal point is determined by the decimal point setting of the assigned totalizer or rate. The scale value can not be set to read values with more than 6 digits. Reverse acting output is possible by reversing the scaling values.

### ANALOG HIGH SCALE VALUE



-99999 to 999999

Enter the display value within the selected Analog Assignment that corresponds to the high limit of the type selected.

The decimal point is determined by the decimal point setting of the assigned totalizer or rate. The scale value can not be set to read values with more than 6 digits. Reverse acting output is possible by reversing the scaling values.

# 6.9 MODULE 9 - FACTORY SERVICE OPERATIONS (9-FCS)



## DISPLAY INTENSITY LEVEL

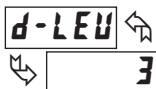

Enter the desired Display Intensity Level (0-15) by using the arrow keys. The display will actively dim or brighten as the levels are changed. This parameter also appears in Quick Programming Mode when enabled.

## RESTORE FACTORY DEFAULTS

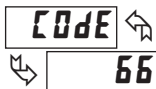

Use the arrow keys to display **CODE 66** and press **PAR**. The meter will display **rESEt** and then return to **CODE 50**. Press **DSP** key to return to the Display Mode. This will overwrite all user settings with the factory settings.

Pressing the **PAR** and **DSP** keys at the same time on power-up will load the factory settings and display **Err4**. This allows operation in the event of a memory failure or corrupted data. Immediately press **RST** key and reprogram the meter. If the meter is powered down again before pressing the **RST** key, the existing dynamic data will not be overwritten.

## CALIBRATION

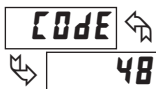

The only item in the PAXDR meter that can be calibrated is the Analog Output. If the meter appears to be indicating incorrectly or inaccurately, refer to the Troubleshooting section.

When Analog Out recalibration is required (generally every 2 years), it should be performed by qualified technicians using appropriate equipment. Calibration does not change any user programmed parameters.

Calibration may be aborted by disconnecting power to the meter before exiting Module 9. In this case, the existing calibration settings remain in effect.

*Note: Allow a 30 minute warm-up period before starting calibration.*

## Analog Output Card Calibration

Before starting, verify that a precision meter with an accuracy of 0.05% or better (voltmeter for voltage output and/or current meter for current output) is connected and ready. Then perform the following procedure:

1. Use the arrow keys to display **CODE 48** and press **PAR**.
2. **ANALOut** is displayed. Use the arrow keys to select **YES** and press **PAR**.
3. Using the chart below, step through the five selections to be calibrated. At each prompt, use the PAXDR arrow keys to adjust the output so that the external meter display matches the selection being calibrated. When the external reading matches, or if the range is not being calibrated, press **PAR**.

SELECTION	EXTERNAL METER	ACTION
0.0 A	0.00	Adjust if necessary, press <b>PAR</b>
4.0 A	4.00	Adjust if necessary, press <b>PAR</b>
20.0 A	20.00	Adjust if necessary, press <b>PAR</b>
0.0 u	0.00	Adjust if necessary, press <b>PAR</b>
10.0 u	10.00	Adjust if necessary, press <b>PAR</b>

4. When **Code 50** appears, press **PAR** twice and remove the external meters.

# TROUBLESHOOTING

For further assistance, contact technical support at the appropriate company numbers listed.

PROBLEM	REMEDIES
NO DISPLAY	<b>CHECK:</b> Power level, power connections
PROGRAM LOCKED-OUT	<b>CHECK:</b> Active (lock-out) user input <b>ENTER:</b> Security code requested
CERTAIN DISPLAYS ARE LOCKED OUT	<b>CHECK:</b> Module 3 programming
INCORRECT DISPLAY VALUE or NOT COUNTING	<b>CHECK:</b> Input wiring, DIP switch setting, input programming, scale factor calculation, input signal level, user input jumper, lower input signal frequency
USER INPUT NOT WORKING CORRECTLY	<b>CHECK:</b> User input wiring, user input jumper, user input being used for signal, Module 2
OUTPUT DOES NOT WORK	<b>CHECK:</b> Corresponding plug-in card installation, output configuration, output wiring
JITTERY DISPLAY	<b>CHECK:</b> Wiring is per EMC installation guidelines, input signal frequency, signal quality, scaling, update time, DIP switch setting
"0L0L" DISPLAYED	<b>CHECK:</b> Lower input signal frequency, reduce scaling values (display capacity exceeded). Divide by 0 condition exists for Display C calculation.
MODULES or PARAMETERS NOT ACCESSIBLE	<b>CHECK:</b> Corresponding plug-in card installation, related controlling parameter selected
ERROR CODE (Err 1-4)	<b>PRESS:</b> Reset key (if unable to clear contact factory.)
SERIAL COMMUNICATIONS	<b>CHECK:</b> Wiring, connections, meter and host settings

# PARAMETER VALUE CHART

## PAXDR Model Number \_\_\_\_\_

Programmer \_\_\_\_\_ Date \_\_\_\_\_  
 Meter# \_\_\_\_\_ Security Code \_\_\_\_\_

### 1 - RATE Rate Setup Parameters

DISPLAY	PARAMETER	FACTORY SETTING	USER SETTING
L0-udt	LOW UPDATE TIME	10	_____
H1-udt	HIGH UPDATE TIME	20	_____
C rAEE	RATE C CALCULATION	none	_____
C SCLr	RATE C DISPLAY MULTIPLIER**	1	_____
C dPt	RATE C DECIMAL POSITION**	0	_____
C LI	RATE C DISPLAY INDICATOR**	0n	_____
Ab dPt	RATE A & B DECIMAL POSITION**	0	_____
A dPt	RATE A DECIMAL POSITION***	0	_____
A SE65	RATE A LINEARIZER SEGMENTS	0	_____
A dSP 0	A SCALING PT 1 - DISPLAY VALUE	0	_____
A INP 0	A SCALING PT 1 - INPUT VALUE	0.0	_____
A dSP 1	A SCALING PT 2 - DISPLAY VALUE	1000	_____
A INP 1	A SCALING PT 2 - INPUT VALUE	1000.0	_____
A dSP 2	A SCALING PT 3 - DISPLAY VALUE	2000	_____
A INP 2	A SCALING PT 3 - INPUT VALUE	2000.0	_____
A dSP 3	A SCALING PT 4 - DISPLAY VALUE	3000	_____
A INP 3	A SCALING PT 4 - INPUT VALUE	3000.0	_____
A dSP 4	A SCALING PT 5 - DISPLAY VALUE	4000	_____
A INP 4	A SCALING PT 5 - INPUT VALUE	4000.0	_____
A dSP 5	A SCALING PT 6 - DISPLAY VALUE	5000	_____
A INP 5	A SCALING PT 6 - INPUT VALUE	5000.0	_____
A dSP 6	A SCALING PT 7 - DISPLAY VALUE	6000	_____
A INP 6	A SCALING PT 7 - INPUT VALUE	6000.0	_____
A dSP 7	A SCALING PT 8 - DISPLAY VALUE	7000	_____
A INP 7	A SCALING PT 8 - INPUT VALUE	7000.0	_____
A dSP 8	A SCALING PT 9 - DISPLAY VALUE	8000	_____
A INP 8	A SCALING PT 9 - INPUT VALUE	8000.0	_____
A dSP 9	A SCALING PT 10 - DISPLAY VALUE	9000	_____
A INP 9	A SCALING PT 10 - INPUT VALUE	9000.0	_____
A rnd	RATE A DISPLAY ROUNDING	1	_____
b dPt	RATE B DECIMAL POSITION***	0	_____
b SE65	RATE B LINEARIZER SEGMENTS	0	_____
b dSP 0	B SCALING PT 1 - DISPLAY VALUE	0	_____
b INP 0	B SCALING PT 1 - INPUT VALUE	0.0	_____
b dSP 1	B SCALING PT 2 - DISPLAY VALUE	1000	_____
b INP 1	B SCALING PT 2 - INPUT VALUE	1000.0	_____
b dSP 2	B SCALING PT 3 - DISPLAY VALUE	2000	_____
b INP 2	B SCALING PT 3 - INPUT VALUE	2000.0	_____
b dSP 3	B SCALING PT 4 - DISPLAY VALUE	3000	_____
b INP 3	B SCALING PT 4 - INPUT VALUE	3000.0	_____
b dSP 4	B SCALING PT 5 - DISPLAY VALUE	4000	_____
b INP 4	B SCALING PT 5 - INPUT VALUE	4000.0	_____
b dSP 5	B SCALING PT 6 - DISPLAY VALUE	5000	_____
b INP 5	B SCALING PT 6 - INPUT VALUE	5000.0	_____
b dSP 6	B SCALING PT 7 - DISPLAY VALUE	6000	_____
b INP 6	B SCALING PT 7 - INPUT VALUE	6000.0	_____
b dSP 7	B SCALING PT 8 - DISPLAY VALUE	7000	_____
b INP 7	B SCALING PT 8 - INPUT VALUE	7000.0	_____
b dSP 8	B SCALING PT 9 - DISPLAY VALUE	8000	_____
b INP 8	B SCALING PT 9 - INPUT VALUE	8000.0	_____
b dSP 9	B SCALING PT 10 - DISPLAY VALUE	9000	_____
b INP 9	B SCALING PT 10 - INPUT VALUE	9000.0	_____
b rnd	RATE B DISPLAY ROUNDING	1	_____

\*\* Parameter only appears when RATE C is enabled.  
 \*\*\* Parameter only appears when RATE C is disabled.

### 2 - FNC User Input and Function Key Parameters

DISPLAY	PARAMETER	FACTORY SETTING	USER SETTING
U5r-1	USER INPUT 1	no	_____
U5r-2	USER INPUT 2	no	_____
U5r-3	USER INPUT 3	no	_____
F1	FUNCTION KEY 1	no	_____
F2	FUNCTION KEY 2	no	_____
r5t	RESET KEY	no	_____
5C-F1	SECOND FUNCTION KEY 1	no	_____
5C-F2	SECOND FUNCTION KEY 2	no	_____

### 3 - LCK Display and Program Lock-out Parameters

DISPLAY	PARAMETER	FACTORY SETTING	USER SETTING
A rAEE	RATE A DISPLAY LOCK-OUT	rEd	_____
b rAEE	RATE B DISPLAY LOCK-OUT	rEd	_____
C rAEE	RATE C DISPLAY LOCK-OUT	rEd	_____
A tAEE	TOTALIZER A DISPLAY LOCK-OUT	L0C	_____
b tAEE	TOTALIZER B DISPLAY LOCK-OUT	L0C	_____
C tAEE	TOTALIZER C DISPLAY LOCK-OUT	L0C	_____
SP-1	SETPOINT 1 ACCESS LOCK-OUT	L0C	_____
SP-2	SETPOINT 2 ACCESS LOCK-OUT	L0C	_____
SP-3	SETPOINT 3 ACCESS LOCK-OUT	L0C	_____
SP-4	SETPOINT 4 ACCESS LOCK-OUT	L0C	_____
A nELd	TOTALIZER A COUNT LOAD ACCESS	L0C	_____
b nELd	TOTALIZER B COUNT LOAD ACCESS	L0C	_____
A SCFAE	TOTAL A SCALE FACTOR ACCESS	L0C	_____
b SCFAE	TOTAL B SCALE FACTOR ACCESS	L0C	_____
C SCFAE	TOTAL C SCALE FACTOR ACCESS	L0C	_____
C0dE	SECURITY CODE	0	_____

### 4 - tAEE Totalizer A and B Setup Parameters

DISPLAY	PARAMETER	FACTORY SETTING	USER SETTING
A tAEE	TOTALIZER A OPERATING MODE	none	_____
A rESEt	TOTALIZER A RESET ACTION	ZEro	_____
A dECPt	TOTALIZER A DECIMAL POSITION	0	_____
A SCFAE	TOTALIZER A SCALE FACTOR (A)	100000	_____
	TOTALIZER A SCALE FACTOR (B)*	100000	_____
A SCALr	TOTALIZER A SCALE MULTIPLIER	1	_____
A nELd	TOTALIZER A COUNT LOAD (A)	500	_____
	TOTALIZER A COUNT LOAD (B)*	500	_____
A P-UP	TOTALIZER A RESET AT POWER-UP	no	_____
b tAEE	TOTALIZER B OPERATING MODE	none	_____
b rESEt	TOTALIZER B RESET ACTION	ZEro	_____
b dECPt****	TOTALIZER B DECIMAL POSITION	0	_____
b SCFAE	TOTALIZER B SCALE FACTOR (A)	100000	_____
	TOTALIZER B SCALE FACTOR (B)*	100000	_____
b SCALr	TOTALIZER B SCALE MULTIPLIER	1	_____
b nELd	TOTALIZER B COUNT LOAD (A)	500	_____
	TOTALIZER B COUNT LOAD (B)*	500	_____
b P-UP	TOTALIZER B RESET AT POWER-UP	no	_____

\* See Module 2, Exchanging Parameter Lists, for details on programming this value.  
 \*\*\*\* Parameter only appears when Totalizer C is disabled.

## 5-Totalizer C Setup Parameters

DISPLAY	PARAMETER	FACTORY SETTING	USER SETTING
CTOTAL	TOTALIZER C CALCULATION	NO	_____
DECPOS	TOTALIZER C DECIMAL POSITION	0	_____
SCALE	TOTALIZER C SCALE FACTOR (A)	100000	_____
SCALEB	TOTALIZER C SCALE FACTOR (B)*	100000	_____
SCALEM	TOTALIZER C SCALE MULTIPLIER	1	_____
RESET	TOTALIZER C RESET AT POWER-UP	NO	_____

\* See Module 2, Exchanging Parameter Lists, for details on programming this value.

## 7-Serial Communications Parameters

DISPLAY	PARAMETER	FACTORY SETTING	USER SETTING
BAUD	BAUD RATE	9600	_____
DATA	DATA BIT	7	_____
PAR	PARITY BIT	Odd	_____
ADDR	METER ADDRESS	0	_____
ABBR	ABBREVIATED PRINTING	NO	_____
RA	PRINT RATE A	YES	_____
RB	PRINT RATE B	YES	_____
RC	PRINT RATE C	NO	_____
RA&B	PRINT TOTAL A & B	NO	_____
RTOTAL	PRINT TOTAL C	NO	_____
SCALE	PRINT SCALE FACTORS	NO	_____
COUNT	PRINT COUNT LOAD VALUES	NO	_____
SET	PRINT SETPOINT VALUES	NO	_____

## 8-Analog Output Parameters

DISPLAY	PARAMETER	FACTORY SETTING	USER SETTING
ATYPE	ANALOG TYPE	4-20	_____
ASIGN	ANALOG ASSIGNMENT	RA	_____
AN-L	ANALOG LOW SCALE VALUE	0	_____
AN-H	ANALOG HIGH SCALE VALUE	1000	_____

## 9-Factory Service Parameters

DISPLAY	PARAMETER	FACTORY SETTING	USER SETTING
DL	DISPLAY INTENSITY LEVEL	3	_____

## 6-Setpoint (Alarm) Parameters

DISPLAY	PARAMETER	SP-1		SP-2		SP-3		SP-4	
		FACTORY SETTING	USER SETTING	FACTORY SETTING	USER SETTING	FACTORY SETTING	USER SETTING	FACTORY SETTING	USER SETTING
OUT	SETPOINT OUTPUT LOGIC	NO	_____	NO	_____	NO	_____	NO	_____
ANN	SETPOINT ANNUNCIATORS	NO	_____	NO	_____	NO	_____	NO	_____
ASIGN	SETPOINT ASSIGNMENT	RA	_____	RA	_____	RA	_____	RA	_____
ACTION	SETPOINT ACTION	OFF	_____	OFF	_____	OFF	_____	OFF	_____
POWER	SETPOINT POWER-UP STATE	OFF	_____	OFF	_____	OFF	_____	OFF	_____
VAL	SETPOINT VALUE (A)	100	_____	100	_____	100	_____	100	_____
VALB	SETPOINT VALUE (B)*	100	_____	100	_____	100	_____	100	_____
TRK	SETPOINT TRACKING	NO	_____	NO	_____	NO	_____	NO	_____
BOUND	SETPOINT BOUNDARY TYPE	H	_____	H	_____	H	_____	H	_____
STANDBY	STANDBY OPERATION	NO	_____	NO	_____	NO	_____	NO	_____
HYST	SETPOINT HYSTERESIS	0	_____	0	_____	0	_____	0	_____
OFF	SETPOINT OFF DELAY	0.00	_____	0.00	_____	0.00	_____	0.00	_____
ON	SETPOINT ON DELAY	0.00	_____	0.00	_____	0.00	_____	0.00	_____
TIME	SETPOINT TIME OUT	100	_____	100	_____	100	_____	100	_____
AUTO	TOTALIZER AUTO RESET	NO	_____	NO	_____	NO	_____	NO	_____
RESET	SETPOINT RESET WITH DISPLAY	NO	_____	NO	_____	NO	_____	NO	_____
ACT	RESET WHEN SPn+1 ACTIVATES	NO	_____	NO	_____	NO	_____	NO	_____
DEACT	RESET WHEN SPn+1 DEACTIVATES	NO	_____	NO	_____	NO	_____	NO	_____

\* See Module 2, Exchanging Parameter Lists, for details on programming this value.

**This page intentionally left blank.**

**This page intentionally left blank.**



#### **LIMITED WARRANTY**

The Company warrants the products it manufactures against defects in materials and workmanship for a period limited to two years from the date of shipment, provided the products have been stored, handled, installed, and used under proper conditions. The Company's liability under this limited warranty shall extend only to the repair or replacement of a defective product, at The Company's option. The Company disclaims all liability for any affirmation, promise or representation with respect to the products.

The customer agrees to hold Red Lion Controls harmless from, defend, and indemnify RLC against damages, claims, and expenses arising out of subsequent sales of RLC products or products containing components manufactured by RLC and based upon personal injuries, deaths, property damage, lost profits, and other matters which Buyer, its employees, or sub-contractors are or may be to any extent liable, including without limitation penalties imposed by the Consumer Product Safety Act (P.L. 92-573) and liability imposed upon any person pursuant to the Magnuson-Moss Warranty Act (P.L. 93-637), as now in effect or as amended hereafter.

No warranties expressed or implied are created with respect to The Company's products except those expressly contained herein. The Customer acknowledges the disclaimers and limitations contained herein and relies on no other warranties or affirmations.

Red Lion Controls  
Headquarters  
20 Willow Springs Circle  
York PA 17406  
Tel +1 (717) 767-6511  
Fax +1 (717) 764-0839

Red Lion Controls  
Europe  
Softwareweg 9  
NL - 3821 BN Amersfoort  
Tel +31 (0) 334 723 225  
Fax +31 (0) 334 893 793

Red Lion Controls  
India  
201-B, 2nd Floor, Park Centra  
Opp 32 Mile Stone, Sector-30  
Gurgaon-122002 Haryana, India  
Tel +91 984 487 0503

Red Lion Controls  
China  
Unit 101, XinAn Plaza  
Building 13, No.99 Tianzhou Road  
ShangHai, P.R. China 200223  
Tel +86 21 6113-3688  
Fax +86 21 6113-3683