

Application:

Intel Nehalem LGA1156 (45nm) & Intel Sandy Bridge LGA1155 (32nm)

Picture:

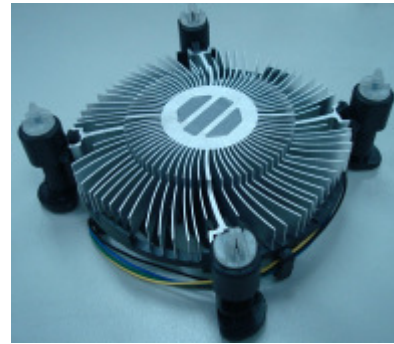

Thermal & Mechanical Spec

Thermal performance for 45 W CPU
 HSK Assembly Weight: 120 g (ref.)
 Clipping Force: 16 Kgf (ref.)

Component Specification:

- Heat Sink
 - Type: Thermal Shrink
 - Material: Aluminum A6063
 - Dimension: 90*90*30 mm
- Thermal interface material
 - Material: Dow Corning TC-5630 or Equivalent.
- Fan

(90x90x17 mm with Thermistor & PWM Control)

Rated Voltage: 12 V

Life Time:
 Superflo bearing 50000 hrs

Connector:

- Lead wire: UL 10368 -F- AWG#28
 - pin 1: black wire-----(-)
 - pin 2: yellow wire-----(+)
 - pin 3: green wire----- (F00)
 - pin 4: blue wire----- (PWM)
- Housing: Molex 47054-1000 or equivalent
- Terminal: Molex 2759T 08-50-0113 or equivalent

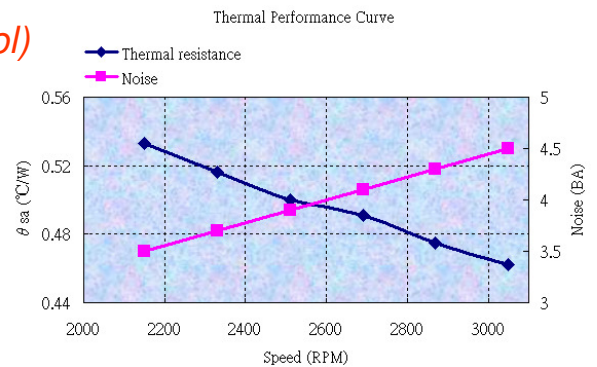

* All readings are typical values at rated voltage.
 * Specifications are subject to change without notice



APPROVAL SHEET

Customer Name : _____

Model Name : COOLER

Model Name : FHS-A9015S00

Customer Part No : _____

Spec Issue Date : 2015/12/14

Spec Revision : 02

PLEASE SEND ONE COPY OF THIS SPECIFICATION BACK AFTER YOU
SIGNED APPROVAL FOR PRODUCTION PRE-ARRANGMENT.

Approved By: _____

Date: _____

Approval	Check	Designer
<i>Charles. Chen</i>	<i>Charles. Chen</i>	<i>Skyler.Huang</i>



Delta Electronics Corp.

REV.	Description	Drawn	Checked	Approved	Issue Date
00	ISSUE SPEC	REEK.LI _{2011/11/25}	Charles.Chen _{2011/11/25}	Alex-Hsia _{2011/11/25}	2011/11/25
01	ADD ROHS	Skyler	Charles.Chen	Alex-Hsia	2013/03/08
02	1. Change the grease from TC-1996 to TC-5630 2. Update RoHS	Skyler	Charles.Chen	Charles.Chen	2015/12/14
Description: SAMPLE REVISION CODE LIST					
Part No.					REV
DELTA MODEL : FHS-A9015S00			TOTAL <u>78</u> PAGE		02



Delta Electronics Corp.

CONTENTS

Item	Element Description	Page	Note
1	Specification	5	
2	Print	6	
3	Packing Plan	14	
4	Fan	17	
5	RoHS Certification	28	



Delta Electronics Corp.

1. SPECIFICATION

Characters

Item	Description
Scope	THIS SPECIFICATION DEFINES THE ELECTRICAL AND MECHANICAL CHARACTERISTICS OF THE HEATSINK
Application	INTEL CPU COOLER
Specification	
a: thermal Resistance	0.52 (°C/W) (REF.)
b: total weight	120 g (REF.)
c: clip force	16 kgf (REF.)

BOM

Item	Part Name	Material	Part NO.	Q'TY	Remark
1	Heatsink	A6063-T5	3346771500	1 pce	
2	FASTENER CAP	PC	3470415400	4 pce	
3	FASTENER BASE	PC	3470415500	4 pce	
4	LABEL	PE	3267128700	1 pce	
5	FAN	PBT	3622920411	1 pce	
6	TIM	DOW TC-5630	4021107300	0.12g	Rev 02



Delta Electronics Corp.

2. PRINT

Assembly Drawing

DRAWING:

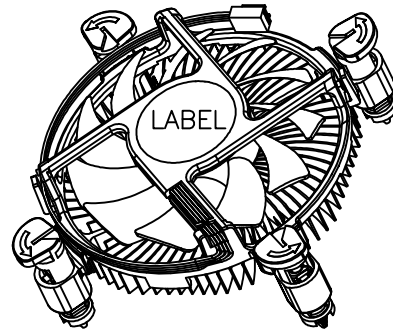
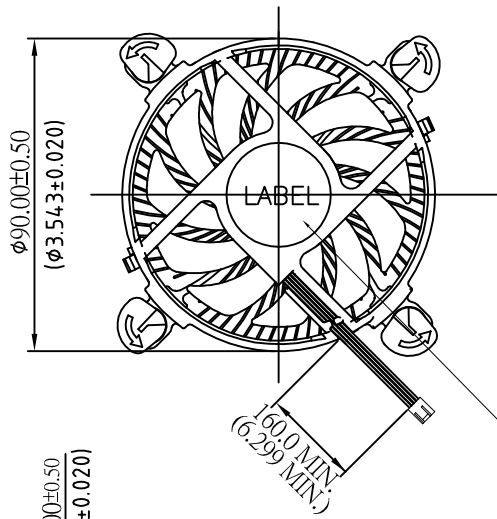

FAN LABEL P/N:3267128700

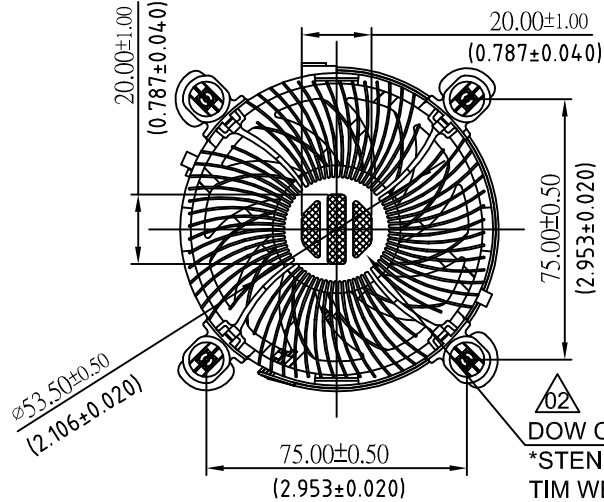
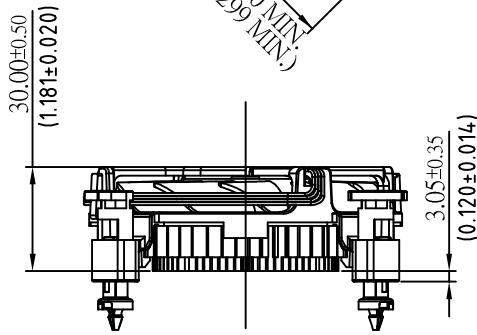

DOW CORNING TC-5630 P/N:4021107300

*STENCIL THICKNESS=0.20(TYP.) 0.22(MAX.)

TIM WEIGHT ON HSK MUST BE 112MG+/-25MG UNIT: $\frac{\text{mm}}{\text{(INCH)}}$

 台達電子工業股份有限公司 DELTA ELECTRONICS, INC.	DELTA MODEL: FHS-A9015S00	Drawn: Skyler 12/14'15																																						
	THESE DRAWINGS AND SPECIFICATIONS ARE THE PROPERTY OF DELTA ELECTRONICS, INC. AND SHALL NOT BE REPRODUCED OR USED AS THE BASIS FOR THE MANUFACTURE OR SELL OF APPARATUS OR DEVICES WITHOUT PERMISSION.																																							
DIMENSIONAL TOLERANCES () () () HOLES : ±0.05 ANGLES : ±0.5		Description: PRODUCTION SPEC. (PHYSICAL DIMENSION)																																						
<table border="1"> <tr> <td><30</td> <td>±0.25</td> <td>DECIMALS</td> <td>UP-100</td> <td>±0.2</td> <td>250-300</td> <td>±0.4</td> <td>UP-600</td> <td>±1.5</td> </tr> <tr> <td>>30-100</td> <td>±0.35</td> <td>X</td> <td>±0.3</td> <td>100-150</td> <td>±0.25</td> <td>300-350</td> <td>±0.45</td> <td>600-900</td> <td>±2.4</td> </tr> <tr> <td>>100-300</td> <td>±0.5</td> <td>XX</td> <td>±0.2</td> <td>150-200</td> <td>±0.3</td> <td>350-400</td> <td>±0.5</td> <td>900-OVER</td> <td>±3.1</td> </tr> <tr> <td>ABOVE 300</td> <td>±0.6</td> <td>XXX</td> <td>±0.1</td> <td>200-250</td> <td>±0.35</td> <td></td> <td></td> <td></td> </tr> </table>		<30	±0.25	DECIMALS	UP-100	±0.2	250-300	±0.4	UP-600	±1.5	>30-100	±0.35	X	±0.3	100-150	±0.25	300-350	±0.45	600-900	±2.4	>100-300	±0.5	XX	±0.2	150-200	±0.3	350-400	±0.5	900-OVER	±3.1	ABOVE 300	±0.6	XXX	±0.1	200-250	±0.35				Part No. FHS-A9015S00-PD
<30	±0.25	DECIMALS	UP-100	±0.2	250-300	±0.4	UP-600	±1.5																																
>30-100	±0.35	X	±0.3	100-150	±0.25	300-350	±0.45	600-900	±2.4																															
>100-300	±0.5	XX	±0.2	150-200	±0.3	350-400	±0.5	900-OVER	±3.1																															
ABOVE 300	±0.6	XXX	±0.1	200-250	±0.35																																			
SCALE --- UNIT mm USED ON COOLER	Description: PRODUCTION SPEC. (PHYSICAL DIMENSION)	Part No. FHS-A9015S00-PD																																						
SIZE A4	SHEET 1 OF 2 ISSUE DATE:	REV. 02																																						

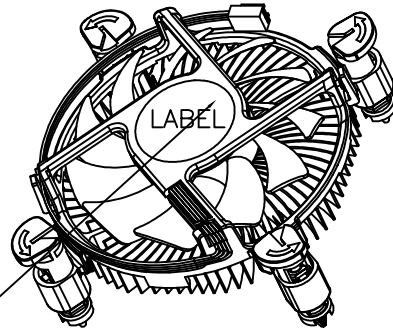
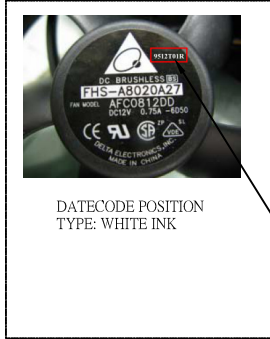

DATECODE POSITION

NOTE:

1. DATECODE ON FAN LABEL.
2. PLEASE REFER TO CP10S-00345 WHILE PRINTING DATECODE.

UNIT: $\frac{\text{mm}}{\text{(INCH)}}$

 台達電子工業股份有限公司 DELTA ELECTRONICS, INC.	DELTA MODEL: FHS-A9015S00	Drawn: Skyler 12/14'15																																							
	THESE DRAWINGS AND SPECIFICATIONS ARE THE PROPERTY OF DELTA ELECTRONICS, INC. AND SHALL NOT BE REPRODUCED OR USED AS THE BASIS FOR THE MANUFACTURE OR SELL OF APPARATUSES OR DEVICES WITHOUT PERMISSION.																																								
DIMENSIONAL TOLERANCES () () () HOLES: ±0.05 ANGLES: ±0.5 <table border="0"> <tr> <td><30</td><td>±0.25</td><td>DECIMALS</td><td>UP-100</td><td>±0.2</td><td>250-300</td><td>±0.4</td><td>UP-600</td><td>±1.5</td> </tr> <tr> <td>>30-100</td><td>±0.35</td><td>X</td><td>±0.3</td><td>100-150</td><td>±0.25</td><td>300-350</td><td>±0.45</td><td>600-900</td><td>±2.4</td> </tr> <tr> <td>>100-300</td><td>±0.5</td><td>X.X</td><td>±0.2</td><td>150-200</td><td>±0.3</td><td>350-400</td><td>±0.5</td><td>900-OVER</td><td>±3.1</td> </tr> <tr> <td>ABOVE 300</td><td>±0.6</td><td>X.XX</td><td>±0.1</td><td>200-250</td><td>±0.35</td><td></td><td></td><td></td><td></td> </tr> </table>	<30	±0.25	DECIMALS	UP-100	±0.2	250-300	±0.4	UP-600	±1.5	>30-100	±0.35	X	±0.3	100-150	±0.25	300-350	±0.45	600-900	±2.4	>100-300	±0.5	X.X	±0.2	150-200	±0.3	350-400	±0.5	900-OVER	±3.1	ABOVE 300	±0.6	X.XX	±0.1	200-250	±0.35					Description: PRODUCTION SPEC. (PHYSICAL DIMENSION)	Part No. FHS-A9015S00-PD
<30	±0.25	DECIMALS	UP-100	±0.2	250-300	±0.4	UP-600	±1.5																																	
>30-100	±0.35	X	±0.3	100-150	±0.25	300-350	±0.45	600-900	±2.4																																
>100-300	±0.5	X.X	±0.2	150-200	±0.3	350-400	±0.5	900-OVER	±3.1																																
ABOVE 300	±0.6	X.XX	±0.1	200-250	±0.35																																				
SCALE: --- UNIT: mm USED ON: COOLER	A4 SIZE	SHEET 2 OF 2 ISSUE DATE:	REV. 02																																						

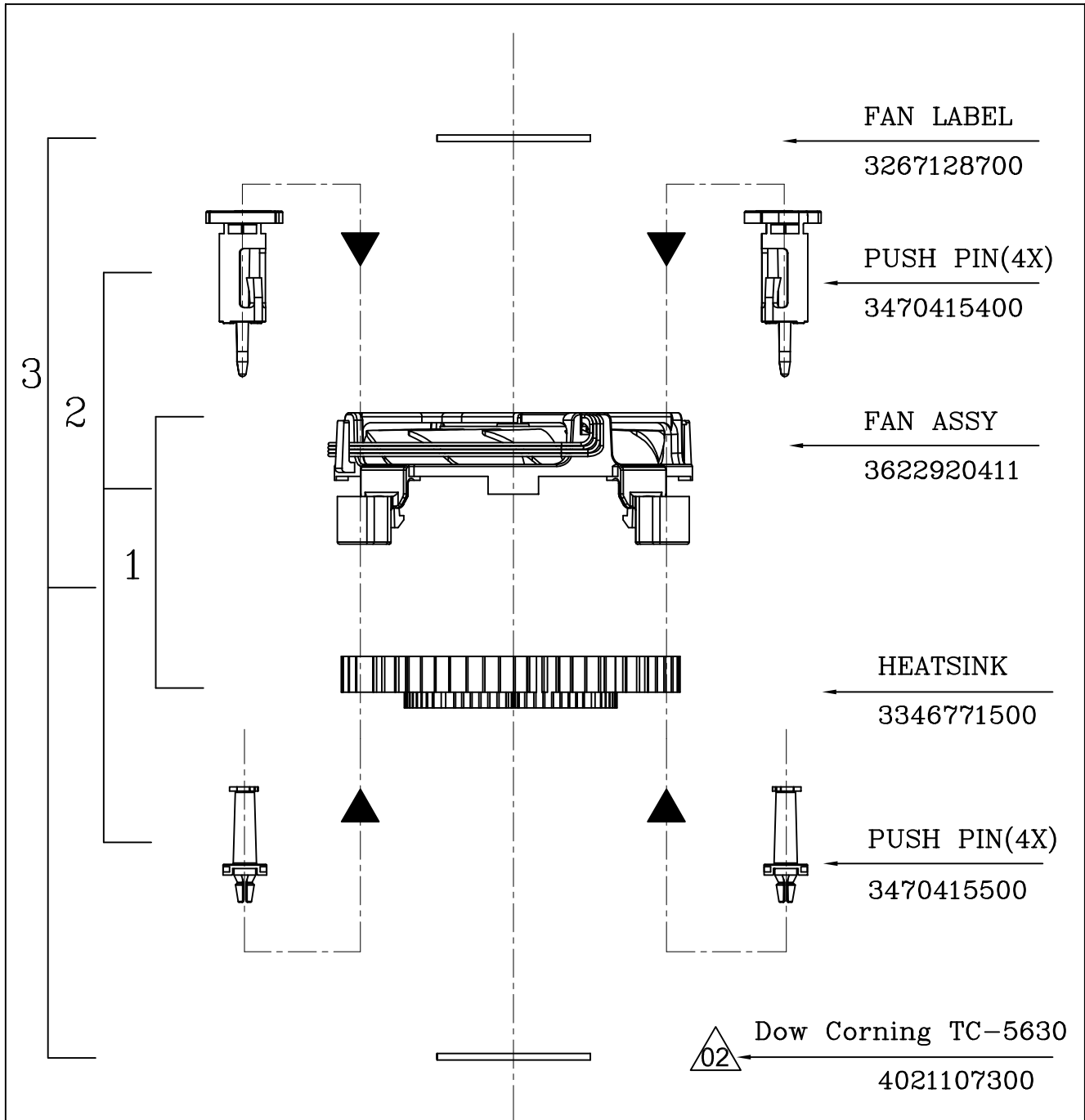

台達電子工業股份有限公司 DELTA ELECTRONICS, INC.	DELTA MODEL: FHS-A9015S00	Drawn: Skyler 12/14'15
	CUSTOMER NAME: STD	CUSTOMER P/N: ---
THESE DRAWINGS AND SPECIFICATIONS ARE THE PROPERTY OF DELTA ELECTRONICS, INC. AND SHALL NOT BE REPRODUCED OR USED AS THE BASIS FOR THE MANUFACTURE OR SELL OF APPARATUS OR DEVICES WITHOUT PERMISSION.	Description: PRODUCTION SPEC. (ASSEMBLY ORDER)	Part No. FHS-A9015S00-AS
DIMENSIONAL TOLERANCES () () () HOLES : ±0.05 ANGLES : ±0.5 <30 ±0.25 DECIMALS UP-100 ±0.2 250-300 ±0.4 () ±1.5 >30-100 ±0.35 X ±0.3 100-150 ±0.25 300-350 ±0.45 600-900 ±2.4 >100-300 ±0.5 X.X ±0.2 150-200 ±0.3 350-400 ±0.5 900-OVER ±3.1 ABOVE 300 ±0.6 X.XX ±0.1 200-250 ±0.35	THIRD ANGLE PROJECTION	REV. 02
SCALE --- UNIT mm USED ON COOLER	A4 SIZE	SHEET 1 OF 1 ISSUE DATE:



Delta Electronics Corp.

Parts Drawing

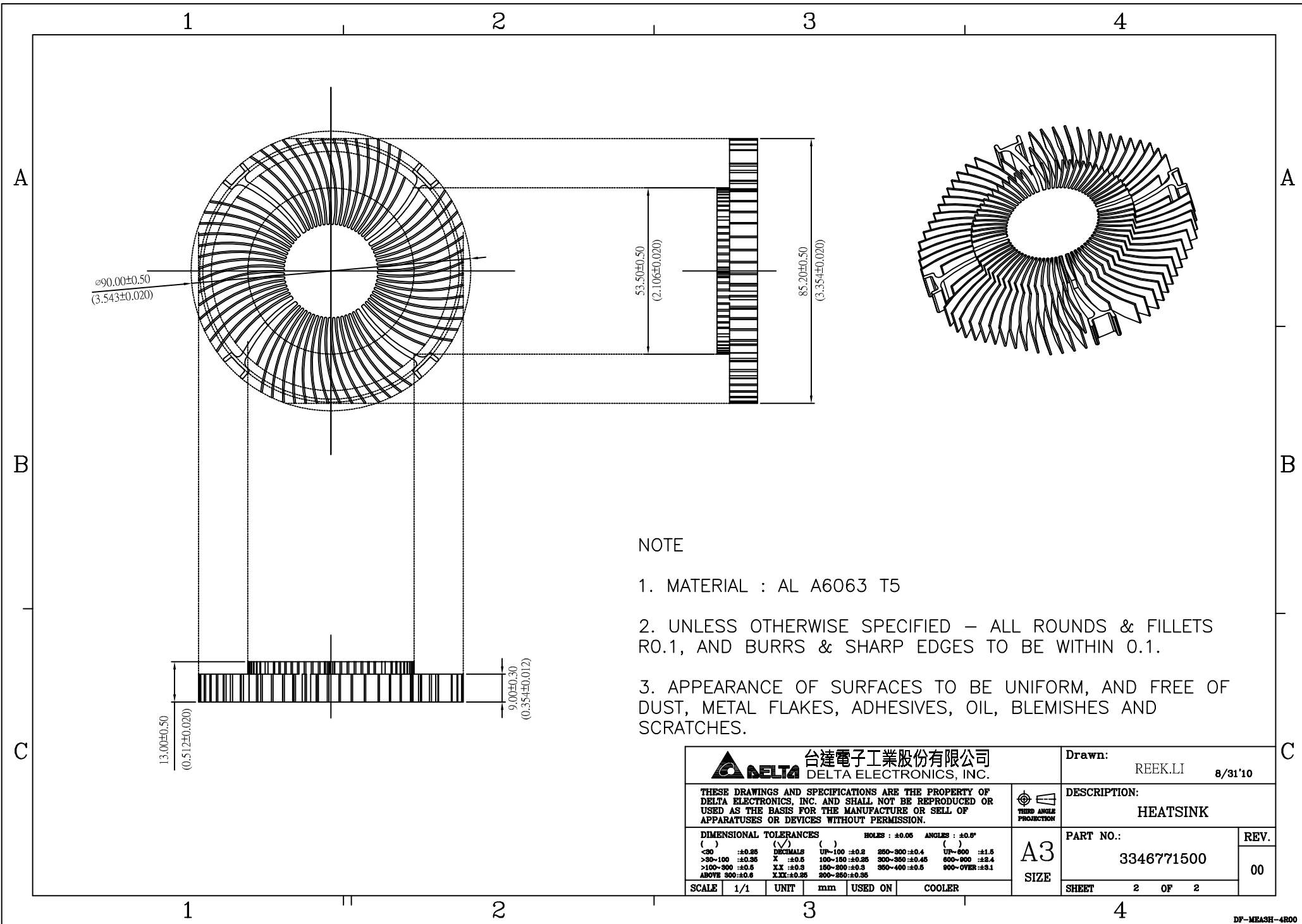

NOTE

1. MATERIAL : AL A6063 T5
2. UNLESS OTHERWISE SPECIFIED – ALL ROUNDS & FILLETS R0.1, AND BURRS & SHARP EDGES TO BE WITHIN 0.1.
3. APPEARANCE OF SURFACES TO BE UNIFORM, AND FREE OF DUST, METAL FLAKES, ADHESIVES, OIL, BLEMISHES AND SCRATCHES.

 台達電子工業股份有限公司 DELTA ELECTRONICS, INC.					Drawn: REEK.LI 8/31'10	
THESE DRAWINGS AND SPECIFICATIONS ARE THE PROPERTY OF DELTA ELECTRONICS, INC. AND SHALL NOT BE REPRODUCED OR USED AS THE BASIS FOR THE MANUFACTURE OR SELL OF APPARATUS OR DEVICES WITHOUT PERMISSION.					DESCRIPTION: HEATSINK	
DIMENSIONAL TOLERANCES () : ±0.25 () : ±0.50 () : ±0.75 () : ±1.00 <30 : ±0.25 X : ±0.5 100-150 : ±0.25 200-250 : ±0.4 500-600 : ±1.6 >30-100 : ±0.25 Y : ±0.5 150-200 : ±0.3 250-300 : ±0.45 600-900 : ±2.4 >100-300 : ±0.5 XX : ±0.3 300-400 : ±0.5 900-OVER : ±3.1 ABOVE 300 : ±0.6 XXX : ±0.25 300-250 : ±0.35					PART NO.: 3346771500	
SCALE 1/1 UNIT mm USED ON COOLER					SHEET 2 OF 2	

1

2

3

4

A

A

B

B

C

C

FAN SPECIFICATION	
FAN TYPE	LINEARLY VARIABLE, DC BRUSHLESS MOTOR
OPERATING VOLTAGE	13.2V MAX, 12V RATED, 10.8V MIN
CURRENT	AVERAGE : 0.15A
	MAXIMUM : 0.46A
	STARTING : 0.73A
SPEED AT STEADY STATE	3100 RPM ± 10%
OPERATING TEMPERATURE	0°C TO +70°C
OPERATING HUMIDITY	85% RELATIVE HUMIDITY @ 55°C
PROTECTION	LOCKED ROTOR, POLARITY
BEARING TYPE	SUPERFLO BEARING

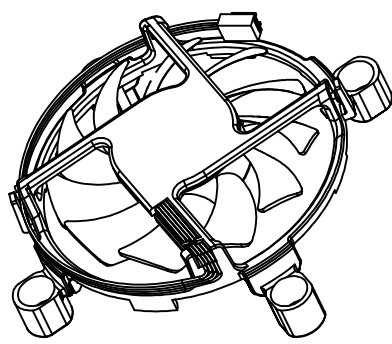
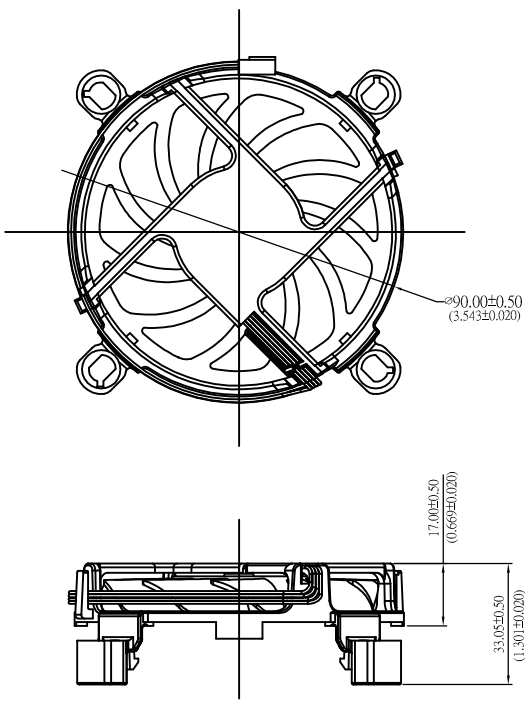

 台達電子工業股份有限公司 DELTA ELECTRONICS, INC.		Drawn: REEK.LI 10/27/09
THESE DRAWINGS AND SPECIFICATIONS ARE THE PROPERTY OF DELTA ELECTRONICS, INC. AND SHALL NOT BE REPRODUCED OR USED AS THE BASIS FOR THE MANUFACTURE OR SELL OF APPARATUS OR DEVICES WITHOUT PERMISSION.		DESCRIPTION: FAN
DIMENSIONAL TOLERANCES () : ±0.25 () : ±0.5 () : ±0.5 <math>< 30</math> : ±0.25 DECIMALS : UP-100 : ±0.2 250-300 : ±0.4 UP-300 : ±1.5 >30-100 : ±0.25 X : ±0.5 100-150 : ±0.25 300-350 : ±0.45 500-900 : ±2.4 >100-300 : ±0.5 XX : ±0.2 150-200 : ±0.3 350-400 : ±0.5 900-OVER : ±3.1 ABOVE 300 : ±0.6 XXX : ±0.1 300-250 : ±0.35		PART NO.: 3622920411
SCALE 1/1 UNIT mm USED ON COOLER	A4 SIZE	REV. -- SHEET 1 OF 1

1

2

3

4

1

2

3

4

A

A

B



B

C

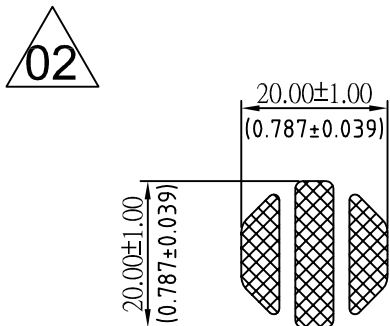
C



- NOTES:
1. THICKNESS: 0.20mm
 2. VENDOR P/N: DOW CORNING TC-5630
 3. COLOR: GRAY.
 4. THERMAL CONDUCTIVITY: 4.5 W/m-°C
 5. THERMAL CONTACT RESISTANCE: 0.06 °C-cm²/W @40psi
 6. GROSS WEIGHT: 112±25 mg
 7. VENDOR : DOW CORNING
 8. MUST MEET DELTA'S SPEC : 10000-0162

 台達電子工業股份有限公司 DELTA ELECTRONICS, INC.		Drawn: Skyler 12/14'15	
THESE DRAWINGS AND SPECIFICATIONS ARE THE PROPERTY OF DELTA ELECTRONICS, INC. AND SHALL NOT BE REPRODUCED OR USED AS THE BASIS FOR THE MANUFACTURE OR SELL OF APPARATUS OR DEVICES WITHOUT PERMISSION.		 DESCRIPTION: THERMAL INTERFACE	
DIMENSIONAL TOLERANCES () ±0.25 (✓) () <30 ±0.25 DECIMALS UP-100 ±0.2 250-300 ±0.4 UP-600 ±1.6 >30-100 ±0.25 X ±0.5 100-150 ±0.25 300-350 ±0.45 600-900 ±2.4 >100-300 ±0.5 XX ±0.8 150-200 ±0.3 350-400 ±0.5 900-OVER ±3.1 ABOVE 300 ±0.6 XXX ±0.1 300-250 ±0.25		PART NO.: 4021107300	
SCALE 1/1 UNIT mm USED ON COOLER		REV. 02	

1

2

3

4



Delta Electronics Corp.

3. PACKING PLAN

Packing Specification

CARTON ILLUSTRATE	SIZE	530(L)*230(w)*315(H)(mm)	PACKING QUANTITY	5LAYERS/CARTON
	MATERIAL	3 LAYERS"AB" FLUTE	CARTON WEIGHT	0.62 kg (REF.)

CARTON OUTSIDE ILLUSTRATE

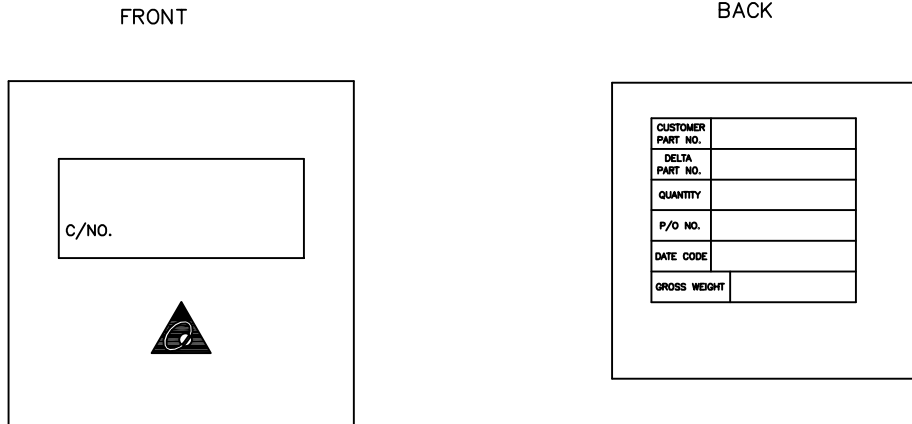

(ONE LABEL PER CARTON)

PET TRAY PACKING ILLUSTRATE	SIZE	94(L)*94(w)*30(H)(mm)	PACKING QUANTITY	1PCS/PET TRAY
	MATERIAL	PET TRAY		
	MATERIAL WEIGHT	6g (REF.)		

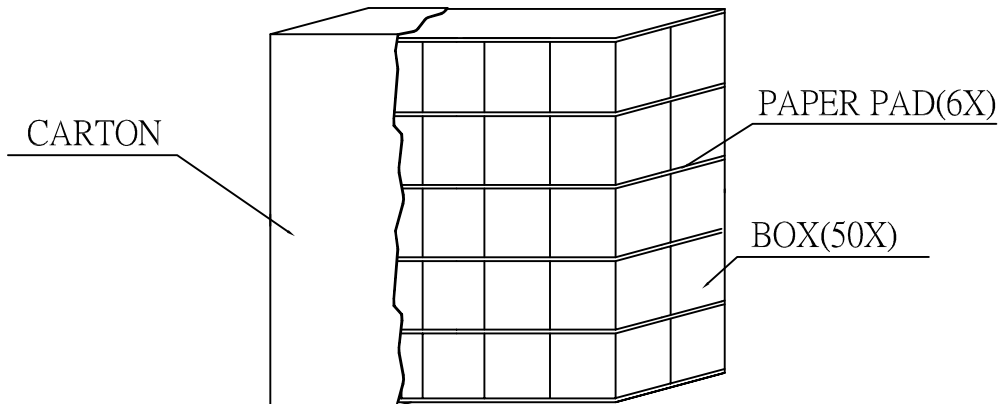

台達電子工業股份有限公司 DELTA ELECTRONICS, INC.	DELTA MODEL:	Drawn:
	FHS-A9015S00	REEK.LI 11/25/11
THESE DRAWINGS AND SPECIFICATIONS ARE THE PROPERTY OF DELTA ELECTRONICS, INC. AND SHALL NOT BE REPRODUCED OR USED AS THE BASIS FOR THE MANUFACTURE OR SELL OF APPARATUS OR DEVICES WITHOUT PERMISSION.	CUSTOMER NAME:	STD
	CUSTOMER P/N:	---
DIMENSIONAL TOLERANCES () () () HOLES : ±0.05 ANGLES : ±0.5° () () () <30 :±0.25 DECIMALS UP~100 :±0.2 250~300 :±0.4 UP~800 :±1.5 >30~100 :±0.35 X :±0.3 100~150 :±0.25 300~350 :±0.45 600~900 :±2.4 >100~300 :±0.5 XX :±0.2 150~200 :±0.3 350~400 :±0.5 900~OVER :±3.1 ABOVE 300 :±0.6 XXX :±0.1 200~250 :±0.35	Description: PRODUCTION SPEC. (PACKING ASSMBLY)	REV.
	A4 SIZE	
SCALE ---	UNIT mm	USED ON COOLER

PART NO.	FHS-A9015S00		
BASIC DATA	QUANTITY /CARTON	50PCS (5 LAYERS/CARTON, 10PCS/LAYER)	
	PRODUCTION NET WEIGHT	7.8kg (REF.)	
	PRODUCTION GROSS WEIGHT	9.8kg (REF.)	
20(ft)CONTAINER ILLUSTRATE	SIZE	5.889(L)*2.352(w)*2.386(H)m	PACKING QUANTITY
	CONTAINER	STEEL	10PALLETS/CONTAINER

CONTAINER FORM

CONTAINER LOADING MATHOD

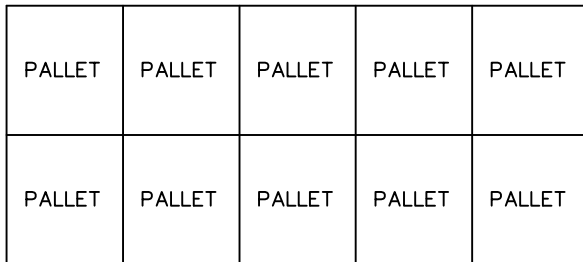

TOP VIEW

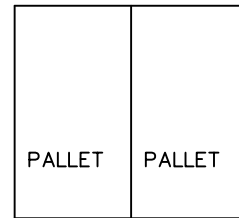



FRONT VIEW

PALLET LOADING ILLUSTRATE	SIZE	117(L)*107(w)*13(H)cm	PACKING QUANTITY	50 CARTONS/PALLET
	PALLET	WOOD		

PALLET ILLUSTRATE

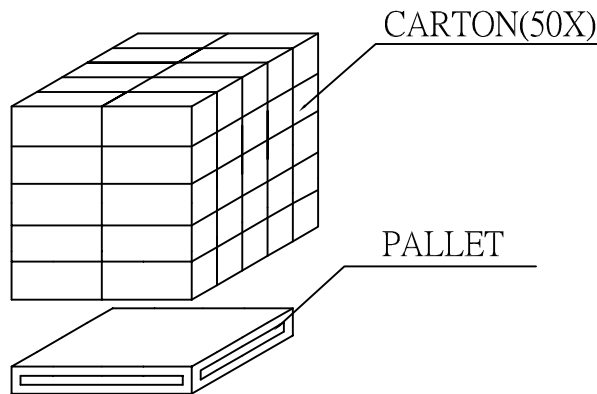
PALLET LOADING MATHOD



 台達電子工業股份有限公司 DELTA ELECTRONICS, INC.	DELTA MODEL:	Drawn:
	FHS-A9015S00	REEK.LI 11/25/11
THESE DRAWINGS AND SPECIFICATIONS ARE THE PROPERTY OF DELTA ELECTRONICS, INC. AND SHALL NOT BE REPRODUCED OR USED AS THE BASIS FOR THE MANUFACTURE OR SELL OF APPARATUSES OR DEVICES WITHOUT PERMISSION.	CUSTOMER NAME:	STD
	CUSTOMER P/N:	---
DIMENSIONAL TOLERANCES () () () HOLES : ±0.05 ANGLES : ±0.5° <30 :±0.25 DECIMALS UP~100 :±0.2 250~300 :±0.4 UP~600 :±1.5 >30~100 :±0.35 X :±0.3 100~150 :±0.25 300~350 :±0.45 600~900 :±2.4 >100~300 :±0.5 XX :±0.2 150~200 :±0.3 350~400 :±0.5 900~OVER :±3.1 ABOVE 300 :±0.6 XXX :±0.1 200~250 :±0.35	 Description: PRODUCTION SPEC. (PACKING ASSMEBLY)	REV.
	A4 SIZE	
SCALE ---	UNIT mm	USED ON COOLER



Delta Electronics Corp.

4. FAN



SPECIFICATION FOR APPROVAL

Customer TMPBU

Description DC FAN

Part No. _____ REV. _____

Delta Model No. AUC0912D-AF1F REV. 00

Sample Issue No. _____

Sample Issue Date SEP.15.2010

PLEASE SEND ONE COPY OF THIS SPECIFICATION
BACK AFTER YOU SIGNED APPROVAL FOR
PRODUCTION PRE-ARRANGMENT.

APPROVED BY: _____

DATE : _____

DELTA ELECTRONICS, INC.
TAOYUAN PLANT
252, SHANG YING ROAD, KUEI SAN INDUSTRIAL ZONE
TAOYUAN SHIEN, TAIWAN, R.O.C.
TEL:886-(0)3-3591968
FAX:886-(0)3-3591991

DELTA ELECTRONICS, INC.
 252, SHANG YING ROAD, KUEI SAN
 TAOYUAN HSIEN 333, TAIWAN, R. O. C.

TEL : 886-(0)3-3591968
 FAX : 886-(0)3-3591991

SPECIFICATION FOR APPROVAL

Customer: TMPBU

 Description: DC FAN

 Customer P/N: REV:

 Delta Model NO.: AUC0912D-AF1F Delta Safety Model NO.: N/A

 Sample Rev: 00 Issue NO:

 Sample Issue Date: SEP.15.2010 Quantity:

1. SCOPE:

THIS SPECIFICATION DEFINES THE ELECTRICAL AND MECHANICAL CHARACTERISTICS OF THE DC BRUSHLESS AXIAL FLOW FAN. THE FAN MOTOR IS WITH SINGLE PHASE AND FOUR POLES.

2. CHARACTERS:

ITEM	DESCRIPTION
RATED VOLTAGE	12.0 VDC
OPERATION VOLTAGE	10.8 - 13.2 VDC
INPUT CURRENT	0.15 (MAX. 0.22) A (SAFETY CURRENT 0.46 A)
INPUT POWER	1.80 (MAX. 2.64) W
SPEED (FAN ONLY)	3100±10% R.P.M.
SPEED (FAN ON SINK)	3100±10% R.P.M.
MAX. AIR FLOW (FAN ONLY) (AT ZERO STATIC PRESSURE)	0.643 (MIN. 0.578) M ³ /MIN. 22.68 (MIN. 20.41) CFM
MAX. AIR PRESSURE (FAN ONLY) (AT ZERO AIRFLOW)	1.66 (MIN. 1.34) mmH ₂ O 0.065 (MIN. 0.053) inchH ₂ O
ACOUSTICAL NOISE(ON SINK AVG.)	32.6 (MAX. 36.6) dB-A
INSULATION TYPE	UL: CLASS A

(continued)

PART NO:

DELTA MODEL: AUC0912D-AF1F

INSULATION STRENGTH	10 MEG OHM MIN. AT 500 VDC (BETWEEN FRAME AND (+) TERMINAL)
DIELECTRIC STRENGTH	5 mA MAX. AT 500 VAC 50/60 Hz ONE MINUTE, (BETWEEN FRAME AND (+) TERMINAL)
EXTERNAL COVER	OPEN TYPE
LIFE EXPECTANCE	80,000 HOURS CONTINUOUS OPERATION AT 45 °C WITH 15 ~ 65 %RH.
ROTATION	CLOCKWISE VIEW FROM NAME PLATE SIDE
OVER CURRENT SHUT DOWN	THE CURRENT WILL SHUT DOWN WHEN LOCKING ROTOR.
LEAD WIRE	UL 10368 -F- AWG #28 BLACK WIRE NEGATIVE(-) YELLOW WIRE POSITIVE(+) GREEN WIRE FREQUENCY(-F00) BLUE WIRE SPEED CONTROL(PWM)

- NOTES: 1. ALL READINGS ARE MEASURED AFTER STABLY WARMING UP THROUGH 10 MINUTES.
2. THE VALUES WRITTEN IN PARENS , (), ARE LIMITED SPEC.
3. ACOUSTICAL NOISE MEASURING CONDITION:

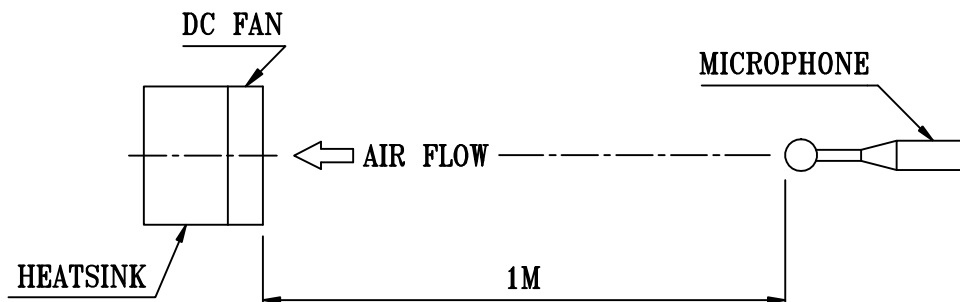

NOISE IS MEASURED AT RATED VOLTAGE IN FREE AIR IN ANECHOIC CHAMBER WITH B & K SOUND LEVEL METER WITH MICROPHONE AT A DISTANCE OF ONE METER FROM THE FAN INTAKE.

PART NO:

DELTA MODEL: AUC0912D-AF1F

3. MECHANICAL:

- 3-1. DIMENSIONS ----- SEE DIMENSIONS DRAWING
- 3-2. FRAME ----- PLASTIC UL: 94V-0
(THE CONTACT OF HALOGEN LESS THAN 1500 PPM FOR USING EDX ...ETC)
- 3-3. IMPELLER ----- PLASTIC UL: 94V-0
(THE CONTACT OF HALOGEN LESS THAN 1500 PPM FOR USING EDX ...ETC)
- 3-4. BEARING SYSTEM ----- SUPERFLO BEARING
- 3-5. WEIGHT ----- 55 GRAMS

4. ENVIRONMENTAL:

- 4-1. OPERATING TEMPERATURE ----- 0 TO +70 DEGREE C
- 4-2. STORAGE TEMPERATURE ----- -30 TO +85 DEGREE C
- 4-3. OPERATING HUMIDITY --- 85% RELATIVE HUMIDITY WITH 55 DEGREE C
- 4-4. STORAGE HUMIDITY ----- 5 TO 95 % RH

5. PROTECTION:

- 5-1. LOCKED ROTOR PROTECTION
IMPEDANCE OF MOTOR WINDING PROTECTS MOTOR FROM FIRE IN 96
- 5-2. POLARITY PROTECTION
HOURS OF LOCKED ROTOR CONDITION AT THE RATED VOLTAGE.
BE CAPABLE OF WITHSTANDING IF REVERSE CONNECTION FOR POSITIVE
AND NEGATIVE LEADS.

6. RE OZONE DEPLETING SUBSTANCES:

- 6-1. NO CONTAINING PBBs, PBBOs, CFCs, PBBEs, PBDPEs AND HCFCs.

7. PRODUCTION LOCATION

- 7-1. PRODUCTS WILL BE PRODUCED IN CHINA OR THAILAND OR TAIWAN.

PART NO:

DELTA MODEL: AUC0912D-AF1F

8. P & Q CURVE:

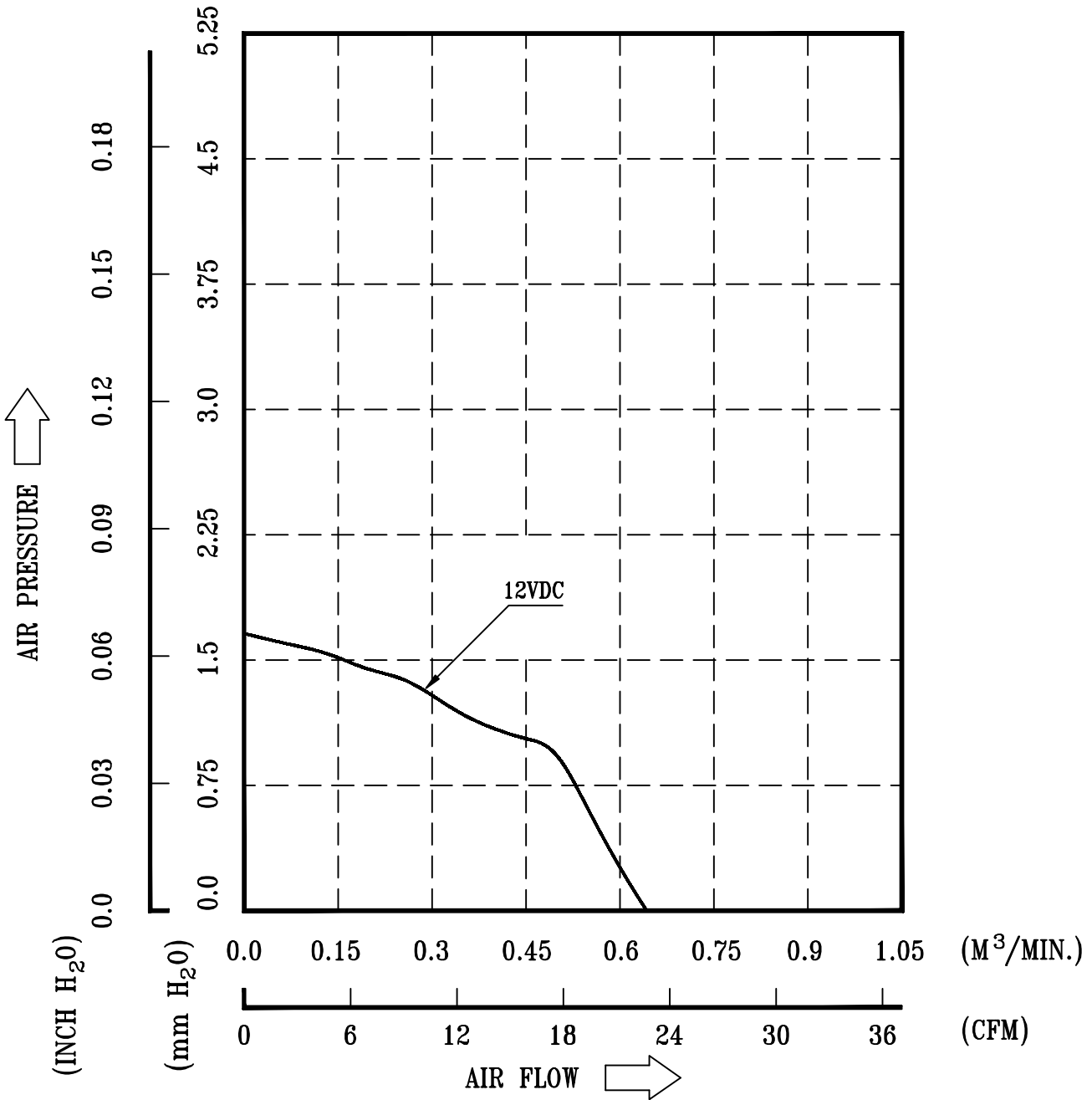

* TEST CONDITION: INPUT VOLTAGE ----- OPERATION VOLTAGE
TEMPERATURE ----- ROOM TEMPERATURE
HUMIDITY ----- 65%RH

PART NO:

DELTA MODEL: AUC0912D-AF1F

9. DIMENSION DRAWING:

LABEL:

DELTA AUC0912D
-AF1F
yymmdd
CHINA

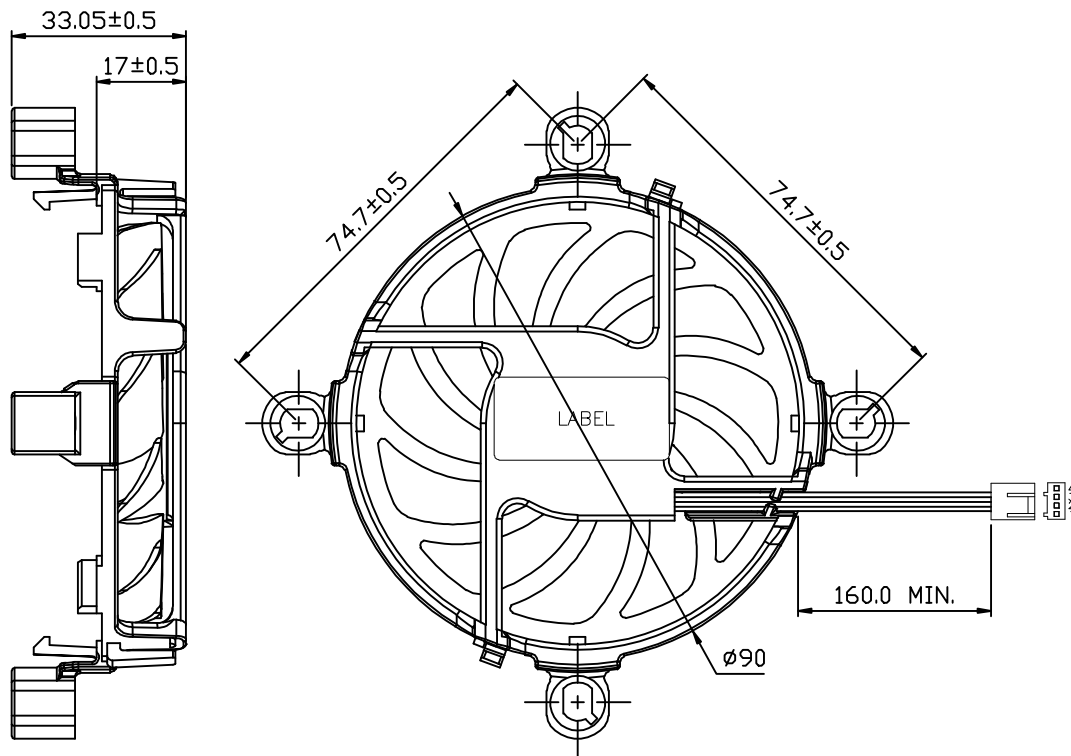

UNIT: mm

NOTE :

1. LEAD WIRE: UL 10368 -F- AWG #28
PIN 1 : BLACK WIRE: NEGATIVE(-)
PIN 2 : YELLOW WIRE: POSITIVE(+)
PIN 3 : GREEN WIRE: TACHOMETER OUTPUT (F00)
PIN 4 : BLUE WIRE: SPEED CONTROL (PWM)
2. HOUSING : MOLEX 47054-1000 OR EQUIVALENT
3. TERMINAL : MOLEX 2759T 08-50-0113 OR EQUIVALENT
4. THIS PRODUCT IS RoHS COMPLIANT
5. DELTA'S RESTRICTIONS ON HALOGEN APPLY ONLY TO BROMINATED AND CHLORINATED COMPOUNDS. NO OTHER HALOGEN IS RESTRICTED. SUBSTANCES RESTRICTIONS FOR HALOGEN-FREE (INCLUDE FAN PLASTIC PARTS, PWB BOARD, IC, ELECTRICAL MATERIALS & CABLE ASSY),
 - a. BROMINE(Br) < 900 PPM,
 - b. CHLORINE(Cl) < 900 PPM
 - c. (Br) + (Cl) < 1500 PPM.

PART NO:

DELTA MODEL: AUC0912D-AF1F

10. FREQUENCY GENERATOR (FG) SIGNAL:

10-1. OUTPUT CIRCUIT - OPEN COLLECTOR MODE:

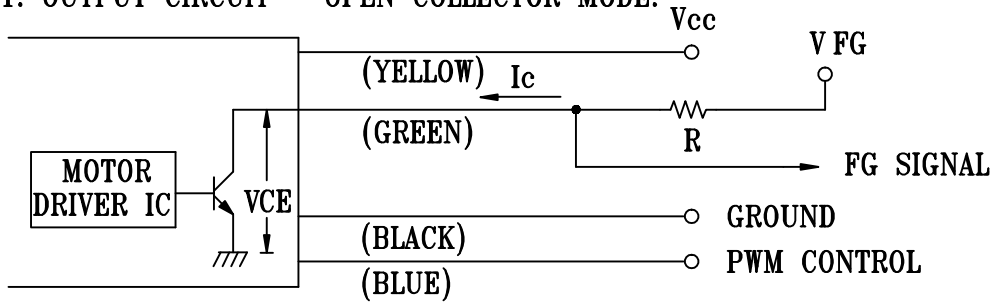

CAUTION: THE FG SIGNAL LEAD WIRE MUST BE KEPT AWAY FROM "+" LEAD WIRE & "-" LEAD WIRE.

10-2. SPECIFICATION:

$V_{ce} \text{ (sat)} = 0.5V \text{ MAX.}$

$V_{FG} = 5.0V \text{ TYP. (} V_{cc} \text{ MAX.)}$

$I_c = 5mA \text{ MAX.}$

$R \geq V_{FG} / I_c$

10-3. FREQUENCY GENERATOR WAVEFORM:

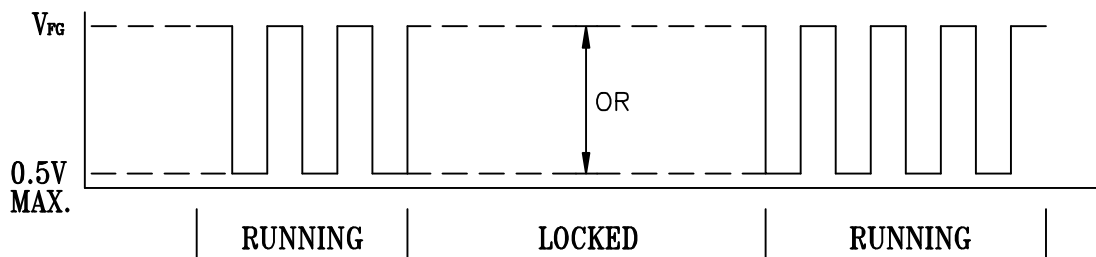

FAN RUNNING FOR 4 POLES

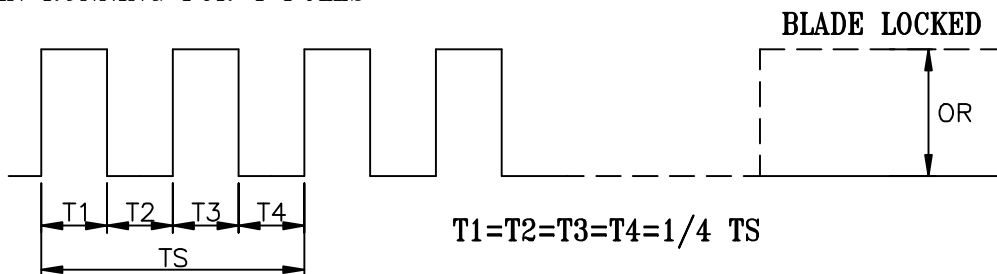

$N = \text{R.P.M}$

$TS = 60/N(\text{SEC})$

*VOLTAGE LEVEL AFTER BLADE LOCKED

*4 POLES

PART NO:

DELTA MODEL: AUC0912D-AF1F

11. PWM CONTROL SIGNAL:(FAN ON SINK)

11-1. SIGNAL VOLTAGE RANGE: 0~20 VDC

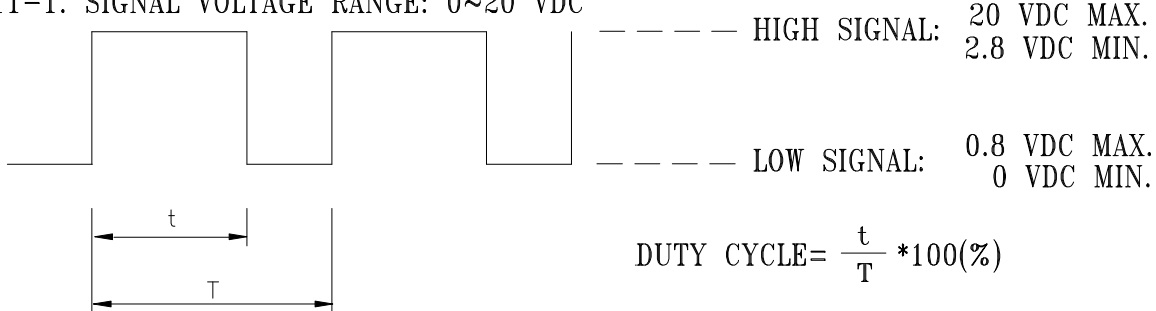

- THE PREFERRED OPERATING POINT FOR THE FAN IS 25KHZ.
- AT 100% DUTY CYCLE,THE ROTOR WILL SPIN AT MAXIMUM SPEED.
- WITH CONTROL SIGNAL LEAD DISCONNECTED,THE FAN WILL SPIN AT MAXIMUM SPEED.

11-2. SPEED VS PWM CONTROL SIGNAL:

(AT 25°C, RATED VOLTAGE & PWM SIGNAL AS FOLLOW)

DUTY CYCLE (%)	SPEED R.P.M.	CURRENT (A) TYP.
100	3100±10%	0.15
0~20	1000±200	0.03

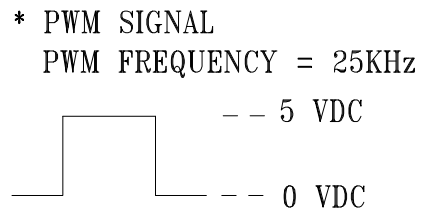

PART NO:

DELTA MODEL: AUC0912D-AF1F

12. PWM CONTROL SIGNAL:(FAN ONLY)

12-1. SIGNAL VOLTAGE RANGE: 0~20 VDC

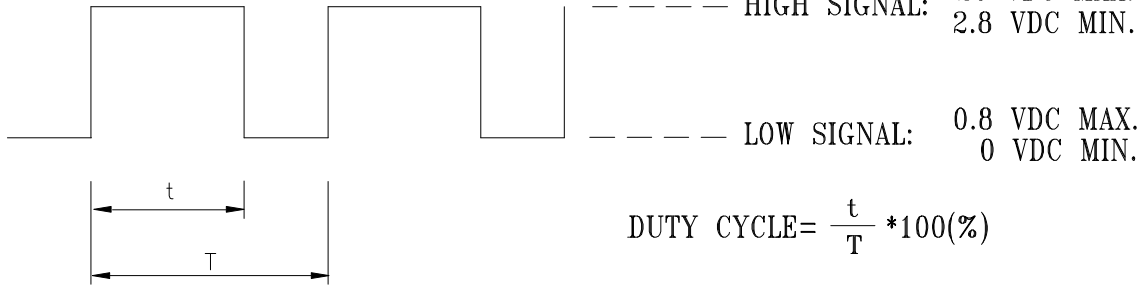

- THE PREFERRED OPERATING POINT FOR THE FAN IS 25KHZ.
- AT 100% DUTY CYCLE,THE ROTOR WILL SPIN AT MAXIMUM SPEED.
- WITH CONTROL SIGNAL LEAD DISCONNECTED,THE FAN WILL SPIN AT MAXIMUM SPEED.

12-2. SPEED VS PWM CONTROL SIGNAL:

(AT 25°C, RATED VOLTAGE & PWM SIGNAL AS FOLLOW)

DUTY CYCLE (%)	SPEED R.P.M.	CURRENT (A) TYP.
100	3100±10%	0.15
0~20	1000±200	0.03

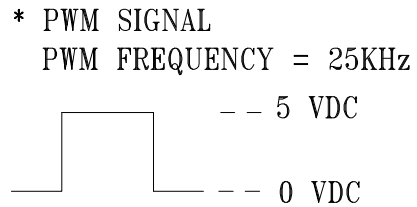

12-3. PWM CONTROL LEAD WIRE INPUT IMPEDANCE:

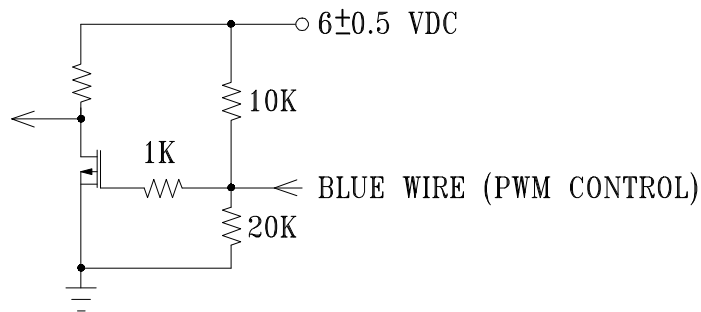



Application Notice

- 1. Delta will not guarantee the performance of the products if the application condition falls outside the parameters set forth in the specification.**
- 2. A written request should be submitted to Delta prior to approval if deviation from this specification is required.**
- 3. Please exercise caution when handling fans. Damage may be caused when pressure is applied to the impeller, if the fans are handled by the lead wires, or if the fan was hard-dropped to the production floor.**
- 4. Except as pertains to some special designs, there is no guarantee that the products will be free from any such safety problems or failures as caused by the introduction of powder, droplets of water or encroachment of insect into the hub.**
- 5. The above-mentioned conditions are representative of some unique examples and viewed as the first point of reference prior to all other information.**
- 6. It is very important to establish the correct polarity before connecting the fan to the power source. Positive (+) and Negative (-). Damage may be caused to the fans if connection is with reverse polarity, if there is no foolproof method to protect against such error specifically mentioned in this spec.**
- 7. Delta fans without special protection are not suitable where any corrosive fluids are introduced to their environment.**
- 8. Please ensure all fans are stored according to the storage temperature limits specified. Do not store fans in a high humidity environment. We highly recommend performance testing is conducted before shipping, if the fans have been stored over 6 months.**
- 9. Not all fans are provided with the Lock Rotor Protection feature. If you impair the rotation of the impeller for the fans that do not have this function, the performance of those fans will lead to failure.**
- 10. Please be cautious when mounting the fan. Incorrect mounting of fans may cause excess resonance, vibration and subsequent noise.**
- 11. It is important to consider safety when testing the fans. A suitable fan guard should be fitted to the fan to guard against any potential for personal injury.**
- 12. Except where specifically stated, all tests are carried out at room (ambient) temperature and relative humidity conditions of 25°C, 65% RH. The test value is only for fan performance itself.**
- 13. Be certain to connect an “4.7µF or greater” capacitor to the fan externally when the application calls for using multiple fans in parallel, to avoid any unstable power.**



Delta Electronics Corp.

5. ROHS

5.1. PBT

5.2. AL6063-T5

5.3. PC

5.4. PET 、 INK 、 COATING

5.5. DOW TC-5630

Test Report

No. CANEC1503047702

Date: 13 Mar 2015

Page 1 of 13

KINGFA SCI. & TECH. CO., LTD.

NO.33 KEFENG ROAD,SCIENCE CITY,GUANGZHOU HI-TECHINDUSTRIAL DEVELOPMENT ZONE,GUANGZHOU CITY CHINA

The following sample(s) was/were submitted and identified on behalf of the clients as : PBT-NPG30

SGS Job No. : CP15-009615 - GZ

Date of Sample Received : 09 Mar 2015

Testing Period : 09 Mar 2015 - 13 Mar 2015

Test Requested : Selected test(s) as requested by client.

Test Method : Please refer to next page(s).

Test Results : Please refer to next page(s).

Conclusion : Based on the performed tests on submitted sample(s), the results of Lead, Mercury, Cadmium, Hexavalent chromium, Polybrominated biphenyls (PBBs), Polybrominated diphenyl ethers (PBDEs) comply with the limits as set by RoHS Directive 2011/65/EU Annex II; recasting 2002/95/EC.

Signed for and on behalf of
SGS-CSTC Standards Technical Services Co., Ltd. Guangzhou Branch



Alkene Liang
Approved Signatory



This document is issued by the Company subject to its General Conditions of Service printed overleaf, available on request or accessible at <http://www.sgs.com/en/Terms-and-Conditions.aspx> and, for electronic format documents, subject to Terms and Conditions for Electronic Documents at <http://www.sgs.com/en/Terms-and-Conditions/Terms-e-Documents.aspx>. Attention is drawn to the limitation of liability, indemnification and jurisdiction issues defined therein. Any holder of this document is advised that information contained hereon reflects the Company's findings at the time of its intervention only and within the limits of Client's instructions, if any. The Company's sole responsibility is to its Client and this document does not exonerate parties to a transaction from exercising all their rights and obligations under the transaction documents. This document cannot be reproduced except in full, without prior written approval of the Company. Any unauthorized alteration, forgery or falsification of the content or appearance of this document is unlawful and offenders may be prosecuted to the fullest extent of the law. Unless otherwise stated the results shown in this test report refer only to the sample(s) tested.

Attention: To check the authenticity of testing /inspection report & certificate, please contact us at telephone: (86-755) 8307 1443, or email: CN.Doccheck@sgs.com

198 Kezhu Road, Sciencetech Park Guangzhou Economic & Technology Development District, Guangzhou, China 510663 t (86-20) 82155555 f (86-20) 82075113 www.sgsgroup.com.cn
中国·广州·经济技术开发区科学城科珠路198号 邮编: 510663 t (86-20) 82155555 f (86-20) 82075113 e sgs.china@sgs.com

Test Report

No. CANEC1503047702

Date: 13 Mar 2015

Page 2 of 13

Test Results :

Test Part Description :

Specimen No.	SGS Sample ID	Description
SN1	CAN15-030477.002	Black plastic grains

Remarks :

- (1) 1 mg/kg = 0.0001%
- (2) MDL = Method Detection Limit
- (3) ND = Not Detected (< MDL)
- (4) "-" = Not Regulated

RoHS Directive 2011/65/EU

- Test Method :
- (1)With reference to IEC 62321-5:2013, determination of Cadmium by ICP-OES.
 - (2)With reference to IEC 62321-5:2013, determination of Lead by ICP-OES.
 - (3)With reference to IEC 62321-4:2013, determination of Mercury by ICP-OES.
 - (4)With reference to IEC 62321:2008, determination of Hexavalent Chromium by Colorimetric Method using UV-Vis.
 - (5)With reference to IEC 62321:2008, determination of PBBs and PBDEs by GC-MS.

<u>Test Item(s)</u>	<u>Limit</u>	<u>Unit</u>	<u>MDL</u>	<u>002</u>
Cadmium (Cd)	100	mg/kg	2	ND
Lead (Pb)	1,000	mg/kg	2	5
Mercury (Hg)	1,000	mg/kg	2	ND
Hexavalent Chromium (CrVI)	1,000	mg/kg	2	ND
Sum of PBBs	1,000	mg/kg	-	ND
Monobromobiphenyl	-	mg/kg	5	ND
Dibromobiphenyl	-	mg/kg	5	ND
Tribromobiphenyl	-	mg/kg	5	ND
Tetrabromobiphenyl	-	mg/kg	5	ND
Pentabromobiphenyl	-	mg/kg	5	ND
Hexabromobiphenyl	-	mg/kg	5	ND
Heptabromobiphenyl	-	mg/kg	5	ND
Octabromobiphenyl	-	mg/kg	5	ND
Nonabromobiphenyl	-	mg/kg	5	ND
Decabromobiphenyl	-	mg/kg	5	ND
Sum of PBDEs	1,000	mg/kg	-	ND
Monobromodiphenyl ether	-	mg/kg	5	ND



This document is issued by the Company subject to its General Conditions of Service printed overleaf, available on request or accessible at <http://www.sgs.com/en/Terms-and-Conditions.aspx> and, for electronic format documents, subject to Terms and Conditions for Electronic Documents at <http://www.sgs.com/en/Terms-and-Conditions/Terms-e-Documents.aspx>. Attention is drawn to the limitation of liability, indemnification and jurisdiction issues defined therein. Any holder of this document is advised that information contained hereon reflects the Company's findings at the time of its intervention only and within the limits of Client's instructions, if any. The Company's sole responsibility is to its Client and this document does not exonerate parties to a transaction from exercising all their rights and obligations under the transaction documents. This document cannot be reproduced except in full, without prior written approval of the Company. Any unauthorized alteration, forgery or falsification of the content or appearance of this document is unlawful and offenders may be prosecuted to the fullest extent of the law. Unless otherwise stated the results shown in this test report refer only to the sample(s) tested.

Attention: To check the authenticity of testing /inspection report & certificate, please contact us at telephone: (86-755) 8307 1443, or email: CN.Doccheck@sgs.com

Test Report

No. CANEC1503047702

Date: 13 Mar 2015

Page 3 of 13

<u>Test Item(s)</u>	<u>Limit</u>	<u>Unit</u>	<u>MDL</u>	<u>002</u>
Dibromodiphenyl ether	-	mg/kg	5	ND
Tribromodiphenyl ether	-	mg/kg	5	ND
Tetrabromodiphenyl ether	-	mg/kg	5	ND
Pentabromodiphenyl ether	-	mg/kg	5	ND
Hexabromodiphenyl ether	-	mg/kg	5	ND
Heptabromodiphenyl ether	-	mg/kg	5	ND
Octabromodiphenyl ether	-	mg/kg	5	ND
Nonabromodiphenyl ether	-	mg/kg	5	ND
Decabromodiphenyl ether	-	mg/kg	5	ND

Notes :

(1) The maximum permissible limit is quoted from the directive 2011/65/EU, Annex II

Halogen

Test Method : With reference to EN 14582: 2007, analysis was performed by Ion Chromatograph (IC).

<u>Test Item(s)</u>	<u>Unit</u>	<u>MDL</u>	<u>002</u>
Chlorine (Cl)	mg/kg	50	ND
Bromine (Br)	mg/kg	50	ND

Elementary Analysis

Test Method : With reference to US EPA Method 3052:1996, analysis was performed by ICP-OES.

<u>Test Item(s)</u>	<u>Unit</u>	<u>MDL</u>	<u>002</u>
Sb ₂ O ₃	mg/kg	12	ND

Notes :

(1) ♦ Calculated concentration of Sb₂O₃ is based on the identified Sb

Polynuclear Aromatic Hydrocarbons (PAHs)

Test Method : With reference to ZEK 01.4-08 of German ZLS and its amendments, analysis was performed by GC-MS.



This document is issued by the Company subject to its General Conditions of Service printed overleaf, available on request or accessible at <http://www.sgs.com/en/Terms-and-Conditions.aspx> and, for electronic format documents, subject to Terms and Conditions for Electronic Documents at <http://www.sgs.com/en/Terms-and-Conditions/Terms-e-Documents.aspx>. Attention is drawn to the limitation of liability, indemnification and jurisdiction issues defined therein. Any holder of this document is advised that information contained hereon reflects the Company's findings at the time of its intervention only and within the limits of Client's instructions, if any. The Company's sole responsibility is to its Client and this document does not exonerate parties to a transaction from exercising all their rights and obligations under the transaction documents. This document cannot be reproduced except in full, without prior written approval of the Company. Any unauthorized alteration, forgery or falsification of the content or appearance of this document is unlawful and offenders may be prosecuted to the fullest extent of the law. Unless otherwise stated the results shown in this test report refer only to the sample(s) tested.

Attention: To check the authenticity of testing / inspection report & certificate, please contact us at telephone: (86-755) 8307 1443, or email: CN.Doccheck@sgs.com

SGS-CTC Standards Technical Services Co., Ltd.
Guangzhou Chemical Laboratory

198 Kezhu Road, Sciencetech Park Guangzhou Economic & Technology Development District, Guangzhou, China 510663 t (86-20) 82155555 f (86-20) 82075113 www.sgs.com.cn
中国·广州·经济技术开发区科学城科珠路198号 邮编: 510663 t (86-20) 82155555 f (86-20) 82075113 e sgs.china@sgs.com

Test Report

No. CANEC1503047702

Date: 13 Mar 2015

Page 4 of 13

<u>Test Item(s)</u>	<u>CAS NO.</u>	<u>Unit</u>	<u>MDL</u>	<u>002</u>
Naphthalene(NAP)	91-20-3	mg/kg	0.1	ND
Acenaphthylene(ANY)	208-96-8	mg/kg	0.1	ND
Acenaphthene(ANA)	83-32-9	mg/kg	0.1	ND
Fluorene(FLU)	86-73-7	mg/kg	0.1	ND
Phenanthrene(PHE)	85-01-8	mg/kg	0.1	ND
Anthracene(ANT)	120-12-7	mg/kg	0.1	ND
Fluoranthene(FLT)	206-44-0	mg/kg	0.1	ND
Pyrene(PYR)	129-00-0	mg/kg	0.1	ND
Benzo(a)anthracene(BaA)	56-55-3	mg/kg	0.1	ND
Chrysene(CHR)	218-01-9	mg/kg	0.1	ND
Benzo(b)fluoranthene(BbF) + Benzo(j)fluoranthene(BjF)	205-99-2/205-82-3	mg/kg	0.1	ND
Benzo(k)fluoranthene(BkF)	207-08-9	mg/kg	0.1	ND
Benzo(e)pyrene(BeP)	192-97-2	mg/kg	0.1	ND
Benzo(a)pyrene(BaP)	50-32-8	mg/kg	0.1	ND
Indeno(1,2,3-c,d)pyrene(IPY)	193-39-5	mg/kg	0.1	ND
Dibenzo(a,h)anthracene(DBA)	53-70-3	mg/kg	0.1	ND
Benzo(g,h,i)perylene(BPE)	191-24-2	mg/kg	0.1	ND
Sum of 18 PAHs		mg/kg	-	ND



This document is issued by the Company subject to its General Conditions of Service printed overleaf, available on request or accessible at <http://www.sgs.com/en/Terms-and-Conditions.aspx> and, for electronic format documents, subject to Terms and Conditions for Electronic Documents at <http://www.sgs.com/en/Terms-and-Conditions/Terms-e-Documents.aspx>. Attention is drawn to the limitation of liability, indemnification and jurisdiction issues defined therein. Any holder of this document is advised that information contained hereon reflects the Company's findings at the time of its intervention only and within the limits of Client's instructions, if any. The Company's sole responsibility is to its Client and this document does not exonerate parties to a transaction from exercising all their rights and obligations under the transaction documents. This document cannot be reproduced except in full, without prior written approval of the Company. Any unauthorized alteration, forgery or falsification of the content or appearance of this document is unlawful and offenders may be prosecuted to the fullest extent of the law. Unless otherwise stated the results shown in this test report refer only to the sample(s) tested.

Attention: To check the authenticity of testing /inspection report & certificate, please contact us at telephone: (86-755) 8307 1443, or email: CN.Doccheck@sgs.com

Note 1: ZEK 01.4-08: Restraining maximum values for products

Parameter	Category 1	Category 2	Category 3
	Material indented to be put in the mouth or material for toys with normal skin contact for children aged < 36 months	Materials those are not included in Category 1, with predictable contact with the skin longer than 30 s. (long-term skin contact)	Materials those are not included in Category 1 or 2, with predictable skin contact up to 30 s (short-term skin contact).
Benzo[a]pyrene (mg/kg)	Not detectable (<0.2)***	1	20
Sum of 18 PAH (mg/kg)**	Not detectable (<0.2)***	10	200

** = Only PAH substances >0.1 mg/kg are taken into account while calculating the sum of PAHs
 *** = In case that the maximum values exceed the limits of category 1, but are within the limits of category 2, one may confirm the suitability of the tested material which is indented to be put in the mouth by additional specific migration tests of PAH components based on DIN EN 1186ff and §64 LFGB 80.3. The conclusion of the migration test results must be made based on food law criteria.

Phthalate

Test Method : With reference to EN14372: 2004. Analysis was performed by GC-MS.

Test Item(s)	CAS NO.	Unit	MDL	002
Dibutyl Phthalate (DBP)	84-74-2	%(w/w)	0.003	ND
Benzylbutyl Phthalate (BBP)	85-68-7	%(w/w)	0.003	ND
Bis(2-ethylhexyl) Phthalate (DEHP)	117-81-7	%(w/w)	0.003	ND
Diisononyl Phthalate (DINP)	28553-12-0 / 68515-48-0	%(w/w)	0.010	ND
Di-n-octyl Phthalate (DNOP)	117-84-0	%(w/w)	0.003	ND



This document is issued by the Company subject to its General Conditions of Service printed overleaf, available on request or accessible at <http://www.sgs.com/en/Terms-and-Conditions.aspx> and, for electronic format documents, subject to Terms and Conditions for Electronic Documents at <http://www.sgs.com/en/Terms-and-Conditions/Terms-e-Documents.aspx>. Attention is drawn to the limitation of liability, indemnification and jurisdiction issues defined therein. Any holder of this document is advised that information contained hereon reflects the Company's findings at the time of its intervention only and within the limits of Client's instructions, if any. The Company's sole responsibility is to its Client and this document does not exonerate parties to a transaction from exercising all their rights and obligations under the transaction documents. This document cannot be reproduced except in full, without prior written approval of the Company. Any unauthorized alteration, forgery or falsification of the content or appearance of this document is unlawful and offenders may be prosecuted to the fullest extent of the law. Unless otherwise stated the results shown in this test report refer only to the sample(s) tested.

Attention: To check the authenticity of testing /inspection report & certificate, please contact us at telephone: (86-755) 8307 1443, or email: CN.Doccheck@sgs.com

198 Kezhu Road, Sciencetech Park Guangzhou Economic & Technology Development District, Guangzhou, China 510663 t (86-20) 82155555 f (86-20) 82075113 www.sgsgroup.com.cn
 中国·广州·经济技术开发区科学城科珠路198号 邮编: 510663 t (86-20) 82155555 f (86-20) 82075113 e sgs.china@sgs.com

Test Report

No. CANEC1503047702

Date: 13 Mar 2015

Page 6 of 13

<u>Test Item(s)</u>	<u>CAS NO.</u>	<u>Unit</u>	<u>MDL</u>	<u>002</u>
Diisodecyl Phthalate (DIDP)	26761-40-0 / 68515-49-1	%(w/w)	0.010	ND
Dimethyl Phthalate (DMP)	131-11-3	%(w/w)	0.003	ND
Diethyl Phthalate (DEP)	84-66-2	%(w/w)	0.003	ND
Diisobutyl Phthalate (DIBP)	84-69-5	%(w/w)	0.003	ND
Dinonyl Phthalate (DNP)	84-76-4	%(w/w)	0.003	ND
Diisooctyl Phthalate (DIOP)	27554-26-3	%(w/w)	0.010	ND
Dipropyl Phthalate (DPrP)	131-16-8	%(w/w)	0.003	ND
Dicyclohexyl Phthalate (DCHP)	84-61-7	%(w/w)	0.003	ND
Di-n-pentyl Phthalate (DnPP)	131-18-0	%(w/w)	0.003	ND
Dibenzyl Phthalate (DBzP)	523-31-9	%(w/w)	0.003	ND
Diphenyl Phthalate (DPhP)	84-62-8	%(w/w)	0.003	ND
Di-n-hexyl Phthalate (DnHP)	84-75-3	%(w/w)	0.003	ND

Notes :

- (1)DBP,BBP,DEHP Reference information: Entry 51 of Regulation (EC) No 552/2009 amending Annex XVII of REACH Regulation (EC) No 1907/2006 (previously restricted under Directive 2005/84/EC):
- i) Shall not be used as substances or in mixtures, in concentrations greater than 0.1 % by weight of the plasticised material, in toys and childcare articles.



This document is issued by the Company subject to its General Conditions of Service printed overleaf, available on request or accessible at <http://www.sgs.com/en/Terms-and-Conditions.aspx> and, for electronic format documents, subject to Terms and Conditions for Electronic Documents at <http://www.sgs.com/en/Terms-and-Conditions/Terms-e-Documents.aspx>. Attention is drawn to the limitation of liability, indemnification and jurisdiction issues defined therein. Any holder of this document is advised that information contained hereon reflects the Company's findings at the time of its intervention only and within the limits of Client's instructions, if any. The Company's sole responsibility is to its Client and this document does not exonerate parties to a transaction from exercising all their rights and obligations under the transaction documents. This document cannot be reproduced except in full, without prior written approval of the Company. Any unauthorized alteration, forgery or falsification of the content or appearance of this document is unlawful and offenders may be prosecuted to the fullest extent of the law. Unless otherwise stated the results shown in this test report refer only to the sample(s) tested.

Attention: To check the authenticity of testing /inspection report & certificate, please contact us at telephone: (86-755) 8307 1443, or email: CN.Doccheck@sgs.com

ii) Toys and childcare articles containing these phthalates in a concentration greater than 0.1 % by weight of the plasticised material shall not be placed on the market.

Please refer to Regulation (EC) No 552/2009 to get more detail information

(2) DINP, DNOP, DIDP Reference information: Entry 52 of Regulation (EC) No 552/2009 amending Annex XVII of REACH Regulation (EC) No 1907/2006 (previously restricted under Directive 2005/84/EC).

i) Shall not be used as substances or in mixtures, in concentrations greater than 0.1 % by weight of the plasticised material, in toys and childcare articles which can be placed in the mouth by children.

ii) Such toys and childcare articles containing these phthalates in a concentration greater than 0.1 % by weight of the plasticised material shall not be placed on the market.

Please refer to Regulation (EC) No 552/2009 to get more detail information



This document is issued by the Company subject to its General Conditions of Service printed overleaf, available on request or accessible at <http://www.sgs.com/en/Terms-and-Conditions.aspx> and, for electronic format documents, subject to Terms and Conditions for Electronic Documents at <http://www.sgs.com/en/Terms-and-Conditions/Terms-e-Documents.aspx>. Attention is drawn to the limitation of liability, indemnification and jurisdiction issues defined therein. Any holder of this document is advised that information contained hereon reflects the Company's findings at the time of its intervention only and within the limits of Client's instructions, if any. The Company's sole responsibility is to its Client and this document does not exonerate parties to a transaction from exercising all their rights and obligations under the transaction documents. This document cannot be reproduced except in full, without prior written approval of the Company. Any unauthorized alteration, forgery or falsification of the content or appearance of this document is unlawful and offenders may be prosecuted to the fullest extent of the law. Unless otherwise stated the results shown in this test report refer only to the sample(s) tested.

Attention: To check the authenticity of testing / inspection report & certificate, please contact us at telephone: (86-755) 8307 1443, or email: CN.Doccheck@sgs.com

ATTACHMENTS

RoHS Testing Flow Chart

- 1) Name of the person who made testing: Bruce Xiao / Sunny Hu
- 2) Name of the person in charge of testing: Bella Wang / Cutey Yu
- 3) These samples were dissolved totally by pre -conditioning method according to below flow chart (Cr⁶⁺ and PBBs/PBDEs test method excluded).

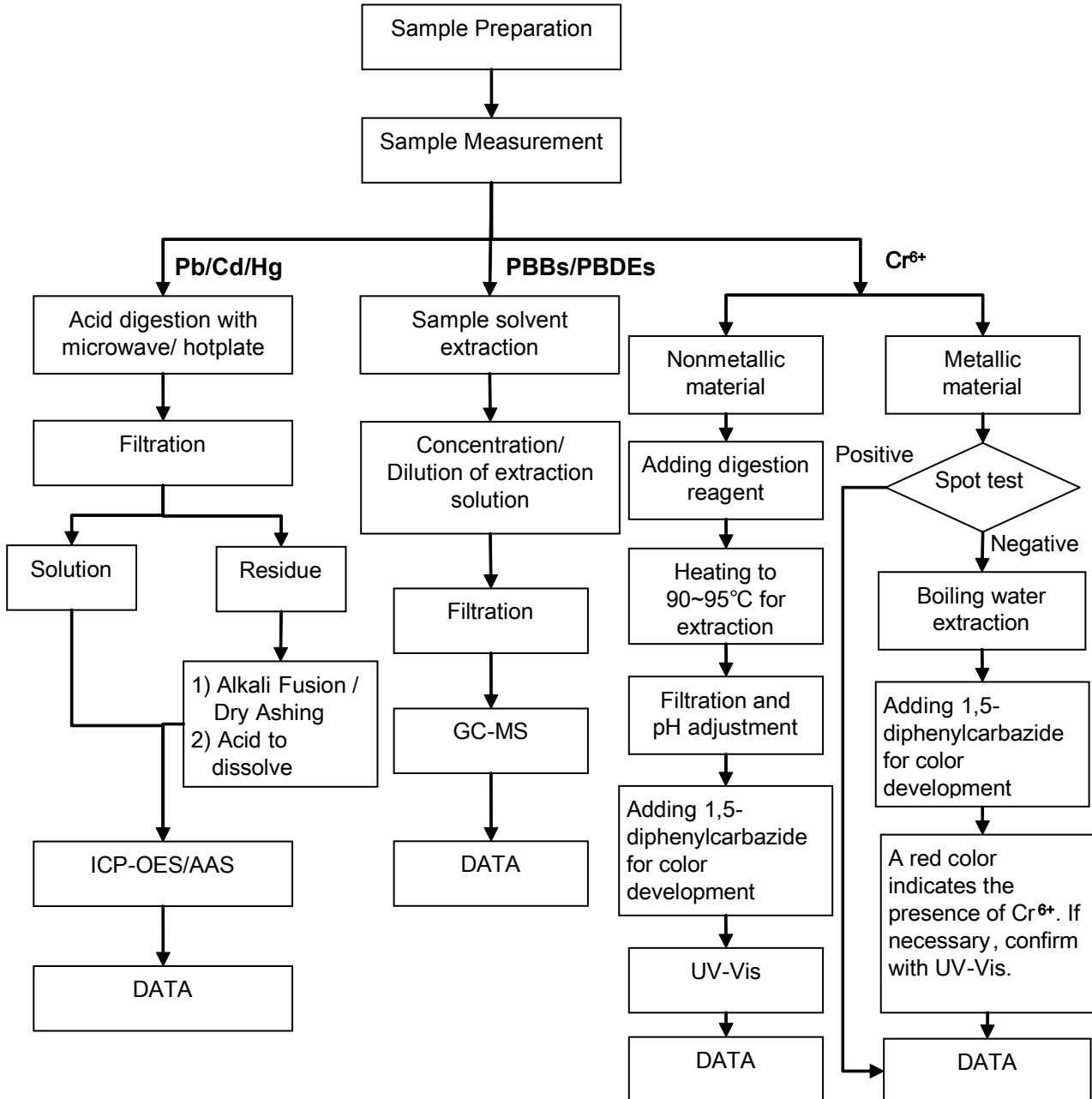

This document is issued by the Company subject to its General Conditions of Service printed overleaf, available on request or accessible at <http://www.sgs.com/en/Terms-and-Conditions.aspx> and, for electronic format documents, subject to Terms and Conditions for Electronic Documents at <http://www.sgs.com/en/Terms-and-Conditions/Terms-e-Documents.aspx>. Attention is drawn to the limitation of liability, indemnification and jurisdiction issues defined therein. Any holder of this document is advised that information contained hereon reflects the Company's findings at the time of its intervention only and within the limits of Client's instructions, if any. The Company's sole responsibility is to its Client and this document does not exonerate parties to a transaction from exercising all their rights and obligations under the transaction documents. This document cannot be reproduced except in full, without prior written approval of the Company. Any unauthorized alteration, forgery or falsification of the content or appearance of this document is unlawful and offenders may be prosecuted to the fullest extent of the law. Unless otherwise stated the results shown in this test report refer only to the sample(s) tested.

Attention: To check the authenticity of testing /inspection report & certificate, please contact us at telephone: (86-755) 8307 1443, or email: CN.Doccheck@sgs.com

198 Kezhu Road, Sciencetech Park Guangzhou Economic & Technology Development District, Guangzhou, China 510663 t (86-20) 82155555 f (86-20) 82075113 www.sgs.com.cn
中国·广州·经济技术开发区科学城科珠路198号 邮编: 510663 t (86-20) 82155555 f (86-20) 82075113 e sgs.china@sgs.com

ATTACHMENTS

Phthalates Testing Flow Chart

- 1) Name of the person who made testing: Sunny Hu
- 2) Name of the person in charge of testing: Cutey Yu

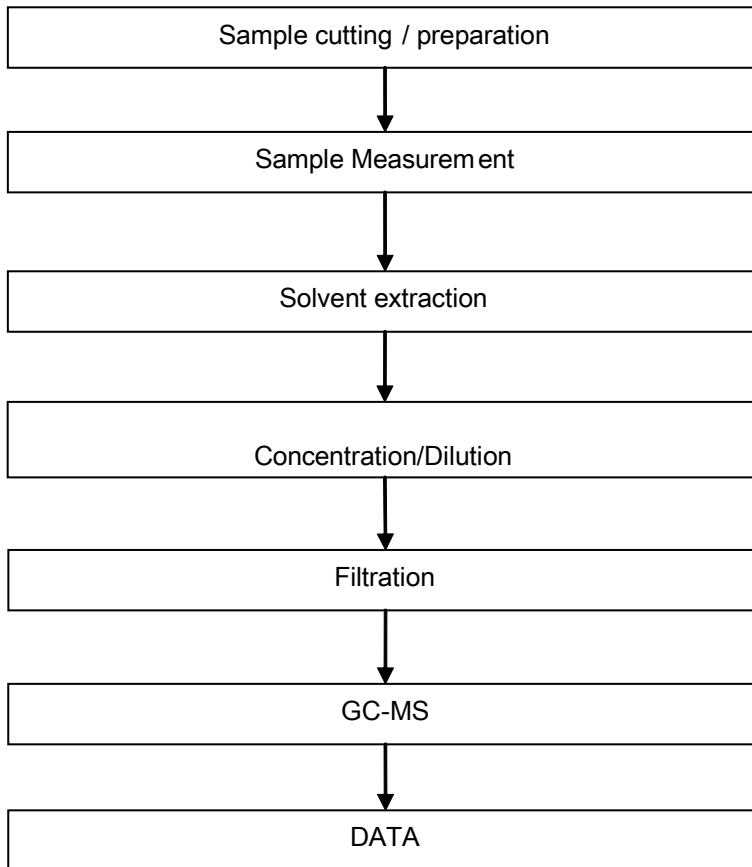

This document is issued by the Company subject to its General Conditions of Service printed overleaf, available on request or accessible at <http://www.sgs.com/en/Terms-and-Conditions.aspx> and, for electronic format documents, subject to Terms and Conditions for Electronic Documents at <http://www.sgs.com/en/Terms-and-Conditions/Terms-e-Documents.aspx>. Attention is drawn to the limitation of liability, indemnification and jurisdiction issues defined therein. Any holder of this document is advised that information contained hereon reflects the Company's findings at the time of its intervention only and within the limits of Client's instructions, if any. The Company's sole responsibility is to its Client and this document does not exonerate parties to a transaction from exercising all their rights and obligations under the transaction documents. This document cannot be reproduced except in full, without prior written approval of the Company. Any unauthorized alteration, forgery or falsification of the content or appearance of this document is unlawful and offenders may be prosecuted to the fullest extent of the law. Unless otherwise stated the results shown in this test report refer only to the sample(s) tested.

Attention: To check the authenticity of testing / inspection report & certificate, please contact us at telephone: (86-755) 8307 1443, or email: CN.Doccheck@sgs.com

ATTACHMENTS

PAHs Testing Flow Chart

- 1) Name of the person who made testing: Sunny Hu
- 2) Name of the person in charge of testing: Cutey Yu

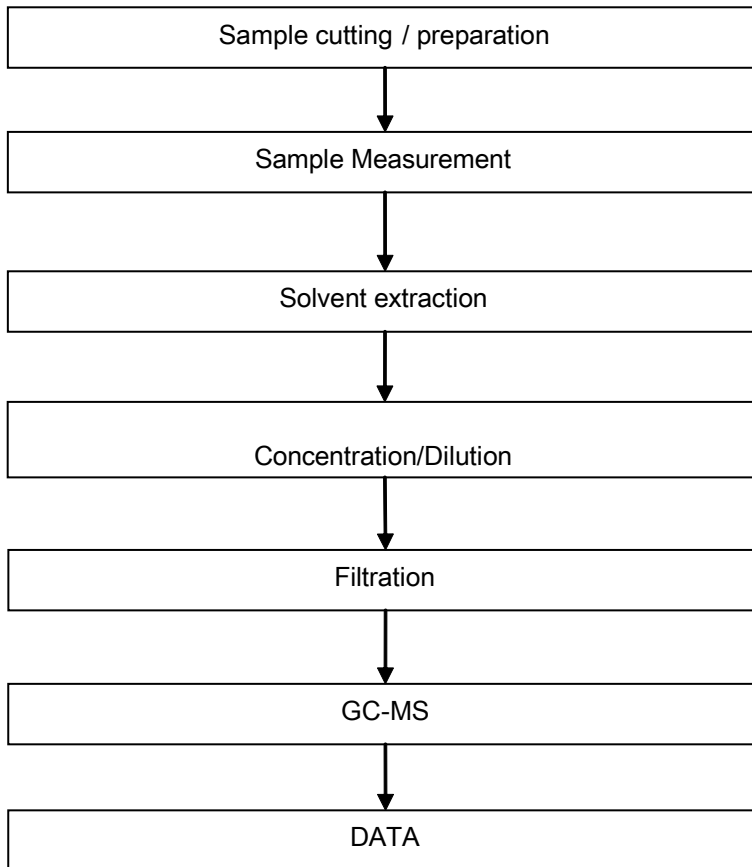

This document is issued by the Company subject to its General Conditions of Service printed overleaf, available on request or accessible at <http://www.sgs.com/en/Terms-and-Conditions.aspx> and, for electronic format documents, subject to Terms and Conditions for Electronic Documents at <http://www.sgs.com/en/Terms-and-Conditions/Terms-e-Documents.aspx>. Attention is drawn to the limitation of liability, indemnification and jurisdiction issues defined therein. Any holder of this document is advised that information contained hereon reflects the Company's findings at the time of its intervention only and within the limits of Client's instructions, if any. The Company's sole responsibility is to its Client and this document does not exonerate parties to a transaction from exercising all their rights and obligations under the transaction documents. This document cannot be reproduced except in full, without prior written approval of the Company. Any unauthorized alteration, forgery or falsification of the content or appearance of this document is unlawful and offenders may be prosecuted to the fullest extent of the law. Unless otherwise stated the results shown in this test report refer only to the sample(s) tested.

Attention: To check the authenticity of testing /inspection report & certificate, please contact us at telephone: (86-755) 8307 1443, or email: CN.Doccheck@sgs.com

198 Kezhu Road, Sciencetech Park Guangzhou Economic & Technology Development District, Guangzhou, China 510663 t (86-20) 82155555 f (86-20) 82075113 www.sgsgroup.com.cn
 中国·广州·经济技术开发区科学城科珠路198号 邮编: 510663 t (86-20) 82155555 f (86-20) 82075113 e sgs.china@sgs.com

ATTACHMENTS

Halogen Testing Flow Chart

- 1) Name of the person who made testing: Hanming Xiao
- 2) Name of the person in charge of testing: Bella Wang

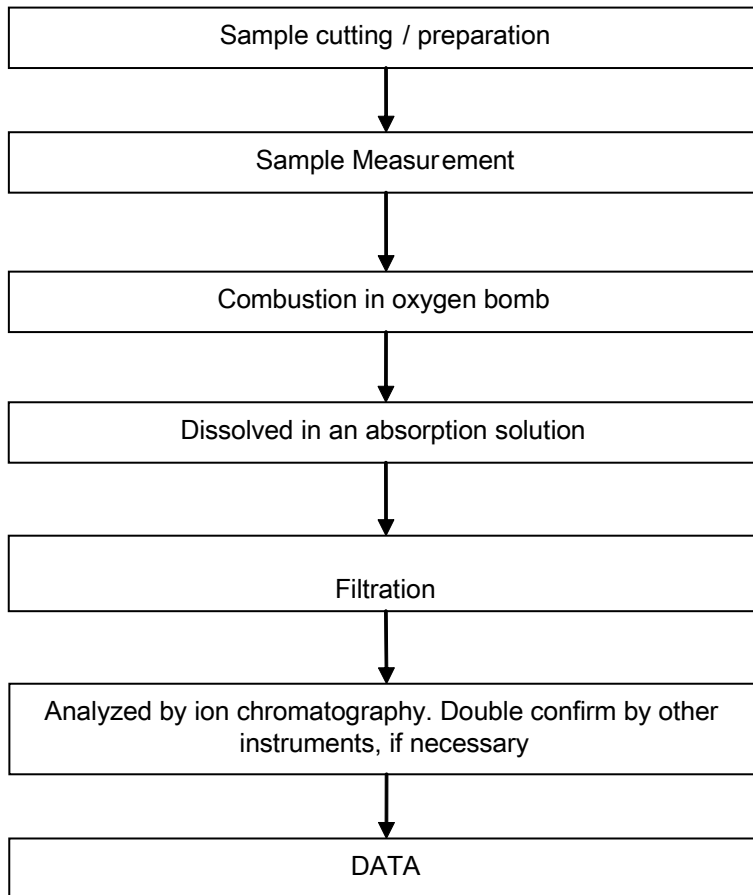

This document is issued by the Company subject to its General Conditions of Service printed overleaf, available on request or accessible at <http://www.sgs.com/en/Terms-and-Conditions.aspx> and, for electronic format documents, subject to Terms and Conditions for Electronic Documents at <http://www.sgs.com/en/Terms-and-Conditions/Terms-e-Documents.aspx>. Attention is drawn to the limitation of liability, indemnification and jurisdiction issues defined therein. Any holder of this document is advised that information contained hereon reflects the Company's findings at the time of its intervention only and within the limits of Client's instructions, if any. The Company's sole responsibility is to its Client and this document does not exonerate parties to a transaction from exercising all their rights and obligations under the transaction documents. This document cannot be reproduced except in full, without prior written approval of the Company. Any unauthorized alteration, forgery or falsification of the content or appearance of this document is unlawful and offenders may be prosecuted to the fullest extent of the law. Unless otherwise stated the results shown in this test report refer only to the sample(s) tested.

Attention: To check the authenticity of testing / inspection report & certificate, please contact us at telephone: (86-755) 8307 1443, or email: CN.Doccheck@sgs.com

ATTACHMENTS

Elementary Testing Flow Chart

- 1) Name of the person who made testing : Bruce Xiao
- 2) Name of the person in charge of testing : Bella Wang

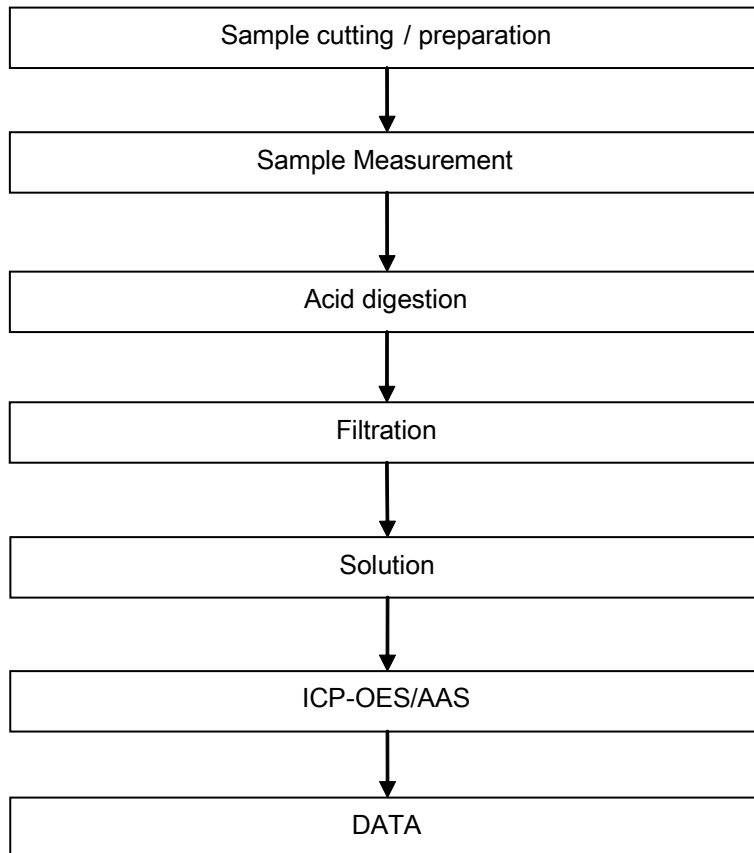

This document is issued by the Company subject to its General Conditions of Service printed overleaf, available on request or accessible at <http://www.sgs.com/en/Terms-and-Conditions.aspx> and, for electronic format documents, subject to Terms and Conditions for Electronic Documents at <http://www.sgs.com/en/Terms-and-Conditions/Terms-e-Documents.aspx>. Attention is drawn to the limitation of liability, indemnification and jurisdiction issues defined therein. Any holder of this document is advised that information contained hereon reflects the Company's findings at the time of its intervention only and within the limits of Client's instructions, if any. The Company's sole responsibility is to its Client and this document does not exonerate parties to a transaction from exercising all their rights and obligations under the transaction documents. This document cannot be reproduced except in full, without prior written approval of the Company. Any unauthorized alteration, forgery or falsification of the content or appearance of this document is unlawful and offenders may be prosecuted to the fullest extent of the law. Unless otherwise stated the results shown in this test report refer only to the sample(s) tested.

Attention: To check the authenticity of testing / inspection report & certificate, please contact us at telephone: (86-755) 8307 1443, or email: CN.Doccheck@sgs.com

198 Kezhu Road, Sciencetech Park Guangzhou Economic & Technology Development District, Guangzhou, China 510663 t (86-20) 82155555 f (86-20) 82075113 www.sgsgroup.com.cn
中国·广州·经济技术开发区科学城科珠路198号 邮编: 510663 t (86-20) 82155555 f (86-20) 82075113 e sgs.china@sgs.com

Sample photo:



SGS authenticate the photo on original report only

*** End of Report ***

Test Report

No. CANML1500460601

Date: 14 Jan 2015

Page 1 of 4

GUANGDONG XINGFA ALUMINIUM CO., LTD

RENGHE ROAD 23#,NANZHUANG TOWN,CHANGCHENG DISTRICT,FOSHAN CITY,GUANGDONG PROVINCE,CHINA

The following sample(s) was/were submitted and identified on behalf of the clients as :
6063-T5 Aluminium alloy profiles

SGS Job No. : GZIN1501001229PC - GZ

Internal Reference No. : GZIN1501001119ML

Date of Sample Received : 09 Jan 2015

Testing Period : 09 Jan 2015 - 14 Jan 2015

Test Requested : Selected test(s) as requested by client.

Test Method : Please refer to next page(s).

Test Results : Please refer to next page(s).

Conclusion : Based on the performed tests on submitted sample(s), the results of Lead, Mercury, Cadmium, Hexavalent chromium comply with the limits as set by RoHS Directive 2011/65/EU Annex II; recasting 2002/95/EC.

Signed for and on behalf of
SGS-CSTC Ltd.

Echo

Echo Yeung
Approved Signatory



This document is issued by the Company subject to its General Conditions of Service printed overleaf, available on request or accessible at <http://www.sgs.com/en/Terms-and-Conditions.aspx> and, for electronic format documents, subject to Terms and Conditions for Electronic Documents at <http://www.sgs.com/en/Terms-and-Conditions/Terms-e-Documents.aspx>. Attention is drawn to the limitation of liability, indemnification and jurisdiction issues defined therein. Any holder of this document is advised that information contained hereon reflects the Company's findings at the time of its intervention only and within the limits of Client's instructions, if any. The Company's sole responsibility is to its Client and this document does not exonerate parties to a transaction from exercising all their rights and obligations under the transaction documents. This document cannot be reproduced except in full, without prior written approval of the Company. Any unauthorized alteration, forgery or falsification of the content or appearance of this document is unlawful and offenders may be prosecuted to the fullest extent of the law. Unless otherwise stated the results shown in this test report refer only to the sample(s) tested.

Attention: To check the authenticity of testing inspection report & certificate, please contact us at telephone: (86-755) 6387 1443, or email: CN.Doccheck@sgs.com

198 Kiehu Road, Solartech Park Guangzhou Economic & Technology Development District, Guangzhou, China 510663 | (86-20) 82155555 | (86-20) 82075113 | www.sgs.com
中国·广州·经济技术开发区科学城科珠路198号 邮编: 510663 | (86-20) 82155555 | (86-20) 82075113 | sgs.china@sgs.com

Test Report

No. CANML1500460601

Date: 14 Jan 2015

Page 2 of 4

Test Results :

Test Part Description :

Specimen No.	SGS Sample ID	Description
SN1	CAN15-004606.001	Silvery metal

Remarks :

- (1) 1 mg/kg = 1 ppm = 0.0001%
- (2) MDL = Method Detection Limit
- (3) ND = Not Detected (< MDL)
- (4) "-" = Not Regulated

RoHS Directive 2011/65/EU

Test Method : (1)With reference to IEC 62321-5:2013, determination of Cadmium by ICP-OES.
 (2)With reference to IEC 62321-5:2013, determination of Lead by ICP-OES.
 (3)With reference to IEC 62321-4:2013, determination of Mercury by ICP-OES.
 (4)With reference to IEC 62321:2008, determination of Hexavalent Chromium by spot test / Colorimetric Method using UV-Vis.

<u>Test Item(s)</u>	<u>Limit</u>	<u>Unit</u>	<u>MDL</u>	<u>001</u>
Cadmium (Cd)	100	mg/kg	2	ND
Lead (Pb)	1,000	mg/kg	2	ND
Mercury (Hg)	1,000	mg/kg	2	ND
Hexavalent Chromium (CrVI)	-	-	◇	Negative

Notes :

- (1) The maximum permissible limit is quoted from the directive 2011/65/EU, Annex II
- (2)◇Spot-test:
 Negative = Absence of CrVI coating, Positive = Presence of CrVI coating;
 (The tested sample should be further verified by boiling-water-extraction method if the spot test result is Negative or cannot be confirmed.)
- ◇Boiling-water-extraction:
 Negative = Absence of CrVI coating
 Positive = Presence of CrVI coating; the detected concentration in boiling-water-extraction solution is equal or greater than 0.02 mg/kg with 50 cm² sample surface area.
 Information on storage conditions and production date of the tested sample is unavailable and thus results of Cr(VI) represent status of the sample at the time of testing.



This document is issued by the Company subject to its General Conditions of Service printed overleaf, available on request or accessible at <http://www.sgs.com/en/terms-and-conditions.aspx> and, for electronic format documents, subject to Terms and Conditions for Electronic Documents at <http://www.sgs.com/en/terms-and-conditions/terms-e-document.aspx>. Attention is drawn to the limitation of liability, indemnification and jurisdiction issues defined therein. Any holder of this document is advised that information contained hereon reflects the Company's findings at the time of its intervention only and within the limits of Client's instructions, if any. The Company's sole responsibility is to its Client and this document does not exonerate parties to a transaction from exercising all their rights and obligations under the transaction documents. This document cannot be reproduced except in full, without prior written approval of the Company. Any unauthorized alteration, forgery or falsification of the content or appearance of this document is unlawful and offenders may be prosecuted to the fullest extent of the law. Unless otherwise stated the results shown in this test report refer only to the sample(s) tested.

Attention: To check the authenticity of testing inspection report & certificate, please contact us at telephone: (86-755) 8307 1443, or email: CN.Doccheck@sgs.com

198 Kaifu Road, Sciencetech Park Guangzhou Economic & Technology Development District, Guangzhou, China 510663 t (86-20) 82155555 f (86-20) 82075113 www.sgsgroup.com.cn
 中国·广州·经济技术开发区科学城科珠路198号 邮编: 510663 t (86-20) 82155555 f (86-20) 82075113 e sgs.china@sgs.com

ATTACHMENTS

RoHS Testing Flow Chart

- 1) Name of the person who made testing: Bruce Xiao
- 2) Name of the person in charge of testing: Bella Wang
- 3) These samples were dissolved totally by pre -conditioning method according to below flow chart (Cr6+ test method excluded).

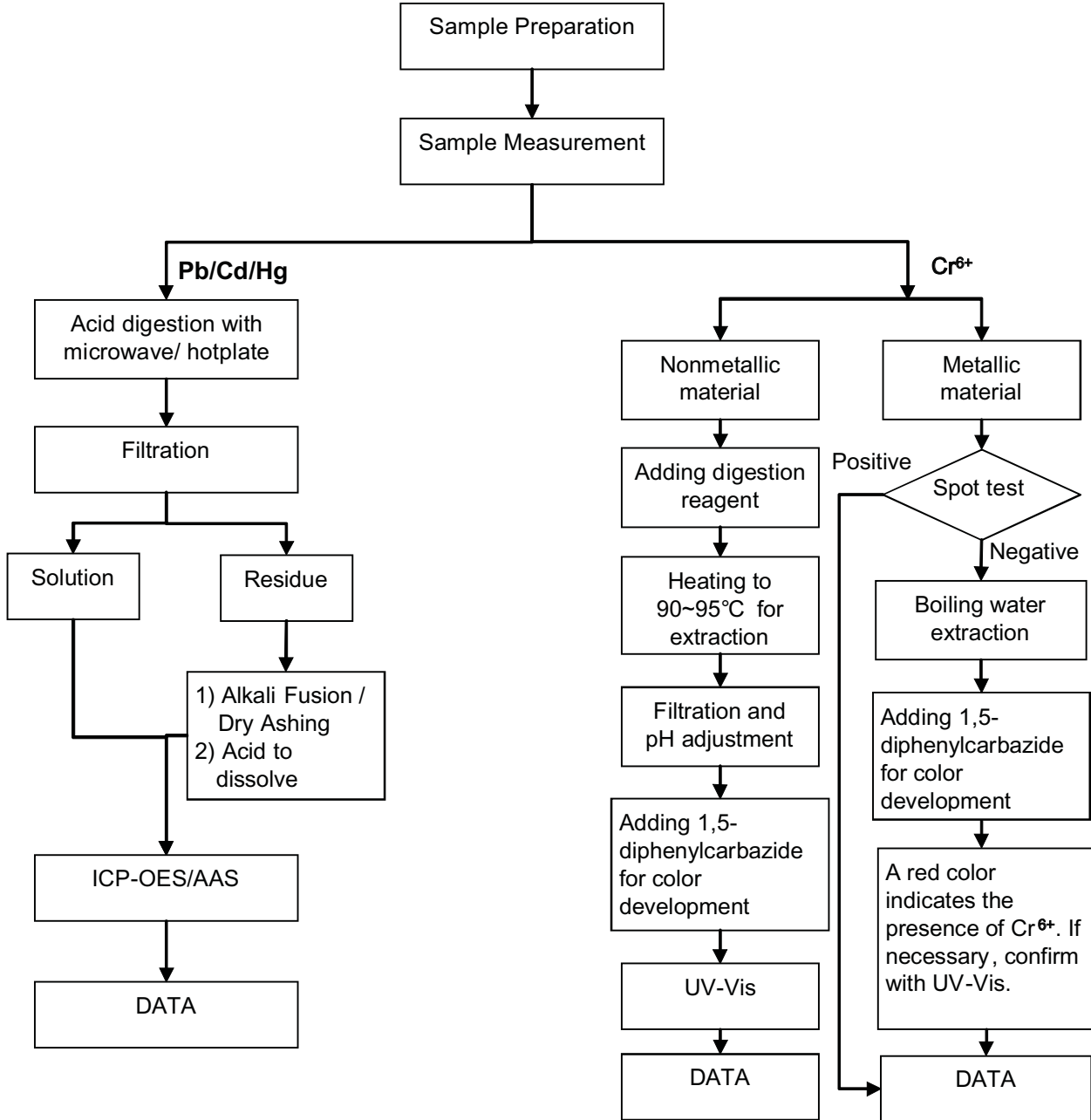

This document is issued by the Company subject to its General Conditions of Service printed overleaf, available on request or accessible at <http://www.sgs.com/en/terms-and-conditions.aspx> and, for electronic format documents, subject to Terms and Conditions for Electronic Documents at <http://www.sgs.com/en/terms-and-conditions/terms-e-document.aspx>. Attention is drawn to the limitation of liability, indemnification and jurisdiction issues defined therein. Any holder of this document is advised that information contained hereon reflects the Company's findings at the time of its intervention only and within the limits of Client's instructions, if any. The Company's sole responsibility is to its Client and this document does not exonerate parties to a transaction from exercising all their rights and obligations under the transaction documents. This document cannot be reproduced except in full, without prior written approval of the Company. Any unauthorized alteration, forgery or falsification of the content or appearance of this document is unlawful and offenders may be prosecuted to the fullest extent of the law. Unless otherwise stated the results shown in this test report refer only to the sample(s) tested.

Attention: To check the authenticity of testing/inspection report & certificate, please contact us at telephone: (86-755) 8307 1443, or email: CN.Doccheck@sgs.com

198 Kaifu Road, Solentech Park Guangzhou Economic & Technology Development District, Guangzhou, China 510663 | (86-20) 82155555 | (86-20) 82075113 | www.sgsgroup.com.cn
 中国·广州·经济技术开发区科学城科珠路198号 邮编: 510663 | (86-20) 82155555 | (86-20) 82075113 | e.sgs.china@sgs.com

Sample photo:

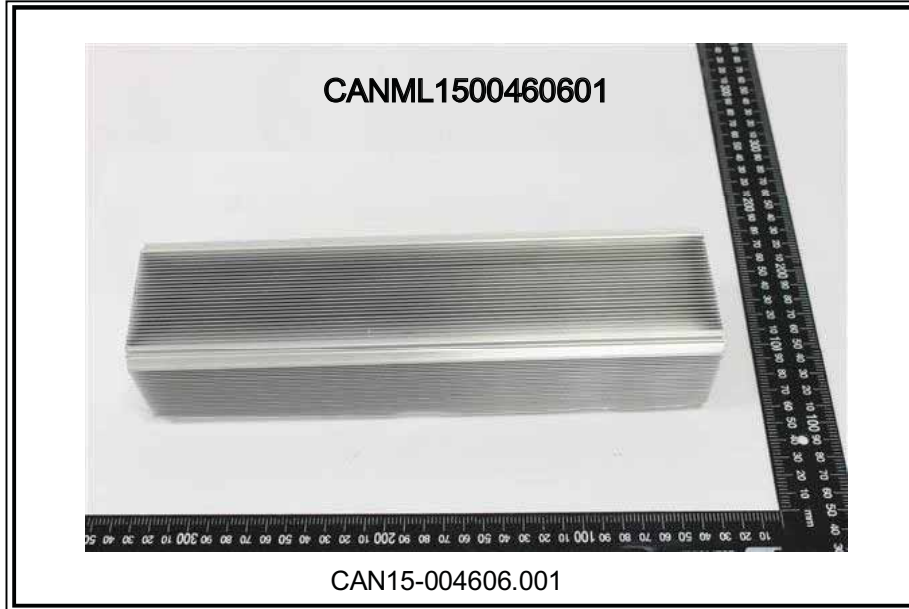

SGS authenticate the photo on original report only

*** End of Report ***

01-March-2010

Dear Valued Customer,

[Subject: Status of our products with respect to RoHS Directive 2002/95/EC \(and its amendments\)](#)

Thank you for using SABIC INNOVATIVE PLASTICS' products.

With reference to your request for the information regarding status of our Products with respect to the RoHS Directive 2002/95/EC (and its amendments), SABIC INNOVATIVE PLASTICS can provide following information:

The CYCOLAC*, CYCOLOY*, EXTEM*, GELOY*, LEXAN*, NORYL*, NORYL GTX*, NORYL PPX*, ULTEM*, VALOX*, XENOY*, XYLEX* resins and, COLORCOMP*, FARADEx*, KONDUIT*, LUBRICOMP*, LUBRILOY*, STARAMIDE* STARFLAM*, STAT-KON*, STAT-LOY*, THERMOCOMP*, THERMOTUF*, VERTON* compounds [all existing grade-colors, except those which are designed to consume Post Consumer Recycle (PCR)] do not contain any chemicals listed below as intentionally added components or as expected process impurities [above threshold limits of 0.1% for Lead, Mercury, Hexavalent Chromium, PBB and PBDE, and 0.01% for Cadmium]

- Cadmium and its compounds
- Lead and its compounds
- Mercury and its compounds
- Hexavalent Chromium compounds
- Polybrominated biphenyls (PBBs)
- Polybrominated diphenyl ethers (PBDEs including Deca-BDE)

Please note that analysis of the raw materials and/or finished goods for presence of the above mentioned substances on a routine basis is neither a part of our quality control plan, nor is a part of the SABIC-IP product specifications, and hence it should not be construed as any warranty, expressed or implied.

Please be informed that, certain SABIC-IP products are designed to consume PCR for environmental waste reduction. The details about use of the PCR, if any, are stated in the respective MSDS. Please contact our Customer Service or Product Stewardship team to request information regarding the chemical compliance attributes of these products, which may differ from those contained in this letter.

If you have any further questions, or you require any additional information, please contact: gopal.majmudar@SABIC-IP.com (Phone: +91 265 3068501) or chris.wu@sabic-ip.com (Phone: +86 20 38488383 3003)

Sincerely,



Gregory Porta, Ph.D.
for SABIC Innovative Plastics

Encl: Nil

<p>Gregory Porta, Ph.D. Director-Product Stewardship & Toxicology</p> <p>T: 1-304-863-7594 F: 1-304-863-7693 E: greg.porta@sabic-ip.com</p>	<p>ANY SALE OF PRODUCTS OR DELIVERY OF CUSTOMER SUPPORT AND ADVICE BY SABIC INNOVATIVE PLASTICS HOLDING BV, ITS SUBSIDIARIES AND AFFILIATES ("SELLER"), IS MADE EXCLUSIVELY UNDER SELLER'S STANDARD CONDITIONS OF SALE which can be located at http://www.sabic-ip.com. SELLER MAKES NO WARRANTY, EXPRESS OR IMPLIED, WITH RESPECT TO THE PERFORMANCE, SUITABILITY OR FITNESS FOR INTENDED USE OF ITS PRODUCTS IN ANY CUSTOMER'S APPLICATION.</p> <p>Each customer should determine the suitability of SELLERS materials for the customer's particular use through appropriate testing and analysis.</p> <p>SABIC Innovative Plastics is a trademark of SABIC Holding Europe BV * Trademark of SABIC Innovative Plastics IP BV</p>
---	--

This version for the letter supersedes all previous versions of it on the same subject.

Test Report

No. CANEC1517788106

Date: 22 Oct 2015

Page 1 of 8

FOUR PILLARS INDUSTRIAL(SHENZHEN)CO.,LTD.

FOUR PILLARS TECHNOLOGIES & APPLIED MATERIALS(SHENZHEN)CO.,LTD.

FIRST AND SECOND BUILDING,THIRD INDUSTRIAL ZONE,FENGHUANG COUNTRY,FUYONG TOWN,BAOAN DISTRICT,SHENZHEN ,CHINA

The following sample(s) was/were submitted and identified on behalf of the clients as : Label

SGS Job No. : CP15-058194 - SZ

Lot No. : 40371004

Model No. : PO32AZ

Client Ref. Info. : PO32AZ, PO3BZ, PO3MAZ, PO3MZ, PO6BZ, PO6GZ, PO6LZ, PO6MZ, PO6NZ, PO6TZ, PO6WZ, PO72AZ, PO72BZ, PO72TZ, PO72Z, PO7MCZ, PO7YZ, PO7NZ, PO92Z, PO94AZ, PO9BHZ, PO9LZ, PO9MGZ, PO9MHZ, PO9MZ, PO9WZ,POBDZ,POBEZ,POBGZ,POBHZ,POBKZ, PO3BWZ, PO5MZ, PO9BZ, PO4MHZ, PO7YBZ

Manufacturer : FOUR PILLARS INDUSTRIAL(SHENZHEN)CO.,LTD.

FOUR PILLARS TECHNOLOGIES & APPLIED MATERIALS(SHENZHEN)CO.,LTD.

Manufacturer Address : FIRST AND SECOND BUILDING,THIRD INDUSTRIAL ZONE,FENGHUANG COUNTRY,FUYONG TOWN,BAOAN DISTRICT,SHENZHEN ,CHINA

Date of Sample Received : 19 Oct 2015

Testing Period : 19 Oct 2015 - 22 Oct 2015

Test Requested : Selected test(s) as requested by client.

Test Method : Please refer to next page(s).

Test Results : Please refer to next page(s).

Conclusion : Based on the performed tests on selected part of submitted sample(s), the results of Lead, Mercury, Cadmium, Hexavalent chromium, Polybrominated biphenyls (PBBs), Polybrominated diphenyl ethers (PBDEs) and Phthalates such as Bis(2-ethylhexyl) phthalate (DEHP) , Butyl benzyl phthalate (BBP), Dibutyl phthalate (DBP) , and Diisobutyl phthalate (DIBP) comply with the limits as set by RoHS Directive (EU) 2015/863 amending Annex II to Directive 2011/65/EU.



This document is issued by the Company subject to its General Conditions of Service printed overleaf, available on request or accessible at <http://www.sgs.com/en/Terms-and-Conditions.aspx> and, for electronic format documents, subject to Terms and Conditions for Electronic Documents at <http://www.sgs.com/en/Terms-and-Conditions/Terms-e-Document.aspx>. Attention is drawn to the limitation of liability, indemnification and jurisdiction issues defined therein. Any holder of this document is advised that information contained hereon reflects the Company's findings at the time of its intervention only and within the limits of Client's instructions, if any. The Company's sole responsibility is to its Client and this document does not exonerate parties to a transaction from exercising all their rights and obligations under the transaction documents. This document cannot be reproduced except in full, without prior written approval of the Company. Any unauthorized alteration, forgery or falsification of the content or appearance of this document is unlawful and offenders may be prosecuted to the fullest extent of the law. Unless otherwise stated the results shown in this test report refer only to the sample(s) tested.

Attention: To check the authenticity of testing /inspection report & certificate, please contact us at telephone: (86-755) 8307 1443, or email: CN.Doccheck@sgs.com

198 Kezhu Road, Sciencetech Park Guangzhou Economic & Technology Development District, Guangzhou, China 510663 t (86-20) 82155555 f (86-20) 82075113 www.sgs.com.cn
中国·广州·经济技术开发区科学城科珠路198号 邮编: 510663 t (86-20) 82155555 f (86-20) 82075113 e sgs.china@sgs.com

Test Report

No. CANEC1517788106

Date: 22 Oct 2015

Page 2 of 8

Signed for and on behalf of
SGS-CSTC Standards Technical Services Co., Ltd. Guangzhou Branch

Violet

Violet, Shi
Approved Signatory



This document is issued by the Company subject to its General Conditions of Service printed overleaf, available on request or accessible at <http://www.sgs.com/en/Terms-and-Conditions.aspx> and, for electronic format documents, subject to Terms and Conditions for Electronic Documents at <http://www.sgs.com/en/Terms-and-Conditions/Terms-e-Documents.aspx>. Attention is drawn to the limitation of liability, indemnification and jurisdiction issues defined therein. Any holder of this document is advised that information contained hereon reflects the Company's findings at the time of its intervention only and within the limits of Client's instructions, if any. The Company's sole responsibility is to its Client and this document does not exonerate parties to a transaction from exercising all their rights and obligations under the transaction documents. This document cannot be reproduced except in full, without prior written approval of the Company. Any unauthorized alteration, forgery or falsification of the content or appearance of this document is unlawful and offenders may be prosecuted to the fullest extent of the law. Unless otherwise stated the results shown in this test report refer only to the sample(s) tested.

Attention: To check the authenticity of testing /inspection report & certificate, please contact us at telephone: (86-755) 8307 1443, or email: CN.Doccheck@sgs.com

SGS-CSTC Standards Technical Services Co., Ltd.
Guangzhou Branch Standards Technical Services Co., Ltd. Chemical Laboratory

198 Kezhu Road, Sciencetech Park Guangzhou Economic & Technology Development District, Guangzhou, China 510663 t (86-20) 82155555 f (86-20) 82075113 www.sgsgroup.com.cn
中国·广州·经济技术开发区科学城科珠路198号 邮编: 510663 t (86-20) 82155555 f (86-20) 82075113 e sgs.china@sgs.com

Test Part Description :

Specimen No.	SGS Sample ID	Description
SN1	CAN15-177881.006	Silver-grey adhesive sheet

Remarks :

- (1) 1 mg/kg = 1 ppm = 0.0001%
- (2) MDL = Method Detection Limit
- (3) ND = Not Detected (< MDL)
- (4) "-" = Not Regulated

RoHS Directive (EU) 2015/863 amending Annex II to Directive 2011/65/EU

- Test Method :
- (1)With reference to IEC 62321-5:2013, determination of Cadmium by ICP-OES.
 - (2)With reference to IEC 62321-5:2013, determination of Lead by ICP-OES.
 - (3)With reference to IEC 62321-4:2013, determination of Mercury by ICP-OES.
 - (4)With reference to IEC 62321:2008, determination of Hexavalent Chromium by Colorimetric Method using UV-Vis.
 - (5)With reference to IEC 62321-6:2015, determination of PBBs and PBDEs by GC-MS.
 - (6)With reference to EN 14372:2004, determination of phthalates by GC-MS.

<u>Test Item(s)</u>	<u>Limit</u>	<u>Unit</u>	<u>MDL</u>	<u>006</u>
Cadmium (Cd)	100	mg/kg	2	ND
Lead (Pb)	1,000	mg/kg	2	ND
Mercury (Hg)	1,000	mg/kg	2	ND
Hexavalent Chromium (CrVI)	1,000	mg/kg	2	ND
Sum of PBBs	1,000	mg/kg	-	ND
Monobromobiphenyl	-	mg/kg	5	ND
Dibromobiphenyl	-	mg/kg	5	ND
Tribromobiphenyl	-	mg/kg	5	ND
Tetrabromobiphenyl	-	mg/kg	5	ND
Pentabromobiphenyl	-	mg/kg	5	ND
Hexabromobiphenyl	-	mg/kg	5	ND
Heptabromobiphenyl	-	mg/kg	5	ND
Octabromobiphenyl	-	mg/kg	5	ND
Nonabromobiphenyl	-	mg/kg	5	ND
Decabromobiphenyl	-	mg/kg	5	ND
Sum of PBDEs	1,000	mg/kg	-	ND
Monobromodiphenyl ether	-	mg/kg	5	ND



This document is issued by the Company subject to its General Conditions of Service printed overleaf, available on request or accessible at <http://www.sgs.com/en/Terms-and-Conditions.aspx> and, for electronic format documents, subject to Terms and Conditions for Electronic Documents at <http://www.sgs.com/en/Terms-and-Conditions/Terms-e-Documents.aspx>. Attention is drawn to the limitation of liability, indemnification and jurisdiction issues defined therein. Any holder of this document is advised that information contained hereon reflects the Company's findings at the time of its intervention only and within the limits of Client's instructions, if any. The Company's sole responsibility is to its Client and this document does not exonerate parties to a transaction from exercising all their rights and obligations under the transaction documents. This document cannot be reproduced except in full, without prior written approval of the Company. Any unauthorized alteration, forgery or falsification of the content or appearance of this document is unlawful and offenders may be prosecuted to the fullest extent of the law. Unless otherwise stated the results shown in this test report refer only to the sample(s) tested.

Attention: To check the authenticity of testing /inspection report & certificate, please contact us at telephone: (86-755) 8307 1443, or email: CN.Doccheck@sgs.com

Test Report

No. CANEC1517788106

Date: 22 Oct 2015

Page 4 of 8

<u>Test Item(s)</u>	<u>Limit</u>	<u>Unit</u>	<u>MDL</u>	<u>006</u>
Dibromodiphenyl ether	-	mg/kg	5	ND
Tribromodiphenyl ether	-	mg/kg	5	ND
Tetrabromodiphenyl ether	-	mg/kg	5	ND
Pentabromodiphenyl ether	-	mg/kg	5	ND
Hexabromodiphenyl ether	-	mg/kg	5	ND
Heptabromodiphenyl ether	-	mg/kg	5	ND
Octabromodiphenyl ether	-	mg/kg	5	ND
Nonabromodiphenyl ether	-	mg/kg	5	ND
Decabromodiphenyl ether	-	mg/kg	5	ND
Dibutyl phthalate (DBP)	1,000	mg/kg	30	ND
Butyl benzyl phthalate (BBP)	1,000	mg/kg	30	ND
Bis (2-ethylhexyl) phthalate (DEHP)	1,000	mg/kg	30	ND
Diisobutyl Phthalates (DIBP)	1,000	mg/kg	30	ND

Notes :

(1) The maximum permissible limit is quoted from RoHS Directive (EU) 2015/863.

Halogen

Test Method : With reference to EN 14582: 2007, analysis was performed by Ion Chromatograph (IC).

<u>Test Item(s)</u>	<u>Unit</u>	<u>MDL</u>	<u>006</u>
Fluorine (F)	mg/kg	50	ND
Chlorine (Cl)	mg/kg	50	ND
Bromine (Br)	mg/kg	50	ND
Iodine (I)	mg/kg	50	ND



This document is issued by the Company subject to its General Conditions of Service printed overleaf, available on request or accessible at <http://www.sgs.com/en/Terms-and-Conditions.aspx> and, for electronic format documents, subject to Terms and Conditions for Electronic Documents at <http://www.sgs.com/en/Terms-and-Conditions/Terms-e-Documents.aspx>. Attention is drawn to the limitation of liability, indemnification and jurisdiction issues defined therein. Any holder of this document is advised that information contained hereon reflects the Company's findings at the time of its intervention only and within the limits of Client's instructions, if any. The Company's sole responsibility is to its Client and this document does not exonerate parties to a transaction from exercising all their rights and obligations under the transaction documents. This document cannot be reproduced except in full, without prior written approval of the Company. Any unauthorized alteration, forgery or falsification of the content or appearance of this document is unlawful and offenders may be prosecuted to the fullest extent of the law. Unless otherwise stated the results shown in this test report refer only to the sample(s) tested.

Attention: To check the authenticity of testing /inspection report & certificate, please contact us at telephone: (86-755) 8307 1443, or email: CN.Doccheck@sgs.com

SGS-CTD Standards Technical Services Co., Ltd.
Guangzhou Chemical Laboratory

198 Kezhu Road, Sciencetech Park Guangzhou Economic & Technology Development District, Guangzhou, China 510663 t (86-20) 82155555 f (86-20) 82075113 www.sgsgroup.com.cn
中国·广州·经济技术开发区科学城科珠路198号 邮编: 510663 t (86-20) 82155555 f (86-20) 82075113 e sgs.china@sgs.com

ATTACHMENTS

RoHS Testing Flow Chart

- 1) Name of the person who made testing: Bruce Xiao / Sunny Hu
- 2) Name of the person in charge of testing: Bella Wang / Cutey Yu
- 3) These samples were dissolved totally by pre-conditioning method according to below flow chart (Cr⁶⁺ and PBBs/PBDEs test method excluded).

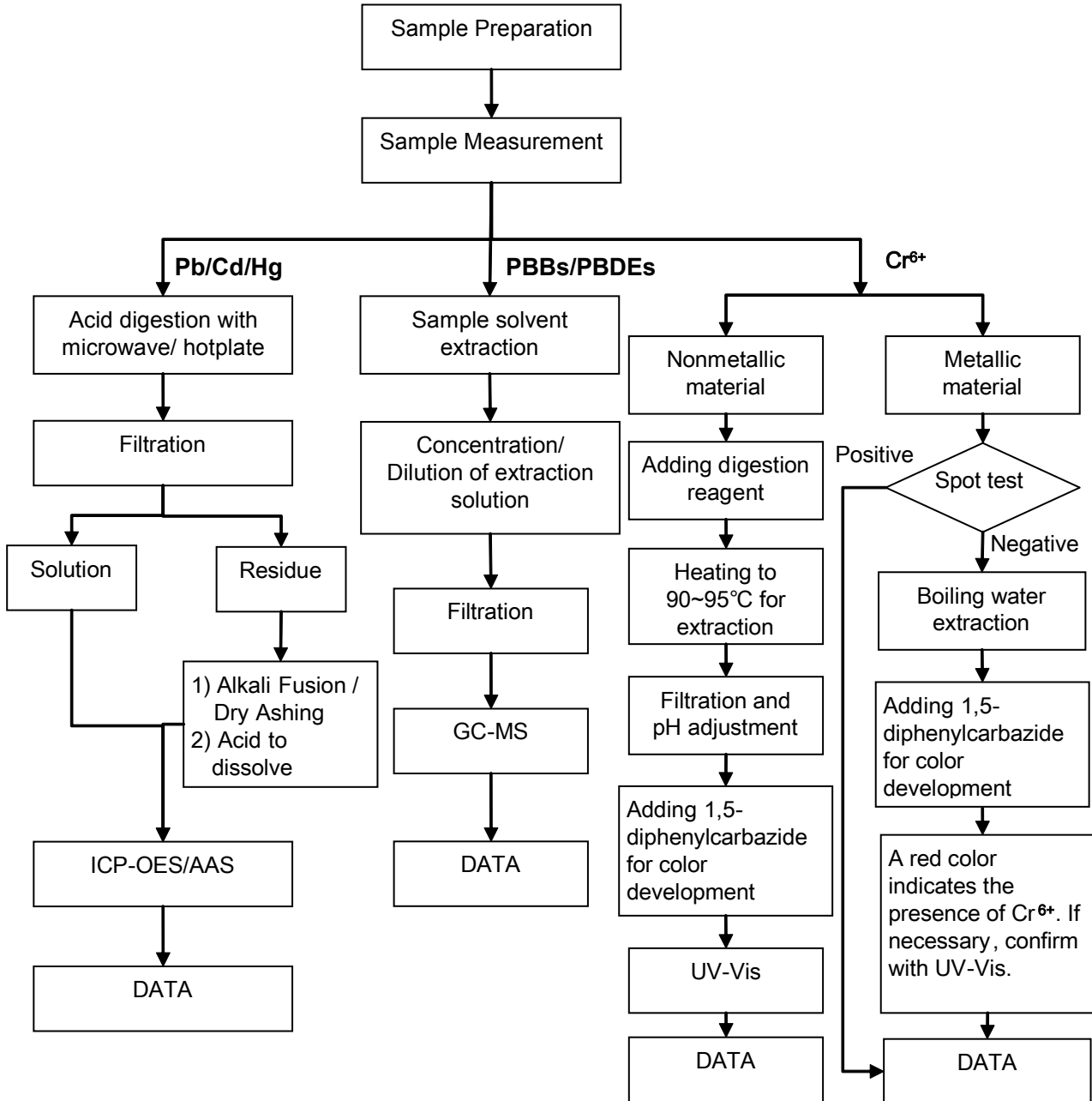

This document is issued by the Company subject to its General Conditions of Service printed overleaf, available on request or accessible at <http://www.sgs.com/en/Terms-and-Conditions.aspx> and, for electronic format documents, subject to Terms and Conditions for Electronic Documents at <http://www.sgs.com/en/Terms-and-Conditions/Terms-e-Documents.aspx>. Attention is drawn to the limitation of liability, indemnification and jurisdiction issues defined therein. Any holder of this document is advised that information contained hereon reflects the Company's findings at the time of its intervention only and within the limits of Client's instructions, if any. The Company's sole responsibility is to its Client and this document does not exonerate parties to a transaction from exercising all their rights and obligations under the transaction documents. This document cannot be reproduced except in full, without prior written approval of the Company. Any unauthorized alteration, forgery or falsification of the content or appearance of this document is unlawful and offenders may be prosecuted to the fullest extent of the law. Unless otherwise stated the results shown in this test report refer only to the sample(s) tested.

Attention: To check the authenticity of testing /inspection report & certificate, please contact us at telephone: (86-755) 8307 1443, or email: CN.Doccheck@sgs.com

198 Kezhu Road, Sciencetech Park Guangzhou Economic & Technology Development District, Guangzhou, China 510663 t (86-20) 82155555 f (86-20) 82075113 www.sgs.com.cn
 中国·广州·经济技术开发区科学城科珠路198号 邮编: 510663 t (86-20) 82155555 f (86-20) 82075113 e sgs.china@sgs.com

ATTACHMENTS

Phthalates Testing Flow Chart

- 1) Name of the person who made testing: Sunny Hu
- 2) Name of the person in charge of testing: Cutey Yu

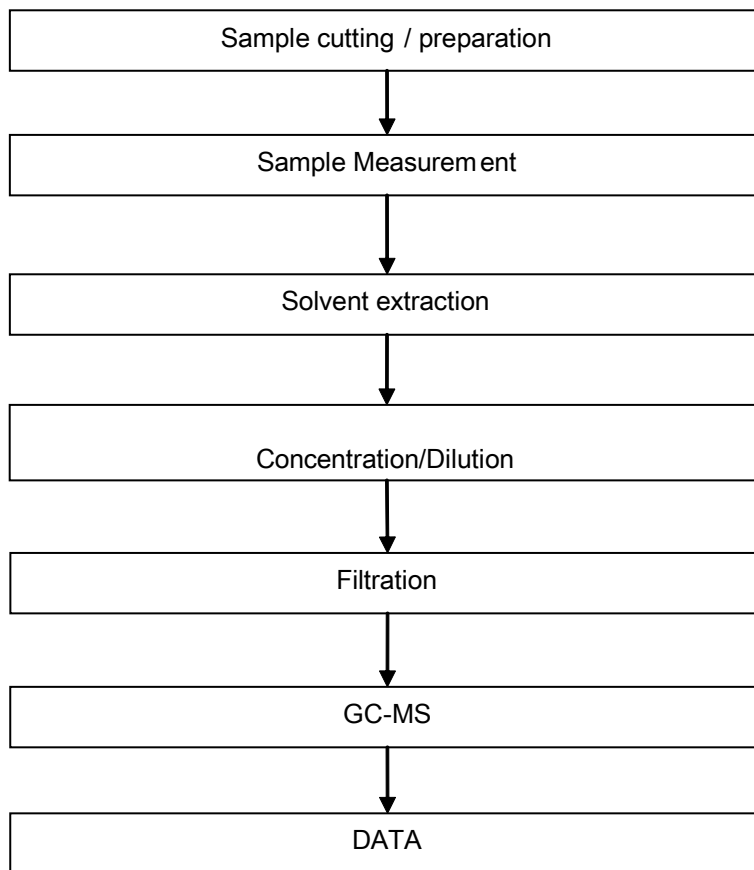

This document is issued by the Company subject to its General Conditions of Service printed overleaf, available on request or accessible at <http://www.sgs.com/en/Terms-and-Conditions.aspx> and, for electronic format documents, subject to Terms and Conditions for Electronic Documents at <http://www.sgs.com/en/Terms-and-Conditions/Terms-e-Documents.aspx>. Attention is drawn to the limitation of liability, indemnification and jurisdiction issues defined therein. Any holder of this document is advised that information contained hereon reflects the Company's findings at the time of its intervention only and within the limits of Client's instructions, if any. The Company's sole responsibility is to its Client and this document does not exonerate parties to a transaction from exercising all their rights and obligations under the transaction documents. This document cannot be reproduced except in full, without prior written approval of the Company. Any unauthorized alteration, forgery or falsification of the content or appearance of this document is unlawful and offenders may be prosecuted to the fullest extent of the law. Unless otherwise stated the results shown in this test report refer only to the sample(s) tested.

Attention: To check the authenticity of testing / inspection report & certificate, please contact us at telephone: (86-755) 8307 1443, or email: CN.Doccheck@sgs.com

ATTACHMENTS

Halogen Testing Flow Chart

- 1) Name of the person who made testing: Hanming Xiao
- 2) Name of the person in charge of testing: Bella Wang

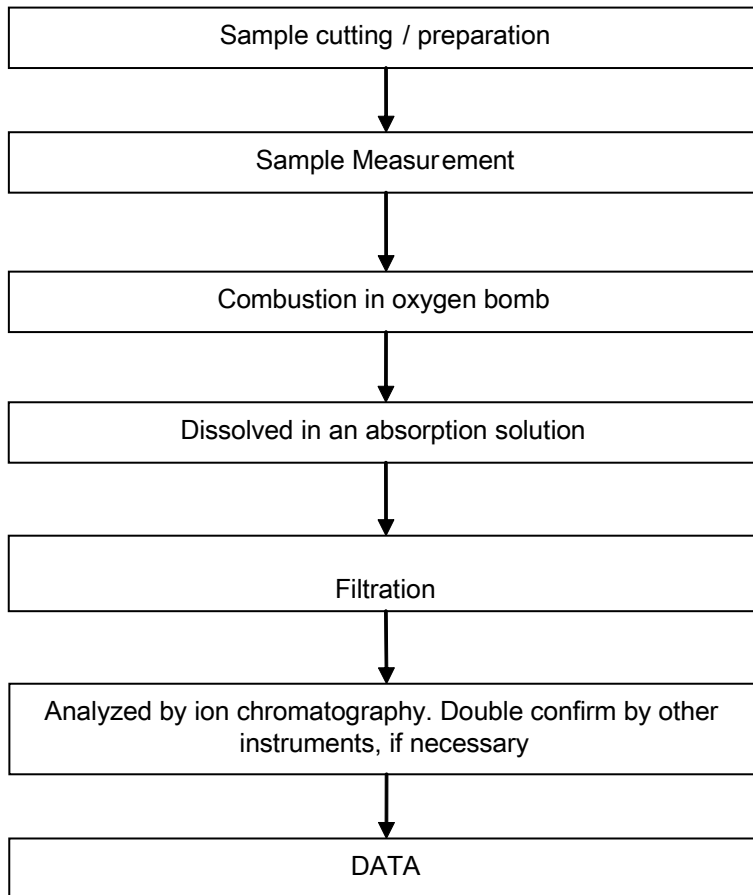

This document is issued by the Company subject to its General Conditions of Service printed overleaf, available on request or accessible at <http://www.sgs.com/en/Terms-and-Conditions.aspx> and, for electronic format documents, subject to Terms and Conditions for Electronic Documents at <http://www.sgs.com/en/Terms-and-Conditions/Terms-e-Documents.aspx>. Attention is drawn to the limitation of liability, indemnification and jurisdiction issues defined therein. Any holder of this document is advised that information contained hereon reflects the Company's findings at the time of its intervention only and within the limits of Client's instructions, if any. The Company's sole responsibility is to its Client and this document does not exonerate parties to a transaction from exercising all their rights and obligations under the transaction documents. This document cannot be reproduced except in full, without prior written approval of the Company. Any unauthorized alteration, forgery or falsification of the content or appearance of this document is unlawful and offenders may be prosecuted to the fullest extent of the law. Unless otherwise stated the results shown in this test report refer only to the sample(s) tested.

Attention: To check the authenticity of testing / inspection report & certificate, please contact us at telephone: (86-755) 8307 1443, or email: CN.Doccheck@sgs.com

198 Kezhu Road, Sciencetech Park Guangzhou Economic & Technology Development District, Guangzhou, China 510663 t (86-20) 82155555 f (86-20) 82075113 www.sgsgroup.com.cn
中国·广州·经济技术开发区科学城科珠路198号 邮编: 510663 t (86-20) 82155555 f (86-20) 82075113 e sgs.china@sgs.com

Sample photo:

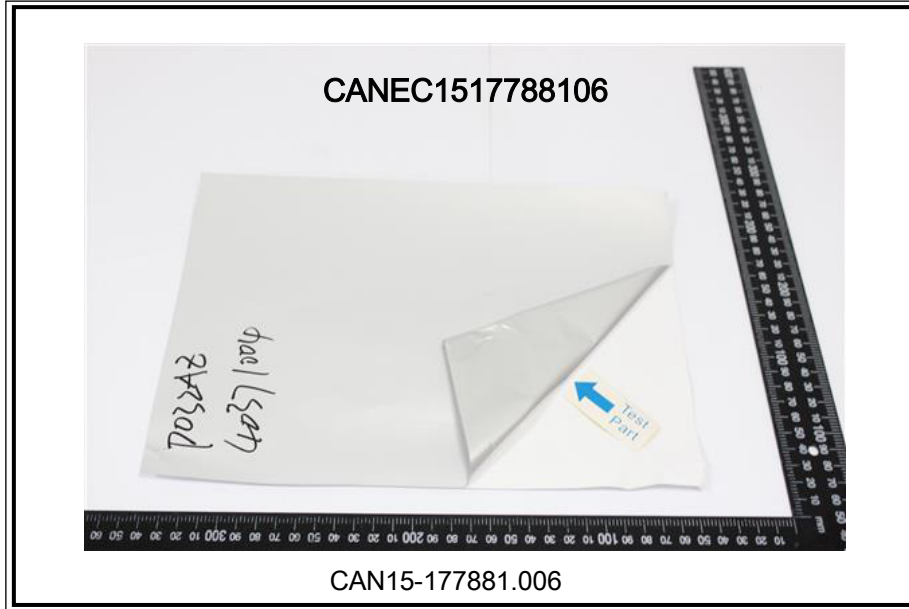

SGS authenticate the photo on original report only

*** End of Report ***



中国认可
检测
TESTING
CNAS L0599

Test Report

No. SHAEC1515770519

Date: 13 Aug 2015

Page 1 of 5

NANTONG DIC COLOR CO.,LTD

NO 11 ZHONGYANG ROAD NANTONG ECONOMIC&TECHNOLOGICAL DEVELOPMENT AREA JIANGSU PROVINCE

The following sample(s) was/were submitted and identified on behalf of the clients as : DRAGON-FC BLACK

SGS Job No. : SP15-026570 - SH

Date of Sample Received : 06 Aug 2015

Testing Period : 06 Aug 2015 - 13 Aug 2015

Test Requested : Selected test(s) as requested by client.

Test Method : Please refer to next page(s).

Test Results : Please refer to next page(s).

Conclusion : Based on the performed tests on submitted sample(s), the results of Lead, Mercury, Cadmium, Hexavalent chromium, Polybrominated biphenyls (PBBs), Polybrominated diphenyl ethers (PBDEs) comply with the limits as set by RoHS Directive 2011/65/EU Annex II; recasting 2002/95/EC.

Signed for and on behalf of
SGS-CSTC Standards Technical Services (Shanghai) Co., Ltd.

Terry Wang
Approved Signatory



This document is issued by the Company subject to its General Conditions of Service printed overleaf, available on request or accessible at <http://www.sgs.com/en/Terms-and-Conditions.aspx> and, for electronic format documents, subject to Terms and Conditions for Electronic Documents at <http://www.sgs.com/en/Terms-and-Conditions/Terms-e-Documents.aspx>. Attention is drawn to the limitation of liability, indemnification and jurisdiction issues defined therein. Any holder of this document is advised that information contained hereon reflects the Company's findings at the time of its intervention only and within the limits of Client's instructions, if any. The Company's sole responsibility is to its Client and this document does not exonerate parties to a transaction from exercising all their rights and obligations under the transaction documents. This document cannot be reproduced except in full, without prior written approval of the Company. Any unauthorized alteration, forgery or falsification of the content or appearance of this document is unlawful and offenders may be prosecuted to the fullest extent of the law. Unless otherwise stated the results shown in this test report refer only to the sample(s) tested.

Attention: To check the authenticity of testing /inspection report & certificate, please contact us at telephone: (86-755) 8307 1443, or email: CN.Doccheck@sgs.com

3rd Building, No.889 Yishan Road Xuhui District, Shanghai China 200233
中国·上海·徐汇区宜山路889号3号楼 邮编: 200233

tE&E (86-21) 61402553 fE&E (86-21) 64953679 www.sgs.com.cn
tHL (86-21) 61402594 fHL (86-21) 61156899 e sgs.china@sgs.com

Test Report

No. SHAEC1515770519

Date: 13 Aug 2015

Page 2 of 5

Test Results :

Test Part Description :

Specimen No.	SGS Sample ID	Description
SN1	SHA15-157705.015	Black mud

Remarks :

- (1) 1 mg/kg = 0.0001%
- (2) MDL = Method Detection Limit
- (3) ND = Not Detected (< MDL)
- (4) "-" = Not Regulated

RoHS Directive 2011/65/EU

- Test Method :
- (1) With reference to IEC 62321-5:2013, determination of Cadmium by ICP-OES.
 - (2) With reference to IEC 62321-5:2013, determination of Lead by ICP-OES.
 - (3) With reference to IEC 62321-4:2013, determination of Mercury by ICP-OES.
 - (4) With reference to IEC 62321:2008, determination of Hexavalent Chromium by Colorimetric Method using UV-Vis.
 - (5) With reference to IEC 62321:2008, determination of PBBs and PBDEs by GC-MS.

Test Item(s)	Limit	Unit	MDL	015
Cadmium (Cd)	100	mg/kg	2	ND
Lead (Pb)	1000	mg/kg	2	ND
Mercury (Hg)	1000	mg/kg	2	ND
Hexavalent Chromium (Cr(VI))	1000	mg/kg	2	ND
Sum of PBBs	1000	mg/kg	-	ND
Monobromobiphenyl	-	mg/kg	5	ND
Dibromobiphenyl	-	mg/kg	5	ND
Tribromobiphenyl	-	mg/kg	5	ND
Tetrabromobiphenyl	-	mg/kg	5	ND
Pentabromobiphenyl	-	mg/kg	5	ND
Hexabromobiphenyl	-	mg/kg	5	ND
Heptabromobiphenyl	-	mg/kg	5	ND
Octabromobiphenyl	-	mg/kg	5	ND
Nonabromobiphenyl	-	mg/kg	5	ND
Decabromobiphenyl	-	mg/kg	5	ND
Sum of PBDEs	1000	mg/kg	-	ND
Monobromodiphenyl ether	-	mg/kg	5	ND



This document is issued by the Company subject to its General Conditions of Service printed overleaf, available on request or accessible at <http://www.sgs.com/en/Terms-and-Conditions.aspx> and, for electronic format documents, subject to Terms and Conditions for Electronic Documents at <http://www.sgs.com/en/Terms-and-Conditions/Terms-e-Documents.aspx>. Attention is drawn to the limitation of liability, indemnification and jurisdiction issues defined therein. Any holder of this document is advised that information contained hereon reflects the Company's findings at the time of its intervention only and within the limits of Client's instructions, if any. The Company's sole responsibility is to its Client and this document does not exonerate parties to a transaction from exercising all their rights and obligations under the transaction documents. This document cannot be reproduced except in full, without prior written approval of the Company. Any unauthorized alteration, forgery or falsification of the content or appearance of this document is unlawful and offenders may be prosecuted to the fullest extent of the law. Unless otherwise stated the results shown in this test report refer only to the sample(s) tested.

Attention: To check the authenticity of testing /inspection report & certificate, please contact us at telephone: (86-755) 8307 1443, or email: CN.Doccheck@sgs.com

Test Report

No. SHAEC1515770519

Date: 13 Aug 2015

Page 3 of 5

<u>Test Item(s)</u>	<u>Limit</u>	<u>Unit</u>	<u>MDL</u>	<u>015</u>
Dibromodiphenyl ether	-	mg/kg	5	ND
Tribromodiphenyl ether	-	mg/kg	5	ND
Tetrabromodiphenyl ether	-	mg/kg	5	ND
Pentabromodiphenyl ether	-	mg/kg	5	ND
Hexabromodiphenyl ether	-	mg/kg	5	ND
Heptabromodiphenyl ether	-	mg/kg	5	ND
Octabromodiphenyl ether	-	mg/kg	5	ND
Nonabromodiphenyl ether	-	mg/kg	5	ND
Decabromodiphenyl ether	-	mg/kg	5	ND

Notes :

- (1) The maximum permissible limit is quoted from the directive 2011/65/EU, Annex II
- (2) Result shown is of the total weight of wet sample.



This document is issued by the Company subject to its General Conditions of Service printed overleaf, available on request or accessible at <http://www.sgs.com/en/Terms-and-Conditions.aspx> and, for electronic format documents, subject to Terms and Conditions for Electronic Documents at <http://www.sgs.com/en/Terms-and-Conditions/Terms-e-Documents.aspx>. Attention is drawn to the limitation of liability, indemnification and jurisdiction issues defined therein. Any holder of this document is advised that information contained hereon reflects the Company's findings at the time of its intervention only and within the limits of Client's instructions, if any. The Company's sole responsibility is to its Client and this document does not exonerate parties to a transaction from exercising all their rights and obligations under the transaction documents. This document cannot be reproduced except in full, without prior written approval of the Company. Any unauthorized alteration, forgery or falsification of the content or appearance of this document is unlawful and offenders may be prosecuted to the fullest extent of the law. Unless otherwise stated the results shown in this test report refer only to the sample(s) tested.

Attention: To check the authenticity of testing /inspection report & certificate, please contact us at telephone: (86-755) 8307 1443, or email: CN.Doccheck@sgs.com

ATTACHMENTS
RoHS Testing Flow Chart

- 1) Name of the person who made testing: Bob Zhang/Gary Xu/Zengzhen Zhu/Sunny Qin
- 2) Name of the person in charge of testing: Jan Shi/Summer Jin/Jessy Huang/Stone Chen
- 3) These samples were dissolved totally by pre-conditioning method according to below flow chart. (Cr⁶⁺ and PBBs/PBDEs test method excluded)

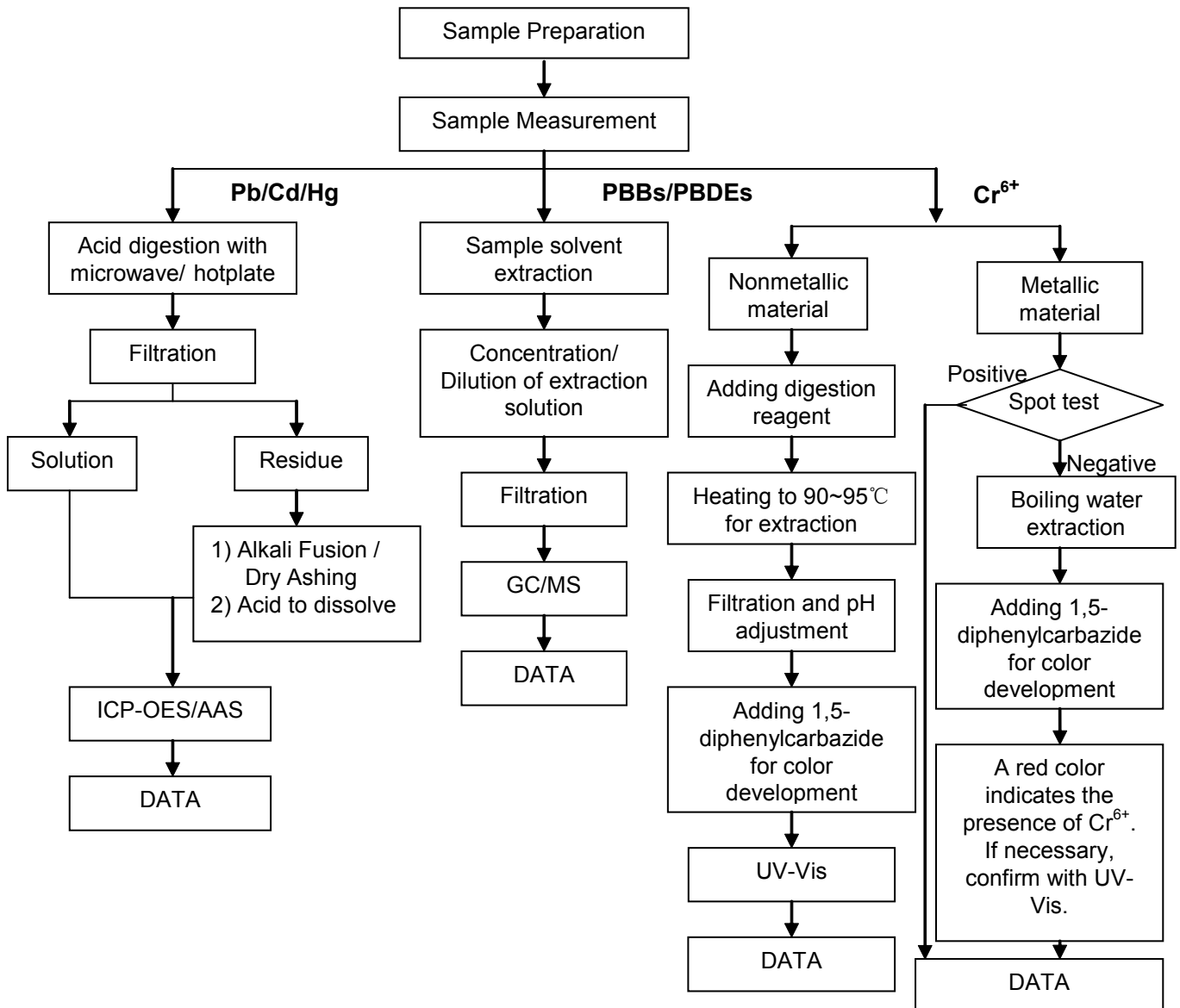

This document is issued by the Company subject to its General Conditions of Service printed overleaf, available on request or accessible at <http://www.sgs.com/en/Terms-and-Conditions.aspx> and, for electronic format documents, subject to Terms and Conditions for Electronic Documents at <http://www.sgs.com/en/Terms-and-Conditions/Terms-e-Document.aspx>. Attention is drawn to the limitation of liability, indemnification and jurisdiction issues defined therein. Any holder of this document is advised that information contained hereon reflects the Company's findings at the time of its intervention only and within the limits of Client's instructions, if any. The Company's sole responsibility is to its Client and this document does not exonerate parties to a transaction from exercising all their rights and obligations under the transaction documents. This document cannot be reproduced except in full, without prior written approval of the Company. Any unauthorized alteration, forgery or falsification of the content or appearance of this document is unlawful and offenders may be prosecuted to the fullest extent of the law. Unless otherwise stated the results shown in this test report refer only to the sample(s) tested.

Attention: To check the authenticity of testing /inspection report & certificate, please contact us at telephone: (86-755) 8307 1443, or email: CN.Doccheck@sgs.com

Test Report

No. SHAEC1515770519

Date: 13 Aug 2015

Page 5 of 5

Sample photo:



SGS authenticate the photo on original report only

*** End of Report ***



This document is issued by the Company subject to its General Conditions of Service printed overleaf, available on request or accessible at <http://www.sgs.com/en/Terms-and-Conditions.aspx> and, for electronic format documents, subject to Terms and Conditions for Electronic Documents at <http://www.sgs.com/en/Terms-and-Conditions/Terms-e-Documents.aspx>. Attention is drawn to the limitation of liability, indemnification and jurisdiction issues defined therein. Any holder of this document is advised that information contained hereon reflects the Company's findings at the time of its intervention only and within the limits of Client's instructions, if any. The Company's sole responsibility is to its Client and this document does not exonerate parties to a transaction from exercising all their rights and obligations under the transaction documents. This document cannot be reproduced except in full, without prior written approval of the Company. Any unauthorized alteration, forgery or falsification of the content or appearance of this document is unlawful and offenders may be prosecuted to the fullest extent of the law. Unless otherwise stated the results shown in this test report refer only to the sample(s) tested.

Attention: To check the authenticity of testing /inspection report & certificate, please contact us at telephone: (86-755) 8307 1443, or email: CN.Doccheck@sgs.com

Test Report

Report No. SCL01H013155001

Page 1 of 7

Applicant DONGGUAN SUNWAY PRINTING INDUSTRY CO.,LTD

Address YINLING INDUSTRIAL, XIAQIAO GUANLONG ROAD, DONGCHENG ZONE,
DONGGUAN CITY, GUANGDONG PROVINCE, CHINA

The following sample(s) and sample information was/were submitted and identified by/on the behalf of the client

Sample Name 上光PP膜
Part No. OPAT
Color 透明
Manufacturer FUZHOU
Sample Received Date Mar. 2, 2015
Testing Period Mar. 2, 2015 to Mar. 4, 2015

Test Requested As specified by client, to test Lead (Pb), Cadmium (Cd), Mercury (Hg), Hexavalent Chromium(Cr(VI)), Polybrominated Biphenyl(PBBs), Polybrominated Diphenyl Ethers(PBDEs), Fluorine(F), Chlorine(Cl), Bromine(Br), Iodine(I), Hexabromocyclododecane (HBCDD), Phthalates in the submitted sample(s).

Test Method Please refer to the following page(s).

Test Result(s) Please refer to the following page(s).

Tested by

Mett

Reviewed by

Cathy

Approved by

Danny Liu

Date

Mar. 4, 2015

Danny Liu
Technical Manager

No. R148192600

Centre Testing International (Shenzhen) Co., Ltd. Hongwei Industrial Zone, Bao'an 70 District, Shenzhen, Guangdong, China

Test Report

Report No. SCL01H013155001

Page 2 of 7

Test Method

Test Item(s)	Test Method	Measured Equipment(s)
Lead (Pb)	IEC 62321-5:2013 Ed.1.0	ICP-OES
Cadmium (Cd)	IEC 62321-5:2013 Ed.1.0	ICP-OES
Mercury (Hg)	IEC 62321-4:2013 Ed.1.0	ICP-OES
Hexavalent Chromium(Cr(VI))	IEC 62321:2008 Ed.1 Annex C	UV-Vis
Polybrominated Biphenyl(PBBs)	IEC 62321:2008 Ed.1 Annex A	GC-MS
Polybrominated Diphenyl Ethers(PBDEs)	IEC 62321:2008 Ed.1 Annex A	GC-MS
Fluorine(F)	Refer to BS EN 14582:2007	IC
Chlorine(Cl)	Refer to BS EN 14582:2007	IC
Bromine(Br)	Refer to BS EN 14582:2007	IC
Iodine(I)	Refer to BS EN 14582:2007	IC
Hexabromocyclododecane (HBCDD)	Refer to US EPA 3540C:1996 & US EPA 8270D:2007	GC-MS
Phthalates	Refer to EN 14372:2004(E)	GC-MS

Test Result(s)

Tested Item(s)	Result	MDL
Lead (Pb)	N.D.	2 mg/kg
Cadmium (Cd)	N.D.	2 mg/kg
Mercury (Hg)	N.D.	2 mg/kg
Hexavalent Chromium (Cr(VI))	N.D.	2 mg/kg

Tested Item(s)	Result	MDL
Polybrominated Biphenyl(PBBs)		
Monobromobiphenyl	N.D.	5 mg/kg
Dibromobiphenyl	N.D.	5 mg/kg
Tribromobiphenyl	N.D.	5 mg/kg
Tetrabromobiphenyl	N.D.	5 mg/kg
Pentabromobiphenyl	N.D.	5 mg/kg
Hexabromobiphenyl	N.D.	5 mg/kg
Heptabromobiphenyl	N.D.	5 mg/kg
Octabromobiphenyl	N.D.	5 mg/kg
Nonabromobiphenyl	N.D.	5 mg/kg
Decabromobiphenyl	N.D.	5 mg/kg

Test Report

Report No. SCL01H013155001

Page 3 of 7

Tested Item(s)	Result	MDL
Polybrominated Diphenyl Ethers(PBDEs)		
Monobromodiphenyl ether	N.D.	5 mg/kg
Dibromodiphenyl ether	N.D.	5 mg/kg
Tribromodiphenyl ether	N.D.	5 mg/kg
Tetrabromodiphenyl ether	N.D.	5 mg/kg
Pentabromodiphenyl ether	N.D.	5 mg/kg
Hexabromodiphenyl ether	N.D.	5 mg/kg
Heptabromodiphenyl ether	N.D.	5 mg/kg
Octabromodiphenyl ether	N.D.	5 mg/kg
Nonabromodiphenyl ether	N.D.	5 mg/kg
Decabromodiphenyl ether	N.D.	5 mg/kg

Tested Item(s)	Result	MDL
Halogen(s)		
Fluorine(F)	N.D.	10 mg/kg
Chlorine(Cl)	N.D.	10 mg/kg
Bromine(Br)	N.D.	10 mg/kg
Iodine(I)	N.D.	10 mg/kg

Tested Item(s)	Result	MDL
Hexabromocyclododecane (HBCDD)	N.D.	5 mg/kg

Test Report

Report No. SCL01H013155001

Page 4 of 7

Tested Item(s)	Result	MDL
Phthalates		
Dimethyl phthalate(DMP) CAS#:131-11-3	N.D.	50 mg/kg
Diethyl phthalate(DEP) CAS#:84-66-2	N.D.	50 mg/kg
Diisobutyl phthalate(DIBP) CAS#:84-69-5	N.D.	50 mg/kg
Dibutyl phthalate(DBP) CAS#:84-74-2	N.D.	50 mg/kg
Butylbenzyl phthalate(BBP) CAS#:85-68-7	N.D.	50 mg/kg
Di-2-ethylhexyl phthalate(DEHP) CAS#:117-81-7	N.D.	50 mg/kg
Di-n-octyl phthalate(DNOP) CAS#:117-84-0	N.D.	50 mg/kg
Diisononyl phthalate(DINP) CAS#:28553-12-0,68515-48-0	N.D.	50 mg/kg
Diisodecyl phthalate(DIDP) CAS#:26761-40-0,68515-49-1	N.D.	50 mg/kg
Di-n-hexyl phthalate (DNHP) CAS#:84-75-3	N.D.	50 mg/kg

Tested Sample/Part Description Transparent plastic film with adhesive paste

Remark: **The sample(s) had been dissolved totally tested for Lead, Cadmium, Mercury.**

- MDL = Method Detection Limit
- N.D. = Not Detected (<=MDL)
- mg/kg = ppm = parts per million

Test Report

Report No. SCL01H013155001

Page 5 of 7

Test Process

1. Lead (Pb), Cadmium (Cd)

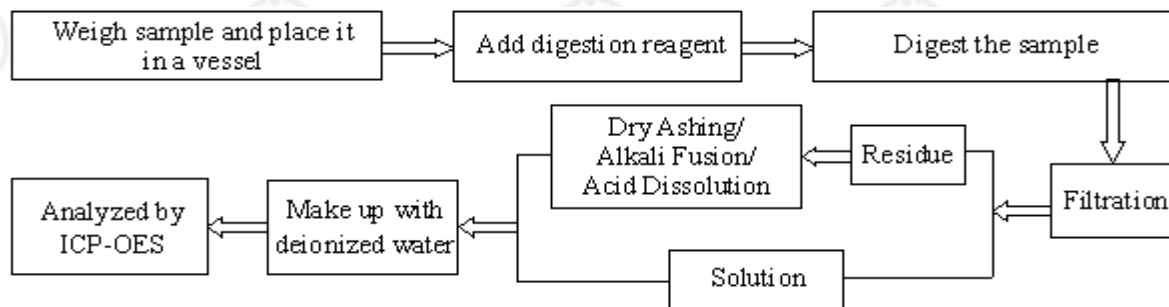

2. Mercury (Hg)

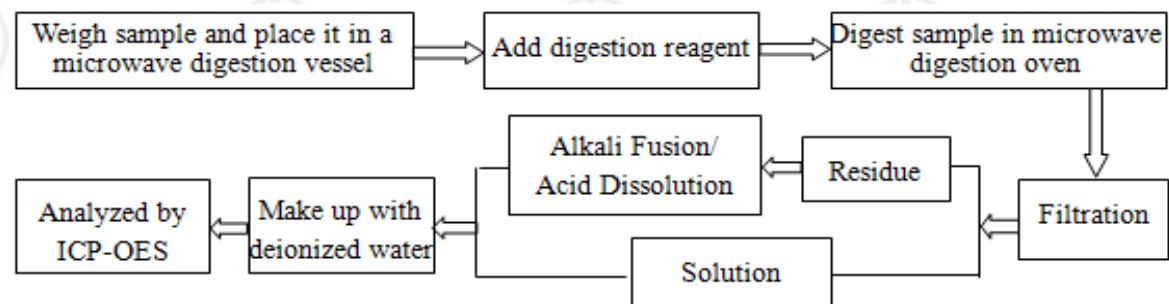

3. Hexavalent Chromium(Cr(VI))

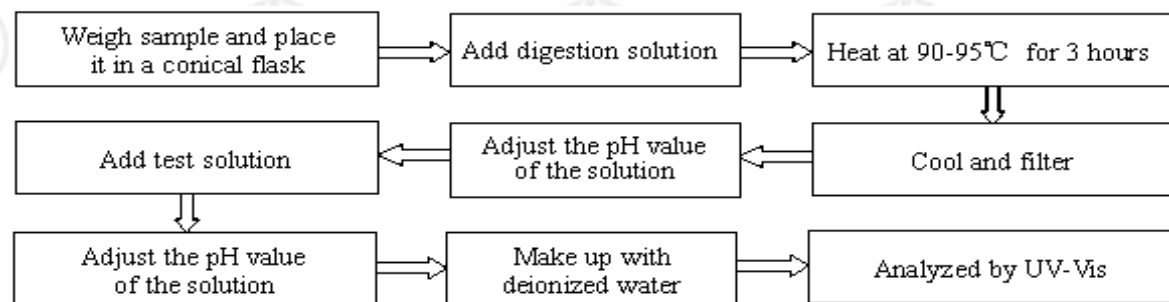

4. Phthalates

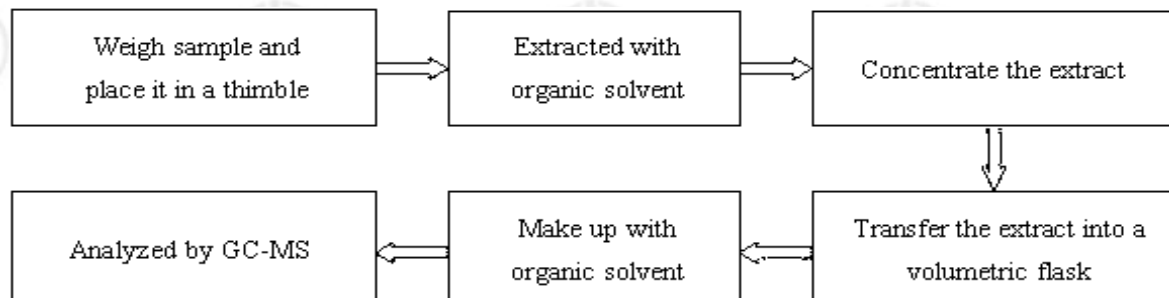

Test Report

Report No. SCL01H013155001

Page 6 of 7

5. Bromine(Br), Chlorine(Cl), Fluorine(F), Iodine(I)

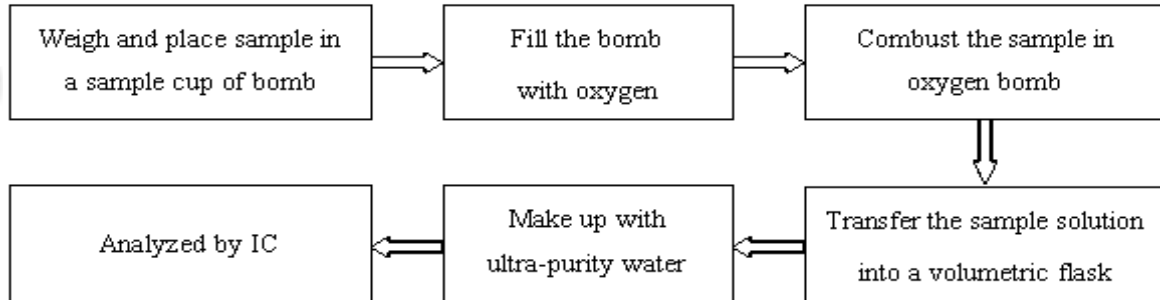

6. Polybrominated Biphenyl(PBBs) , Polybrominated Diphenyl Ethers(PBDEs)

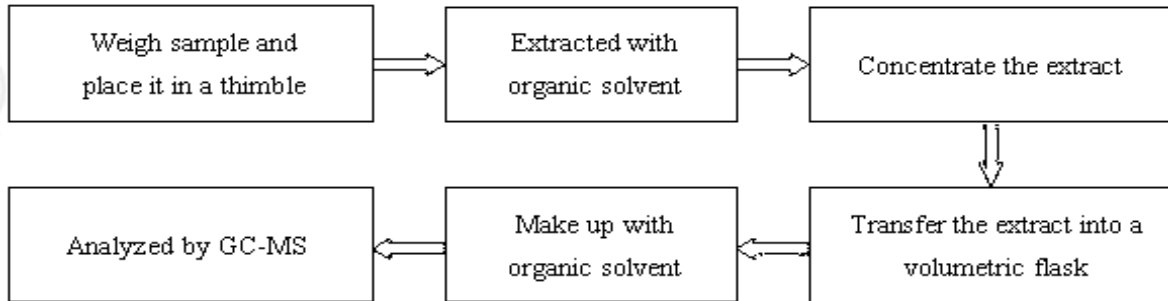

7. Hexabromocyclododecane (HBCDD)

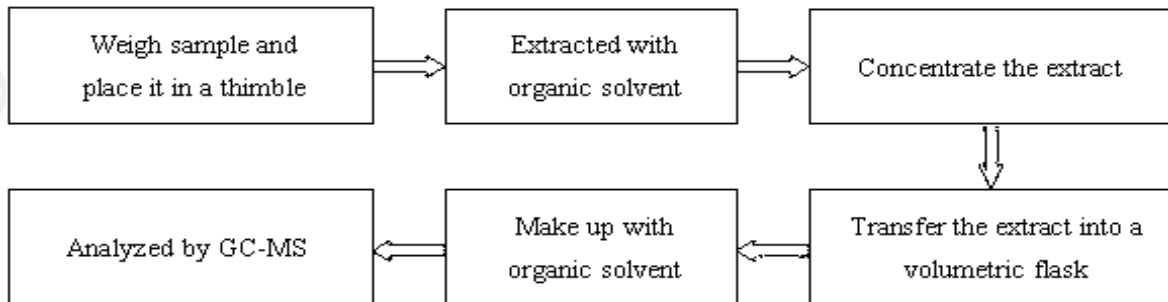

Test Report

Report No. SCL01H013155001

Page 7 of 7

Photo(s) of the sample(s)

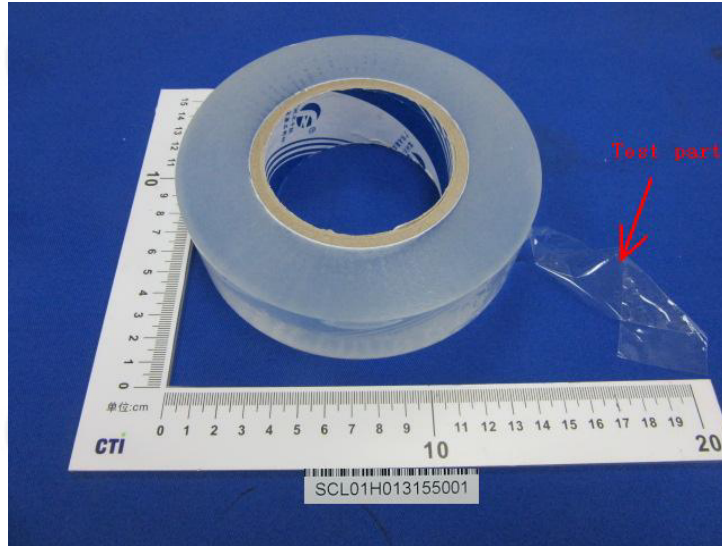

*** End of report ***

The test report is effective only with both signature and specialized stamp. The result(s) shown in this report refer only to the sample(s) tested. Without written approval of CTI, this report can't be reproduced except in full.

測試報告

Test Report

號碼(No.) : CE/2015/53008

日期(Date) : 2015/05/20

頁數(Page): 1 of 11

喬越實業有限公司

SIL-MORE INDUSTRIAL LTD.

新北市三重區興德路100號16樓

16F, NO. 100, XINGDE RD., SANCHONG DISTRICT, NEW TAIPEI CITY 24158, TAIWAN



以下測試樣品係由申請廠商所提供及確認 (The following sample(s) was/were submitted and identified by/on behalf of the applicant as) :

樣品名稱(Sample Description) : DOW CORNING TC-5630 THERMALLY CONDUCTIVE COMPOUND

收件日期(Sample Receiving Date) : 2015/05/14

測試期間(Testing Period) : 2015/05/14 TO 2015/05/20

=====

測試需求(Test Requested) :

- (1) 依據客戶要求, 參考RoHS 2011/65/EU Annex II 指令測試鎘、鉛、汞、六價鉻、多溴聯苯、多溴聯苯醚. (As specified by client, with reference to RoHS Directive 2011/65/EU Annex II to determine Cadmium, Lead, Mercury, Cr(VI), PBBs, PBDEs contents in the submitted sample.)
- (2) 依據客戶要求, 參考 WTO/TBT 通報 G/TBT/N/EU/256, 檢測 DBP, BBP, DEHP, DIBP. (As specified by client, with reference to G/TBT/N/EU/256 of WTO/TBT to test DBP, BBP, DEHP, DIBP.)
- (3) 其他測試項目請見下一頁 . / Please refer to next pages for the other item(s).

測試結果(Test Results) : 請見下一頁 (Please refer to next pages).

Troy Chang / Manager - Tech
Signed for and on behalf of
SGS TAIWAN LTD.
Chemical Laboratory - Taipei

This document is issued by the Company subject to its General Conditions of Service printed overleaf, available on request or accessible at <http://www.sgs.com/en/Terms-and-Conditions.aspx> and, for electronic format documents, subject to Terms and Conditions for Electronic Documents at <http://www.sgs.com/en/Terms-and-Conditions/Termse-Document.aspx>. Attention is drawn to the limitation of liability, indemnification and jurisdiction issues defined therein. Any holder of this document is advised that information contained hereon reflects the Company's findings at the time of its intervention only and within the limits of client's instruction, if any. The Company's sole responsibility is to its Client and this document does not exonerate parties to a transaction from exercising all their rights and obligations under the transaction documents. This document cannot be reproduced, except in full, without prior written approval of the Company. Any unauthorized alteration, forgery or falsification of the content or appearance of this document is unlawful and offenders may be prosecuted to the fullest extent of the law. Unless otherwise stated the results shown in this test report refer only to the sample(s) tested.

測試報告 Test Report

號碼(No.) : CE/2015/53008

日期(Date) : 2015/05/20

頁數(Page): 2 of 11

喬越實業有限公司

SIL-MORE INDUSTRIAL LTD.

新北市三重區興德路100號16樓

16F, NO. 100, XINGDE RD., SANCHONG DISTRICT, NEW TAIPEI CITY 24158, TAIWAN



測試結果(Test Results)

測試部位(PART NAME)No.1 : 灰色膏狀 (GRAY PASTE)

測試項目 (Test Items)	單位 (Unit)	測試方法 (Method)	方法偵測 極限值 (MDL)	結果 (Result)
				No.1
鎘 / Cadmium (Cd)	mg/kg	參考IEC 62321-5: 2013方法, 以感應 耦合電漿原子發射光譜儀檢測。 / With reference to IEC 62321-5: 2013 and performed by ICP-AES.	2	n.d.
鉛 / Lead (Pb)	mg/kg	參考IEC 62321-5: 2013方法, 以感應 耦合電漿原子發射光譜儀檢測。 / With reference to IEC 62321-5: 2013 and performed by ICP-AES.	2	n.d.
汞 / Mercury (Hg)	mg/kg	參考IEC 62321-4: 2013方法, 以感應 耦合電漿原子發射光譜儀檢測。 / With reference to IEC 62321-4: 2013 and performed by ICP-AES.	2	n.d.
六價鉻 / Hexavalent Chromium Cr(VI)	mg/kg	參考IEC 62321: 2008方法, 以UV-VIS 檢測。 / With reference to IEC 62321: 2008 and performed by UV- VIS.	2	n.d.
鄰苯二甲酸二異丁酯 / DIBP (Di- isobutyl phthalate) (CAS No.: 84-69- 5)	mg/kg	參考IEC 62321-8 (111/321/CD), 以氣 相層析儀/質譜儀檢測之。 / With reference to IEC 62321-8 (111/321/CD). Analysis was performed by GC/MS.	50	n.d.
鄰苯二甲酸二丁酯 / DBP (Dibutyl phthalate) (CAS No.: 84-74-2)	mg/kg	參考IEC 62321-8 (111/321/CD), 以氣 相層析儀/質譜儀檢測之。 / With reference to IEC 62321-8 (111/321/CD). Analysis was performed by GC/MS.	50	n.d.

This document is issued by the Company subject to its General Conditions of Service printed overleaf, available on request or accessible at <http://www.sgs.com/en/Terms-and-Conditions.aspx> and, for electronic format documents, subject to Terms and Conditions for Electronic Documents at <http://www.sgs.com/en/Terms-and-Conditions/Termse-Documents.aspx>. Attention is drawn to the limitation of liability, indemnification and jurisdiction issues defined therein. Any holder of this document is advised that information contained hereon reflects the Company's findings at the time of its intervention only and within the limits of client's instruction, if any. The Company's sole responsibility is to its Client and this document does not exonerate parties to a transaction from exercising all their rights and obligations under the transaction documents. This document cannot be reproduced, except in full, without prior written approval of the Company. Any unauthorized alteration, forgery or falsification of the content or appearance of this document is unlawful and offenders may be prosecuted to the fullest extent of the law. Unless otherwise stated the results shown in this test report refer only to the sample(s) tested.

測試報告

Test Report

號碼(No.) : CE/2015/53008

日期(Date) : 2015/05/20

頁數(Page): 3 of 11

喬越實業有限公司

SIL-MORE INDUSTRIAL LTD.

新北市三重區興德路100號16樓

16F, NO. 100, XINGDE RD., SANCHONG DISTRICT, NEW TAIPEI CITY 24158, TAIWAN



測試項目 (Test Items)	單位 (Unit)	測試方法 (Method)	方法偵測 極限值 (MDL)	結果 (Result)
				No.1
鄰苯二甲酸丁苯甲酯 / BBP (Butyl Benzyl phthalate) (CAS No.: 85-68-7)	mg/kg	參考IEC 62321-8 (111/321/CD), 以氣相層析儀/質譜儀檢測之。 / With reference to IEC 62321-8 (111/321/CD). Analysis was performed by GC/MS.	50	n.d.
鄰苯二甲酸二(2-乙基己基)酯 / DEHP (Di- (2-ethylhexyl) phthalate) (CAS No.: 117-81-7)	mg/kg	參考IEC 62321-8 (111/321/CD), 以氣相層析儀/質譜儀檢測之。 / With reference to IEC 62321-8 (111/321/CD). Analysis was performed by GC/MS.	50	n.d.
鄰苯二甲酸二正辛酯 / DNOP (Di-n-octyl phthalate) (CAS No.: 117-84-0)	mg/kg	參考IEC 62321-8 (111/321/CD), 以氣相層析儀/質譜儀檢測之。 / With reference to IEC 62321-8 (111/321/CD). Analysis was performed by GC/MS.	50	n.d.
鄰苯二甲酸二異壬酯 / DINP (Di-isononyl phthalate) (CAS No.: 28553-12-0; 68515-48-0)	mg/kg	參考IEC 62321-8 (111/321/CD), 以氣相層析儀/質譜儀檢測之。 / With reference to IEC 62321-8 (111/321/CD). Analysis was performed by GC/MS.	50	n.d.
鄰苯二甲酸二異癸酯 / DIDP (Di-isodecyl phthalate) (CAS No.: 26761-40-0; 68515-49-1)	mg/kg	參考IEC 62321-8 (111/321/CD), 以氣相層析儀/質譜儀檢測之。 / With reference to IEC 62321-8 (111/321/CD). Analysis was performed by GC/MS.	50	n.d.
鄰苯二甲酸二戊酯 / Di-n-pentyl phthalate (CAS No.: 131-18-0)	mg/kg	參考IEC 62321-8 (111/321/CD), 以氣相層析儀/質譜儀檢測之。 / With reference to IEC 62321-8 (111/321/CD). Analysis was performed by GC/MS.	50	n.d.

This document is issued by the Company subject to its General Conditions of Service printed overleaf, available on request or accessible at <http://www.sgs.com/en/Terms-and-Conditions.aspx> and, for electronic format documents, subject to Terms and Conditions for Electronic Documents at <http://www.sgs.com/en/Terms-and-Conditions/Termse-Documents.aspx>. Attention is drawn to the limitation of liability, indemnification and jurisdiction issues defined therein. Any holder of this document is advised that information contained hereon reflects the Company's findings at the time of its intervention only and within the limits of client's instruction, if any. The Company's sole responsibility is to its Client and this document does not exonerate parties to a transaction from exercising all their rights and obligations under the transaction documents. This document cannot be reproduced, except in full, without prior written approval of the Company. Any unauthorized alteration, forgery or falsification of the content or appearance of this document is unlawful and offenders may be prosecuted to the fullest extent of the law. Unless otherwise stated the results shown in this test report refer only to the sample(s) tested.

測試報告 Test Report

號碼(No.): CE/2015/53008

日期(Date): 2015/05/20

頁數(Page): 4 of 11

喬越實業有限公司

SIL-MORE INDUSTRIAL LTD.

新北市三重區興德路100號16樓

16F, NO. 100, XINGDE RD., SANCHONG DISTRICT, NEW TAIPEI CITY 24158, TAIWAN



測試項目 (Test Items)	單位 (Unit)	測試方法 (Method)	方法偵測 極限值 (MDL)	結果 (Result)
				No.1
六溴環十二烷及所有主要被辨別出的異構物 / Hexabromocyclododecane (HBCDD) and all major diastereoisomers identified (α - HBCDD, β - HBCDD, γ - HBCDD) (CAS No.: 25637-99-4 and 3194-55-6 (134237-51-7, 134237-50-6, 134237-52-8))	mg/kg	參考IEC 62321: 2008方法, 以氣相層析/質譜儀檢測. / With reference to IEC 62321: 2008 method. Analysis was performed by GC/MS.	5	n.d.
多溴聯苯總和 / Sum of PBBs	mg/kg	參考IEC 62321: 2008方法, 以氣相層析/質譜儀檢測. / With reference to IEC 62321: 2008 and performed by GC/MS.	-	n.d.
一溴聯苯 / Monobromobiphenyl	mg/kg		5	n.d.
二溴聯苯 / Dibromobiphenyl	mg/kg		5	n.d.
三溴聯苯 / Tribromobiphenyl	mg/kg		5	n.d.
四溴聯苯 / Tetrabromobiphenyl	mg/kg		5	n.d.
五溴聯苯 / Pentabromobiphenyl	mg/kg		5	n.d.
六溴聯苯 / Hexabromobiphenyl	mg/kg		5	n.d.
七溴聯苯 / Heptabromobiphenyl	mg/kg		5	n.d.
八溴聯苯 / Octabromobiphenyl	mg/kg		5	n.d.
九溴聯苯 / Nonabromobiphenyl	mg/kg		5	n.d.
十溴聯苯 / Decabromobiphenyl	mg/kg		5	n.d.
多溴聯苯醚總和 / Sum of PBDEs	mg/kg		-	n.d.
一溴聯苯醚 / Monobromodiphenyl ether	mg/kg		5	n.d.
二溴聯苯醚 / Dibromodiphenyl ether	mg/kg		5	n.d.
三溴聯苯醚 / Tribromodiphenyl ether	mg/kg		5	n.d.
四溴聯苯醚 / Tetrabromodiphenyl ether	mg/kg		5	n.d.
五溴聯苯醚 / Pentabromodiphenyl ether	mg/kg		5	n.d.
六溴聯苯醚 / Hexabromodiphenyl ether	mg/kg		5	n.d.
七溴聯苯醚 / Heptabromodiphenyl ether	mg/kg		5	n.d.
八溴聯苯醚 / Octabromodiphenyl ether	mg/kg		5	n.d.
九溴聯苯醚 / Nonabromodiphenyl ether	mg/kg	5	n.d.	
十溴聯苯醚 / Decabromodiphenyl ether	mg/kg	5	n.d.	

This document is issued by the Company subject to its General Conditions of Service printed overleaf, available on request or accessible at <http://www.sgs.com/en/Terms-and-Conditions.aspx> and, for electronic format documents, subject to Terms and Conditions for Electronic Documents at <http://www.sgs.com/en/Terms-and-Conditions/Termse-Document.aspx>. Attention is drawn to the limitation of liability, indemnification and jurisdiction issues defined therein. Any holder of this document is advised that information contained hereon reflects the Company's findings at the time of its intervention only and within the limits of client's instruction, if any. The Company's sole responsibility is to its Client and this document does not exonerate parties to a transaction from exercising all their rights and obligations under the transaction documents. This document cannot be reproduced, except in full, without prior written approval of the Company. Any unauthorized alteration, forgery or falsification of the content or appearance of this document is unlawful and offenders may be prosecuted to the fullest extent of the law. Unless otherwise stated the results shown in this test report refer only to the sample(s) tested.

測試報告 Test Report

號碼(No.) : CE/2015/53008

日期(Date) : 2015/05/20

頁數(Page): 5 of 11

喬越實業有限公司



SIL-MORE INDUSTRIAL LTD.

新北市三重區興德路100號16樓

16F, NO. 100, XINGDE RD., SANCHONG DISTRICT, NEW TAIPEI CITY 24158, TAIWAN

測試項目 (Test Items)	單位 (Unit)	測試方法 (Method)	方法偵測 極限值 (MDL)	結果 (Result)
				No.1
鹵素 / Halogen				
鹵素 (氟) / Halogen-Fluorine (F) (CAS No.: 14762-94-8)	mg/kg	參考BS EN 14582:2007, 以離子層析儀 分析. / With reference to BS EN 14582:2007. Analysis was performed by IC.	50	n.d.
鹵素 (氯) / Halogen-Chlorine (Cl) (CAS No.: 22537-15-1)	mg/kg		50	n.d.
鹵素 (溴) / Halogen-Bromine (Br) (CAS No.: 10097-32-2)	mg/kg		50	n.d.
鹵素 (碘) / Halogen-Iodine (I) (CAS No.: 14362-44-8)	mg/kg		50	n.d.

備註(Note) :

1. mg/kg = ppm ; 0.1wt% = 1000ppm
2. n.d. = Not Detected (未檢出)
3. MDL = Method Detection Limit (方法偵測極限值)
4. "-" = Not Regulated (無規格值)

測試報告 Test Report

號碼(No.) : CE/2015/53008

日期(Date) : 2015/05/20

頁數(Page): 6 of 11

喬越實業有限公司

SIL-MORE INDUSTRIAL LTD.

新北市三重區興德路100號16樓

16F, NO. 100, XINGDE RD., SANCHONG DISTRICT, NEW TAIPEI CITY 24158, TAIWAN



- 1) 根據以下的流程圖之條件，樣品已完全溶解。(六價鉻測試方法除外) / These samples were dissolved totally by pre-conditioning method according to below flow chart. (Cr⁶⁺ test method excluded)
- 2) 測試人員：楊登偉 / Name of the person who made measurement: Climbgreat Yang
- 3) 測試負責人：張啓興 / Name of the person in charge of measurement: Troy Chang

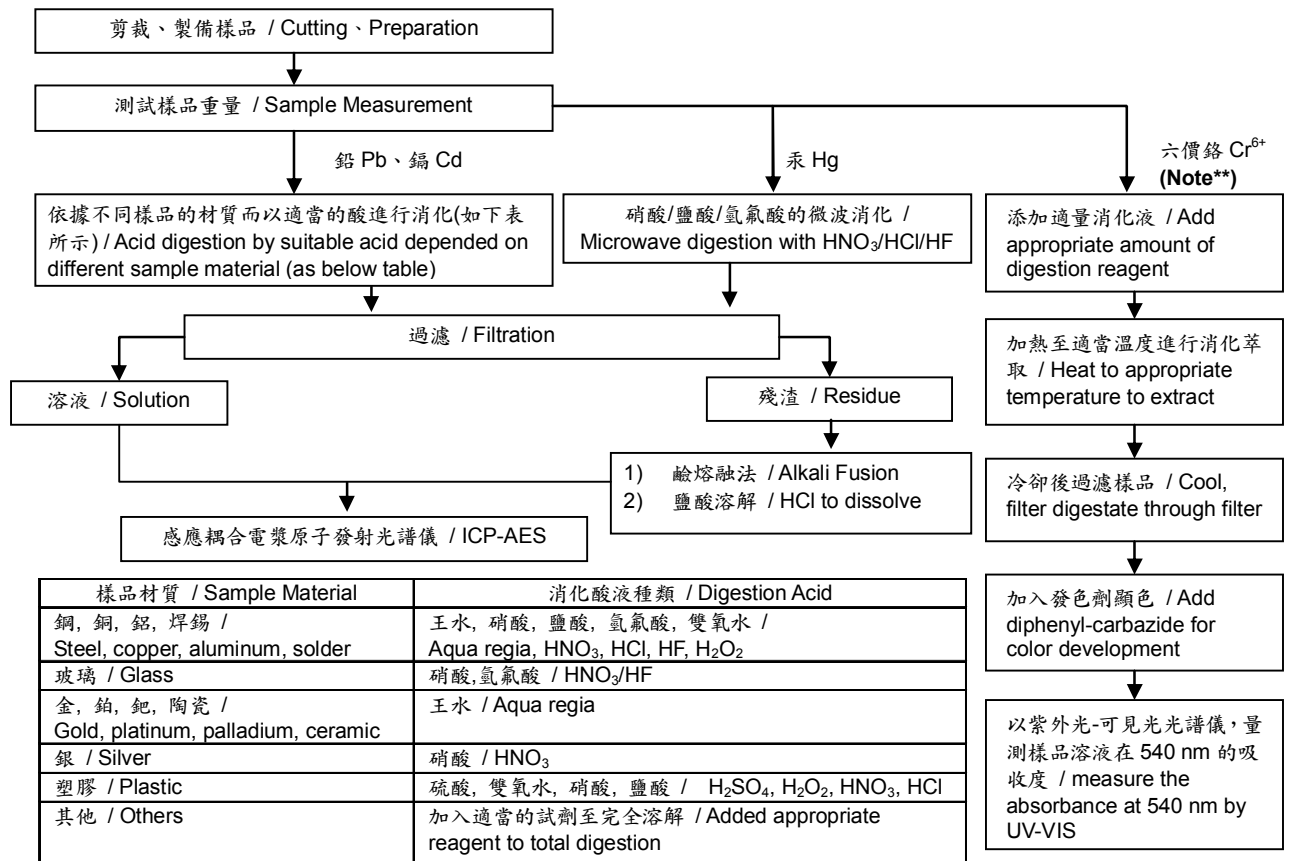

Note (For IEC 62321)**

- (1) 針對非金屬材料加入鹼性消化液，加熱至 90~95°C 萃取。 / For non-metallic material, add alkaline digestion reagent and heat to 90~95°C.
- (2) 針對金屬材料加入純水，加熱至沸騰萃取。 / For metallic material, add pure water and heat to boiling.

測試報告 Test Report

號碼(No.) : CE/2015/53008

日期(Date) : 2015/05/20

頁數(Page): 7 of 11

喬越實業有限公司

SIL-MORE INDUSTRIAL LTD.

新北市三重區興德路100號16樓

16F, NO. 100, XINGDE RD., SANCHONG DISTRICT, NEW TAIPEI CITY 24158, TAIWAN



鹵素分析流程圖 / Analytical flow chart of halogen content

- 測試人員：陳恩臻 / Name of the person who made measurement: Rita Chen
- 測試負責人：張啓興 / Name of the person in charge of measurement: Troy Chang

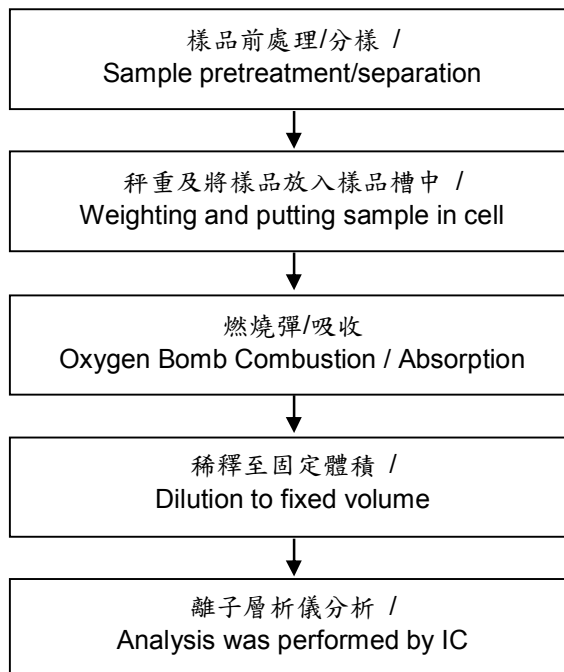

測試報告 Test Report

號碼(No.) : CE/2015/53008

日期(Date) : 2015/05/20

頁數(Page): 8 of 11

喬越實業有限公司

SIL-MORE INDUSTRIAL LTD.

新北市三重區興德路100號16樓

16F, NO. 100, XINGDE RD., SANCHONG DISTRICT, NEW TAIPEI CITY 24158, TAIWAN



六溴環十二烷分析流程圖 / HBCDD analytical flow chart

- 測試人員：翁賜彬 / Name of the person who made measurement: Roman Wong
- 測試負責人：張啓興 / Name of the person in charge of measurement: Troy Chang

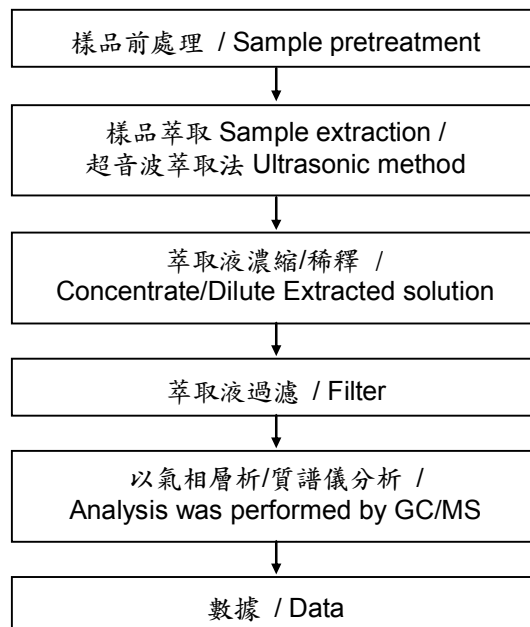

This document is issued by the Company subject to its General Conditions of Service printed overleaf, available on request or accessible at <http://www.sgs.com/en/Terms-and-Conditions.aspx> and, for electronic format documents, subject to Terms and Conditions for Electronic Documents at <http://www.sgs.com/en/Terms-and-Conditions/Termse-Document.aspx>. Attention is drawn to the limitation of liability, indemnification and jurisdiction issues defined therein. Any holder of this document is advised that information contained hereon reflects the Company's findings at the time of its intervention only and within the limits of client's instruction, if any. The Company's sole responsibility is to its Client and this document does not exonerate parties to a transaction from exercising all their rights and obligations under the transaction documents. This document cannot be reproduced, except in full, without prior written approval of the Company. Any unauthorized alteration, forgery or falsification of the content or appearance of this document is unlawful and offenders may be prosecuted to the fullest extent of the law. Unless otherwise stated the results shown in this test report refer only to the sample(s) tested.

測試報告 Test Report

號碼(No.) : CE/2015/53008

日期(Date) : 2015/05/20

頁數(Page): 9 of 11

喬越實業有限公司

SIL-MORE INDUSTRIAL LTD.

新北市三重區興德路100號16樓

16F, NO. 100, XINGDE RD., SANCHONG DISTRICT, NEW TAIPEI CITY 24158, TAIWAN



可塑劑分析流程圖 / Analytical flow chart of phthalate content

- 測試人員：徐毓明 / Name of the person who made measurement: Andy Shu
- 測試負責人：張啓興 / Name of the person in charge of measurement: Troy Chang

【測試方法/Test method: IEC 62321-8】

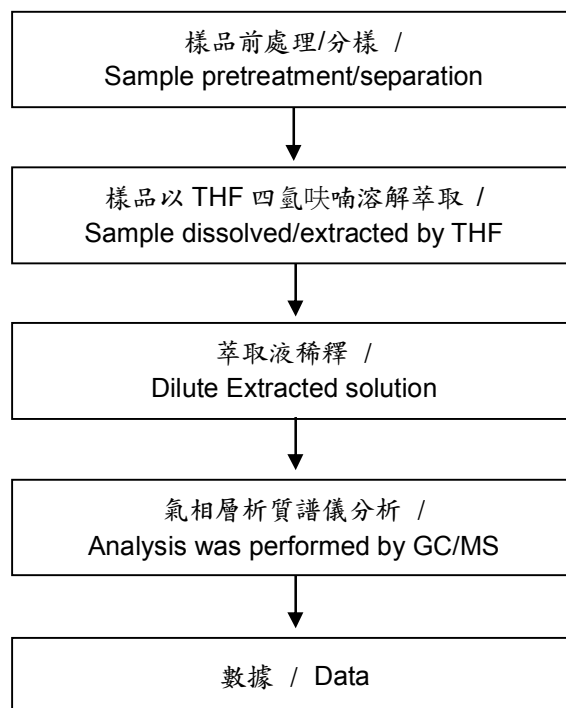

This document is issued by the Company subject to its General Conditions of Service printed overleaf, available on request or accessible at <http://www.sgs.com/en/Terms-and-Conditions.aspx> and, for electronic format documents, subject to Terms and Conditions for Electronic Documents at <http://www.sgs.com/en/Terms-and-Conditions/Termse-Document.aspx>. Attention is drawn to the limitation of liability, indemnification and jurisdiction issues defined therein. Any holder of this document is advised that information contained hereon reflects the Company's findings at the time of its intervention only and within the limits of client's instruction, if any. The Company's sole responsibility is to its Client and this document does not exonerate parties to a transaction from exercising all their rights and obligations under the transaction documents. This document cannot be reproduced, except in full, without prior written approval of the Company. Any unauthorized alteration, forgery or falsification of the content or appearance of this document is unlawful and offenders may be prosecuted to the fullest extent of the law. Unless otherwise stated the results shown in this test report refer only to the sample(s) tested.

測試報告 Test Report

號碼(No.) : CE/2015/53008

日期(Date) : 2015/05/20

頁數(Page): 10 of 11

喬越實業有限公司

SIL-MORE INDUSTRIAL LTD.

新北市三重區興德路100號16樓

16F, NO. 100, XINGDE RD., SANCHONG DISTRICT, NEW TAIPEI CITY 24158, TAIWAN



多溴聯苯/多溴聯苯醚分析流程圖 / PBB/PBDE analytical FLOW CHART

- 測試人員：翁賜彬 / Name of the person who made measurement: Roman Wong
- 測試負責人：張啓興 / Name of the person in charge of measurement: Troy Chang

初次測試程序 / First testing process —————>

選擇性篩檢程序 / Optional screen process>

確認程序 / Confirmation process - - ->

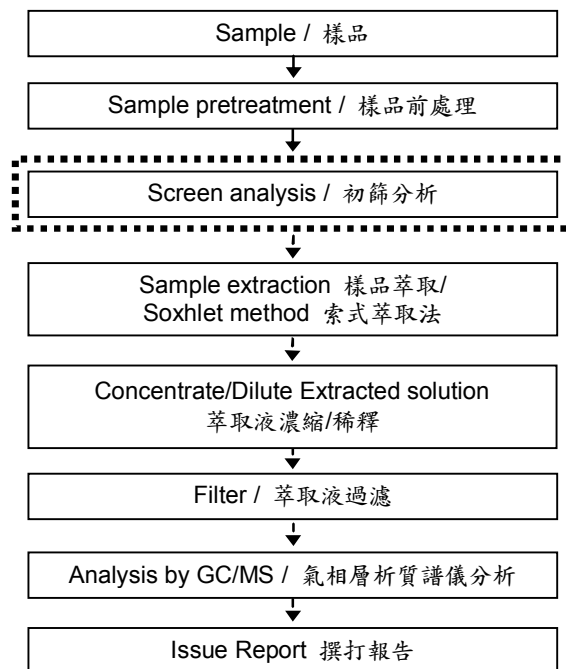

This document is issued by the Company subject to its General Conditions of Service printed overleaf, available on request or accessible at <http://www.sgs.com/en/Terms-and-Conditions.aspx> and, for electronic format documents, subject to Terms and Conditions for Electronic Documents at <http://www.sgs.com/en/Terms-and-Conditions/Termse-Documents.aspx>. Attention is drawn to the limitation of liability, indemnification and jurisdiction issues defined therein. Any holder of this document is advised that information contained hereon reflects the Company's findings at the time of its intervention only and within the limits of client's instruction, if any. The Company's sole responsibility is to its Client and this document does not exonerate parties to a transaction from exercising all their rights and obligations under the transaction documents. This document cannot be reproduced, except in full, without prior written approval of the Company. Any unauthorized alteration, forgery or falsification of the content or appearance of this document is unlawful and offenders may be prosecuted to the fullest extent of the law. Unless otherwise stated the results shown in this test report refer only to the sample(s) tested.

測試報告 Test Report

號碼(No.) : CE/2015/53008

日期(Date) : 2015/05/20

頁數(Page): 11 of 11

喬越實業有限公司

SIL-MORE INDUSTRIAL LTD.

新北市三重區興德路100號16樓

16F, NO. 100, XINGDE RD., SANCHONG DISTRICT, NEW TAIPEI CITY 24158, TAIWAN



* 照片中如有箭頭標示，則表示為實際檢測之樣品/部位。*

(The tested sample / part is marked by an arrow if it's shown on the photo.)

CE/2015/53008



** 報告結尾 (End of Report) **