

Ultrafast Soft Recovery Diode

Features

- Ultrafast Recovery
- 175°C Operating Junction Temperature
- Screw Mounting Only
- Lead-Free Plating

Benefits

- Reduced RFI and EMI
- Higher Frequency Operation
- Reduced Snubbing
- Reduced Parts Count

$$t_{rr} = 35\text{ns}$$

$$I_{F(AV)} = 80\text{Amp}$$

$$V_R = 200\text{V}$$

Description/ Applications

These diodes are optimized to reduce losses and EMI/ RFI in high frequency power conditioning systems. The softness of the recovery eliminates the need for a snubber in most applications. These devices are ideally suited for HF welding, power converters and other applications where switching losses are not significant portion of the total losses.

Absolute Maximum Ratings

Parameters	Max	Units
V_R Cathode to Anode Voltage	200	V
$I_{F(AV)}$ Continuous Forward Current, $T_C = 112^\circ\text{C}$	80	A
I_{FSM} Single Pulse Forward Current, $T_C = 25^\circ\text{C}$	800	
I_{FRM} ① Maximum Repetitive Forward Current	160	
T_J, T_{STG} Operating Junction and Storage Temperatures	- 55 to 175	$^\circ\text{C}$

① Square Wave, 20kHz

Case Styles

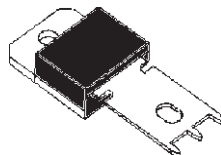

Pow I Rtab

Electrical Characteristics @ T_J = 25°C (unless otherwise specified)

Parameters	Min	Typ	Max	Units	Test Conditions
V _{BR} , V _r Breakdown Voltage, Blocking Voltage	200	-	-	V	I _R = 50μA
V _F Forward Voltage	-	0.98	1.13	V	I _F = 80A
	-	0.79	0.92	V	I _F = 80A, T _J = 175°C
I _R Reverse Leakage Current	-	-	50	μA	V _R = V _R Rated
	-	-	2	mA	T _J = 150°C, V _R = V _R Rated
C _T Junction Capacitance	-	89	-	pF	V _R = 200V
L _S Series Inductance	-	3.5	-	nH	Measured lead to lead 5mm from package body

Dynamic Recovery Characteristics @ T_J = 25°C (unless otherwise specified)

Parameters	Min	Typ	Max	Units	Test Conditions
t _{rr} Reverse Recovery Time	-	-	35	ns	I _F = 1.0A, di _F /dt = 200A/μs, V _R = 30V
	-	32	-		T _J = 25°C
	-	52	-		T _J = 125°C
I _{RRM} Peak Recovery Current	-	4.4	-	A	T _J = 25°C
	-	8.8	-		T _J = 125°C
Q _{rr} Reverse Recovery Charge	-	70	-	nC	T _J = 25°C
	-	-	240	-	T _J = 125°C

Thermal - Mechanical Characteristics

Parameters	Min	Typ	Max	Units
R _{thJC} Thermal Resistance, Junction to Case			0.70	K/W
R _{thCS} ② Thermal Resistance, Case to Heatsink		0.2		
Wt Weight			5.02	g
		0.18		(oz)
T Mounting Torque	1.2		2.4	N * m
	10		20	lbf.in

② Mounting Surface, Flat, Smooth and Greased

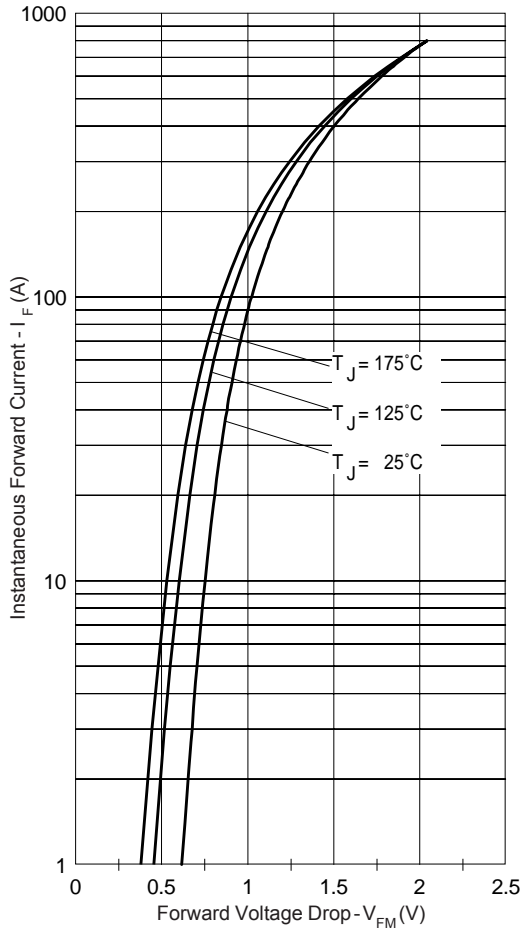

Fig. 1 - Typical Forward Voltage Drop Characteristics

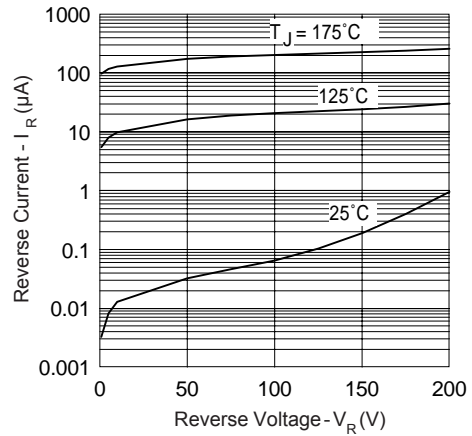

Fig. 2 - Typical Values Of Reverse Current Vs. Reverse Voltage

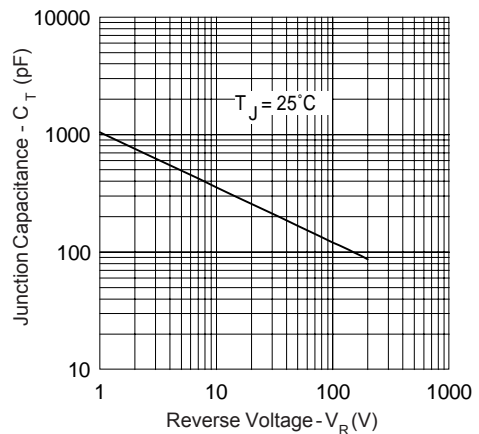

Fig. 3 - Typical Junction Capacitance Vs. Reverse Voltage

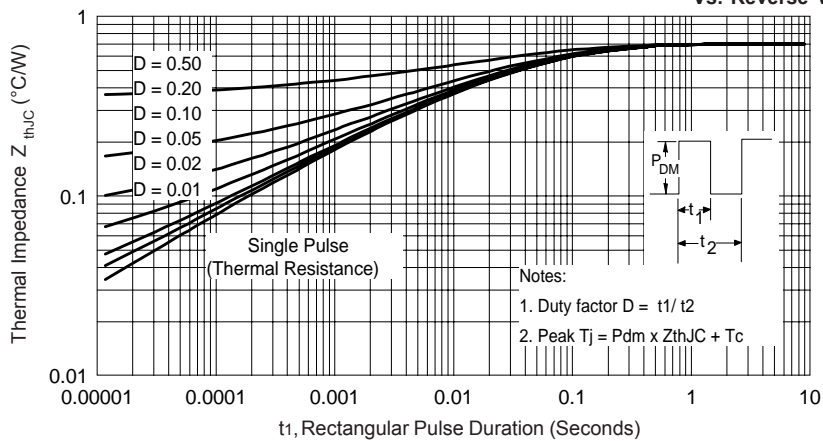

Fig. 4 - Max. Thermal Impedance Z_{thJC} Characteristics

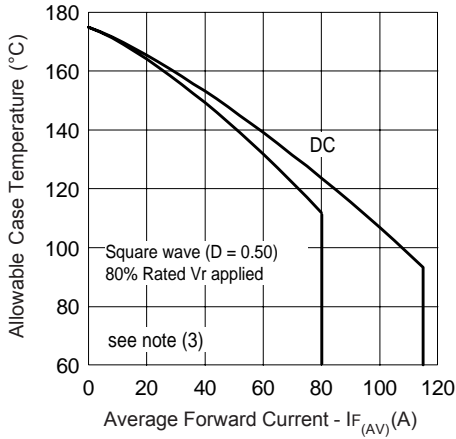

Fig. 5 - Max. Allowable Case Temperature Vs. Average Forward Current

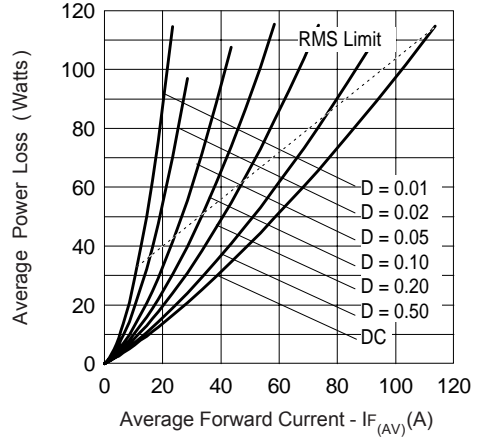

Fig. 6 - Forward Power Loss Characteristics

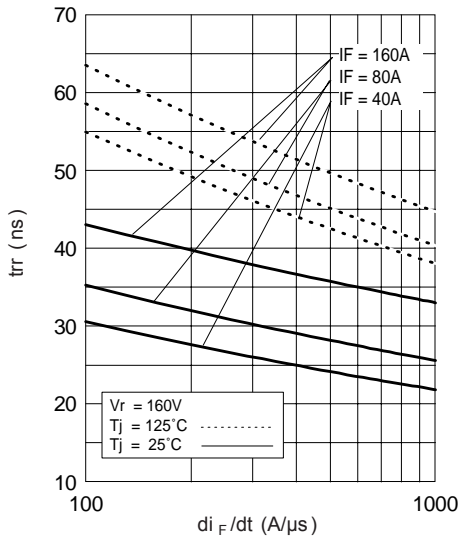

Fig. 7 - Typical Reverse Recovery time vs. di_F/dt

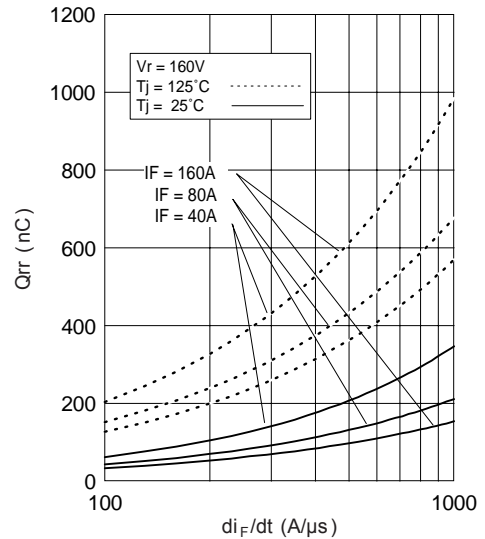

Fig. 8 - Typical Stored Charge vs. di_F/dt

(3) Formula used: $T_c = T_j - (P_d + P_{d_{REV}}) \times R_{thJC}$;
 $P_d = \text{Forward Power Loss} = I_{F(AV)} \times V_{FM} @ (I_{F(AV)} / D)$ (see Fig. 6);
 $P_{d_{REV}} = \text{Inverse Power Loss} = V_{R1} \times I_R (1 - D)$; $I_R @ V_{R1} = 80\% \text{ rated } V_R$

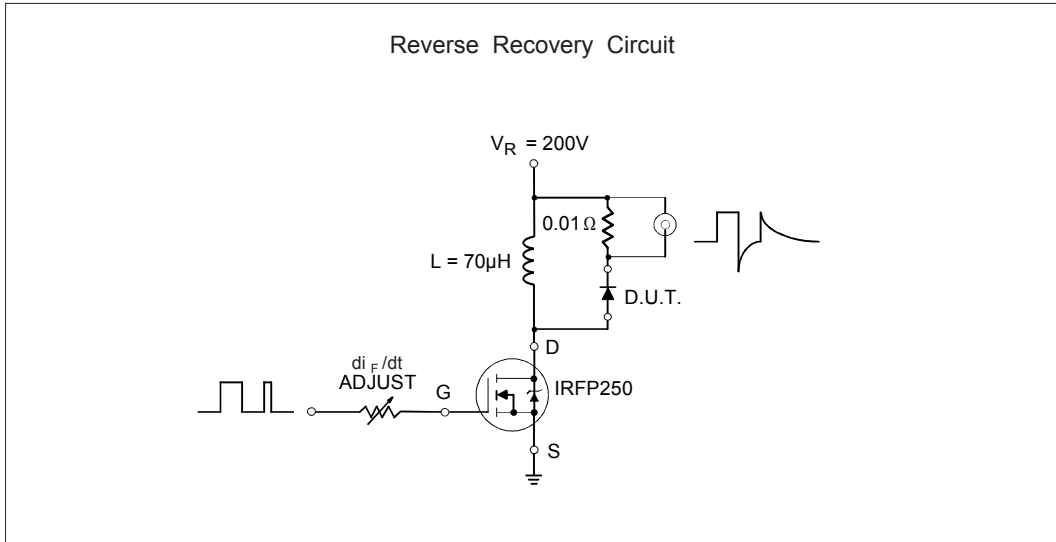

Fig. 9- Reverse Recovery Parameter Test Circuit

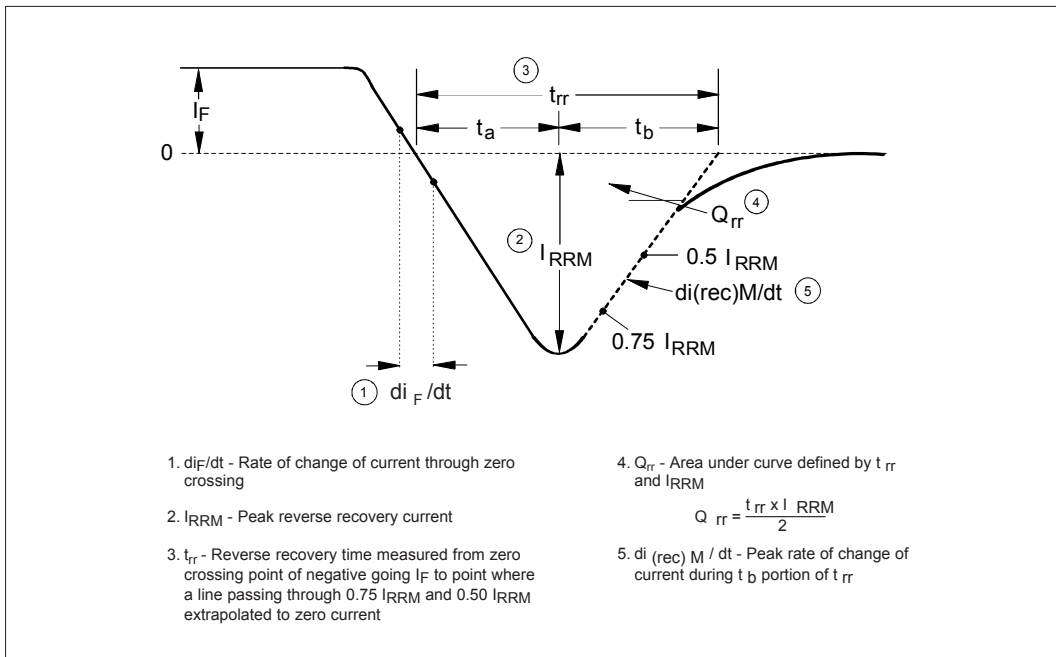
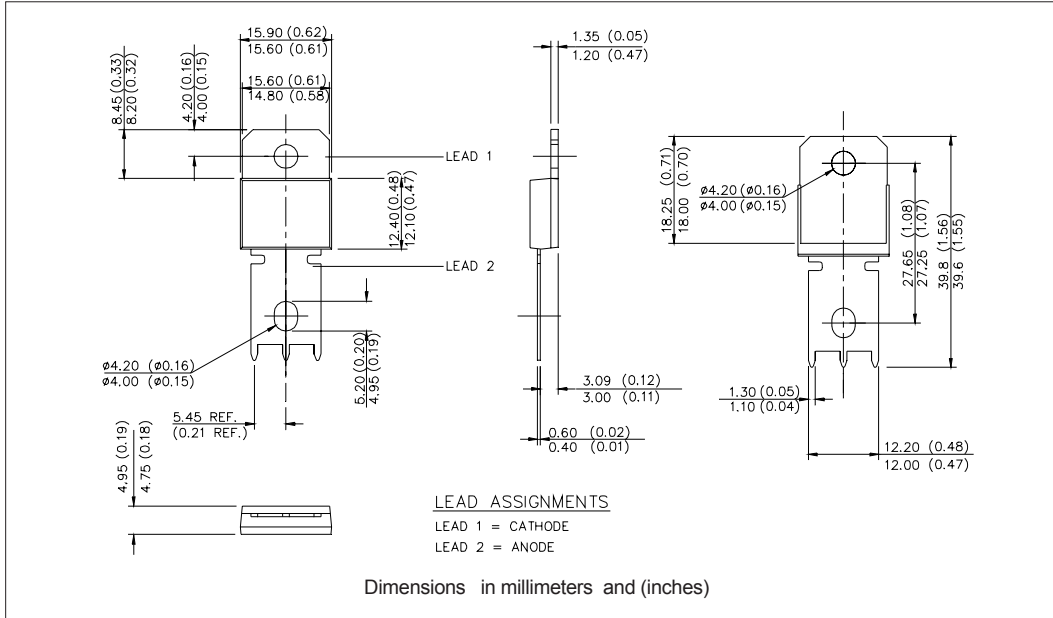

Fig. 10 - Reverse Recovery Waveform and Definitions

Outline Table



Ordering Information Table

Device Code	
80	E B U 02
①	② ③ ④ ⑤
1	- Current Rating (80 = 80A)
2	- Single Diode
3	- Pow <i>IR</i> tab (Ultrafast/ Hyperfast only)
4	- Ultrafast Recovery
5	- Voltage Rating (02 = 200V)

Data and specifications subject to change without notice.
 This product has been designed and qualified for Industrial Level and Lead-Free.
 Qualification Standards can be found on IR's Web site.



Notice

The products described herein were acquired by Vishay Intertechnology, Inc., as part of its acquisition of International Rectifier's Power Control Systems (PCS) business, which closed in April 2007. Specifications of the products displayed herein are pending review by Vishay and are subject to the terms and conditions shown below.

Specifications of the products displayed herein are subject to change without notice. Vishay Intertechnology, Inc., or anyone on its behalf, assumes no responsibility or liability for any errors or inaccuracies.

Information contained herein is intended to provide a product description only. No license, express or implied, by estoppel or otherwise, to any intellectual property rights is granted by this document. Except as provided in Vishay's terms and conditions of sale for such products, Vishay assumes no liability whatsoever, and disclaims any express or implied warranty, relating to sale and/or use of Vishay products including liability or warranties relating to fitness for a particular purpose, merchantability, or infringement of any patent, copyright, or other intellectual property right.

The products shown herein are not designed for use in medical, life-saving, or life-sustaining applications. Customers using or selling these products for use in such applications do so at their own risk and agree to fully indemnify Vishay for any damages resulting from such improper use or sale.