

BCM™ Bus Converter



FEATURES

- 352 Vdc – 44 Vdc 325 W Bus Converter
- High efficiency (>95%) reduces system power consumption
- High power density (>1000 W/in³) reduces power system footprint by >40%
- “Full Chip” V•Chip package enables surface mount, low impedance interconnect to system board
- Contains built-in protection features: undervoltage, overvoltage lockout, overcurrent protection, short circuit protection, overtemperature protection.
- Provides enable/disable control, internal temperature monitoring
- ZVS/ZCS Resonant Sine Amplitude Converter topology
- Can be paralleled to create multi-kW arrays

TYPICAL APPLICATIONS

- High End Computing Systems
- Automated Test Equipment
- Telecom Base Stations

DESCRIPTION

The V•Chip™ bus converter is a high efficiency (>95%) Sine Amplitude Converter™ (SAC™) operating from a 330 to 365 Vdc primary bus to deliver an isolated 41.25 – 45.63 V nominal, unregulated secondary. The SAC offers a low AC impedance beyond the bandwidth of most downstream regulators, meaning that input capacitance normally located at the input of a regulator can be located at the input to the SAC. Since the K factor of the BCM352F440T330A00 is 1/8, that capacitance value can be reduced by a factor of 64x, resulting in savings of board area, materials and total system cost.

The BCM352F440T330A00 is provided in a V•Chip package compatible with standard pick-and-place and surface mount assembly processes. The V•Chip package provides flexible thermal management through its low junction-to-case and junction-to-board thermal resistance. With high conversion efficiency the BCM352F440T330A00 increases overall system efficiency and lowers operating costs compared to conventional approaches.

$V_{IN} = 330 - 365 \text{ V}$	$P_{OUT} = 325 \text{ W(NOM)}$
$V_{OUT} = 41.25 - 45.63 \text{ V(NO LOAD)}$	$K = 1/8$

PART NUMBER	DESCRIPTION
BCM352F440T330A00	-40°C – 125°C T _J , J lead

TYPICAL APPLICATION

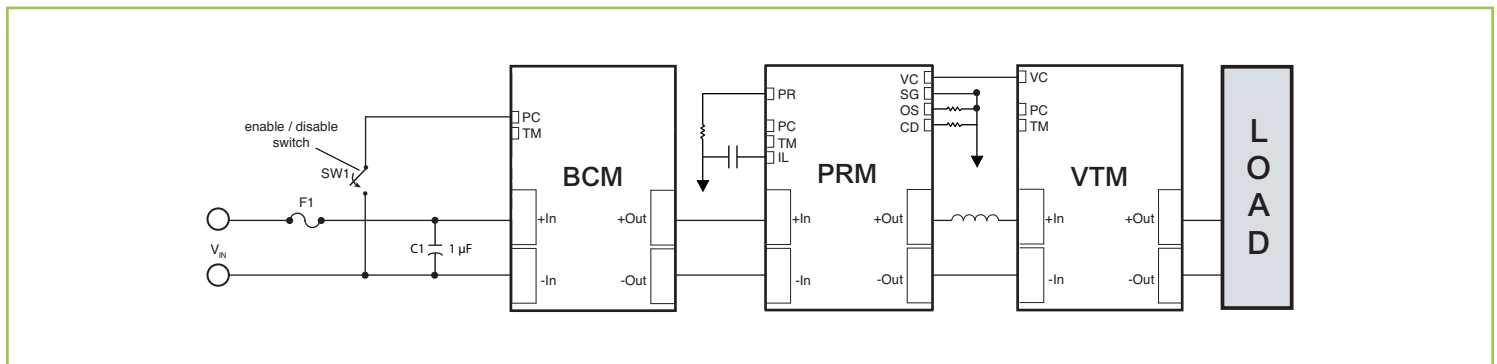

ABSOLUTE MAXIMUM RATINGS

+IN to -IN	-1.0 Vdc – +400 Vdc
PC to -IN	-0.3 Vdc – +20 Vdc
TM to -IN	-0.3 Vdc – +7 Vdc
+IN/-IN to +OUT/-OUT	4242 V (Hi Pot)
+IN/-IN to +OUT/-OUT	500 V (working)
+OUT to -OUT	-1.0 Vdc - +60 Vdc
Temperature during reflow	245°C (MSL 6)

PACKAGE ORDERING INFORMATION

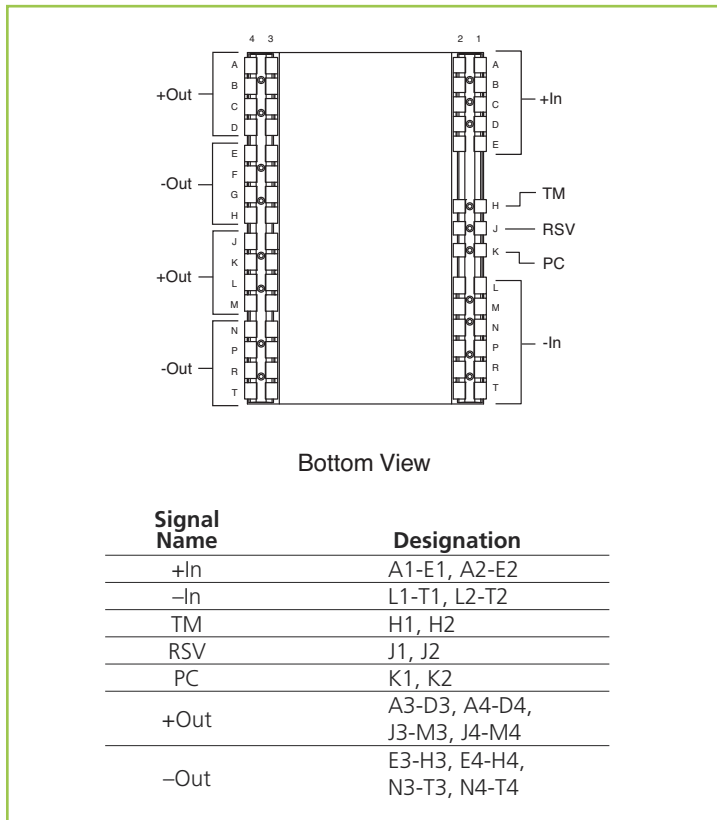

CONTROL PIN SPECIFICATIONS

See section 5.0 for further application details and guidelines.

PC (V•I Chip BCM Primary Control)

The PC pin can enable and disable the BCM. When held below V_{PC_DIS} the BCM shall be disabled. When allowed to float with an impedance to -IN of greater than 50 kΩ the module will start. When connected to another BCM PC pin, the BCMs will start simultaneously when enabled. The PC pin is capable of being driven high by an either external logic signal or internal pull up to 5 V (operating).

TM (V•I Chip BCM Temperature Monitor)

The TM pin monitors the internal temperature of the BCM within an accuracy of +5/-5°C. It has a room temperature setpoint of ~3.0 V and an approximate gain of 10 mV/°C. It can source up to 100 μA and may also be used as a “Power Good” flag to verify that the BCM is operating.

1.0 ELECTRICAL CHARACTERISTICS

Specifications apply over all line and load conditions unless otherwise noted; **Boldface** specifications apply over the temperature range of **-40°C < T_J < 125°C (T-Grade)**; All other specifications are at **T_J = 25°C** unless otherwise noted

ATTRIBUTE	SYMBOL	CONDITIONS / NOTES	MIN	TYP	MAX	UNIT
Voltage range	V _{IN}		330	352	365	Vdc
dV/dt	dV _{IN} /dt				1	V/μs
Quiescent power	P _Q	PC connected to -IN		395	410	mW
No load power dissipation	P _{NL}	V _{IN} = 352 V		6.5	9.5	W
		V _{IN} = 330 to 365 V			12	
Inrush Current Peak	I _{INR_P}	V _{IN} = 365 V C _{OUT} = 100 μF, P _{OUT} = 325 W		2	4.5	A
DC Input Current	I _{IN_DC}	P _{OUT} = 325 W			1	A
K Factor $\left(\frac{V_{OUT}}{V_{IN}}\right)$	K			1/8		
Output Power (Average)	P _{OUT}	V _{IN} = 352 V _{DC} ; See Figure 14			325	W
		V _{IN} = 330 – 365 V _{DC} ; See Figure 14			305	
Output Power (Peak)	P _{OUT_P}	V _{IN} = 352 V _{DC} Average P _{OUT} < = 325 W, T _{peak} < 5 ms			495	W
Output Voltage	V _{OUT}	Section 3.0 No load	41.25		45.63	V
Output Current (Average)	I _{OUT}	P _{out} < = 325 W			7.7	A
Efficiency (Ambient)	η	V _{IN} = 352 V, P _{OUT} = 325 W	94.4	95.7		%
		V _{IN} = 330 V to 365 V, P _{OUT} = 325 W	94.4			
Efficiency (Hot)	η	V _{IN} = 352 V, T _J = 100° C, P _{OUT} = 325 W	94.3	95.3		%
Minimum Efficiency (Over Load Range)	η	60 W < P _{OUT} < 325 W Max	90			%
Output Resistance (Ambient)	R _{OUT}	T _J = 25° C	100	140	180	mΩ
Output Resistance (Hot)	R _{OUT}	T _J = 125° C	150	190	230	mΩ
Output Resistance (Cold)	R _{OUT}	T _J = -40° C	60	115	180	mΩ
Load Capacitance	C _{OUT}				100	μF
Switching Frequency	F _{SW}		1.56	1.65	1.73	MHz
Ripple Frequency	F _{SW_RP}		3.12	3.3	3.46	MHz
Output Voltage Ripple	V _{OUT_PP}	C _{OUT} = 0 μF, P _{OUT} = 325 W, V _{IN} = 352 V, Section 8.0		192	400	mV
V _{IN} to V _{OUT} (Application of V _{IN})	T _{ON1}	V _{IN} = 352 V, C _{PC} = 0; See Figure 16	460	540	620	ms
PC						
PC Voltage (Operating)	V _{PC}		4.7	5	5.3	V
PC Voltage (Enable)	V _{PC_EN}		2	2.5	3	V
PC Voltage (Disable)	V _{PC_DIS}				<2	V
PC Source Current (Startup)	I _{PC_EN}		50	100	300	μA
PC Source Current (Operating)	I _{PC_OP}		2	3.5	5	mA
PC Internal Resistance	R _{PC_SNK}	Internal pull down resistor	50	150	400	kΩ
PC Capacitance (Internal)	C _{PC_INT}	Section 5.0			1000	pF
PC Capacitance (External)	C _{PC_EXT}	External capacitance delays PC enable time			1000	pF
External PC Resistance	R _{PC}	Connected to -V _{IN}	50			kΩ
PC External Toggle Rate	F _{PC_TOG}				1	Hz
PC to V _{OUT} with PC Released	Ton2	V _{IN} = 352 V, Pre-applied C _{PC} = 0, C _{OUT} = 0; See Figure 16	50	100	150	μs
PC to V _{OUT} , Disable PC	T _{PC_DIS}	V _{IN} = 352 V, Pre-applied C _{PC} = 0, C _{OUT} = 0; See Figure 16		4	10	μs

1.0 ELECTRICAL CHARACTERISTICS (CONT.)

Specifications apply over all line and load conditions unless otherwise noted; **Boldface** specifications apply over the temperature range of $-40^{\circ}\text{C} < T_J < 125^{\circ}\text{C}$ (T-Grade); All other specifications are at $T_J = 25^{\circ}\text{C}$ unless otherwise noted

ATTRIBUTE	SYMBOL	CONDITIONS / NOTES	MIN	TYP	MAX	UNIT
TM						
TM accuracy	A_{CTM}		-5		+5	$^{\circ}\text{C}$
TM Gain	A_{TM}			10		$\text{mV}/^{\circ}\text{C}$
TM Source Current	I_{TM}		100			μA
TM Internal Resistance	R_{TM_SNK}		25	40	50	$\text{k}\Omega$
External TM Capacitance	C_{TM}				50	pF
TM Voltage Ripple	V_{TM_PP}	$C_{TM} = 0\mu\text{F}, V_{IN} = 365\text{ V}, P_{OUT} = 325\text{ W}$	200	400	500	mV
PROTECTION						
Negative going OVLO	V_{IN_OVLO-}		365	380	390	V
Positive going OVLO	V_{IN_OVLO+}		380	385	400	V
Negative going UVLO	V_{IN_UVLO-}		270	285	304	V
Positive going UVLO	V_{IN_UVLO+}		285	300	325	V
Output Overcurrent Trip	I_{OCP}	$V_{IN} = 352\text{ V}, 25^{\circ}\text{C}$	10	12	15	A
Short Circuit Protection Trip Current	I_{SCP}		15			A
Short Circuit Protection Response Time	T_{SCP}				1.2	μs
Thermal Shutdown Junction setpoint	T_{J_OTP}		125	130	135	$^{\circ}\text{C}$
GENERAL SPECIFICATION						
Isolation Voltage (Hi-Pot)	V_{HIPOT}		4242			V
Working Voltage (IN – OUT)	$V_{WORKING}$				500	V
Isolation Capacitance	C_{IN_OUT}	Unpowered unit	500	660	800	pF
Isolation Resistance	R_{IN_OUT}		10			$\text{M}\Omega$
MTBF		MIL HDBK 217F, 25°C , GB		4.2		Mhrs
Agency Approvals/Standards		cTUVus				
		CE Mark				
		ROHS 6 of 6				

1.1 APPLICATION CHARACTERISTICS

All specifications are at $T_j = 25^\circ\text{C}$ unless otherwise noted. See associated figures for general trend data.

ATTRIBUTE	SYMBOL	CONDITIONS / NOTES	TYP	UNIT
No Load Power	P_{NL}	$V_{IN} = 352\text{ V}$, PC enabled; See Figure 1	6.5	W
Inrush Current Peak	I_{NR_P}	$C_{OUT} = 100\ \mu\text{F}$, $P_{OUT} = 325\text{ W}$	2	A
Efficiency (Ambient)	η	$V_{IN} = 352\text{ V}$, $P_{OUT} = 325\text{ W}$	95.7	%
Efficiency (Hot – 100°C)	η	$V_{IN} = 352\text{ V}$, $P_{OUT} = 325\text{ W}$	95.3	%
Output Resistance (-40°C)	R_{OUT}	$V_{IN} = 352\text{ V}$	115	$\text{m}\Omega$
Output Resistance (25°C)	R_{OUT}	$V_{IN} = 352\text{ V}$	140	$\text{m}\Omega$
Output Resistance (100°C)	R_{OUT}	$V_{IN} = 352\text{ V}$	190	$\text{m}\Omega$
Output Voltage Ripple	V_{OUT_PP}	$C_{OUT} = 0\ \mu\text{F}$, $P_{OUT} = 325\text{ W}$ @ $V_{IN} = 352$, $V_{IN} = 352\text{ V}$	192	mV
V_{OUT} Transient (Positive)	V_{OUT_TRAN+}	$I_{OUT_STEP} = 0\text{ TO }7.7\text{ A}$, $I_{SLEW} > 10\text{ A/us}$; See Figure 11	3.2	mV
V_{OUT} Transient (Negative)	V_{OUT_TRAN-}	$I_{OUT_STEP} = 7.7\text{ A to }0\text{ A}$, $I_{SLEW} > 10\text{ A/us}$; See Figure 12	2.8	mV
Undervoltage Lockout Response Time Constant	T_{UVLO}		150	μs
Output Overcurrent Response Time Constant	T_{OCP}	$10 < I_{OCP} < 15\text{ A}$	7.5	ms
Overvoltage Lockout Response Time Constant	T_{OVLO}		120	μs
TM Voltage (Ambient)	V_{TM_AMB}	$T_j \approx 27^\circ\text{C}$	3	V

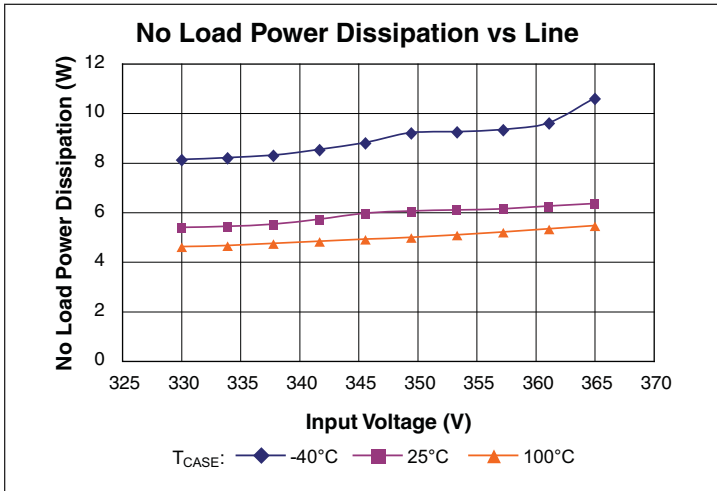

Figure 1 – No load power dissipation vs. V_{IN} ; T_{CASE}

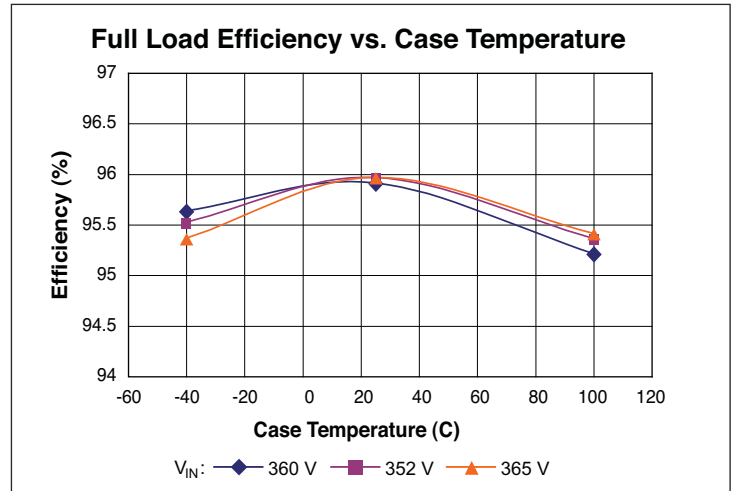

Figure 2 – Full load efficiency vs. temperature; V_{IN}

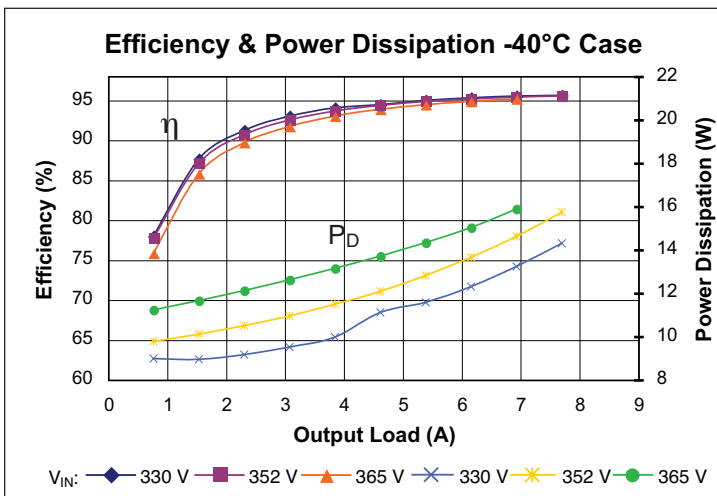

Figure 3 – Efficiency and power dissipation at -40°C (case); V_{IN}

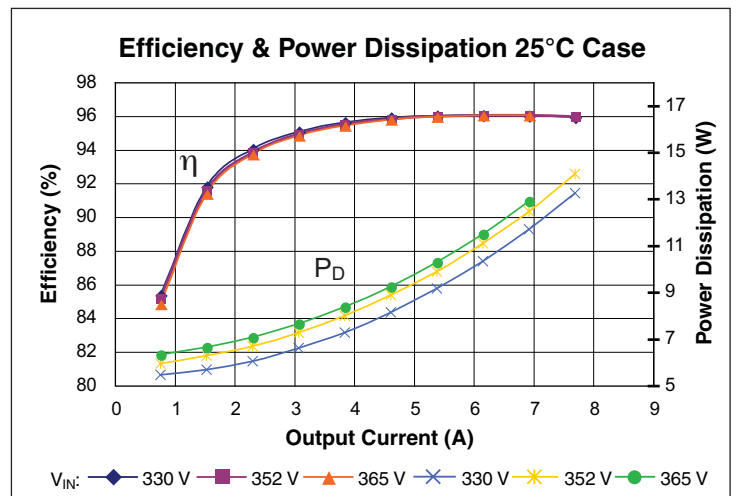

Figure 4 – Efficiency and power dissipation at 25°C (case); V_{IN}

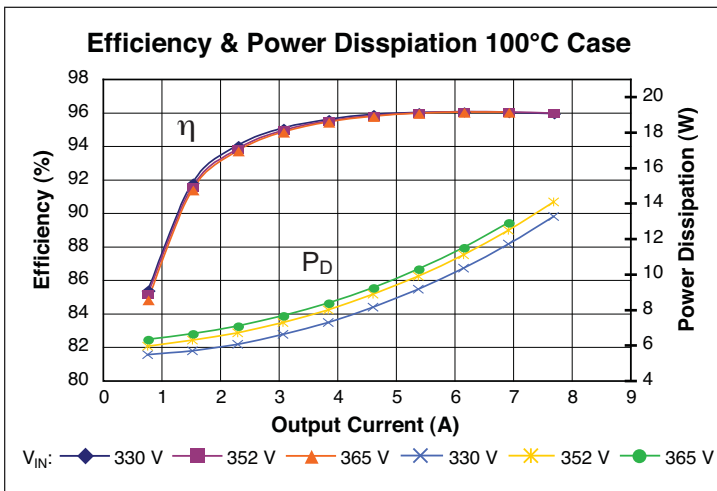

Figure 5 – Efficiency and power dissipation at 100°C (case); V_{IN}

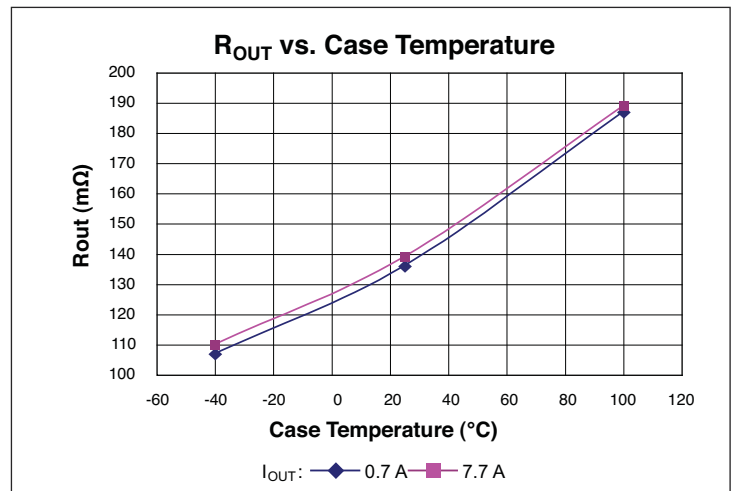

Figure 6 – R_{OUT} vs. temperature vs. I_{OUT}

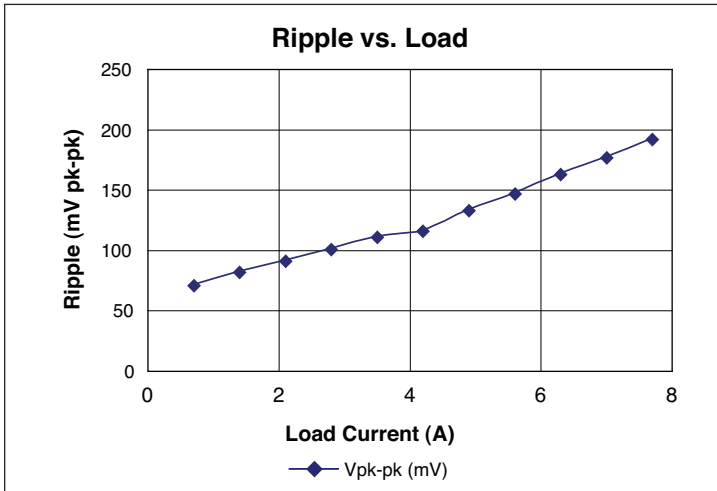

Figure 7 – V_{ripple} vs. I_{OUT} ; 352 V_{in} , no external capacitance

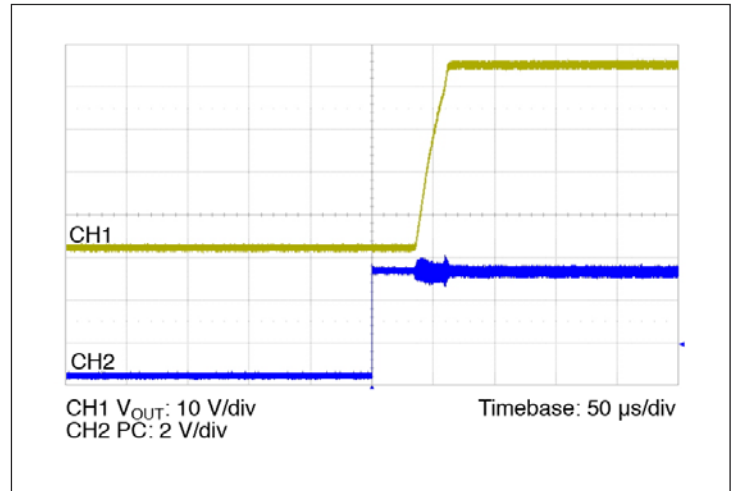

Figure 8 – PC to V_{OUT} startup waveform

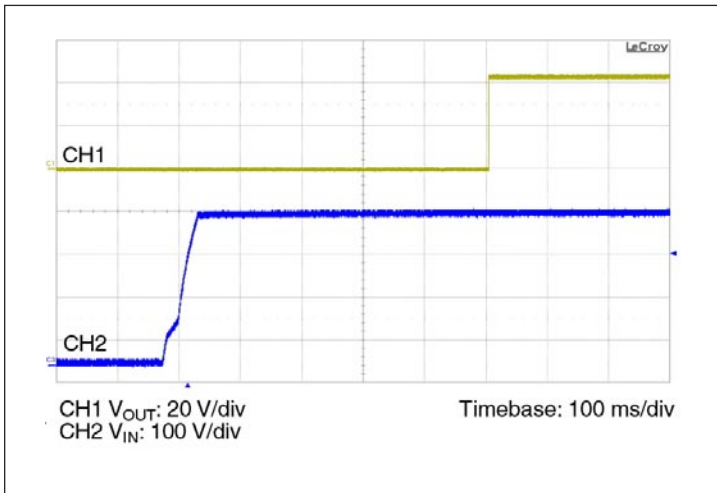

Figure 9 – V_{IN} to V_{OUT} startup waveform

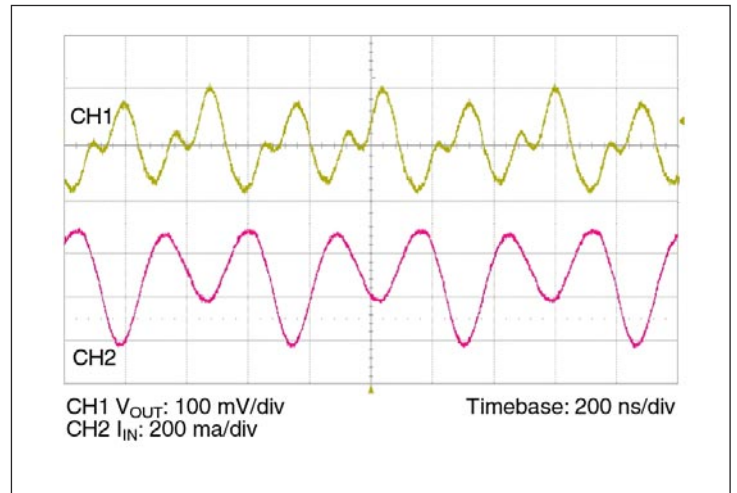

Figure 10 – Output voltage and input current ripple, 352 V_{in} , 325 W no C_{OUT}

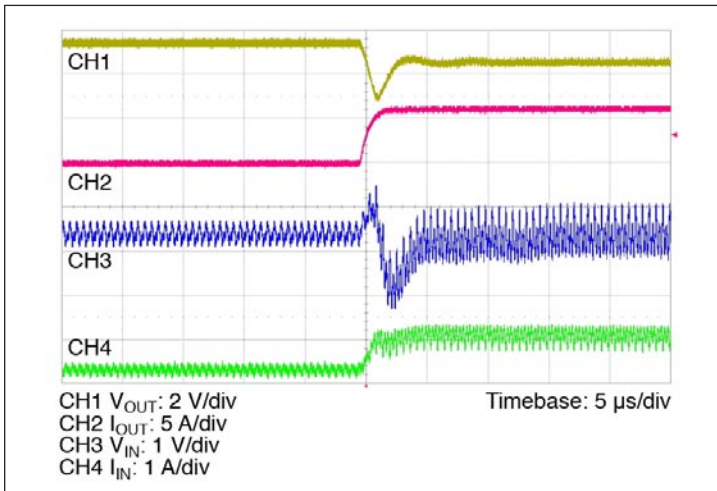

Figure 11 – Positive load transient (0 – 7.7 A)

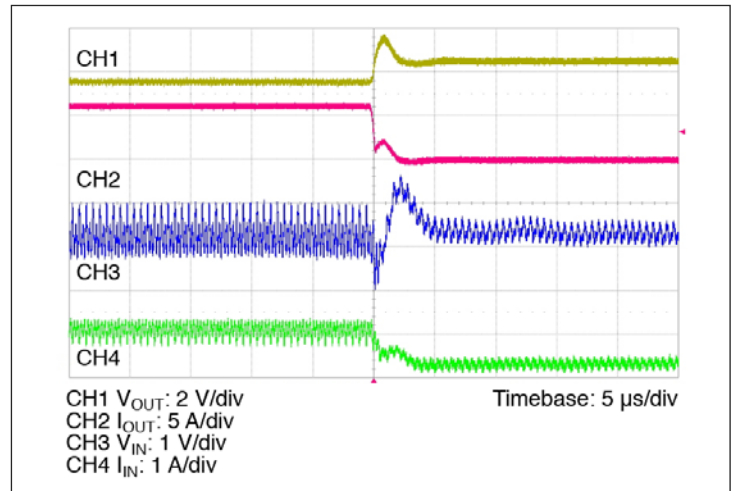

Figure 12 – Negative load transient (7.7 A – 0 A)

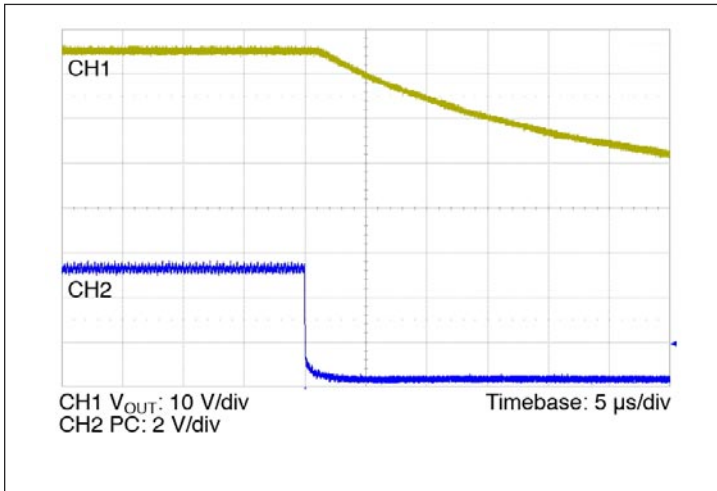

Figure 13 – PC disable waveform, 352 V_{IN} , 100 μF C_{OUT} full load

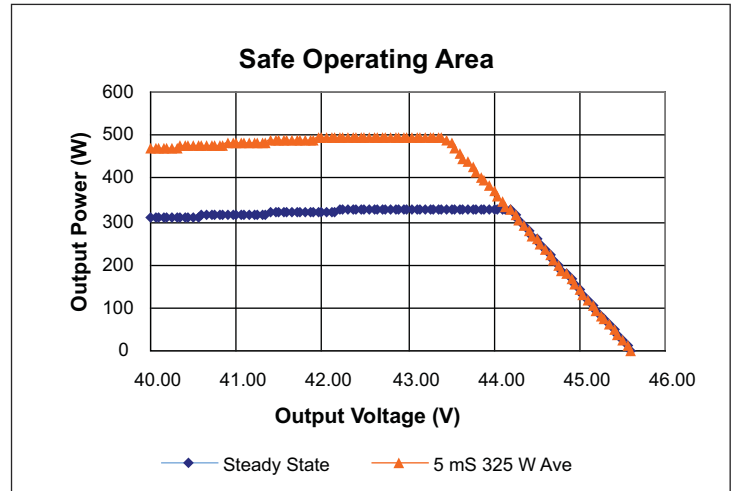

Figure 14 – Safe Operating Area vs. V_{OUT}

2.0 PACKAGE/MECHANICAL SPECIFICATIONS

All specifications are at $T_J = 25^\circ C$ unless otherwise noted. See associated figures for general trend data.

ATTRIBUTE	SYMBOL	CONDITIONS / NOTES	MIN	TYP	MAX	UNIT
Length	L		32.4 / 1.27	32.5 / 1.28	32.6 / 1.29	mm/in
Width	W		21.7 / 0.85	22.0 / 0.87	22.3 / 0.89	mm/in
Height	H		6.48 / 0.255	6.73 / 0.265	6.98 / 0.275	mm/in
Volume	Vol	No Heatsink		4.81 / 0.295		cm ³ /in ³
Footprint	F	No Heatsink		7.3 / 1.1		cm ² /in ²
Power Density	P_D	No Heatsink		1100		W/in ³
				68		W/cm ³
Weight	W			0.5/14		oz/g
Lead Finish		Nickel (0.51-2.03 μm)				μm
		Palladium (0.02-0.15 μm)				
		Gold (0.003-0.05 μm)				
Operating Temperature	T_J		-40		125	$^\circ C$
Storage Temperature	T_{ST}		-40		125	$^\circ C$
Thermal Capacity				9		Ws/ $^\circ C$
Peak Compressive Force Applied to Case (Z-axis)		No J-lead support		5	6	lbs
ESD Rating	ESD _{HBM}	Human Body Model ^[a]	1500			V_{DC}
	ESD _{MM}	Machine Model ^[b]	400			
Peak Temperature During Reflow		MSL 5			225	$^\circ C$
		MSL 6			245	$^\circ C$
Peak Time Above 183 $^\circ C$					150	s
Peak Heating Rate During Reflow				1.5	3	$^\circ C/s$
Peak Cooling Rate Post Reflow				1.5	6	$^\circ C/s$
Thermal Impedance	θ_{JC}	Min Board Heatsinking		1.1	1.5	$^\circ C/W$

^[a] JEDEC JESD 22-A114C.01

^[b] JEDED JESD 22-A115-A

2.1 MECHANICAL DRAWING & RECOMMENDED LAND PATTERN

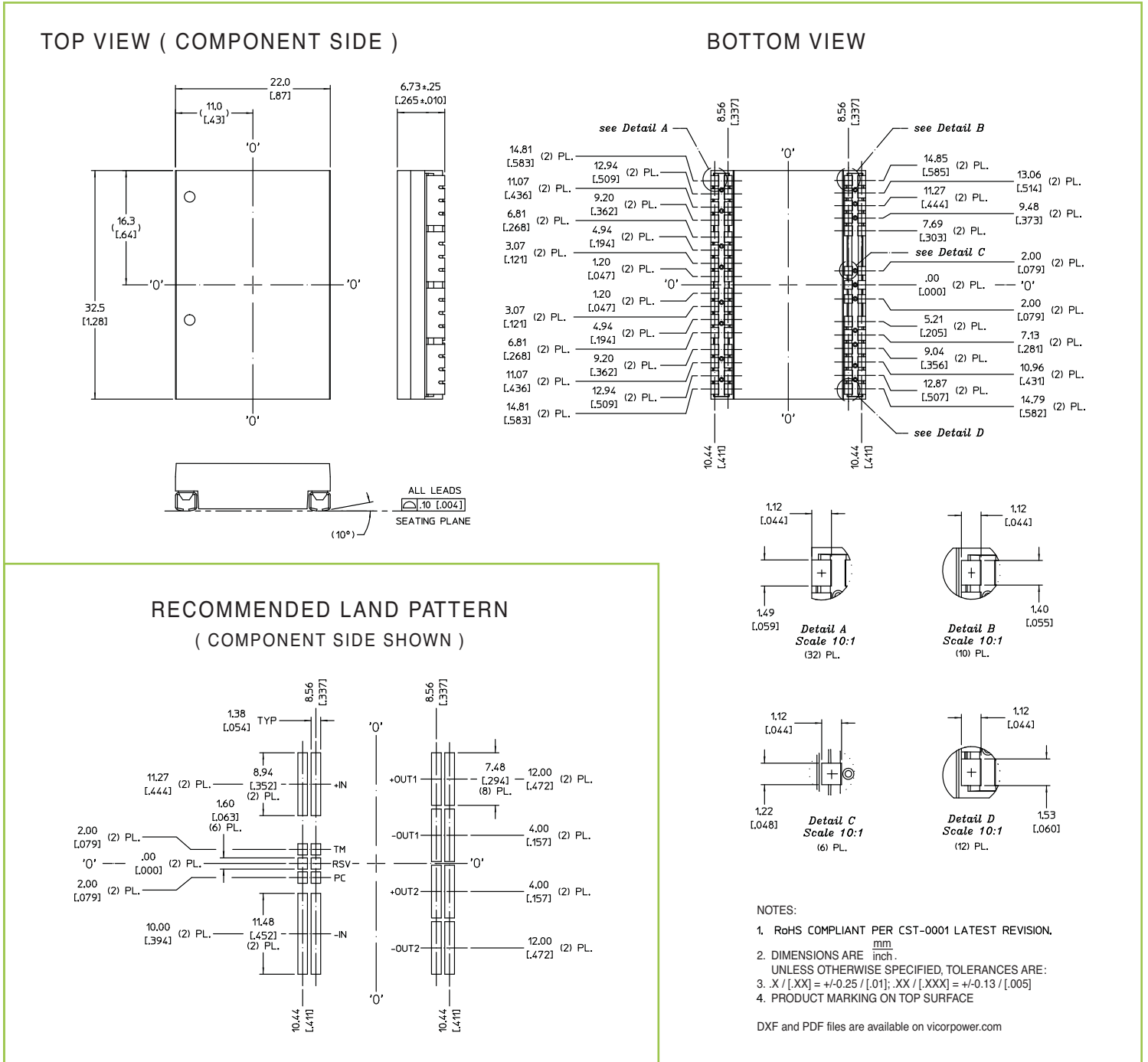

2.3 RECOMMENDED LAND PATTERN FOR PUSH PIN HEAT SINK

RECOMMENDED LAND PATTERN
(NO GROUNDING CLIPS)

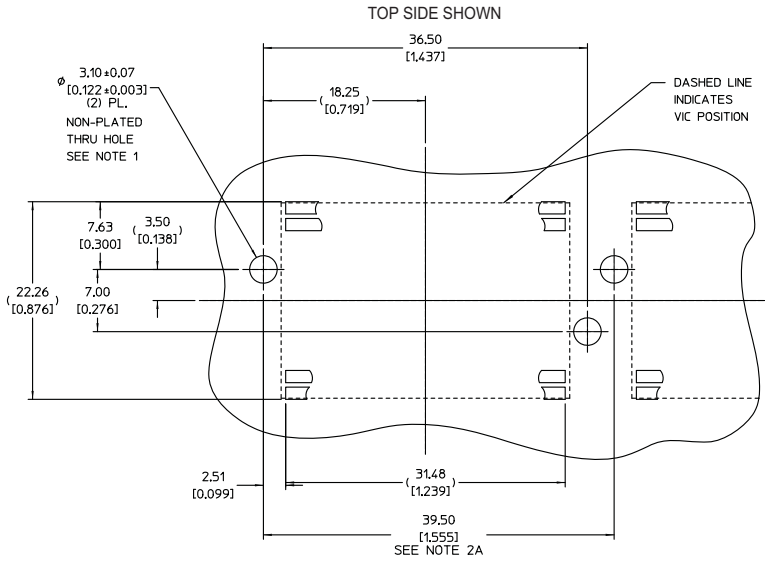

- NOTES:
1. MAINTAIN 3.50 [0.138] DIA. KEEP-OUT ZONE FREE OF COPPER, ALL PCB LAYERS.
 2. (A) MINIMUM RECOMMENDED PITCH IS 39.50 [1.555], THIS PROVIDES 7.00 [0.275] COMPONENT EDGE-TO-EDGE SPACING, AND 0.50 [0.020] CLEARANCE BETWEEN VICOR HEAT SINKS.

(B) MINIMUM RECOMMENDED PITCH IS 41.00 [1.614], THIS PROVIDES 8.50 [0.334] COMPONENT EDGE-TO-EDGE SPACING, AND 2.00 [0.079] CLEARANCE BETWEEN VICOR HEAT SINKS.
 3. V-I CHIP LAND PATTERN SHOWN FOR REFERENCE ONLY; ACTUAL LAND PATTERN MAY DIFFER. DIMENSIONS FROM EDGES OF LAND PATTERN TO PUSH-PIN HOLES WILL BE THE SAME FOR ALL FULL SIZE V-I CHIP PRODUCTS.
 4. RoHS COMPLIANT PER CST-0001 LATEST REVISION.
 5. UNLESS OTHERWISE SPECIFIED: DIMENSIONS ARE MM [INCH]. TOLERANCES ARE:
X.X [X.XX] = ±0.3 [0.01]
X.XX [X.XXX] = ±0.13 [0.005]
 6. PLATED THROUGH HOLES FOR GROUNDING CLIPS (33855) SHOWN FOR REFERENCE. HEATSINK ORIENTATION AND DEVICE PITCH WILL DICTATE FINAL GROUNDING SOLUTION.

RECOMMENDED LAND PATTERN
(With GROUNDING CLIPS)

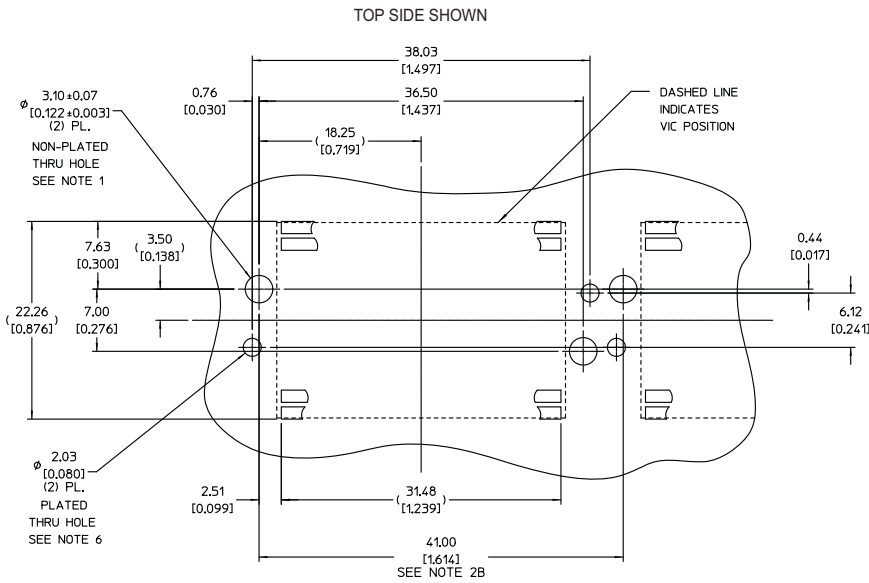

3.0 POWER, VOLTAGE, EFFICIENCY RELATIONSHIPS

Because of the high frequency, fully resonant SAC topology, power dissipation and overall conversion efficiency of BCM converters can be estimated as shown below.

Key relationships to be considered are the following:

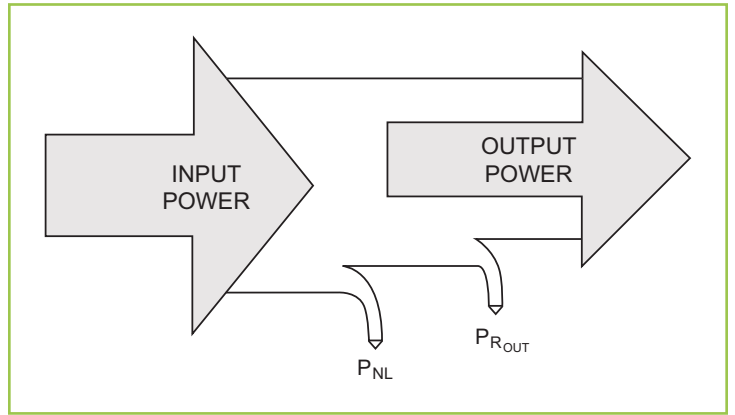

Figure 15 – Power transfer diagram

1. Transfer Function

a. No load condition

$$V_{OUT} = V_{IN} \cdot K \quad \text{Eq. 1}$$

Where K (transformer turns ratio) is constant for each part number

b. Loaded condition

$$V_{OUT} = V_{in} \cdot K - I_{OUT} \cdot R_{OUT} \quad \text{Eq. 2}$$

2. Dissipated Power

The two main terms of power losses in the BCM module are:

- No load power dissipation (P_{NL}) defined as the power used to power up the module with an enabled power train at no load.
- Resistive loss (P_{R_{OUT}}) refers to the power loss across the BCM modeled as pure resistive impedance.

$$P_{DISSIPATED} \approx P_{NL} + P_{R_{OUT}} \quad \text{Eq. 3}$$

Therefore, with reference to the diagram shown in Figure 15

$$P_{OUT} = P_{IN} - P_{DISSIPATED} = P_{IN} - P_{NL} - P_{R_{OUT}} \quad \text{Eq. 4}$$

Notice that R_{OUT} is temperature and input voltage dependent and P_{NL} is temperature dependent (See Figure 15).

The above relations can be combined to calculate the overall module efficiency:

$$\eta = \frac{P_{OUT}}{P_{IN}} = \frac{P_{IN} - P_{NL} - P_{R_{OUT}}}{P_{IN}} = \frac{V_{IN} \cdot I_{IN} - P_{NL} - (I_{OUT})^2 \cdot R_{OUT}}{V_{IN} \cdot I_{IN}} = 1 - \left(\frac{P_{NL} + (I_{OUT})^2 \cdot R_{OUT}}{V_{IN} \cdot I_{IN}} \right) \quad \text{Eq. 5}$$

4.0 OPERATING

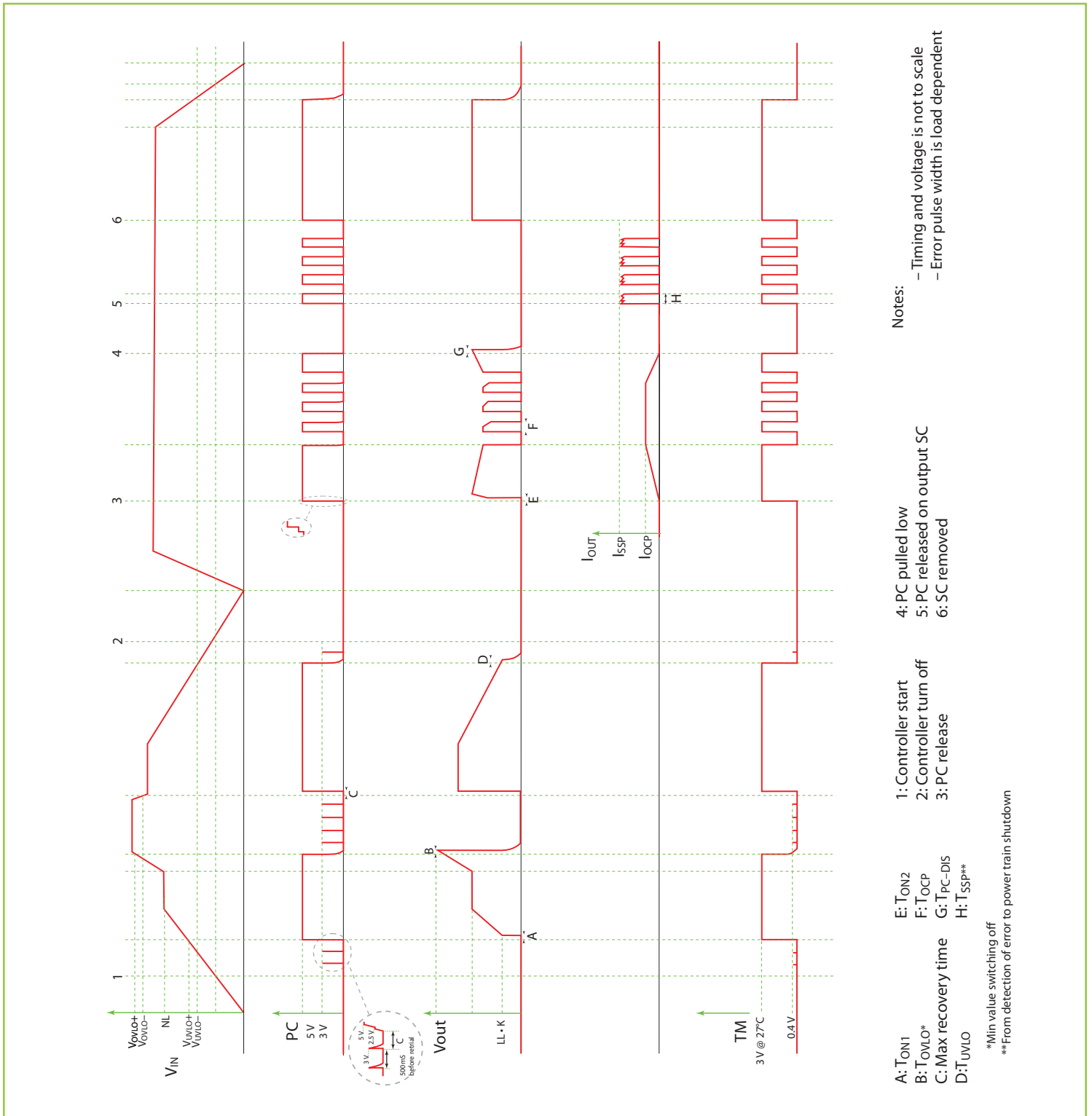

Figure 16 – Timing diagram

5.0 USING THE CONTROL SIGNALS TM AND PC

The PC control pin can be used to accomplish the following functions:

- **Delayed start:** At start-up, PC pin will source a constant 100 uA current to the internal RC network. Adding an external capacitor will allow further delay in reaching the 2.5 V threshold for module start.
- **Synchronized start up:** In a parallel module array, PC pins shall be connected in order to ensure synchronous start of all the units. While every controller has a calibrated 2.5 V reference on PC comparator, many factors might cause different timing in turning on the 100 uA current source on each module, i.e.:
 - Different V_{IN} slew rate
 - Statistical component value distribution
 By connecting all PC pins, the charging transient will be shared and all the modules will be enabled synchronously.
- **Auxiliary voltage source:** Once enabled in regular operational conditions (no fault), each BCM PC provides a regulated 5 V, 2 mA voltage source.
- **Output Disable:** PC pin can be actively pulled down in order to disable module operations. Pull down impedance shall be lower than 400 Ω and toggle rate lower than 1 Hz.
- **Fault detection flag:** The PC 5 V voltage source is internally turned off as soon as a fault is detected. After a minimum disable time, the module tries to re-start, and PC voltage is re-enabled. For system monitoring purposes (microcontroller interface) faults are detected on falling edges of PC signal. It is important to notice that PC doesn't have current sink capability (only 150 k Ω typical pull down is present), therefore, in an array, PC line will not be capable of disabling all the modules if a fault occurs on one of them.

The temperature monitor (TM) pin provides a voltage proportional to the absolute temperature of the converter control IC.

It can be used to accomplish the following functions:

- **Monitor the control IC temperature:** The temperature in Kelvin is equal to the voltage on the TM pin scaled by x100. (i.e. 3.0 V = 300 K = 27°C). It is important to remember that V•I chips are multi-chip modules, whose temperature distribution greatly vary for each part number as well with input/output conditions, thermal management and environmental conditions. Therefore, TM cannot be used to thermally protect the system.
- **Fault detection flag:** The TM voltage source is internally turned off as soon as a fault is detected. After a minimum disable time, the module tries to re-start, and TM voltage is re-enabled.

6.0 FUSE SELECTION

V•I Chips are not internally fused in order to provide flexibility in configuring power systems. Input line fusing of V•I Chips is recommended at system level, in order to provide thermal protection in case of catastrophic failure.

The fuse shall be selected by closely matching system requirements with the following characteristics:

- Current rating (usually greater than maximum BCM current)
- Maximum voltage rating (usually greater than the maximum possible input voltage)
- Ambient temperature
- Nominal melting I^2t
- Recommended fuse: ≤ 2.5 A Bussmann PC-Tron or SOC type 36CFA.

7.0 CURRENT SHARING

The SAC topology bases its performance on efficient transfer of energy through a transformer, without the need of closed loop control. For this reason, the transfer characteristic can be approximated by an ideal transformer with some resistive drop and positive temperature coefficient.

This type of characteristic is close to the impedance characteristic of a DC power distribution system, both in behavior (AC dynamic) and absolute value (DC dynamic).

When connected in an array (with same K factor), the BCM module will inherently share the load current with parallel units, according to the equivalent impedance divider that the system implements from the power source to the point of load.

It is important to notice that, when successfully started, BCMs are capable of bidirectional operations (reverse power transfer is enabled if the BCM input falls within its operating range and the BCM is otherwise enabled). In parallel arrays, because of the resistive behavior, circulating currents are never experienced (energy conservation law).

General recommendations to achieve matched array impedances are (see also AN016 for further details):

- to dedicate common copper planes within the PCB to deliver and return the current to the modules
- to make the PCB layout as symmetric as possible
- to apply same input/output filters (if present) to each unit

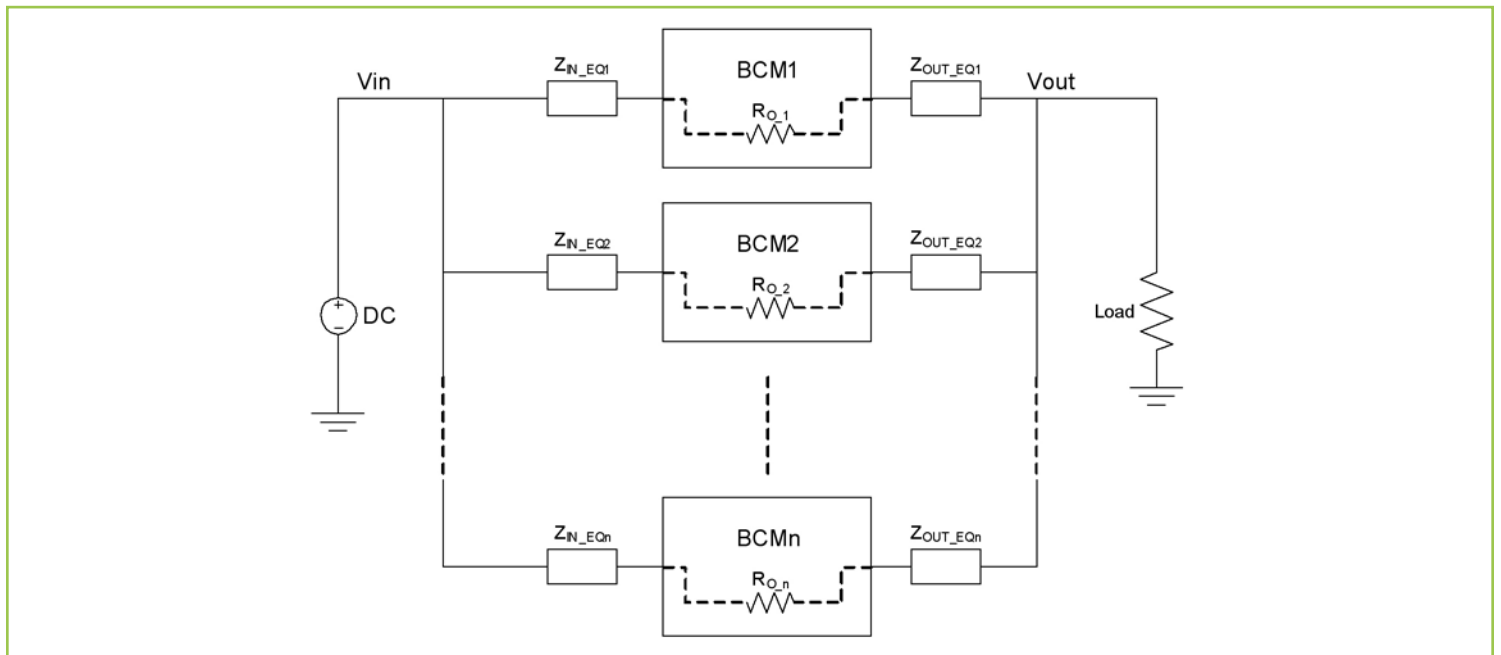

Figure 17 – BCM Array

8.0 INPUT AND OUTPUT FILTER DESIGN

A major advantage of SAC systems versus conventional PWM converters is that the transformers do not require large functional filters. The resonant LC tank, operated at extreme high frequency, is amplitude modulated as a function of input voltage and output current, and efficiently transfers charge through the isolation transformer. A small amount of capacitance, embedded in the input and output stages of the module, is sufficient for full functionality and is key to achieve power density.

This paradigm shift requires system design to carefully evaluate external filters in order to:

Total load capacitance at the output of the BCM shall not exceed the specified maximum. Owing to the wide bandwidth and low output impedance of the BCM, low frequency bypass capacitance and significant energy storage may be more densely and efficiently provided by adding capacitance at the input of the BCM. At frequencies <500 kHz the BCM appears as an impedance of R_{OUT} between the source and load. Within this frequency range capacitance at the input appears as effective capacitance on the output per the relationship defined in Eq. 5.

1. Guarantee low source impedance:

$$C_{OUT} = \frac{C_{IN}}{K^2} \quad \text{Eq. 6}$$

This enables a reduction in the size and number of capacitors used in a typical system.

To take full advantage of the BCM dynamic response, the impedance presented to its input terminals must be low from DC to approximately 5 MHz. The connection of the V•I Chip to its power source should be implemented with minimal distribution inductance. If the interconnect inductance exceeds 100 nH, the input should be bypassed with a RC damper to retain low source impedance and stable operation. With an interconnect inductance of 200 nH, the RC damper may be as high as 1 µF in series with 0.3 Ω. A single electrolytic or equivalent low-Q capacitor may be used in place of the series RC bypass.

2. Further reduce input and/or output voltage ripple without sacrificing dynamic response:

Given the wide bandwidth of the BCM, the source response is generally the limiting factor in the overall system response. Anomalies in the response of the source will appear at the output of the BCM multiplied by its K factor. This is illustrated in Figures 11 and 12.

3. Protect the module from overvoltage transients imposed by the system that would exceed maximum ratings and cause failures:

The V•I Chip input/output voltage ranges shall not be exceeded. An internal overvoltage lockout function prevents operation outside of the normal operating input range. Even during this condition, the powertrain is exposed to the applied voltage and power MOSFETs must withstand it. A criterion for protection is the maximum amount of energy that the input or output switches can tolerate if avalanched.

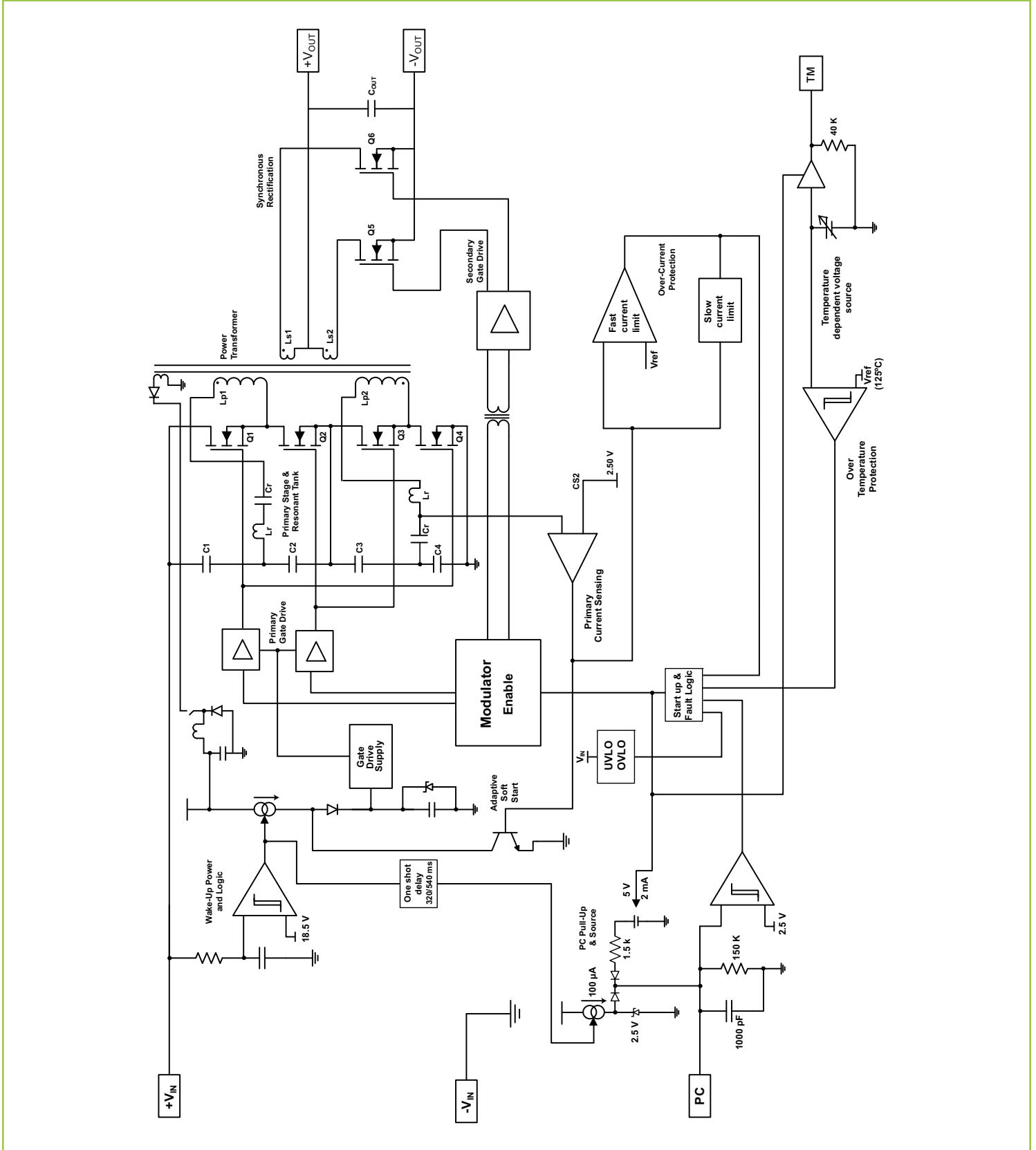

Figure 18 – BCM block diagram

Warranty

Vicor products are guaranteed for two years from date of shipment against defects in material or workmanship when in normal use and service. This warranty does not extend to products subjected to misuse, accident, or improper application or maintenance. Vicor shall not be liable for collateral or consequential damage. This warranty is extended to the original purchaser only.

EXCEPT FOR THE FOREGOING EXPRESS WARRANTY, VICOR MAKES NO WARRANTY, EXPRESS OR IMPLIED, INCLUDING, BUT NOT LIMITED TO, THE WARRANTY OF MERCHANTABILITY OR FITNESS FOR A PARTICULAR PURPOSE.

Vicor will repair or replace defective products in accordance with its own best judgement. For service under this warranty, the buyer must contact Vicor to obtain a Return Material Authorization (RMA) number and shipping instructions. Products returned without prior authorization will be returned to the buyer. The buyer will pay all charges incurred in returning the product to the factory. Vicor will pay all reshipment charges if the product was defective within the terms of this warranty.

Information published by Vicor has been carefully checked and is believed to be accurate; however, no responsibility is assumed for inaccuracies. Vicor reserves the right to make changes to any products without further notice to improve reliability, function, or design. Vicor does not assume any liability arising out of the application or use of any product or circuit; neither does it convey any license under its patent rights nor the rights of others. Vicor general policy does not recommend the use of its components in life support applications wherein a failure or malfunction may directly threaten life or injury. Per Vicor Terms and Conditions of Sale, the user of Vicor components in life support applications assumes all risks of such use and indemnifies Vicor against all damages.

Vicor's comprehensive line of power solutions includes high density AC-DC and DC-DC modules and accessory components, fully configurable AC-DC and DC-DC power supplies, and complete custom power systems.

Information furnished by Vicor is believed to be accurate and reliable. However, no responsibility is assumed by Vicor for its use. Vicor components are not designed to be used in applications, such as life support systems, wherein a failure or malfunction could result in injury or death. All sales are subject to Vicor's Terms and Conditions of Sale, which are available upon request.

Specifications are subject to change without notice.

Intellectual Property Notice

Vicor and its subsidiaries own Intellectual Property (including issued U.S. and Foreign Patents and pending patent applications) relating to the products described in this data sheet. Interested parties should contact Vicor's Intellectual Property Department.

The products described on this data sheet are protected by the following U.S. Patents Numbers: 5,945,130; 6,403,009; 6,710,257; 6,911,848; 6,930,893; 6,934,166; 6,940,013; 6,969,909; 7,038,917; 7,166,898; 7,187,263; 7,361,844; D496,906; D505,114; D506,438; D509,472; and for use under 6,975,098 and 6,984,965

Vicor Corporation
25 Frontage Road
Andover, MA, USA 01810
Tel: 800-735-6200
Fax: 978-475-6715

email

Customer Service: custserv@vicorpower.com
Technical Support: apps@vicorpower.com