

PART No. 1414PHMH6LP

for more information visit  
[www.hammfg.com](http://www.hammfg.com)

Data subject to change without notice

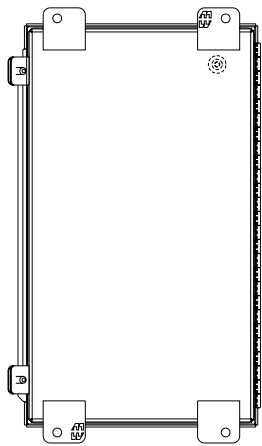

BACK VIEW

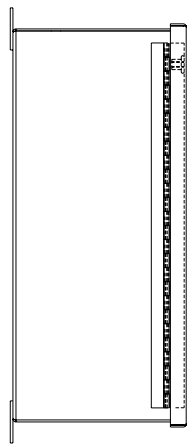

LEFT SIDE VIEW

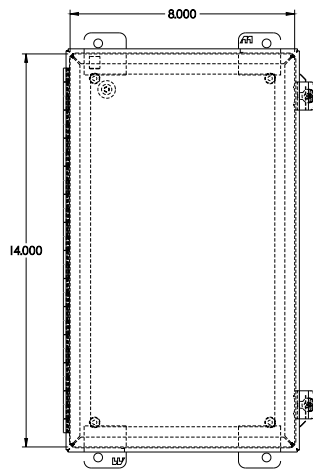

FRONT VIEW

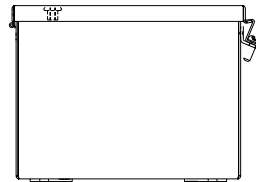

BOTTOM VIEW

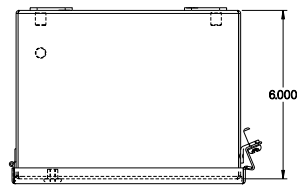

TOP VIEW

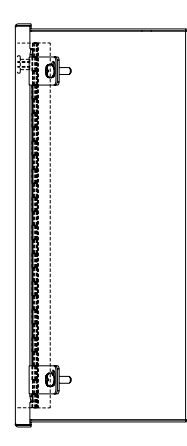

RIGHT SIDE VIEW

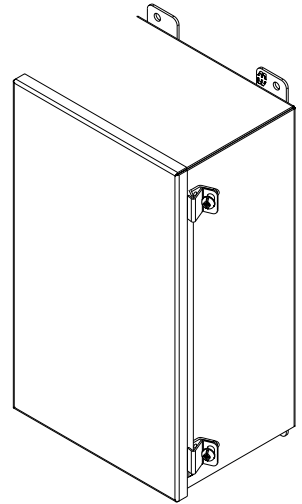

ISOMETRIC VIEW