

PolarHV™ HiPerFET IXFR 24N80P

Power MOSFET

(Electrically Isolated Back Surface)

N-Channel Enhancement Mode
Avalanche Rated
Fast Intrinsic Diode

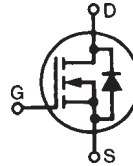

| | | | |
|--------------|---|-----|----|
| V_{DSS} | = | 800 | V |
| I_{D25} | = | 13 | A |
| $R_{DS(on)}$ | ≤ | 420 | mΩ |
| t_{rr} | ≤ | 200 | ns |

| Symbol | Test Conditions | Maximum Ratings | |
|---------------|---|-----------------|------|
| | | | |
| V_{DSS} | $T_J = 25^\circ\text{C}$ to 150°C | 800 | V |
| V_{DGR} | $T_J = 25^\circ\text{C}$ to 150°C ; $R_{GS} = 1\text{ M}\Omega$ | 800 | V |
| V_{GSS} | Continuous | ±30 | V |
| V_{GSM} | Transient | ±40 | V |
| I_{D25} | $T_C = 25^\circ\text{C}$ | 13 | A |
| I_{DM} | $T_C = 25^\circ\text{C}$, pulse width limited by T_{JM} | 55 | A |
| I_{AR} | $T_C = 25^\circ\text{C}$ | 12 | A |
| E_{AR} | $T_C = 25^\circ\text{C}$ | 50 | mJ |
| E_{AS} | $T_C = 25^\circ\text{C}$ | 1.5 | J |
| dv/dt | $I_S \leq I_{DM}$, $di/dt \leq 100\text{ A}/\mu\text{s}$, $V_{DD} \leq V_{DSS}$, $T_J \leq 150^\circ\text{C}$, $R_G = 2\ \Omega$ | 10 | V/ns |
| P_D | $T_C = 25^\circ\text{C}$ | 208 | W |
| T_J | | -55 ... +150 | °C |
| T_{JM} | | 150 | °C |
| T_{stg} | | -55 ... +150 | °C |
| T_L | 1.6 mm (0.062 in.) from case for 10 s | 300 | °C |
| T_{SOLD} | Plastic body for 10 s | 260 | °C |
| V_{ISOL} | 50/60 Hz, RMS, 1 minute | 2500 | V~ |
| F_C | Mounting force | 20..120/4.6..27 | N/lb |
| Weight | | 5 | g |

ISOPLUS247 (IXFR)
E153432

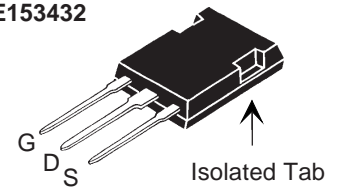

G = Gate D = Drain
S = Source

Features

- Silicon chip on Direct-Copper-Bond substrate
 - High power dissipation
 - Isolated mounting surface
 - 2500V electrical isolation
- International standard package
- Fast recovery diode
- Unclamped Inductive Switching (UIS) rated
- Low package inductance
 - easy to drive and to protect

| Symbol | Test Conditions ($T_J = 25^\circ\text{C}$, unless otherwise specified) | Characteristic Values | | |
|--------------|--|-----------------------|------|--|
| | | Min. | Typ. | Max. |
| BV_{DSS} | $V_{GS} = 0\text{ V}$, $I_D = 250\ \mu\text{A}$ | 800 | | V |
| $V_{GS(th)}$ | $V_{DS} = V_{GS}$, $I_D = 4\text{ mA}$ | 3.0 | | 5.0 V |
| I_{GSS} | $V_{GS} = \pm 30\text{ V}$, $V_{DS} = 0\text{ V}$ | | | ±100 nA |
| I_{DSS} | $V_{DS} = V_{DSS}$ $V_{GS} = 0\text{ V}$ $T_J = 125^\circ\text{C}$ | | | 25 μA 1000 μA |
| $R_{DS(on)}$ | $V_{GS} = 10\text{ V}$, $I_D = I_T$ (note 1) Pulse test, $t \leq 300\ \mu\text{s}$, duty cycle $d \leq 2\%$ | | | 420 mΩ |

Advantages

- Easy to mount
- Space savings
- High power density

| Symbol | Test Conditions | Characteristic Values ($T_J = 25^\circ\text{C}$, unless otherwise specified) | | |
|--------------|---|---|------|--------------------|
| | | Min. | Typ. | Max. |
| g_{fs} | $V_{DS} = 20\text{ V}; I_D = I_T$, pulse test | 15 | 25 | S |
| C_{iss} | $V_{GS} = 0\text{ V}, V_{DS} = 25\text{ V}, f = 1\text{ MHz}$ | | 7200 | pF |
| C_{oss} | | | 470 | pF |
| C_{rss} | | | 26 | pF |
| $t_{d(on)}$ | $V_{GS} = 10\text{ V}, V_{DS} = 0.5 V_{DSS}, I_D = I_T$ $R_G = 2\ \Omega$ (External) | | 32 | ns |
| t_r | | | 27 | ns |
| $t_{d(off)}$ | | | 75 | ns |
| t_f | | | 24 | ns |
| $Q_{g(on)}$ | $V_{GS} = 10\text{ V}, V_{DS} = 0.5 V_{DSS}, I_D = I_T$ | | 105 | nC |
| Q_{gs} | | | 30 | nC |
| Q_{gd} | | | 33 | nC |
| R_{thJC} | | | 0.6 | $^\circ\text{C/W}$ |
| R_{thCS} | | 0.15 | | $^\circ\text{C/W}$ |

Note 1: Test current $I_T = 12\text{ A}$

Source-Drain Diode

| Symbol | Test Conditions | Characteristic Values ($T_J = 25^\circ\text{C}$, unless otherwise specified) | | |
|----------|---|---|------|---------------|
| | | Min. | Typ. | Max. |
| I_S | $V_{GS} = 0\text{ V}$ | | | 24 A |
| I_{SM} | Repetitive | | | 55 A |
| V_{SD} | $I_F = I_S, V_{GS} = 0\text{ V}$, Pulse test, $t \leq 300\ \mu\text{s}$, duty cycle $d \leq 2\%$ | | | 1.5 V |
| t_{rr} | $I_F = 25\text{ A}, -di/dt = 100\text{ A}/\mu\text{s}$ $V_R = 100\text{ V}, V_{GS} = 0\text{ V}$ | | | 250 ns |
| Q_{RM} | | | 0.8 | μC |
| I_{RM} | | | 6.0 | A |

ISOPLUS247 (IXFR) Outline

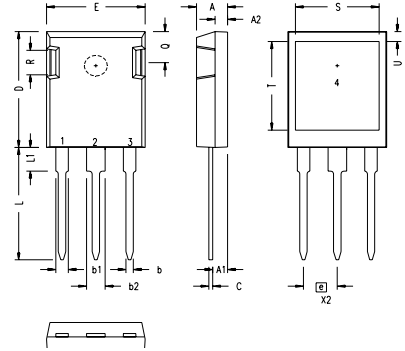

| SYM | INCHES | | MILLIMETERS | |
|-----|----------|------|-------------|-------|
| | MIN | MAX | MIN | MAX |
| A | .190 | .205 | 4.83 | 5.21 |
| A1 | .090 | .100 | 2.29 | 2.54 |
| A2 | .075 | .085 | 1.91 | 2.16 |
| b | .045 | .055 | 1.14 | 1.40 |
| b1 | .075 | .084 | 1.91 | 2.13 |
| b2 | .115 | .123 | 2.92 | 3.12 |
| C | .024 | .031 | 0.61 | 0.80 |
| D | .819 | .840 | 20.80 | 21.34 |
| E | .620 | .635 | 15.75 | 16.13 |
| e | .215 BSC | | 5.45 BSC | |
| L | .780 | .800 | 19.81 | 20.32 |
| L1 | .150 | .170 | 3.81 | 4.32 |
| Q | .220 | .244 | 5.59 | 6.20 |
| R | .170 | .190 | 4.32 | 4.83 |
| S | .520 | .540 | 13.21 | 13.72 |
| T | .620 | .640 | 15.75 | 16.26 |
| U | .065 | .080 | 1.65 | 2.03 |

- 1 - GATE
- 2 - DRAIN (COLLECTOR)
- 3 - SOURCE (EMITTER)
- 4 - NO CONNECTION

NOTE: This drawing will meet all dimensions requirement of JEDEC outline TO-247AD except screw hole.

IXYS reserves the right to change limits, test conditions, and dimensions.

IXYS MOSFETs and IGBTs are covered by 4,835,592 4,931,844 5,049,961 5,237,481 6,162,665 6,404,065 B1 6,683,344 6,727,585 7,005,734 B2
one or more of the following U.S. patents: 4,850,072 5,017,508 5,063,307 5,381,025 6,259,123 B1 6,534,343 6,710,405B2 6,759,692
4,881,106 5,034,796 5,187,117 5,486,715 6,306,728 B1 6,583,505 6,710,463 6,771,478 B2

Fig. 1. Output Characteristics @ 25°C

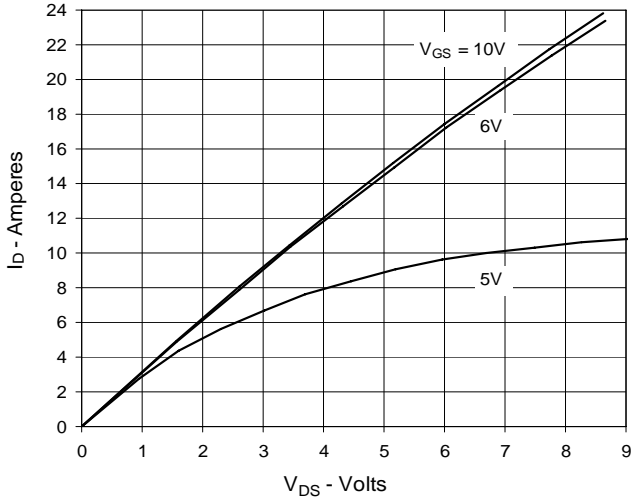

Fig. 2. Extended Output Characteristics @ 25°C

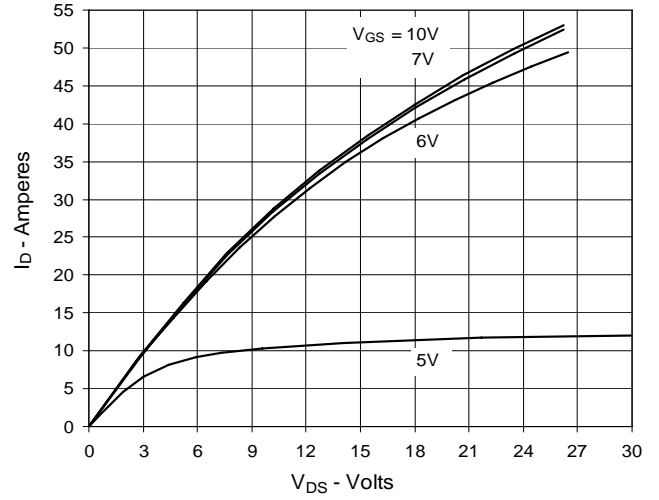

Fig. 3. Output Characteristics @ 125°C

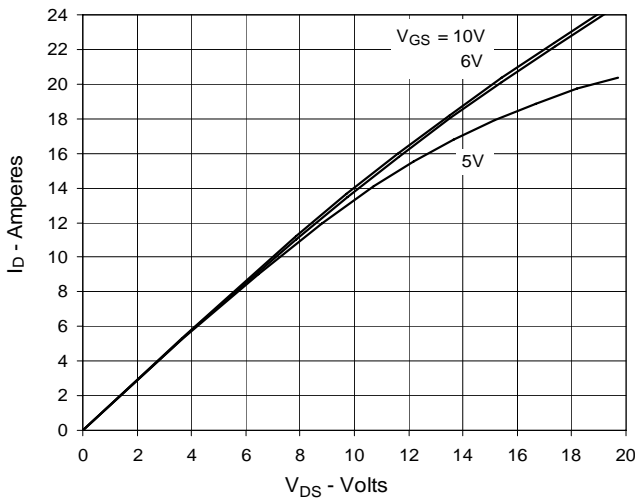

Fig. 4. $R_{DS(on)}$ Normalized to $I_D = 12A$ Value vs. Junction Temperature

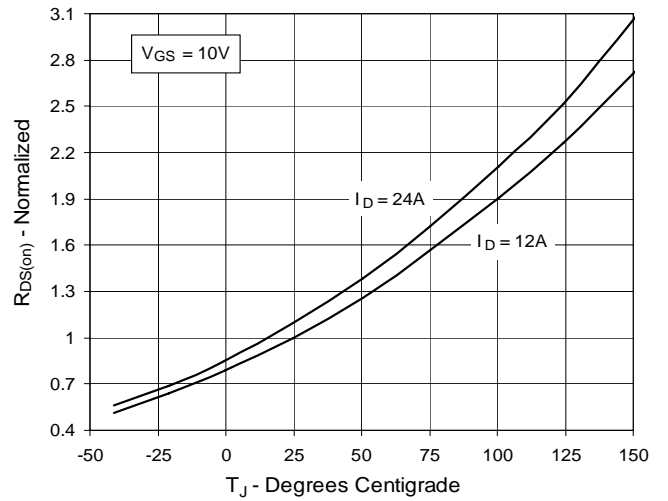

Fig. 5. $R_{DS(on)}$ Normalized to $I_D = 12A$ Value vs. Drain Current

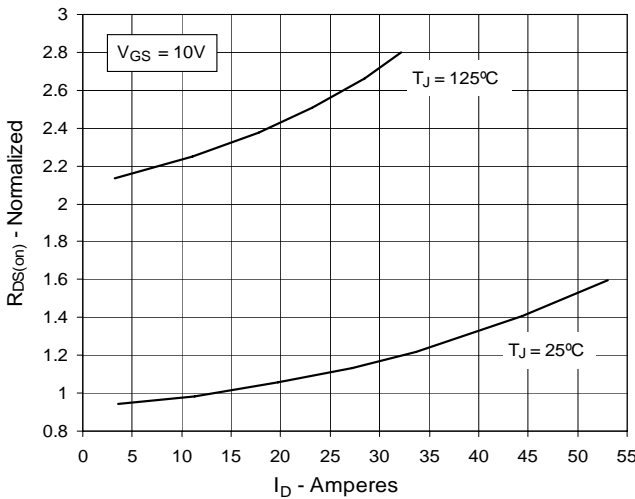

Fig. 6. Maximum Drain Current vs. Case Temperature

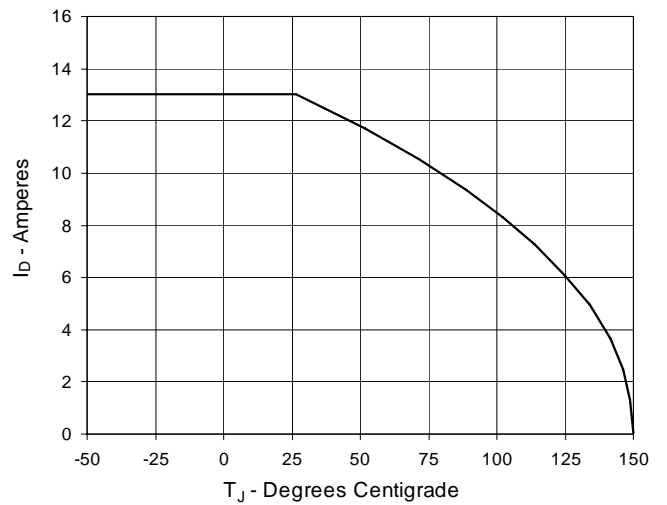

Fig. 7. Input Admittance

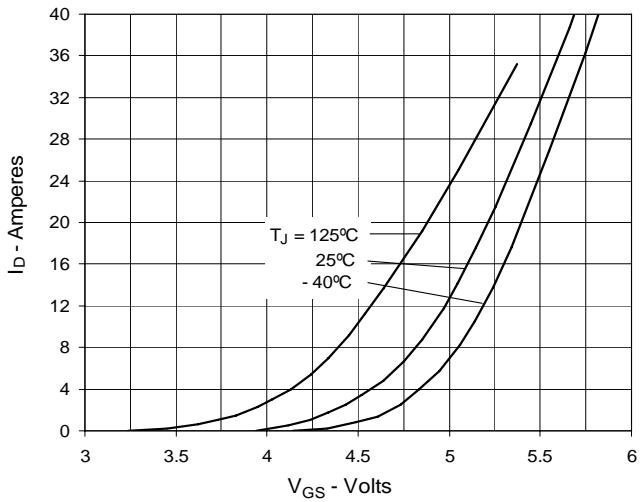

Fig. 8. Transconductance

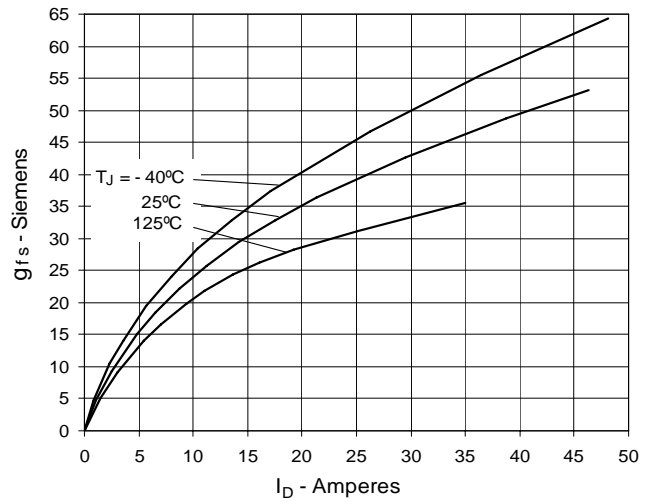

Fig. 9. Forward Voltage Drop of Intrinsic Diode

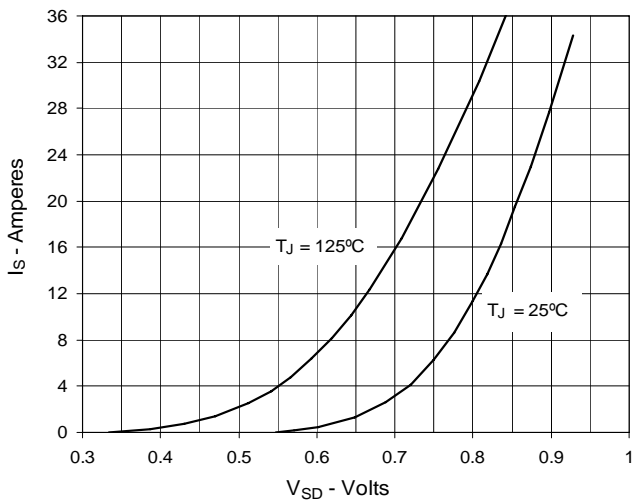

Fig. 10. Gate Charge

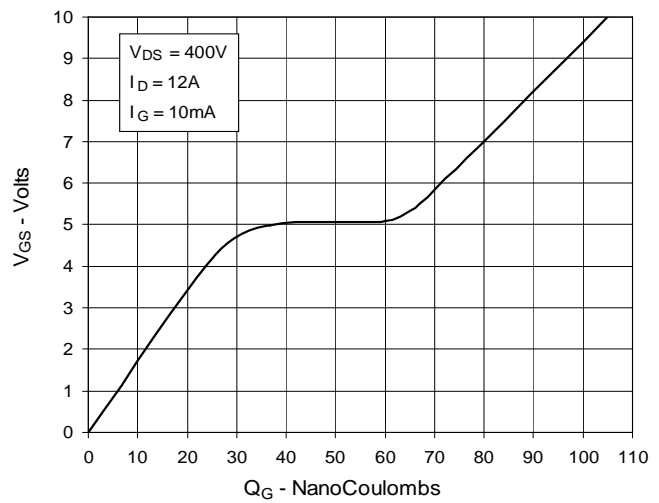

Fig. 11. Capacitance

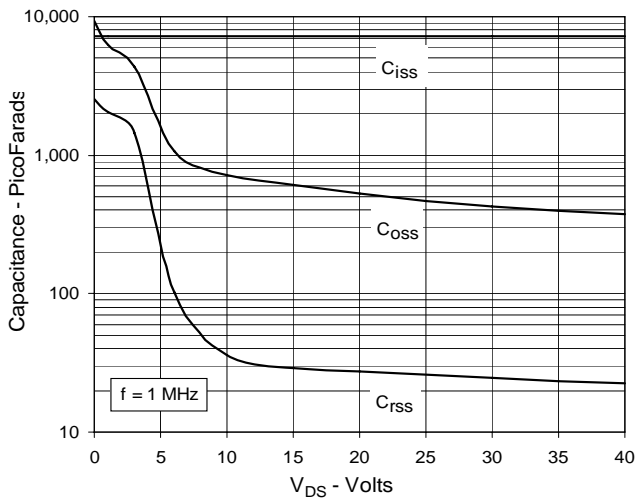

Fig. 12. Maximum Transient Thermal Resistance

