

# SF1189B

## 280.00 MHz SAW Filter

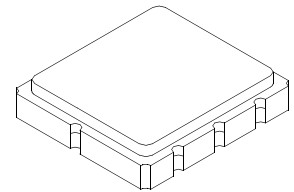

SM5050-8

- **Designed for WLAN IF Applications**
- **Low Insertion Loss**
- **5.0 x 5.0 x 1.7 mm Surface-Mount Case**
- **Single Ended or Differential Input and Output**

### Absolute Maximum Ratings

Rating	Value	Units
Maximum Incident Power in Passband	+10	dBm
Max. DC voltage between any 2 terminals	0	VDC
Storage Temperature Range	-40 to +85	°C
Max Soldering Profile	265°C for 10 s	

Characteristic	Sym	Notes	Min	Typ	Max	Units
Nominal Center Frequency	$f_C$	1	280.0			MHz
Passband	Insertion Loss at $f_C$	IL		8.2	8.5	dB
		3 dB Passband	$BW_3$	1, 2	18.5	20.1
	Amplitude Ripple over $f_C \pm 9.0$ MHz			2.0	2.5	dB <sub>P-P</sub>
	Group Delay Variation over $f_C \pm 9.0$	GDV			72	100
Rejection	$f_C - 60$ to $f_C - 40$ MHz	$f_C - 40$ to $f_C - 22$ MHz	1, 2, 3	40	47	dB
		$f_C - 22$ to $f_C - 17$ MHz		38	41	
		$f_C + 17$ to $f_C + 22$ MHz		30	39	
		$f_C + 22$ to $f_C + 40$ MHz		25	36	
		$f_C + 40$ to $f_C + 60$ MHz		34	36	
				40	41	
Operating Temperature Range	$T_A$	1	-10		+85	°C

Differential Input / Output Impedance Match	External L-C
Case Style	SM5050-8 5 X 5 mm Nominal Footprint
Lid Symbolization (YY=year, WW=week, S=shift)	453, YYWWS

### Electrical Connections

Connection	Terminals
Port 1 Hot	2
Port 1 Gnd or Return	1
Port 2 Hot	6
Port 2 Gnd or Return	5
Case Ground	All others

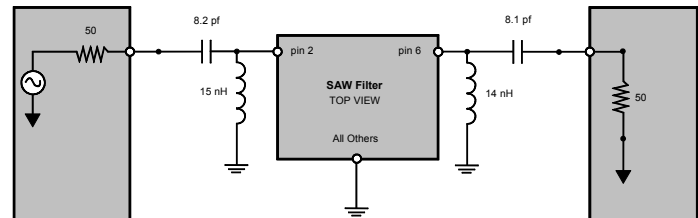

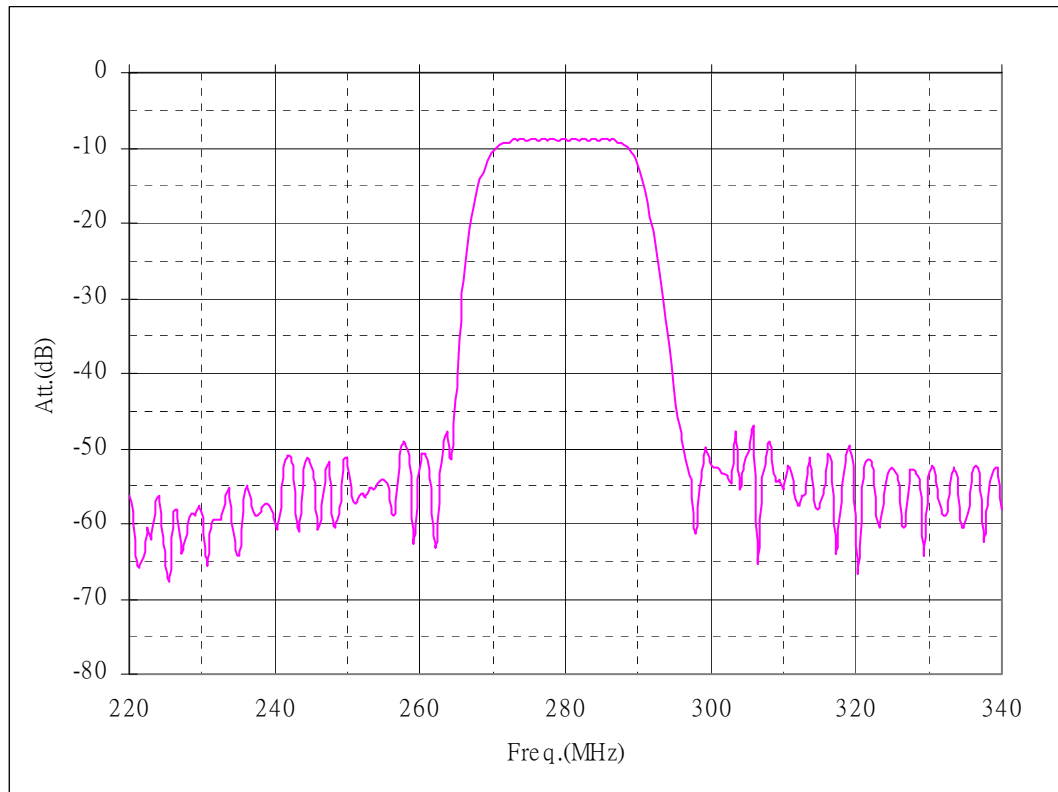
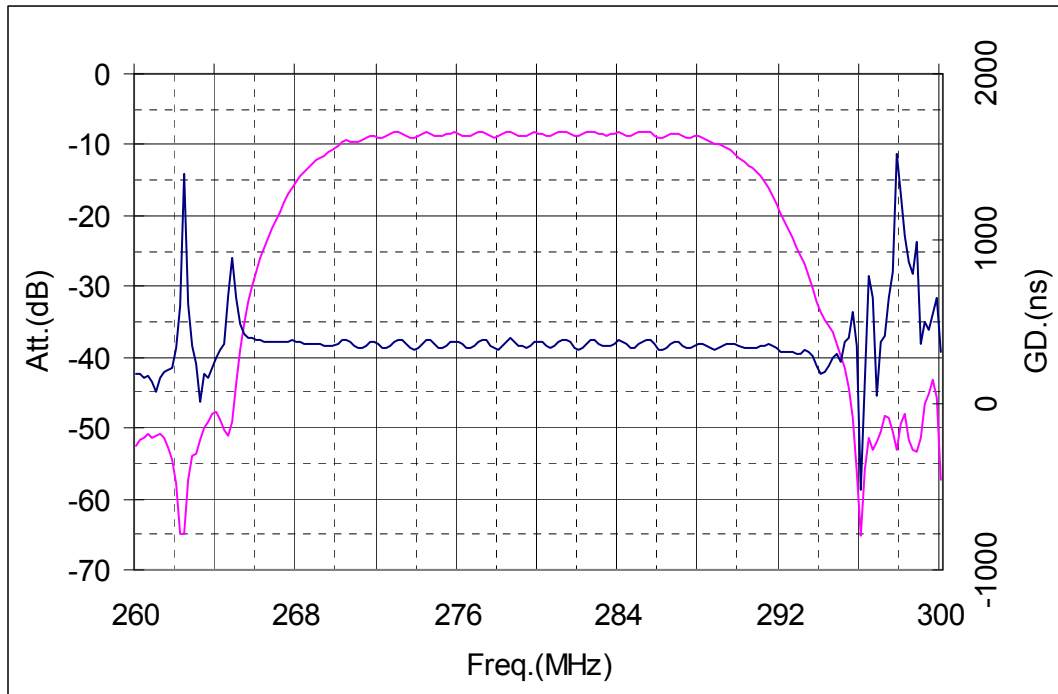

figure 1

### NOTES:

1. Unless noted otherwise, all specifications apply over the operating temperature range with filter soldered to the specified demonstration board with impedance matching to 50  $\Omega$  and measured with 50  $\Omega$  network analyzer.
2. Unless noted otherwise, all frequency specifications are referenced to the nominal center frequency,  $f_C$ .
3. Rejection is measured as attenuation below the minimum IL point in the passband. Rejection in final user application is dependent on PCB layout and external impedance matching design. See Application Note No. 42 for details.
4. The design, manufacturing process, and specifications of this filter are subject to change.
5. Either Port 1 or Port 2 may be used for either input or output in the design. However, impedances and impedance matching may vary between Port 1 and Port 2, so that the filter must always be installed in one direction per the circuit design.
6. US and international patents may apply.
7. Murata, stylized Murata logo, and Murata N.A., Inc. are registered trademarks of Murata Manufacturing Co., Ltd.
8. Electrostatic Sensitive Device. Observe precautions for handling. 

## Frequency Characteristics



# SM5050-8 Case

## 8-Terminal Ceramic Surface-Mount Case 5.0 X 5.0 mm Nominal Footprint

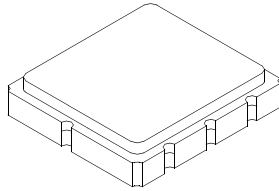

Case Dimensions

Dimension	mm			Inches		
	Min	Nom	Max	Min	Nom	Max
A	4.8	5.0	5.2		0.1968	
B	4.8	5.0	5.2		0.1968	
C			1.7			0.0669
D		2.08			0.0818	
E		1.17			0.046	
F		0.64			0.0252	
G	2.39	2.54	2.69		0.100	

Electrical Connections	Terminals
Input	2
Output	6
Ground	All others
Single Ended Operation	Return is ground
Differential Operation	Return is hot
Dot indicates Pin 1	

TOP VIEW

BOTTOM VIEW

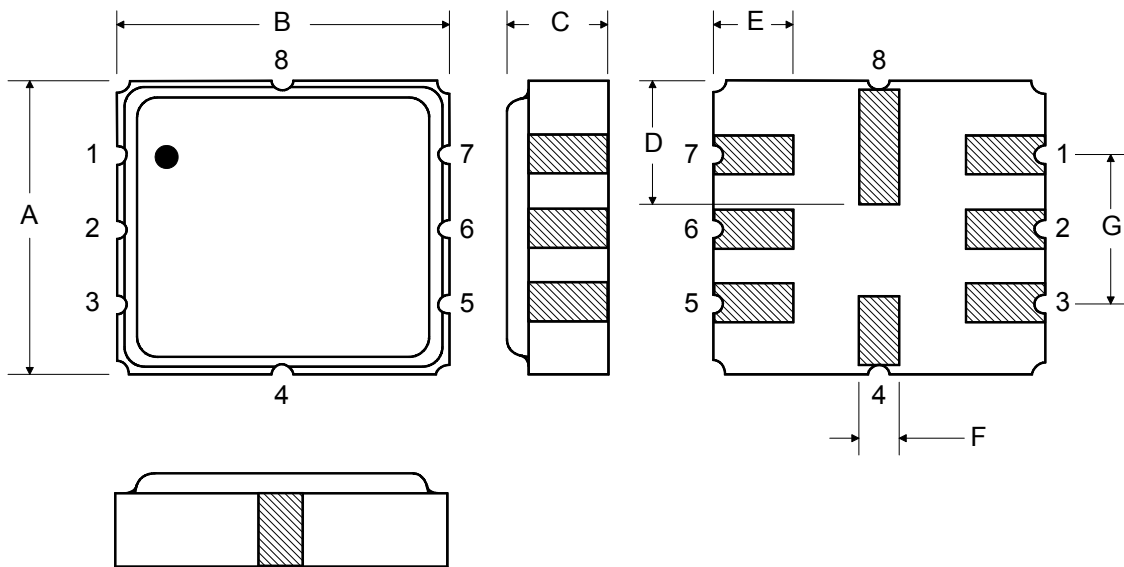

## Tape and Reel Specifications

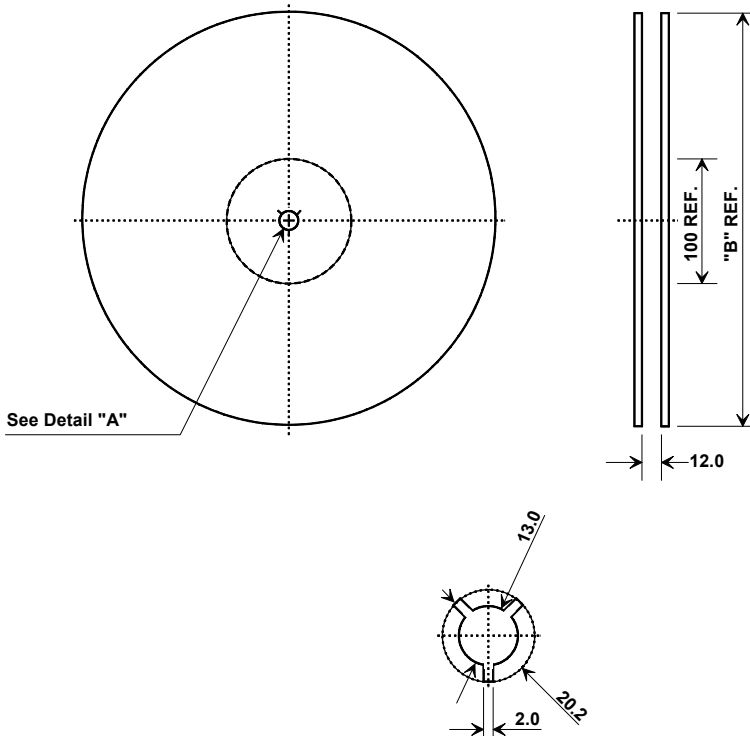

"B" Nominal Size		Quantity Per Reel
Inches	millimeters	
7	178	500
13	330	3000

## COMPONENT ORIENTATION and DIMENSIONS

Carrier Tape Dimensions	
Ao	5.3 mm
Bo	5.3 mm
Ko	2.0 mm
Pitch	8.0 mm
W	12.0 mm

