

μPG2422TK

Data Sheet

GaAs Integrated Circuit
 SPDT Switch for 0.05 GHz to 6.0 GHz

R09DS0013EJ0100
 Rev.1.00
 Jan 20, 2011

DESCRIPTION

The μPG2422TK is a GaAs MMIC SPDT (Single Pole Double Throw) switch which was designed for 0.05 GHz to 6.0 GHz applications, including dual-band wireless LAN.

This device operates with dual control switching voltages of 1.8 to 5.3 V and can operate at frequencies from 0.05 GHz to 6.0 GHz, having the low insertion loss and high isolation.

This device is housed in a 6-pin lead-less minimold package (1511 PKG) and is suitable for high-density surface mounting.

FEATURES

- Switch control voltage : $V_{cont(H)} = 3.0 \text{ V TYP.}$
 : $V_{cont(L)} = 0 \text{ V TYP.}$
- Low insertion loss : $L_{ins} = 0.35 \text{ dB TYP. @ } f = 2.5 \text{ GHz}$
 : $L_{ins} = 0.55 \text{ dB TYP. @ } f = 6.0 \text{ GHz}$
- High isolation : $ISL = 28 \text{ dB TYP. @ } f = 2.5 \text{ GHz}$
 : $ISL = 24 \text{ dB TYP. @ } f = 6.0 \text{ GHz}$
- Handling power : $P_{in(0.1 \text{ dB})} = +28 \text{ dBm TYP. @ } f = 2.0 \text{ to } 6.0 \text{ GHz}$
- High-density surface mounting : 6-pin lead-less minimold package (1.5 × 1.1 × 0.55 mm)

APPLICATIONS

- Wireless LAN (IEEE802.11a/b/g/n), etc.

ORDERING INFORMATION

Part Number	Order Number	Package	Marking	Supplying Form
μPG2422TK-E2	μPG2422TK-E2-A	6-pin lead-less minimold (1511 PKG) (Pb-Free)	G6J	<ul style="list-style-type: none"> • Embossed tape 8 mm wide • Pin 1, 6 face the perforation side of the tape • Qty 5 kpcs/reel

Remark To order evaluation samples, please contact your nearby sales office.

Part number for sample order: μPG2422TK-A

CAUTION

Although this device is designed to be as robust as possible, ESD (Electrostatic Discharge) can damage this device. This device must be protected at all times from ESD. Static charges may easily produce potentials of several kilovolts on the human body or equipment, which can discharge without detection. Industry-standard ESD precautions must be employed at all times.

PIN CONNECTIONS AND INTERNAL BLOCK DIAGRAM

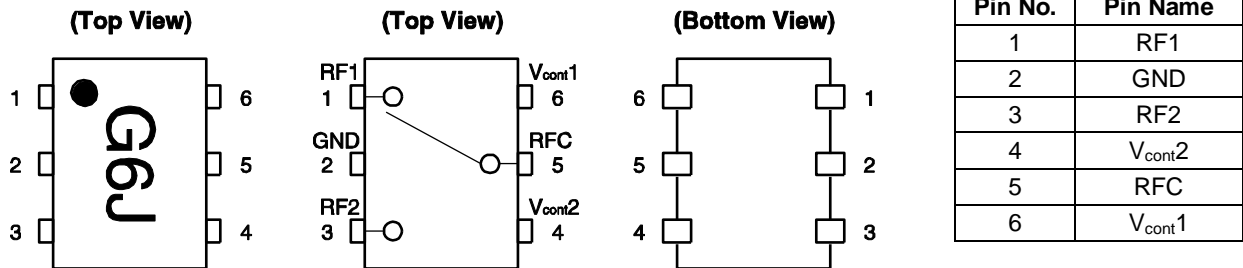

SW TRUTH TABLE

ON Path	V _{cont1}	V _{cont2}
RFC-RF1	High	Low
RFC-RF2	Low	High

ABSOLUTE MAXIMUM RATINGS (T_A = +25°C, unless otherwise specified)

Parameter	Symbol	Ratings	Unit
Switch Control Voltage	V _{cont}	+6.0 ^{Note}	V
Input Power (V _{cont (H)} = 1.8 V)	P _{in}	+29.0	dBm
Input Power (V _{cont (H)} = 3.0 V)	P _{in}	+32.0	dBm
Input Power (V _{cont (H)} = 5.0 V)	P _{in}	+33.0	dBm
Power Dissipation (average)	P _D	150	mW
Operating Ambient Temperature	T _A	-45 to +85	°C
Storage Temperature	T _{stg}	-55 to +150	°C

Note: |V_{cont1} - V_{cont2}| ≤ 6.0 V

RECOMMENDED OPERATING RANGE (T_A = +25°C, unless otherwise specified)

Parameter	Symbol	MIN.	TYP.	MAX.	Unit
Operating Frequency	f	0.05	-	6.0	GHz
Switch Control Voltage (H)	V _{cont (H)}	1.8	3.0	5.3	V
Switch Control Voltage (L)	V _{cont (L)}	-0.2	0	0.2	V
Control Voltage Difference	ΔV _{cont (H)} , ΔV _{cont (L)} Note	-0.1	0	0.1	V

Note: ΔV_{cont (H)} = V_{cont1 (H)} - V_{cont2 (H)}

ΔV_{cont (L)} = V_{cont1 (L)} - V_{cont2 (L)}

ELECTRICAL CHARACTERISTICS 1

($T_A = +25^\circ\text{C}$, $V_{\text{cont (H)}} = 3.0\text{ V}$, $V_{\text{cont (L)}} = 0\text{ V}$, $Z_O = 50\ \Omega$, DC blocking capacitors = 8 pF, unless otherwise specified)

Parameter	Symbol	Test Conditions	MIN.	TYP.	MAX.	Unit
Insertion Loss 1	L_{ins1}	$f = 0.05\text{ to }0.5\text{ GHz}$ ^{Note 1}	–	0.30	–	dB
Insertion Loss 2	L_{ins2}	$f = 0.5\text{ to }2.0\text{ GHz}$ ^{Note 2}	–	0.30	0.50	dB
Insertion Loss 3	L_{ins3}	$f = 2.0\text{ to }2.5\text{ GHz}$	–	0.35	0.55	dB
Insertion Loss 4	L_{ins4}	$f = 2.5\text{ to }3.8\text{ GHz}$	–	0.45	0.65	dB
Insertion Loss 5	L_{ins5}	$f = 3.8\text{ to }6.0\text{ GHz}$	–	0.55	0.75	dB
Isolation 1 (RFC-OFF Port)	ISL1	$f = 0.05\text{ to }0.5\text{ GHz}$ ^{Note 1}	–	35	–	dB
Isolation 2 (RFC-OFF Port)	ISL2	$f = 0.5\text{ to }2.0\text{ GHz}$ ^{Note 2}	25	28	–	dB
Isolation 3 (RFC-OFF Port)	ISL3	$f = 2.0\text{ to }2.5\text{ GHz}$	25	28	–	dB
Isolation 4 (RFC-OFF Port)	ISL4	$f = 2.5\text{ to }3.8\text{ GHz}$	25	28	–	dB
Isolation 5 (RFC-OFF Port)	ISL5	$f = 3.8\text{ to }6.0\text{ GHz}$	20	24	–	dB
Isolation 6 (RF1-RF2)	ISL6	$f = 0.05\text{ to }0.5\text{ GHz}$ ^{Note 1}	–	35	–	dB
Isolation 7 (RF1-RF2)	ISL7	$f = 0.5\text{ to }2.0\text{ GHz}$ ^{Note 2}	25	28	–	dB
Isolation 8 (RF1-RF2)	ISL8	$f = 2.0\text{ to }2.5\text{ GHz}$	25	28	–	dB
Isolation 9 (RF1-RF2)	ISL9	$f = 2.5\text{ to }3.8\text{ GHz}$	25	28	–	dB
Isolation 10 (RF1-RF2)	ISL10	$f = 3.8\text{ to }6.0\text{ GHz}$	25	28	–	dB
Return Loss 1	RL1	$f = 0.05\text{ to }0.5\text{ GHz}$ ^{Note 1}	–	25	–	dB
Return Loss 2	RL2	$f = 0.5\text{ to }2.0\text{ GHz}$ ^{Note 2}	15	20	–	dB
Return Loss 3	RL3	$f = 2.0\text{ to }2.5\text{ GHz}$	15	20	–	dB
Return Loss 4	RL4	$f = 2.5\text{ to }6.0\text{ GHz}$	10	15	–	dB
0.1 dB Loss Compression Input Power ^{Note 3}	$P_{\text{in (0.1 dB)}}$	$f = 0.05\text{ to }0.5\text{ GHz}$ ^{Note 1}	–	28	–	dBm
		$f = 0.5\text{ to }2.0\text{ GHz}$ ^{Note 2}	–	29	–	dBm
		$f = 2.0\text{ to }6.0\text{ GHz}$	–	28	–	dBm
		$f = 0.05\text{ to }0.5\text{ GHz}$ ^{Note 1} , $V_{\text{cont (H)}} = 5.0\text{ V}$	–	32	–	dBm
		$f = 0.5\text{ to }2.0\text{ GHz}$ ^{Note 2} , $V_{\text{cont (H)}} = 5.0\text{ V}$	–	32	–	dBm
		$f = 2.0\text{ to }6.0\text{ GHz}$, $V_{\text{cont (H)}} = 5.0\text{ V}$	–	32	–	dBm
1 dB Loss Compression Input Power ^{Note 4}	$P_{\text{in (1 dB)}}$	$f = 0.05\text{ to }0.5\text{ GHz}$ ^{Note 1}	–	32	–	dBm
		$f = 0.5\text{ to }2.0\text{ GHz}$ ^{Note 2}	–	32	–	dBm
		$f = 2.0\text{ to }6.0\text{ GHz}$	–	31	–	dBm
Input 3rd Order Intercept Point	IIP ₃	$f = 2.5\text{ GHz}$, $P_{\text{in}} = +20\text{ dBm}$	–	57	–	dBm
2nd Harmonics	2f ₀	$f = 2.5\text{ GHz}$, $P_{\text{in}} = +20\text{ dBm}$	–	80	–	dBc
3rd Harmonics	3f ₀	$f = 2.5\text{ GHz}$, $P_{\text{in}} = +20\text{ dBm}$	–	80	–	dBc
Switch Control Current	I_{cont}	No RF input	–	0.1	5	μA
Switch Control Speed	t_{sw}	50% CTL to 90/10% RF	–	40	100	ns

Notes 1. DC blocking capacitors = 1 000 pF at $f = 0.05\text{ to }0.5\text{ GHz}$

2. DC blocking capacitors = 56 pF at $f = 0.5\text{ to }2.0\text{ GHz}$

3. $P_{\text{in (0.1 dB)}}$ is the measured input power level when the insertion loss increases 0.1 dB more than that of the linear range.

4. $P_{\text{in (1 dB)}}$ is the measured input power level when the insertion loss increases 1 dB more than that of the linear range.

CAUTION

It is necessary to use DC blocking capacitors with this device.

The value of DC blocking capacitors should be chosen to accommodate the frequency of operation, bandwidth, switching speed and the condition with actual board of your system.

ELECTRICAL CHARACTERISTICS 2

($T_A = +25^\circ\text{C}$, $V_{\text{cont (H)}} = 1.8\text{ V}$, $V_{\text{cont (L)}} = 0\text{ V}$, $Z_O = 50\ \Omega$, DC blocking capacitors = 8 pF, unless otherwise specified)

Parameter	Symbol	Test Conditions	MIN.	TYP.	MAX.	Unit
Insertion Loss 1	$L_{\text{ins}1}$	$f = 0.05\text{ to }0.5\text{ GHz}$ ^{Note 1}	–	0.30	–	dB
Insertion Loss 2	$L_{\text{ins}2}$	$f = 0.5\text{ to }2.0\text{ GHz}$ ^{Note 2}	–	0.30	0.55	dB
Insertion Loss 3	$L_{\text{ins}3}$	$f = 2.0\text{ to }2.5\text{ GHz}$	–	0.35	0.60	dB
Insertion Loss 4	$L_{\text{ins}4}$	$f = 2.5\text{ to }3.8\text{ GHz}$	–	0.45	0.70	dB
Insertion Loss 5	$L_{\text{ins}5}$	$f = 3.8\text{ to }6.0\text{ GHz}$	–	0.55	0.80	dB
Isolation 1 (RFC-OFF Port)	ISL1	$f = 0.05\text{ to }0.5\text{ GHz}$ ^{Note 1}	–	35	–	dB
Isolation 2 (RFC-OFF Port)	ISL2	$f = 0.5\text{ to }2.0\text{ GHz}$ ^{Note 2}	24	28	–	dB
Isolation 3 (RFC-OFF Port)	ISL3	$f = 2.0\text{ to }2.5\text{ GHz}$	24	28	–	dB
Isolation 4 (RFC-OFF Port)	ISL4	$f = 2.5\text{ to }3.8\text{ GHz}$	24	28	–	dB
Isolation 5 (RFC-OFF Port)	ISL5	$f = 3.8\text{ to }6.0\text{ GHz}$	19	24	–	dB
Isolation 6 (RF1-RF2)	ISL6	$f = 0.05\text{ to }0.5\text{ GHz}$ ^{Note 1}	–	35	–	dB
Isolation 7 (RF1-RF2)	ISL7	$f = 0.5\text{ to }2.0\text{ GHz}$ ^{Note 2}	24	28	–	dB
Isolation 8 (RF1-RF2)	ISL8	$f = 2.0\text{ to }2.5\text{ GHz}$	24	28	–	dB
Isolation 9 (RF1-RF2)	ISL9	$f = 2.5\text{ to }3.8\text{ GHz}$	24	28	–	dB
Isolation 10 (RF1-RF2)	ISL10	$f = 3.8\text{ to }6.0\text{ GHz}$	24	28	–	dB
Return Loss 1	RL1	$f = 0.05\text{ to }0.5\text{ GHz}$ ^{Note 1}	–	25	–	dB
Return Loss 2	RL2	$f = 0.5\text{ to }2.0\text{ GHz}$ ^{Note 2}	15	20	–	dB
Return Loss 3	RL3	$f = 2.0\text{ to }2.5\text{ GHz}$	15	20	–	dB
Return Loss 4	RL4	$f = 2.5\text{ to }6.0\text{ GHz}$	10	15	–	dB
0.1 dB Loss Compression Input Power ^{Note 3}	$P_{\text{in (0.1 dB)}}$	$f = 0.05\text{ to }0.5\text{ GHz}$ ^{Note 1}	–	22	–	dBm
		$f = 0.5\text{ to }2.0\text{ GHz}$ ^{Note 2}	–	22	–	dBm
		$f = 2.0\text{ to }6.0\text{ GHz}$	–	21	–	dBm
1 dB Loss Compression Input Power ^{Note 4}	$P_{\text{in (1 dB)}}$	$f = 0.05\text{ to }0.5\text{ GHz}$ ^{Note 1}	–	28	–	dBm
		$f = 0.5\text{ to }2.0\text{ GHz}$ ^{Note 2}	–	27	–	dBm
		$f = 2.0\text{ to }6.0\text{ GHz}$	–	24	–	dBm
2nd Harmonics	2f ₀	$f = 2.5\text{ GHz}$, $P_{\text{in}} = +15\text{ dBm}$	–	80	–	dBc
3rd Harmonics	3f ₀	$f = 2.5\text{ GHz}$, $P_{\text{in}} = +15\text{ dBm}$	–	80	–	dBc
Switch Control Current	I_{cont}	No RF input	–	0.1	5	μA
Switch Control Speed	t_{sw}	50% CTL to 90/10% RF	–	60	150	ns

Notes 1. DC blocking capacitors = 1 000 pF at $f = 0.05\text{ to }0.5\text{ GHz}$

2. DC blocking capacitors = 56 pF at $f = 0.5\text{ to }2.0\text{ GHz}$

3. $P_{\text{in (0.1 dB)}}$ is the measured input power level when the insertion loss increases 0.1 dB more than that of the linear range.

4. $P_{\text{in (1 dB)}}$ is the measured input power level when the insertion loss increases 1 dB more than that of the linear range.

CAUTION

It is necessary to use DC blocking capacitors with this device.

The value of DC blocking capacitors should be chosen to accommodate the frequency of operation, bandwidth, switching speed and the condition with actual board of your system.

EVALUATION CIRCUIT

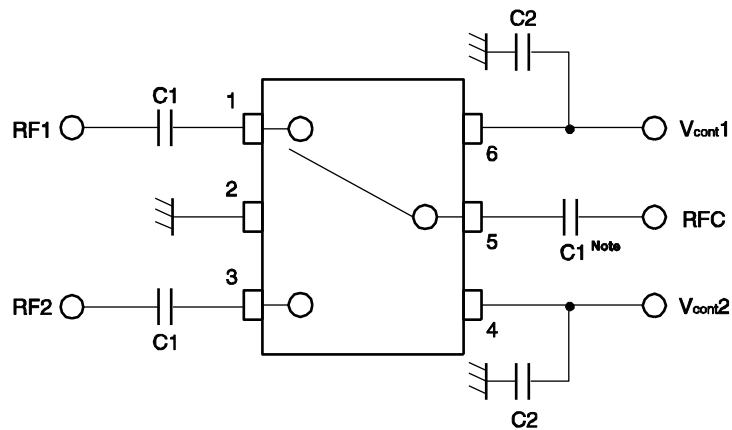

Note C1 : 0.05 to 0.5 GHz 1 000 pF
 : 0.5 to 2.0 GHz 56 pF
 : 2.0 to 6.0 GHz 8 pF
 C2 : 1 000 pF

The application circuits and their parameters are for reference only and are not intended for use in actual design-ins.

APPLICATION INFORMATION

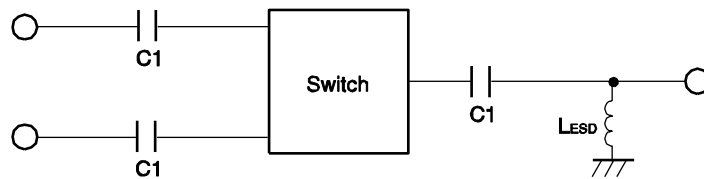

- C1 are DC blocking capacitors external to the device.
The value may be tailored to provide specific electrical responses.
- The RF ground connections should be kept as short as possible and connected to directly to a good RF ground for best performance.
- L_{ESD} provides a means to increase the ESD protection on a specific RF port, typically the port attached to the antenna.

TYPICAL CHARACTERISTICS

($T_A = +25^\circ\text{C}$, $V_{\text{cont (H)}} = 3.0\text{ V}$, $V_{\text{cont (L)}} = 0\text{ V}$, $Z_O = 50\ \Omega$, DC blocking capacitors = 8 pF, unless otherwise specified)

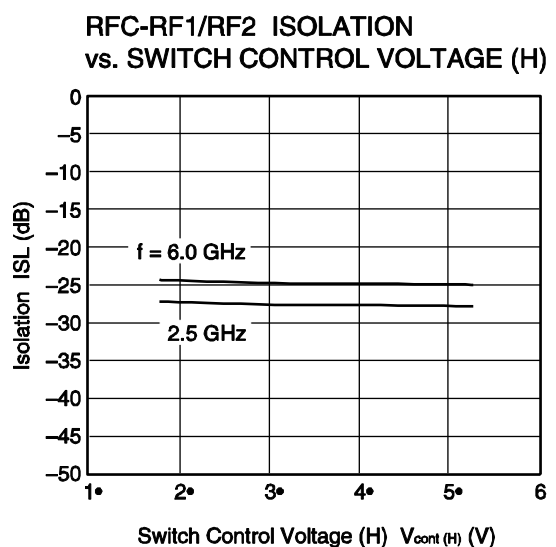
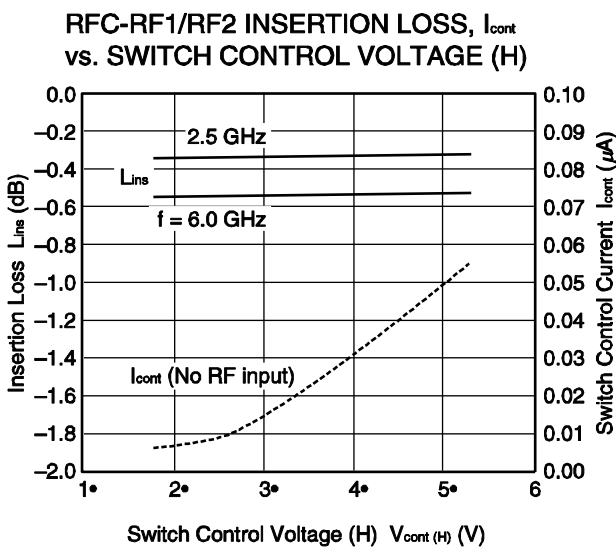
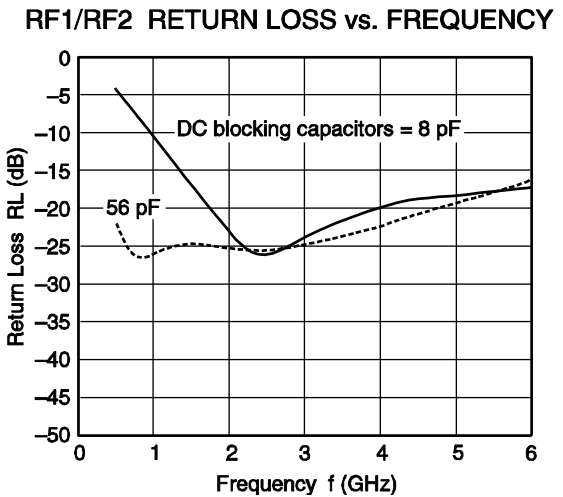
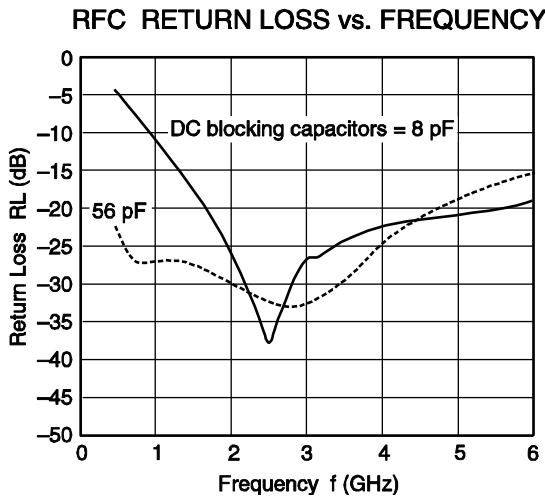
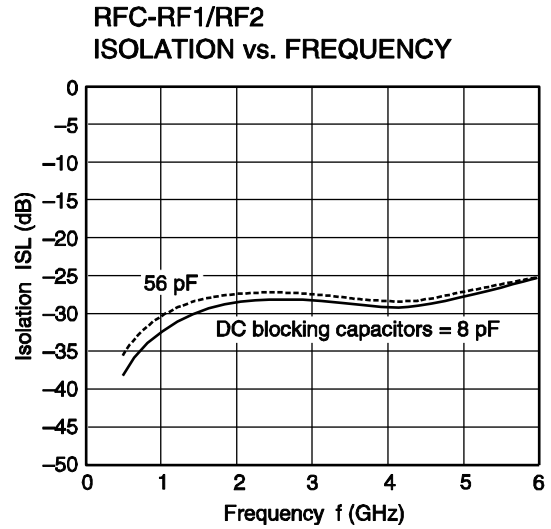
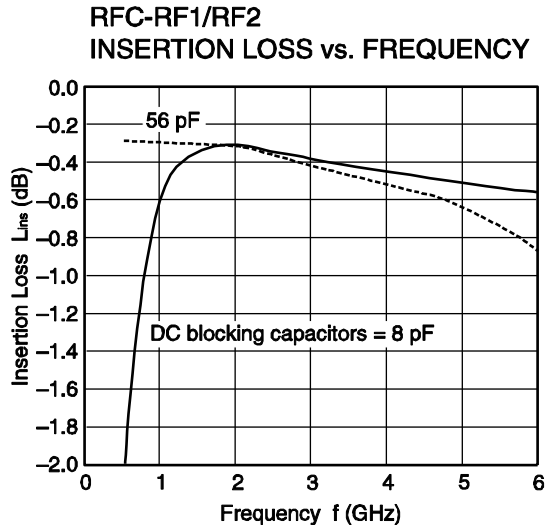

Remark The graphs indicate nominal characteristics.

RFC RETURN LOSS vs. SWITCH CONTROL VOLTAGE (H)

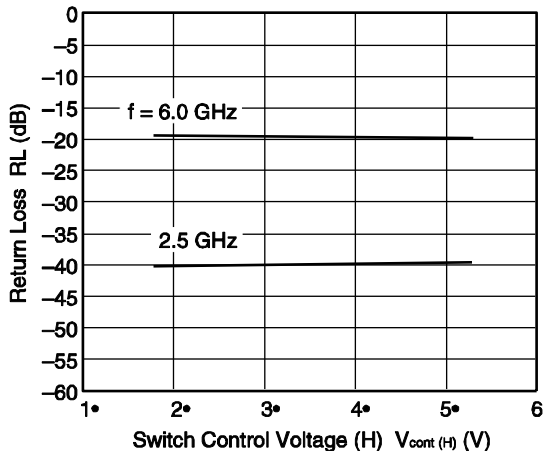

RF1/RF2 RETURN LOSS vs. SWITCH CONTROL VOLTAGE (H)

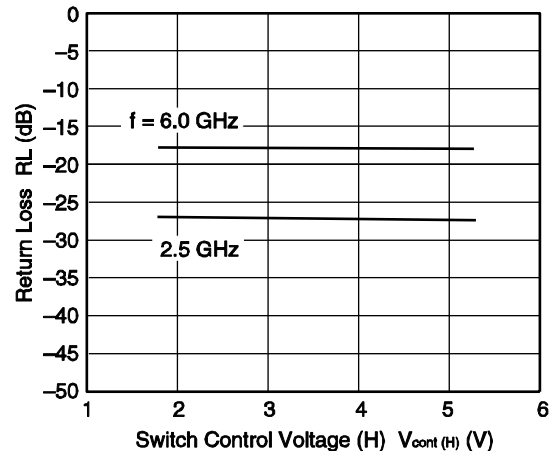

RFC-RF1/RF2 INSERTION LOSS, Icont vs. INPUT POWER

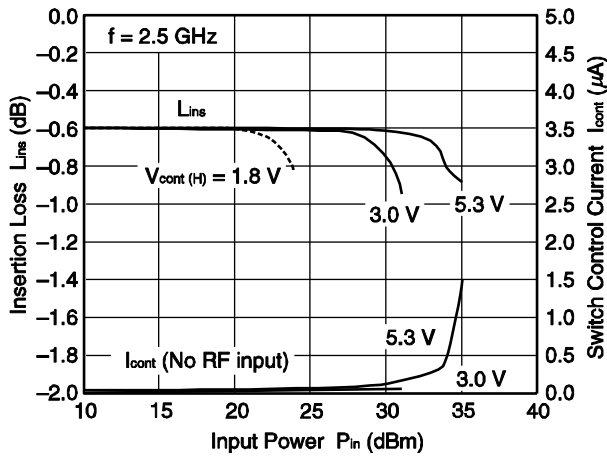

RFC-RF1/RF2 Pin (0.1 dB) vs. INPUT POWER

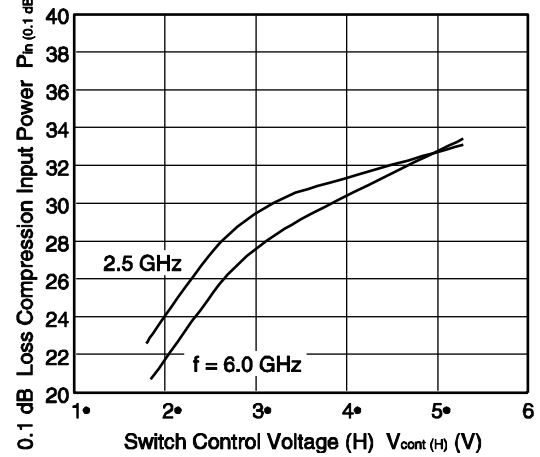

RFC-RF1/RF2 2f0, 3f0 vs. INPUT POWER

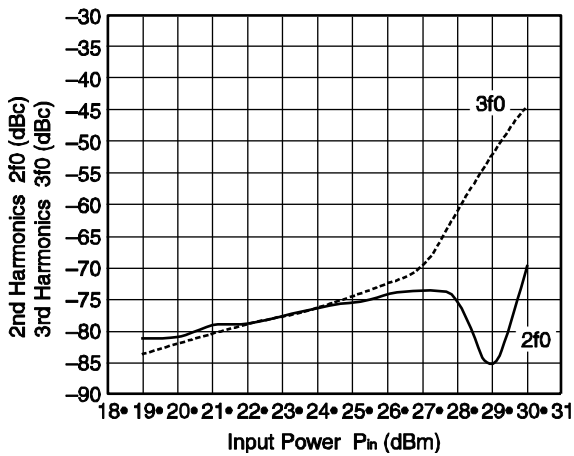

RFC-RF1/RF2 OUTPUT POWER, IM3 vs. INPUT POWER

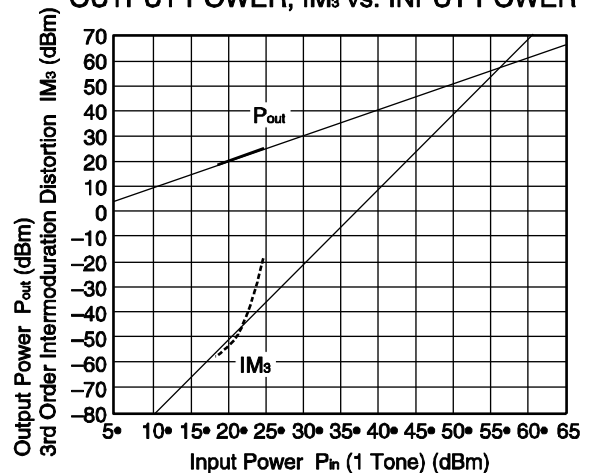

Remark The graphs indicate nominal characteristics.

TYPICAL CHARACTERISTICS

($T_A = -45$ to $+85^\circ\text{C}$, $V_{\text{cont (H)}} = 3.0\text{ V}$, $V_{\text{cont (L)}} = 0\text{ V}$, $Z_O = 50\ \Omega$, DC blocking capacitors = 8 pF, unless otherwise specified)

RFC-RF1/RF2 INSERTION LOSS vs. OPERATING AMBIENT TEMPERATURE

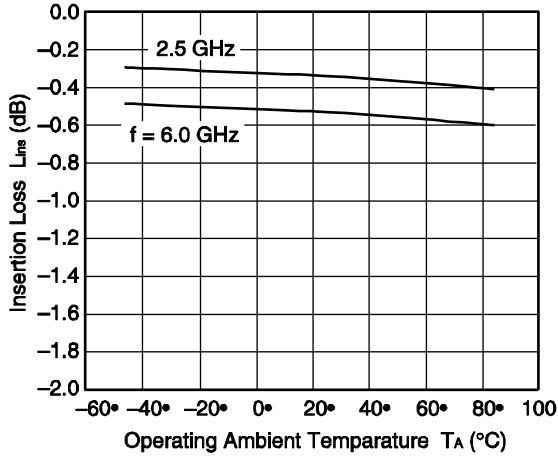

RFC-RF1/RF2 ISOLATION vs. OPERATING AMBIENT TEMPERATURE

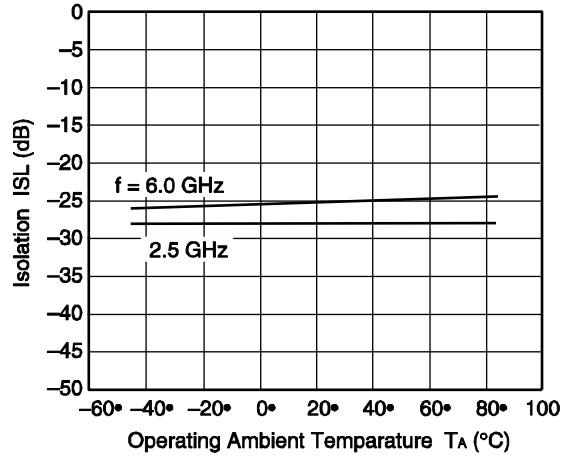

RFC RETURN LOSS vs. OPERATING AMBIENT TEMPERATURE

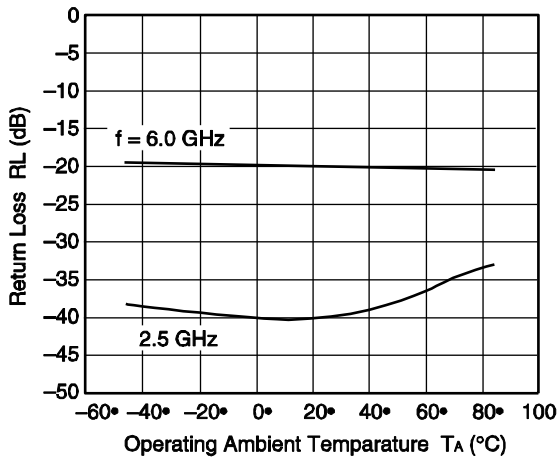

RF1/RF2 RETURN LOSS vs. OPERATING AMBIENT TEMPERATURE

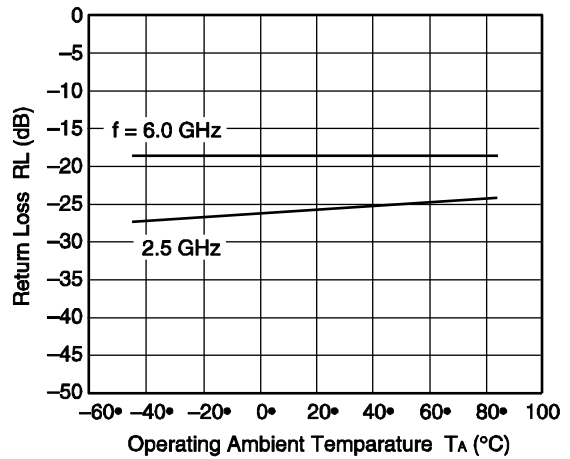

RFC-RF1/RF2 P_{in} (0.1 dB) vs. OPERATING AMBIENT TEMPERATURE

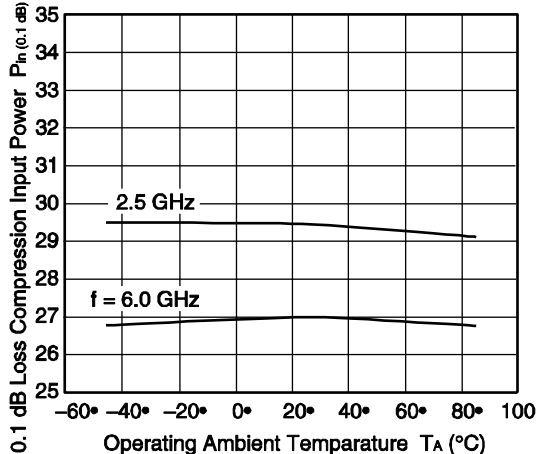

Remark The graphs indicate nominal characteristics.

RFC-RF1/RF2
 INSERTION LOSS vs. FREQUENCY

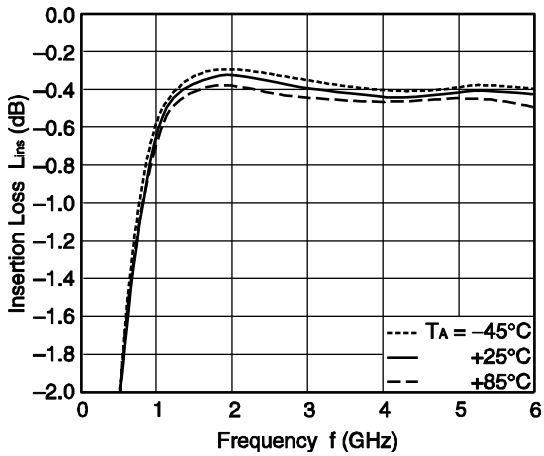

RFC-RF1/RF2
 ISOLATION vs. FREQUENCY

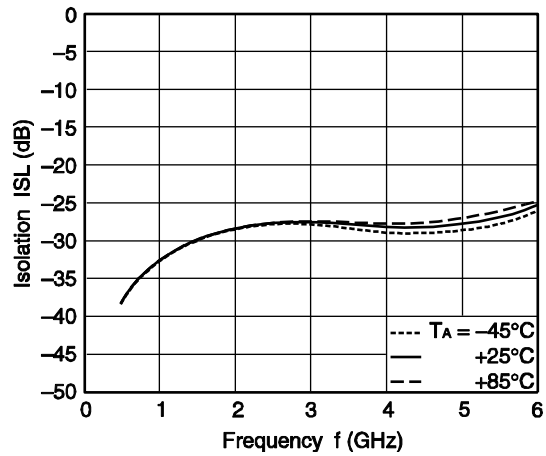

RFC RETURN LOSS vs. FREQUENCY

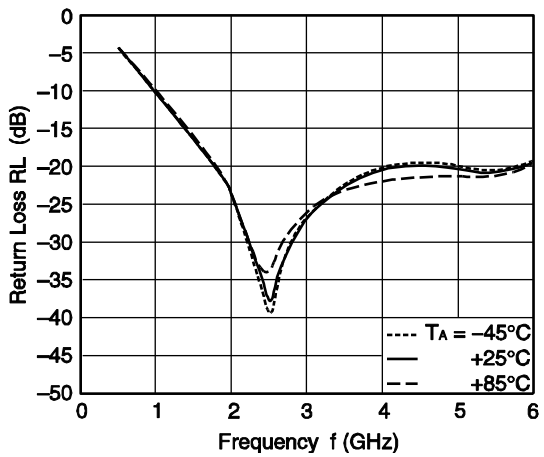

RF1/RF2 RETURN LOSS vs. FREQUENCY

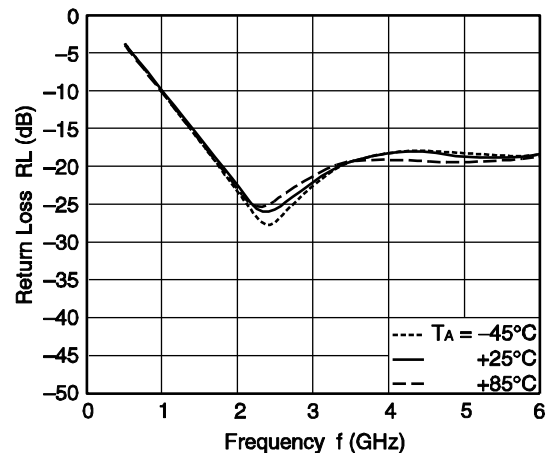

Remark The graphs indicate nominal characteristics.

TYPICAL CHARACTERISTICS

($V_{cont(H)} = 3.0\text{ V}$, $V_{cont(L)} = 0\text{ V}$, $Z_O = 50\ \Omega$, DC blocking capacitors = 56 pF, unless otherwise specified)

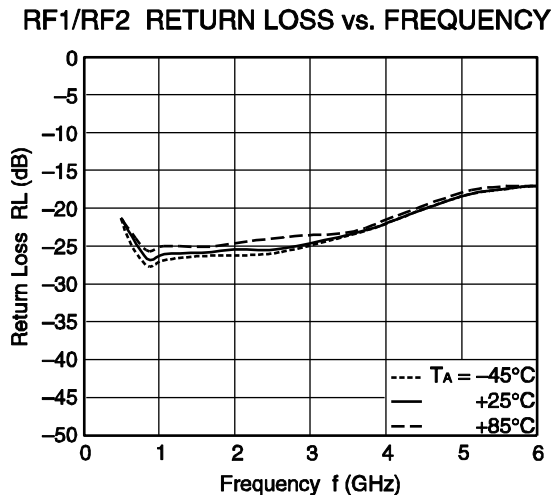
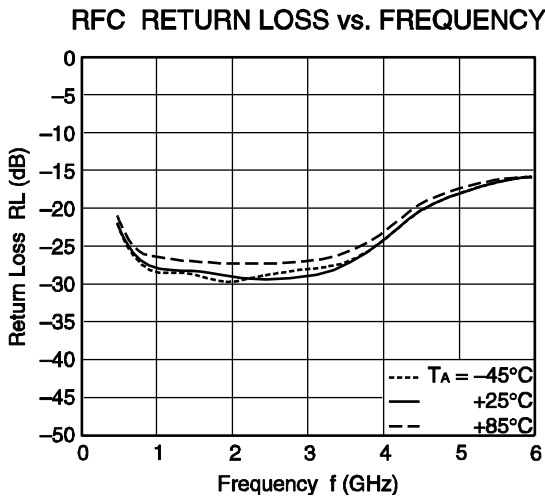
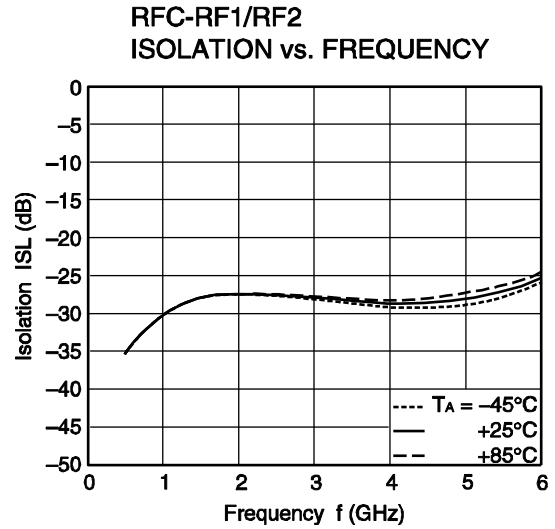
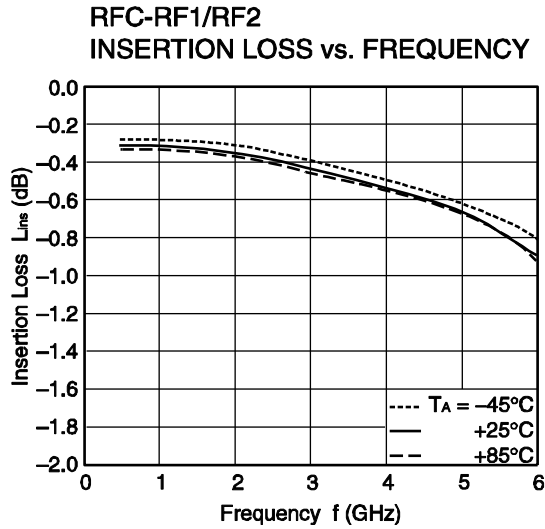

Remark The graphs indicate nominal characteristics.

TYPICAL CHARACTERISTICS

($V_{cont(H)} = 3.0\text{ V}$, $V_{cont(L)} = 0\text{ V}$, $Z_O = 50\ \Omega$, DC blocking capacitors = 1 000 pF, unless otherwise specified)

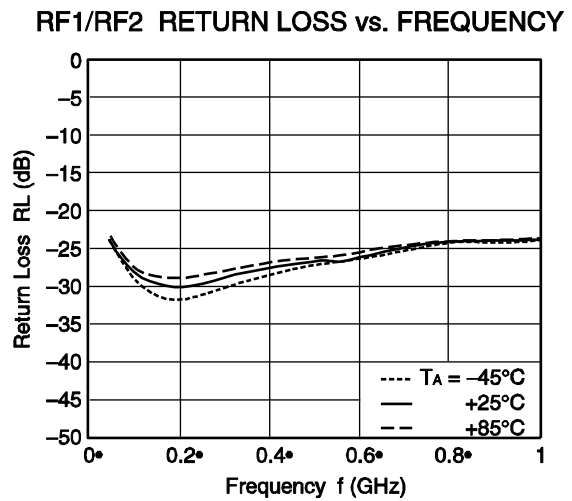
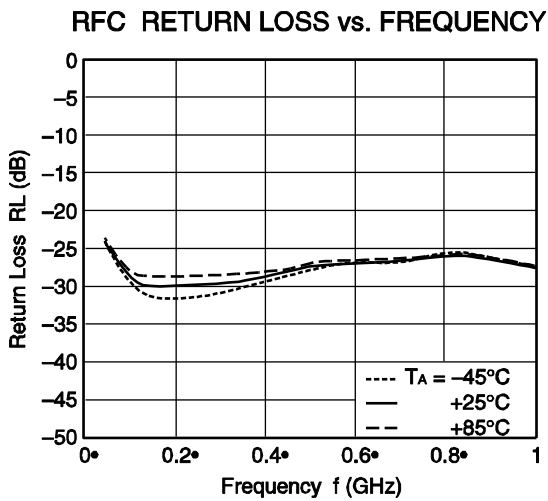
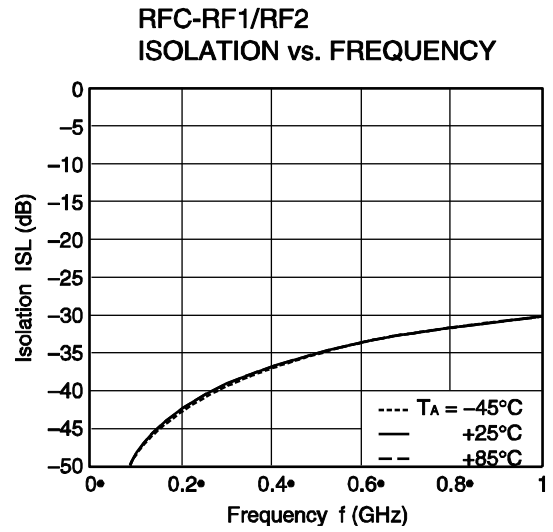
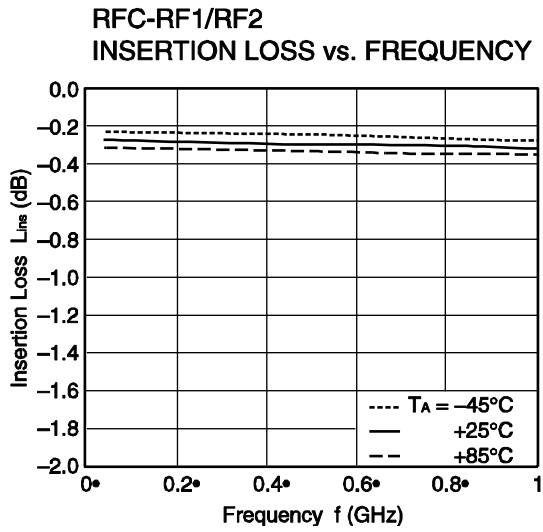

Remark The graphs indicate nominal characteristics.

MOUNTING PAD LAYOUT DIMENSIONS

6-PIN LEAD-LESS MINIMOLD (1511 PKG) (UNIT: mm)

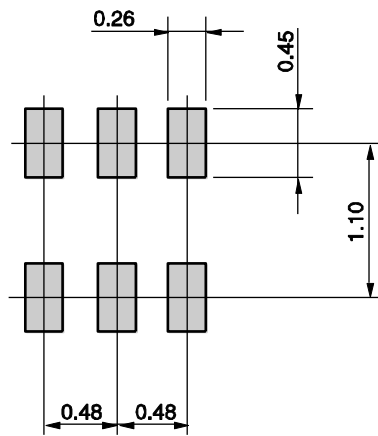

Remark The mounting pad layout in this document is for reference only.

PACKAGE DIMENSIONS

6-PIN LEAD-LESS MINIMOLD (1511 PKG) (UNIT: mm)

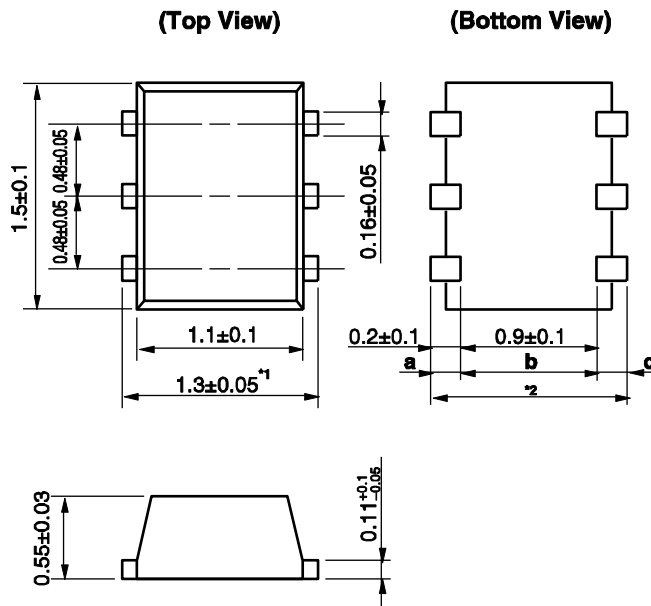

Remark Dimension¹ is bigger than dimension² (dimension² = a + b + c).

RECOMMENDED SOLDERING CONDITIONS

This product should be soldered and mounted under the following recommended conditions. For soldering methods and conditions other than those recommended below, contact your nearby sales office.

Soldering Method	Soldering Conditions	Condition Symbol
Infrared Reflow	Peak temperature (package surface temperature) : 260°C or below Time at peak temperature : 10 seconds or less Time at temperature of 220°C or higher : 60 seconds or less Preheating time at 120 to 180°C : 120±30 seconds Maximum number of reflow processes : 3 times Maximum chlorine content of rosin flux (% mass) : 0.2%(Wt.) or below	IR260
Wave Soldering	Peak temperature (molten solder temperature) : 260°C or below Time at peak temperature : 10 seconds or less Preheating temperature (package surface temperature): 120°C or below Maximum number of flow processes : 1 time Maximum chlorine content of rosin flux (% mass) : 0.2%(Wt.) or below	WS260
Partial Heating	Peak temperature (terminal temperature) : 350°C or below Soldering time (per side of device) : 3 seconds or less Maximum chlorine content of rosin flux (% mass) : 0.2%(Wt.) or below	HS350

CAUTION

Do not use different soldering methods together (except for partial heating).

Caution	GaAs Products	<p>This product uses gallium arsenide (GaAs). GaAs vapor and powder are hazardous to human health if inhaled or ingested, so please observe the following points.</p> <ul style="list-style-type: none">• Follow related laws and ordinances when disposing of the product. If there are no applicable laws and/or ordinances, dispose of the product as recommended below.<ol style="list-style-type: none">1. Commission a disposal company able to (with a license to) collect, transport and dispose of materials that contain arsenic and other such industrial waste materials.2. Exclude the product from general industrial waste and household garbage, and ensure that the product is controlled (as industrial waste subject to special control) up until final disposal.• Do not burn, destroy, cut, crush, or chemically dissolve the product.• Do not lick the product or in any way allow it to enter the mouth.
----------------	---------------	--

Revision History	μPG2422TK Data Sheet
-------------------------	-----------------------------

Rev.	Date	Description	
		Page	Summary
1.00	Jan 20, 2011	–	First edition issued

All trademarks and registered trademarks are the property of their respective owners.