

Four-Channel Multiplexed Transimpedance Amplifier with Output Multiplexing

FEATURES

- 220MHz –3dB Bandwidth with 2pF Input Capacitance
- Single-Ended Output
- 74kΩ Transimpedance Gain
- 4.5pA/√Hz Input Current Noise Density at 200MHz (2pF)
- 56nA_{RMS} Integrated Input Current Noise Over 200MHz (2pF)
- Linear Input Range 0μA to 30μA
- Overload Current > ±400mA Peak
- Fast Overload Recovery 12ns, 1mA
- Fast Channel Switchover < 50ns
- Single 5V Supply
- 220mW Power Dissipation for 4 Channels
- 2V_{P-P} Output Swing on 100Ω Load
- 4mm × 4mm, 24-Lead QFN Package
- Output MUX Combines Multiple 4-Channel Devices to Create 4, 8, 12, 16, 24, 32 Channel Solutions

APPLICATIONS

- LIDAR Receiver
- Industrial Imaging

All registered trademarks and trademarks are the property of their respective owners.

DESCRIPTION

The LTC6561 is a low-noise, four-channel, transimpedance amplifier (TIA) with 220MHz bandwidth. The LTC6561 multi-channel transimpedance amplifier's low noise, high transimpedance, and low power dissipation are ideal for LIDAR receivers using Avalanche Photodiodes (APDs). The amplifier features 74kΩ transimpedance gain and 30μA linear input current range. Using an APD input circuit with a total capacitance of 2pF, the input current noise density is 4.5pA/√Hz at 200MHz. With lower capacitance, noise and bandwidth improve further. Only a 5V single supply is needed and the device consumes only 220mW. Utilizing the internal 4-to-1 MUX along with the LTC6561's output MUX; multiple 4-channel LTC6561 devices can be combined to directly interface with 12-, 16- and 32-channel APD arrays. The LTC6561's fast overload recovery and fast channel switchover make it well suited for LIDAR receivers with multiple APDs. Its single-ended output can swing 2V_{P-P} on a 100Ω load while its low impedance opamp-style output can drive back-terminated 50Ω cables.

The LTC6561 is packaged in a compact 4mm × 4mm 24-pin leadless QFN package with an exposed pad for thermal management and low inductance.

TYPICAL APPLICATION

Typical Application with DC-Coupled Inputs Driving a Time-to-Digital Converter with Back-Terminated Cable

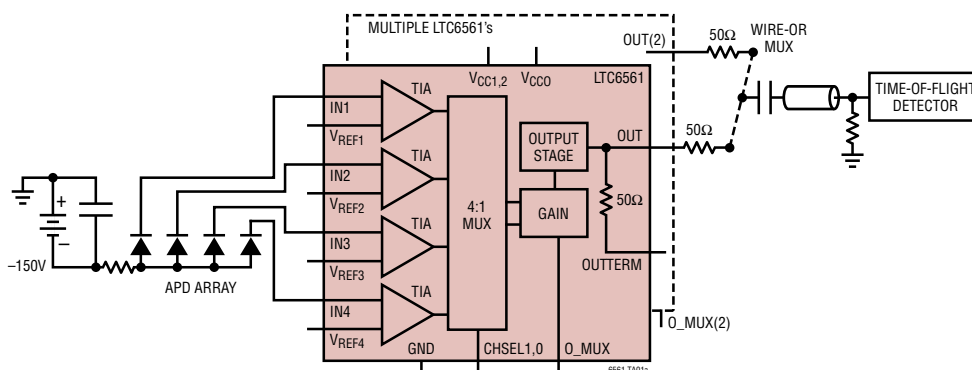

Pulse Response Overload Region (40μA)

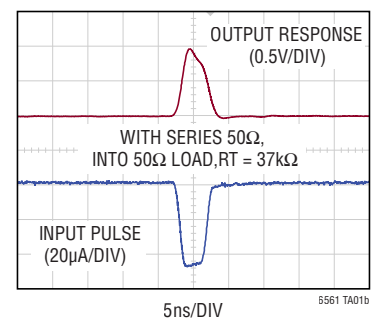

ABSOLUTE MAXIMUM RATINGS

(Note 1)

Total Supply Voltage (V_{CC1} , V_{CC2} , V_{CC0} to GND).....	5.5V
Input Current (CHSELO, CHSEL1, O_MUX).....	-10mA
Amplifier Reference Current (V_{REF1} , V_{REF2} , V_{REF3} , V_{REF4})	± 10 mA
Amplifier Input Current (IN1, IN2, IN3, IN4)	± 400 mA RMS ± 2 A Transient (10ns)
Amplifier Output Current (OUT, OUTTERM)	+80mA
Operating Temperature Range	
LTC6561I (Note 2).....	-40°C to 85°C
Storage Temperature Range	-65°C to 150°C
Junction Temperature	150°C

PIN CONFIGURATION

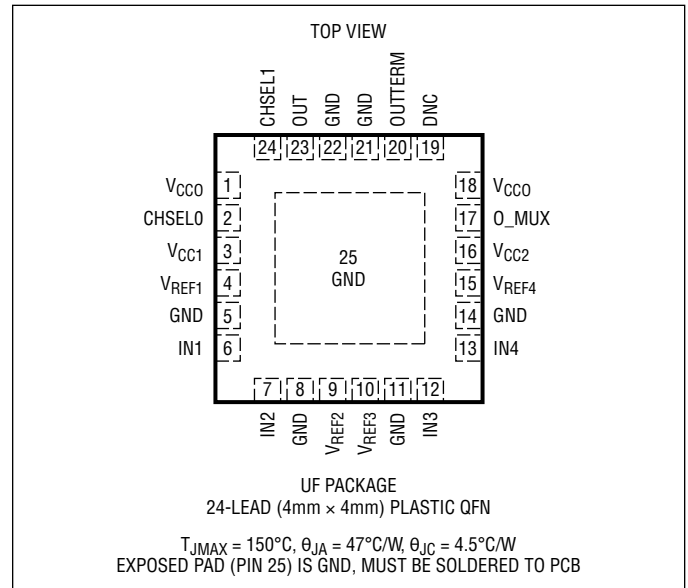

ORDER INFORMATION

TUBE	TAPE AND REEL	PART MARKING*	PACKAGE DESCRIPTION	TEMPERATURE RANGE
LTC6561IUF#PBF	LTC6561IUF#TRPBF	6561	24-LEAD (4mm x 4mm) PLASTIC QFN	-40°C to 85°C

Consult ADI Marketing for parts specified with wider operating temperature ranges. *The temperature grade is identified by a label on the shipping container.

[Tape and reel specifications](#). Some packages are available in 500 unit reels through designated sales channels with #TRMPBF suffix.

AC ELECTRICAL CHARACTERISTICS The ● denotes the specifications which apply over the full operating temperature range, otherwise specifications are at $T_A = 25^{\circ}\text{C}$, $V_{CC1,2} = V_{CC0} = 5\text{V}$, $O_MUX = 0\text{V}$, $GND = 0\text{V}$, $Z_{LOAD} = 100\Omega$. Output is AC-coupled. Output taken from OUT pin.

SYMBOL	PARAMETER	CONDITIONS	MIN	TYP	MAX	UNITS
BW	-3dB Bandwidth	200mV _{P-P,OUT} and $C_{IN,TOT} = 2\text{pF}$		220		MHz
R_T	Small Signal Transimpedance	$I_{IN} < 2\mu\text{A}_{P-P}$	63 47.7	74	85 93	k Ω
R_{IN}	Input Resistance	$f = 100\text{kHz}$		236		Ω
R_{OUT}	Output Resistance	$f = 100\text{kHz}$		3		Ω
I_n	Input Current Noise Density	$f = 100\text{MHz}$, $C_{IN,TOT} = 2\text{pF}$		3.8		pA/ $\sqrt{\text{Hz}}$
		$f = 200\text{MHz}$, $C_{IN,TOT} = 2\text{pF}$		4.5		pA/ $\sqrt{\text{Hz}}$
	Integrated Input Current Noise	$f = 0.1\text{MHz}$ to 100MHz, $C_{IN,TOT} = 2\text{pF}$		39		nA _{RMS}
		$f = 0.1\text{MHz}$ to 200MHz, $C_{IN,TOT} = 2\text{pF}$		56		nA _{RMS}
	Adjacent Channel to Channel Isolation	$f = 100\text{MHz}$		-45		dB
	Non Adjacent Channel Isolation	$f = 100\text{MHz}$		-65		dB
$t_{RECOVER}$	Overload Recovery Time	Input pulse <1mA		15		ns
t_{SWITCH}	Channel Switchover Time			50		ns

DC ELECTRICAL CHARACTERISTICS The ● denotes the specifications which apply over the full operating temperature range, otherwise specifications are at $T_A = 25^\circ\text{C}$, $V_{CC1,2} = V_{CC0} = 5\text{V}$, $O_MUX = 0\text{V}$, $\text{GND} = 0\text{V}$, $Z_{\text{LOAD}} = 100\Omega$. Output is AC-coupled. Output taken from OUT pin.

SYMBOL	PARAMETER	CONDITIONS	MIN	TYP	MAX	UNITS	
IN1,2,3,4 Pins and $V_{\text{REF}1,2,3,4}$ Pins							
V_{IN}	Input Bias Voltage	Active Channel	●	1.42	1.55	1.64	V
				1.32		1.74	V
		Inactive Channel	●	0.89	0.93	0.96	V
				0.79		1.06	V
V_{REF}	Input Reference Voltage	Active Channel		1.43	1.55	1.63	V
		Inactive Channel		1.34	1.50	1.67	V
Offset	$V_{\text{IN}} - V_{\text{REF}}$	Active Channel		-12		13.8	mV
		Inactive Channel		-727		-420	mV
OUT Pin							
V_{OUT}	Output Default Voltage	$O_MUX = 0\text{V}$	●	0.83	1.10	1.45	V
				0.79		1.67	V
		$O_MUX = 3.3\text{V}$, Standalone Device	●	0.32	0.60	0.88	V
				0.28		0.92	V
OVR	Output Voltage Range	I_{IN} Current Range= 0 to $-50\mu\text{A}$	●	1.22	1.90	2.58	$V_{\text{P-P}}$
				0.98		2.80	$V_{\text{P-P}}$
OUTTERM	Internal Series Resistor for Optional Output			48.6	50	70.8	Ω
CHSEL0, CHSEL1, O_MUX Pins with Internal Pull-Down Resistors							
V_{IL}					0.8	V	
V_{IH}				1.5		V	
I_{IL}	Pin Voltage = 0.8V	●		16.9	20.7	26.0	μA
				15.4		28.0	μA
I_{IH}	Pin Voltage = 1.5V	●		39.3	34.6	50.0	μA
				38.0		55.0	μA
C_{IN}				1.5		pF	
R_{IN}		●		25	29	32	$\text{k}\Omega$
				23		34	$\text{k}\Omega$
Power Supply							
V_{S}	Operating Supply Range			4.75	5	5.25	V
$I_{\text{CC}1,2}$	Input Supply Current	$V_{\text{CC}1}$ & $V_{\text{CC}2}$ are Internally Tied Together	●	38.0	43	49.0	mA
				37.0		50.0	mA
$I_{\text{CC}0}$	Output Supply Current	Both $V_{\text{CC}0}$ pins are Internally Tied Together	●	2.1	2.6	2.8	mA
				2.0		2.9	mA
I_{S}	Total Supply Current ($I_{\text{S}}(V_{\text{CC}1,2}) + I_{\text{S}}(V_{\text{CC}0})$)	●		40.1	45.6	51.8	mA
				39.0		52.9	mA
PSRR($V_{\text{CC}1,2}$)	Input Power Supply Rejection Ratio	$V_{\text{CC}1,2} = 4.75\text{V}$ to 5.25V , $V_{\text{CC}0} = 5\text{V}$	●	22	25		dB
				15			dB
PSRR($V_{\text{CC}0}$)	Output Power Supply Rejection Ratio	$V_{\text{CC}0} = 4.75\text{V}$ to 5.25V , $V_{\text{CC}1,2} = 5\text{V}$	●	34	40		dB
				33			dB

Note 1: Stresses beyond those listed under Absolute Maximum Ratings may cause permanent damage to the device. Exposure to any Absolute Maximum Rating condition for extended periods may affect device reliability and lifetime.

Note 2: The LTC65611 is guaranteed to meet specified performance from -40°C to 85°C .

TYPICAL PERFORMANCE CHARACTERISTICS

**I_{SUPPLY} vs V_{SUPPLY}
Over Temperature**

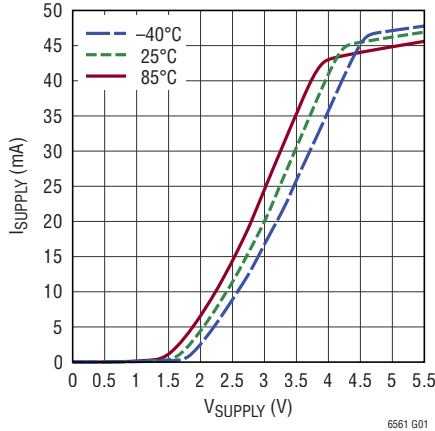

I_{CC} vs Temperature

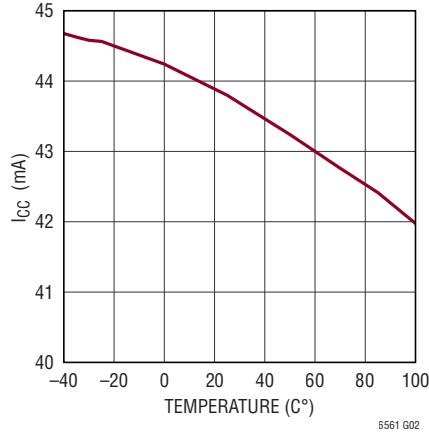

I_{CCO} vs Temperature

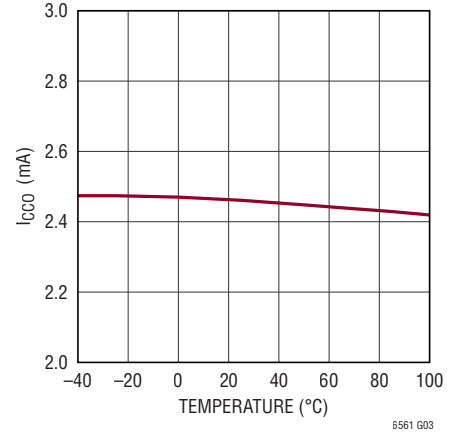

V_{IN} vs Temperature

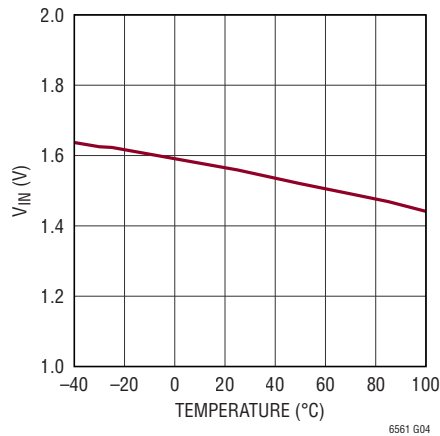

V_{REF} vs Temperature

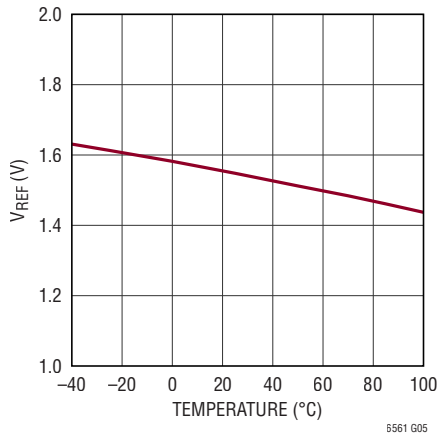

$V_{IN}-V_{REF}$ Offset vs Temperature

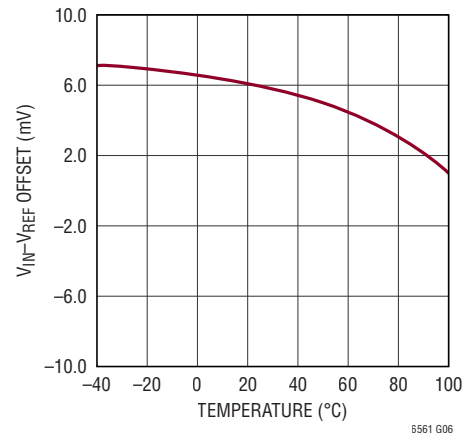

R_{IN} vs Temperature

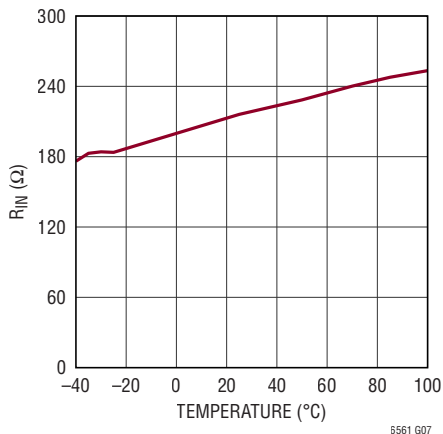

R_T Transpedance vs Temperature

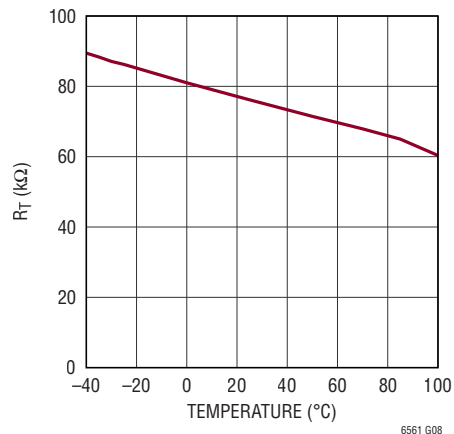

TYPICAL PERFORMANCE CHARACTERISTICS

V_{IN} vs I_{IN} Over Temperature

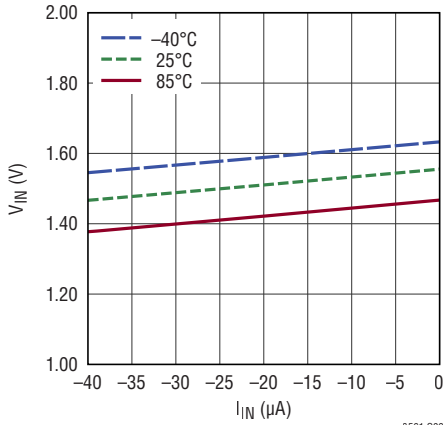

6561 G09

V_{OUT} vs I_{IN} Over Temperature

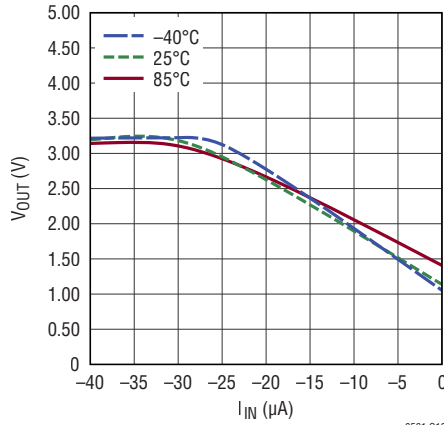

6561 G10

R_T Transimpedance vs I_{IN} Over Temperature

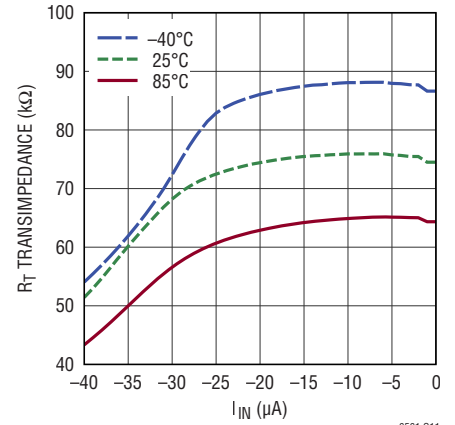

6561 G11

3dB Bandwidth vs Temperature Over $C_{IN,TOT}$

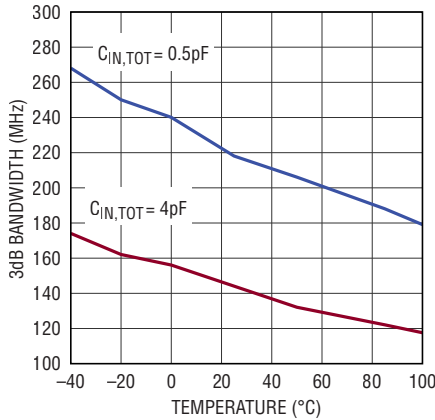

6561 G12

Input-Referred Noise Density with $C_{IN,TOT} = 0.5pF$

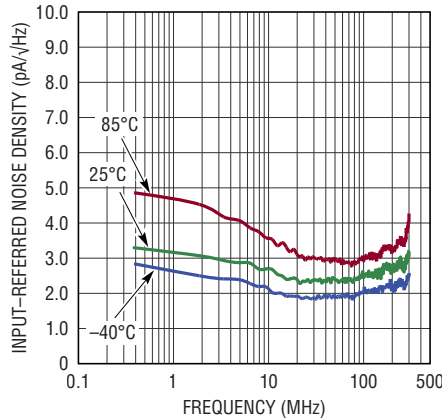

6561 G13

Input-Referred Noise Density with $C_{IN,TOT} = 4.0pF$

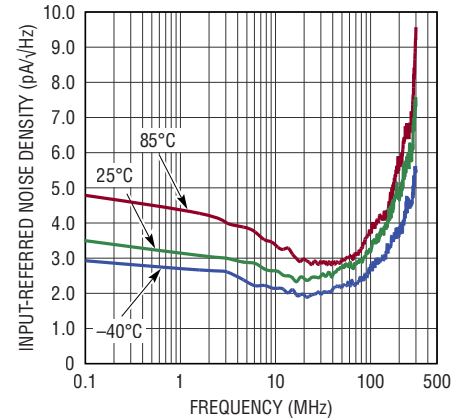

6561 G14

Integrated Input-Referred Noise vs Temperature with $C_{IN,TOT} = 0.5pF$

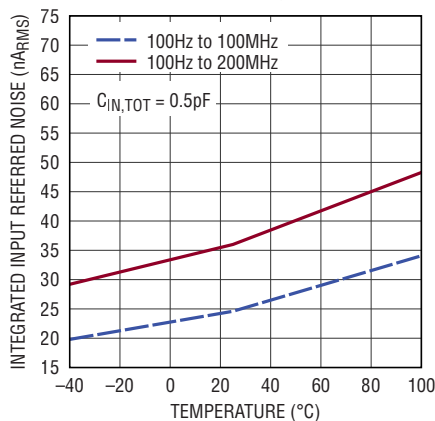

6561 G15

Integrated Input-Referred Noise vs Temperature with $C_{IN,TOT} = 4.0pF$

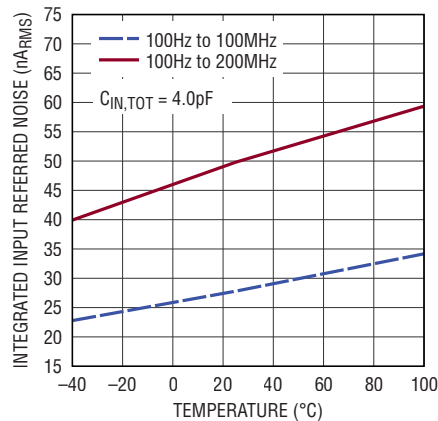

6561 G16

TYPICAL PERFORMANCE CHARACTERISTICS

S21(Gain) vs Frequency Over Temperature

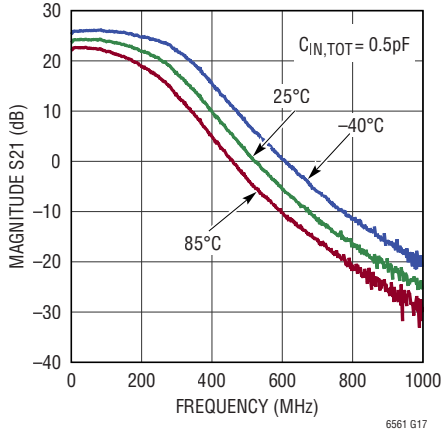

6561 G17

S22 vs Frequency Over Temperature

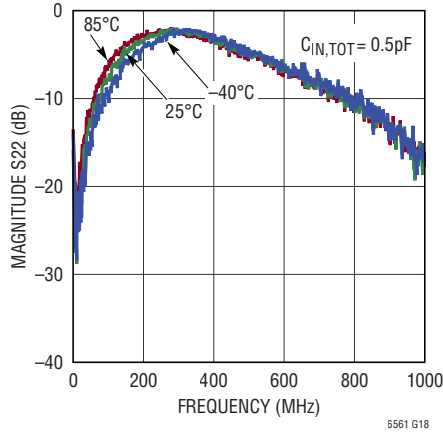

6561 G18

Stability Factor K vs Frequency Over Temperature

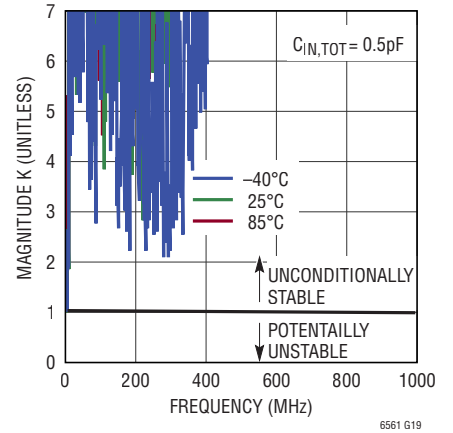

6561 G19

S21(Gain) vs Frequency Over Temperature

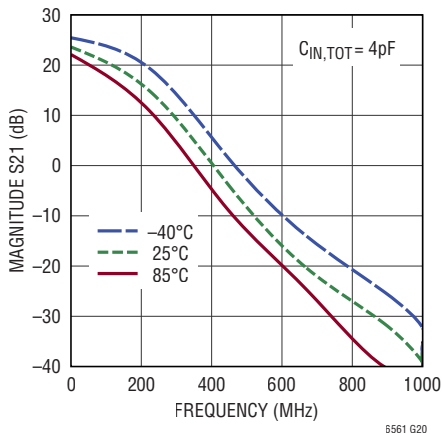

6561 G20

S22 vs Frequency Over Temperature

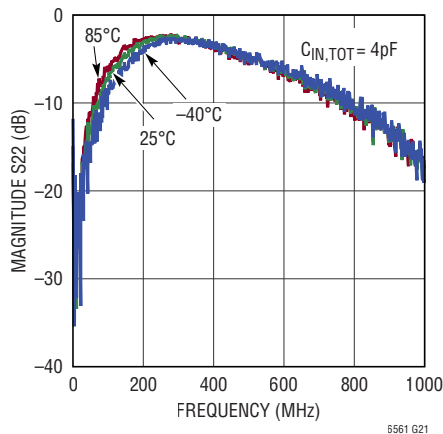

6561 G21

Stability Factor K vs Frequency Over Temperature

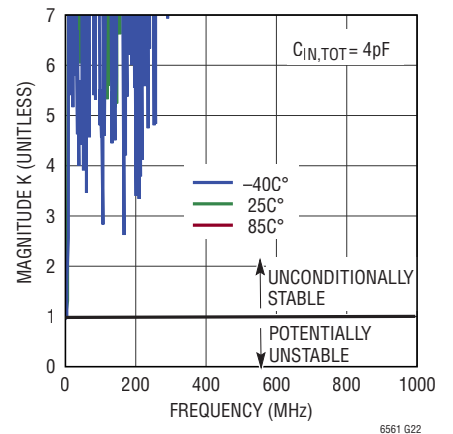

6561 G22

Ch to Ch Isolation vs Frequency Over Temperature

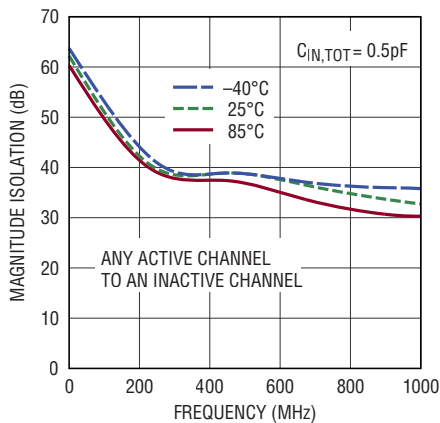

6561 G23

O_MUX Isolation vs Frequency Over Temperature

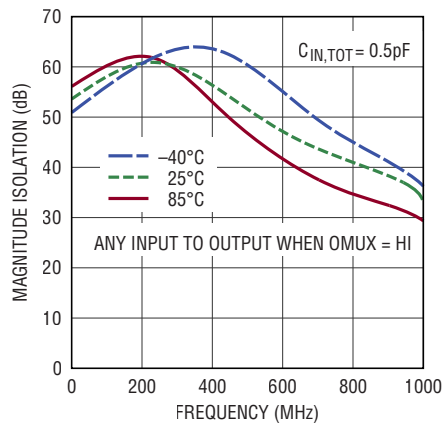

6561 G24

TYPICAL PERFORMANCE CHARACTERISTICS

**Pulse Response
Linear Range (2.5µA)**

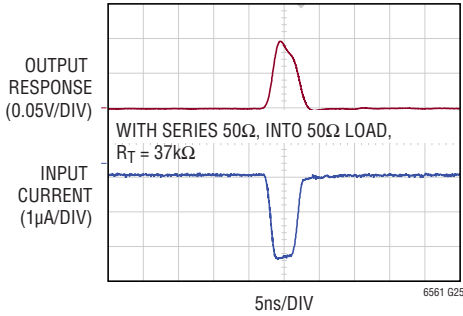

**Pulse Response
Linear Range (20µA)**

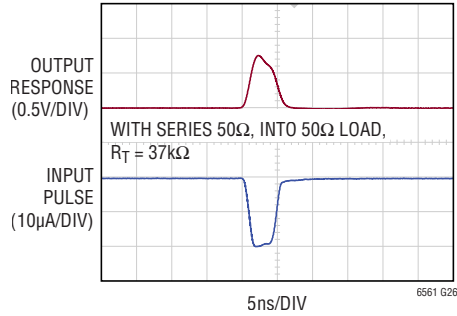

**Pulse Response
Overload Region (40µA)**

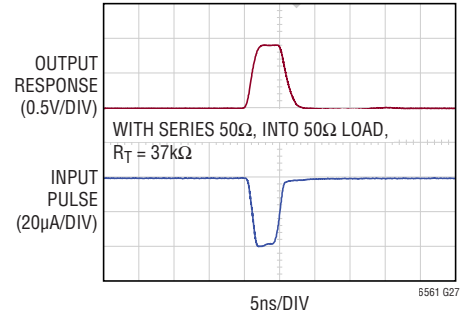

**Pulse Response
Overload Region (1mA)**

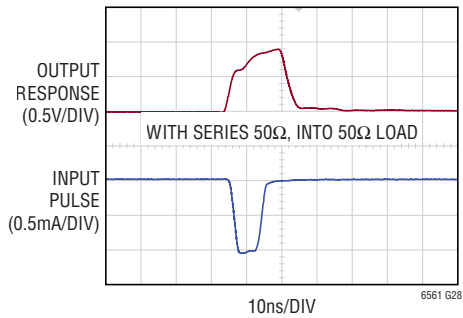

**Pulse Stretching
T = 25°C, Using FWHM**

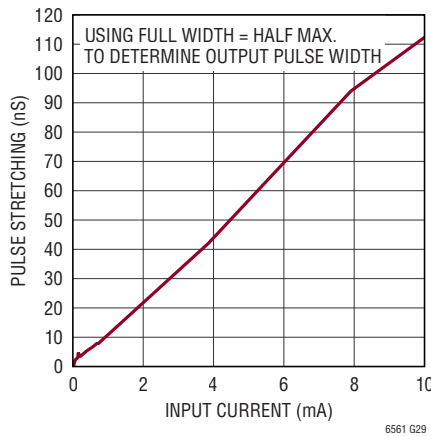

**Pulse Stretching Detailed
T = 25°C, Using FWHM**

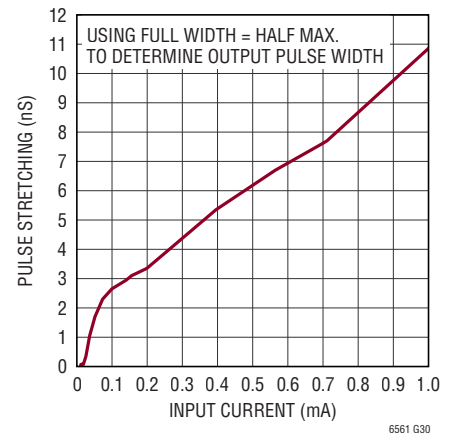

**Channel Select
Switching Time**

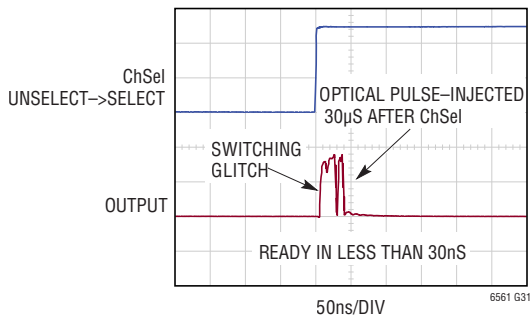

O_MUX Switching Time

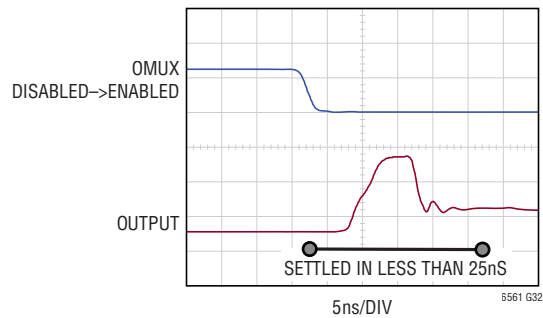

PIN FUNCTIONS

V_{CC0} (Pins 1, 18): Positive Power Supply for the Output Stage. Typically 5V. V_{CC0} can be tied to V_{CC1} or V_{CC2} for single supply operation. Between the positive supply and ground, bypass capacitors of 1000pF and 0.1μF should be placed as close to the part as possible. V_{CC0} pins are internally tied together.

CHSELO (Pin 2): LSB for Channel Selection. CMOS input. The CHSELO pin has a 29kΩ internal pulldown resistor. Default value is 0V.

V_{CC1}, V_{CC2} (Pins 3, 16): Positive Power Supply. Typically 5V. Between the positive supply and ground, bypass capacitors of 1000pF and 0.1μF should be placed as close to the part as possible. V_{CC1} (Pin 3) and V_{CC2} (Pin 16) are internally tied together.

V_{REF1}, V_{REF2}, V_{REF3}, V_{REF4} (Pins 4, 9, 10, 15): Reference Voltage Pin for Transimpedance Amplifier in Channel 1, 2, 3, and 4 Respectively. This pin sets the input DC voltage for each transimpedance amplifier. The V_{REF} pin has a Thevenin equivalent resistance of approximately 1.4k and can be overdriven by an external voltage. If no voltage is applied to V_{REF}, it will float to a default voltage of approximately 1.55V on a 5V supply. Each V_{REF} pin should be bypassed with a high quality ceramic bypass capacitor of at least 0.1μF. The bypass cap should be located close to its V_{REF} pin.

GND (Pins 5, 8, 11, 14, 21, 22, Exposed Pad Pin 25): Negative Power Supply. Normally tied to ground. All GND

pins and the exposed pad must be tied to the same voltage. The exposed pad (pin 25) should have multiple via holes to an underlying ground plane for low inductance and good heat transfer.

IN1, IN2, IN3, IN4 (Pin 6, 7, 12, 13): Input Pin for Transimpedance Amplifier for Channels 1, 2, 3, and 4 respectively. This pin is internally biased to 1.55V. See the applications section for specific recommendations.

O_MUX (Pin 17): Output MUX. CMOS Input. This pin is functional when multiple LTC6561s are combined at the output. When O_MUX is low, the output is enabled. When O_MUX is high, all 4 inputs are decoupled from the output. Default value is 0V. This MUX pin is ineffective unless a 2nd LTC6561 is DC-coupled at the output. See Applications section on how to use O_MUX to expand the channel count with multiple LTC6561's. The O_MUX pin has a 29kΩ internal pulldown resistor.

DNC (Pin 19): Do not connect.

OUTTERM (Pin 20): TIA Output with an Internal Series 50Ω Resistor.

OUT (Pin 23): TIA Output without an internal series 50Ω Resistor.

CHSEL1 (Pin 24): MSB for Channel Selection. CMOS input. The CHSEL1 pin has a 29kΩ internal pulldown resistor. Default value is 0V.

BLOCK DIAGRAM

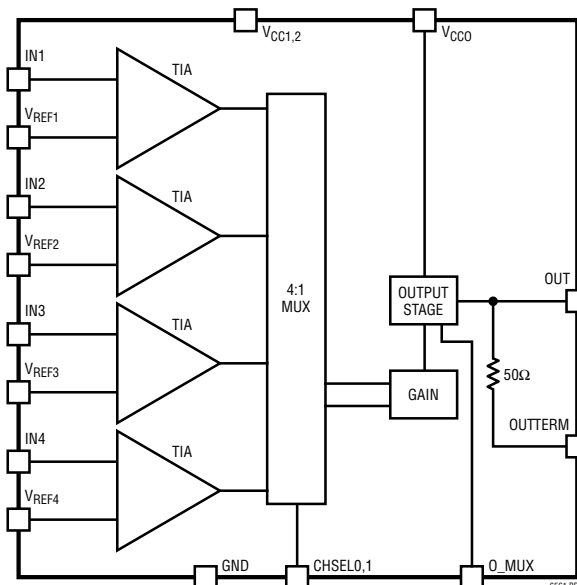

APPLICATIONS INFORMATION

CHANNEL SELECTION

There are four TIA inputs to the LTC6561. The active channel is selected using the two channel selection bits CHSEL0 and CHSEL1. When a channel is selected, its DC input voltage is approximately 1.5V; when deselected its input voltage drops to 1.0V. A reselected channel will not be active until its AC-coupling cap is recharged to 1.5V, leading to slow switching times. With an AC-coupling cap, switching time can stretch into the multiple μ S. When DC-coupled, the LTC6561 will switch channels in less than 50nS. Inactive channels have more than 45dB of isolation to the active channel to prevent cross-talk. It is critical to route adjacent channel input lines with ground isolation between them to minimize channel to channel coupling.

OUTPUT MUXing

The Output MUX (O_MUX) requires at least one additional LTC6561 devices to operate in a master/slave relationship. To MUX multiple LTC6561's they need to share a DC connection at their outputs. One LTC6561 output must be selected at all times by asserting its O_MUX pin low. To disable the rest of the outputs, drive the other O_MUX pins high. The chosen LTC6561 effectively commands the others. It is recommended to DC couple the outputs after the series 40-50 Ω resistor as this will limit reflection from unselected outputs. At least one LTC6561 output must be selected at all times.

In its default mode O_MUX is low, so the LTC6561 output is enabled. Obviously, if there is only one LTC6561, then setting the O_MUX pin high will not MUX anything, however the output will be isolated from all the inputs.

INPUT CAPACITANCE

As with most TIAs, bandwidth and rise time of the output pulse are a strong function of the input capacitance. To receive narrow pulses, a low capacitance APD sensor is recommended. As well, trace capacitance and parasitic pad capacitance should be minimized at the input. All LTC6561 plots reference $C_{IN,TOT}$ which is the total input capacitance including APD sensor, trace routing and parasitics. The LTC6561's MUX capability allows short input coupling

to individual APDs and a more compact solution size for APD arrays.

Internal protection circuitry at each TIA input can protect the LTC6561 even under strong overdrive conditions. Most application circuits will not need external protection diodes which add to the total input capacitance and slow the rise time. Output rise time can be estimated from the amplifier bandwidth using the following relationship:

$$RISETIME = \frac{0.35}{BW}$$

APD BIASING

Proper APD biasing is key to producing a high fidelity output and protecting both the APD and TIA. As suggested earlier a negatively biased APD provides the lowest input capacitance and allows the APD to be DC coupled to the TIA. To keep the optical gain stable the APD bias should be temperature compensated. Quenching resistors in series are required to limit the maximum current, thereby protecting the APD and TIA from damage. An example of a typical APD bias network is shown in Figure 5. Starting at the Negative bias input, two physically large 10KW resistors can dissipate the maximum pulse power. They are decoupled with a 1nF capacitor. Moving towards the APD, a second smaller quenching resistor 50 Ω is decoupled by two 0.047 μ F capacitors. This smaller quenching resistor acts to dampen ringing especially under high slew rates due to large optical inputs pulses. All capacitors must be rated for high voltage as APD bias voltages can run above 200V.

Dramatically Improving the LTC6561's Dynamic Range

While the LTC6561's 30 μ A of linear input range is quite respectable, it is possible to dramatically improve the range over which input current can be accurately measured. The measurement range can be increased from 30 μ A to at least 3mA, a 100X improvement in current measurement range! As the input current exceeds the linear range, the output pulse amplitude saturates. Once in saturation, the pulse width widens in a predictable manner.

APPLICATIONS INFORMATION

This behavior is demonstrated using the FT2563 evaluation board. This evaluation board uses a series 2k resistor to convert a voltage pulse to a current pulse as it is difficult to obtain a fast current pulse generator. The input is terminated in 50Ω so that current pulses of known quantity are generated at the TIA input using a voltage source. Sweeping the TIA pulse input current from 2.8μA to 3mA, we see that as the current surpasses the 30μA saturation point, the output pulse width increases (Figure 3b).

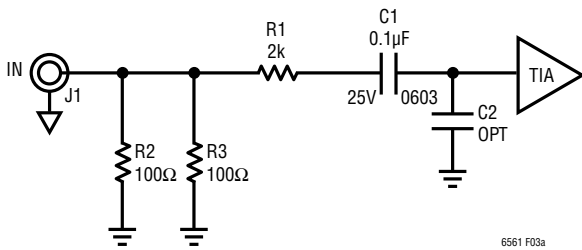

Figure 3a.

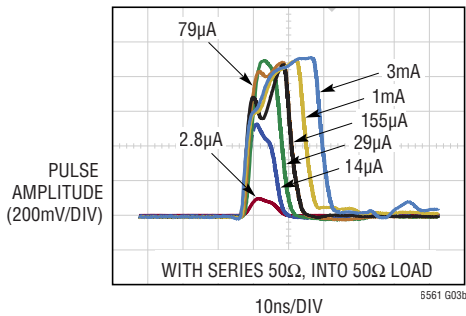

Figure 3b. Output Pulse Over Input Current

When we plot the pulse stretching (Output response width – input pulse width), we see that the stretching is linearly proportional to the input current. Below, the saturation point of 30μA the pulse stretching falls to zero. Here we have used the simple FWHM (Full Width Half Max) criteria to establish the pulse width. The pulse width is taken at half of the maximum swing usually around 0.45V. A more sophisticated algorithm could be used to gain greater accuracy assuming the pulse shape is accurately captured by an ADC. A plot of pulse stretching vs input current is shown in Figure 4a and Figure 4b showing greater detail at low input currents.

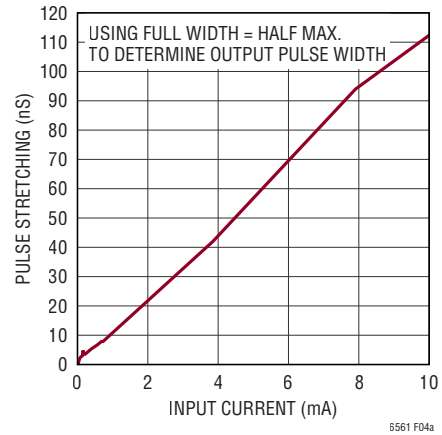

Figure 4a. Pulse Stretching T = 25°C, Using FWHM

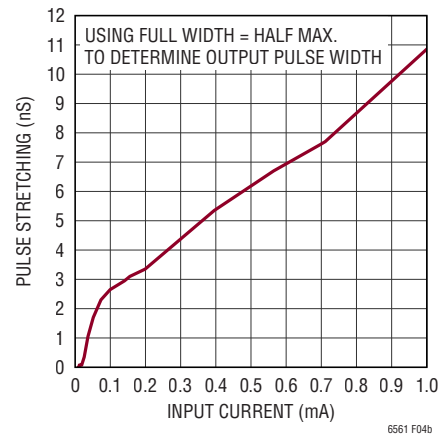
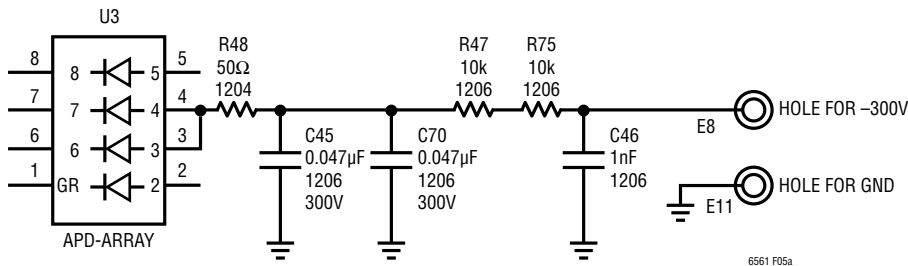

Figure 4b. Pulse Stretching Detailed T = 25°C, Using FWHM

The same pulse stretching has been demonstrated using optical excitation. Independently measuring the current generated during an optical pulse impinging on an APD is quite difficult. The parasitics of any measuring device will impair the actual pulse input (Figure 5). Using a balun across series resistor R48 feeding the APD, we can get an independent determination of APD current to the TIA for moderate laser input powers. Again, when this APD current is plotted versus pulse stretching, we find a nearly linear relationship under moderate illumination

APPLICATIONS INFORMATION



**Pulse Width vs APD Current
Optical Measurement**

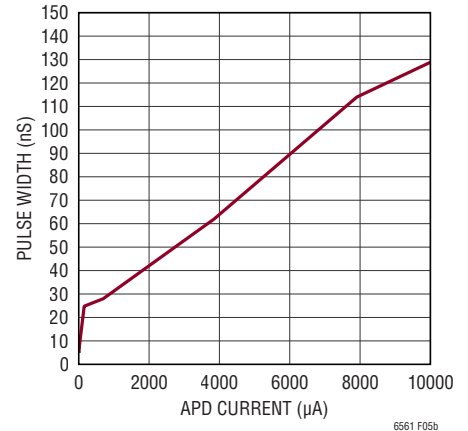

Figure 5. Typical APD Bias Circuit

Using a calibrated laser source we find that pulse stretching continues even at extremely high laser power levels of 50 Watts! At high illumination levels, the relationship no longer appears perfectly linear, but the potential to measure these high power levels is possible. Of course, with any system, a calibration of optical input power to pulse stretching should be done as the optical gain is a strong function of the APD reverse bias, temperature and the choice of APD.

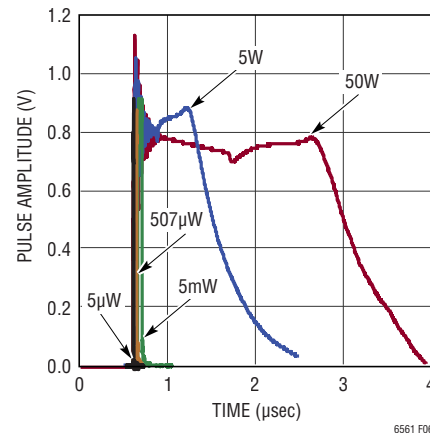
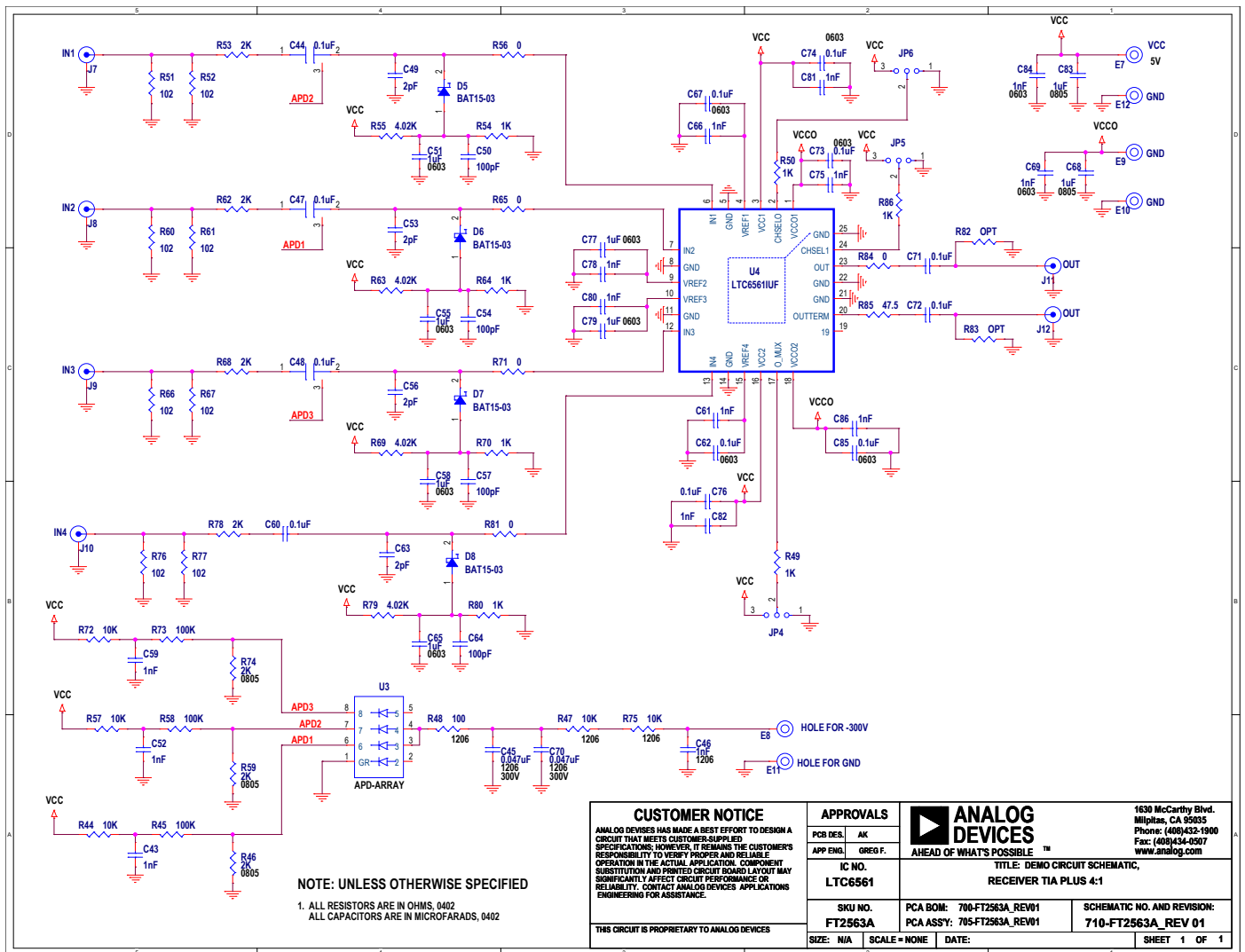
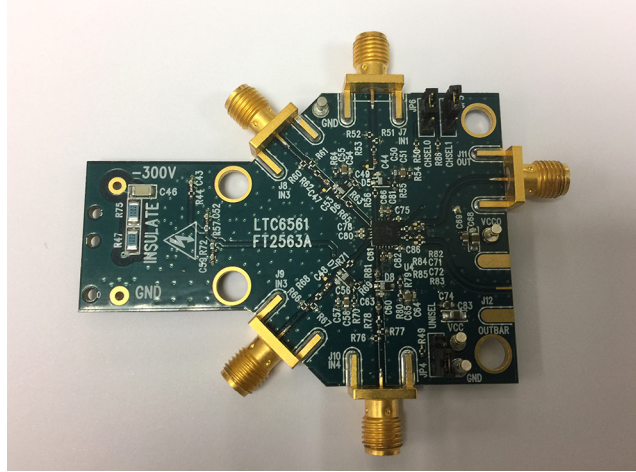

Figure 6. Pulse Width vs Input Hi Power Optical

APPLICATIONS INFORMATION

FT2563A 4-Channel Demonstration Circuit for Optical or Electrical Evaluation



APPLICATIONS INFORMATION

FT2724 16-Channel Demonstration Circuit for Optical Evaluation

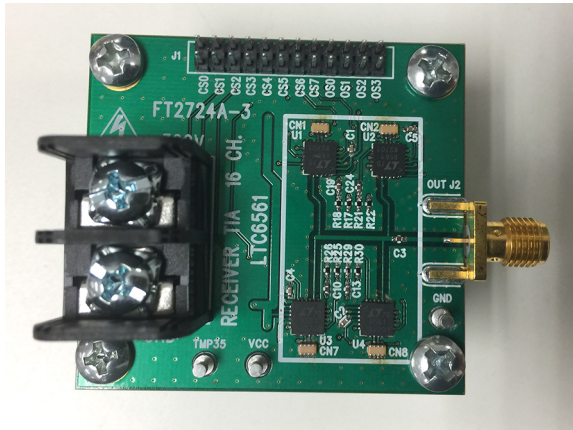

FT2724 Front Side

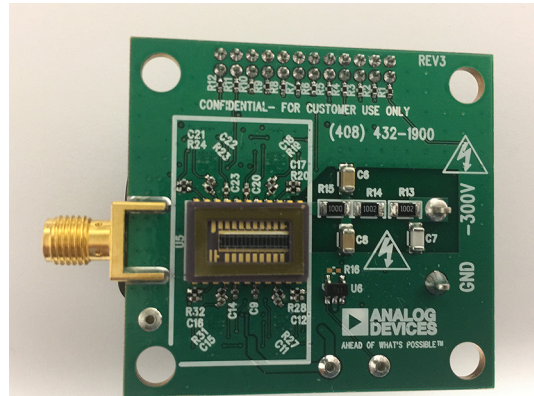

FT2724 Back Side

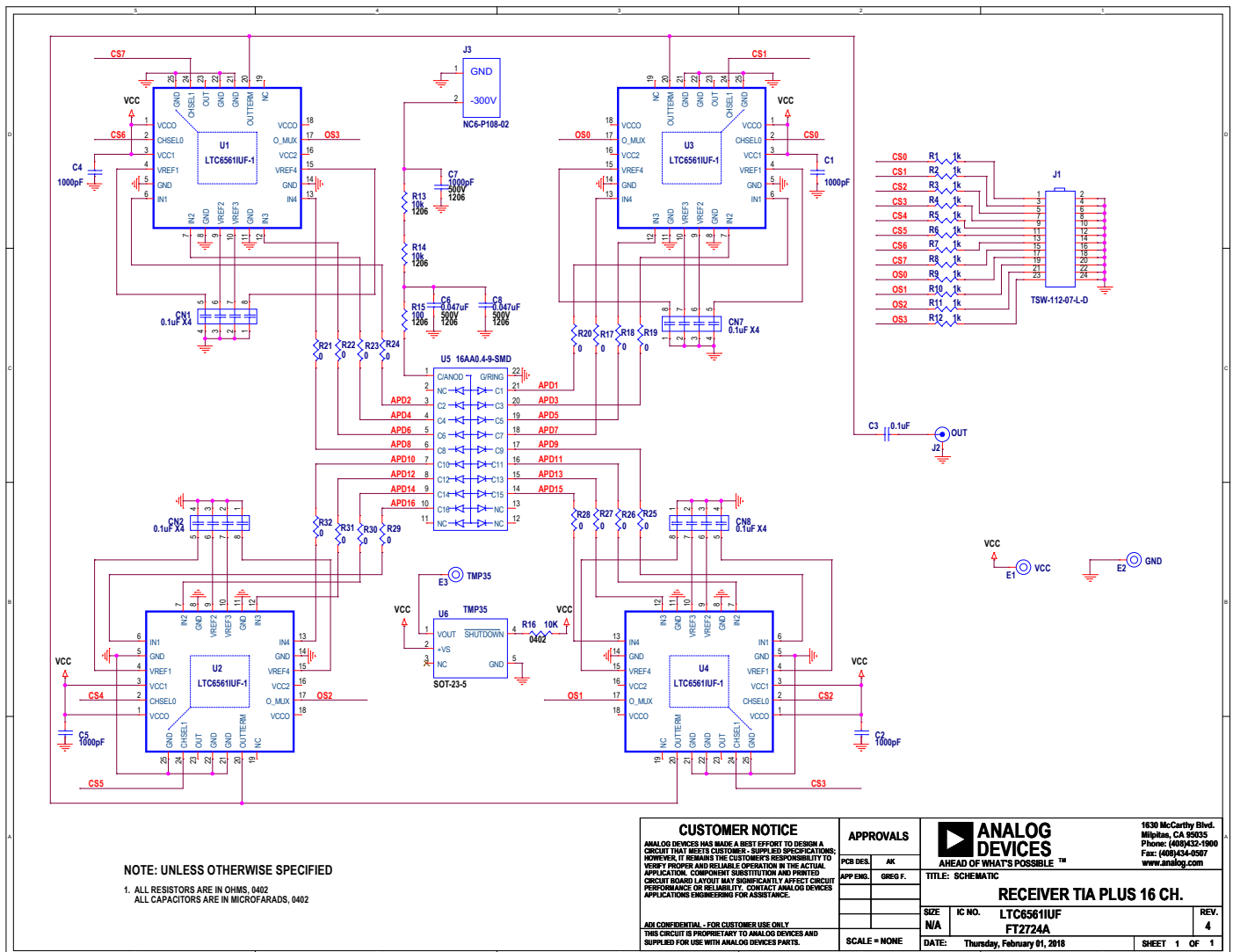

APPLICATIONS INFORMATION

LB2800 16:4 Channel Demonstration Circuit for Optical Evaluation

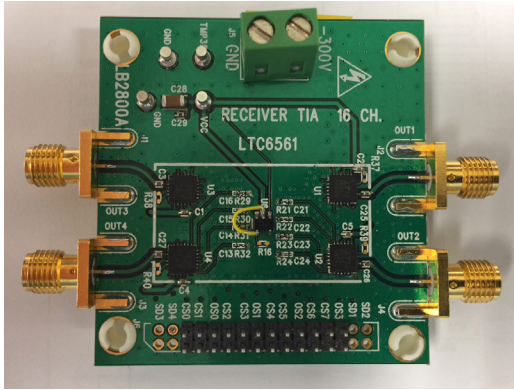

LB2800 Front Side

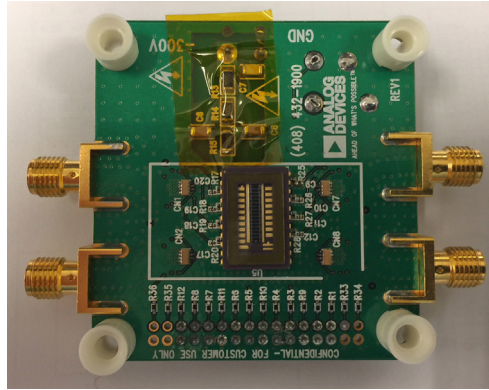

LB2800 Back Side

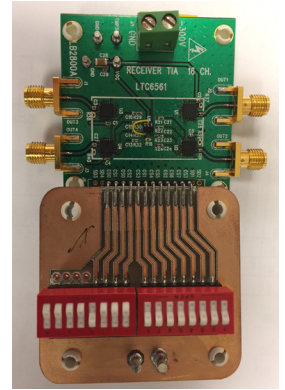

FT2724 with Switch Board

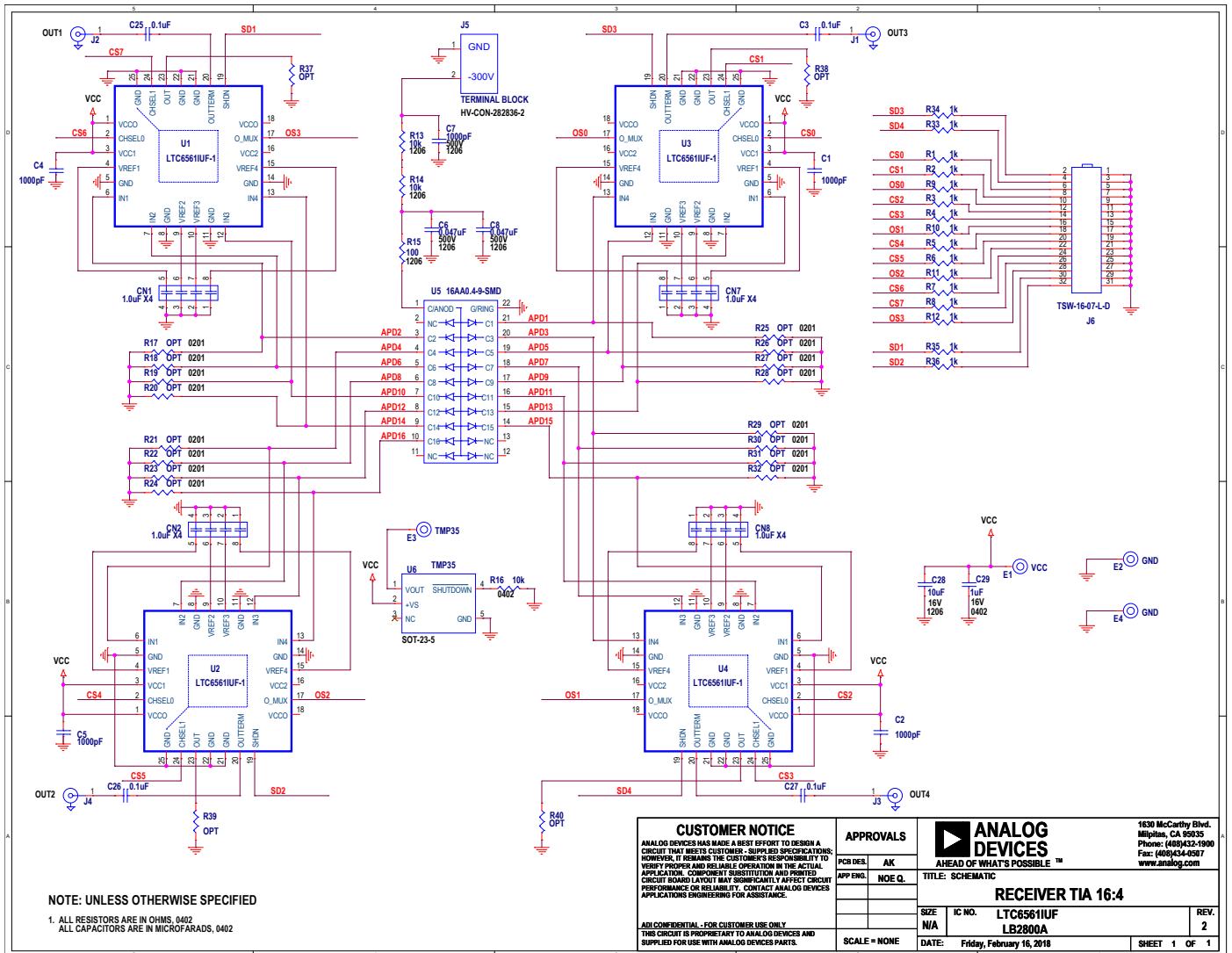

TYPICAL APPLICATION

Typical Application with Multiplexed Output

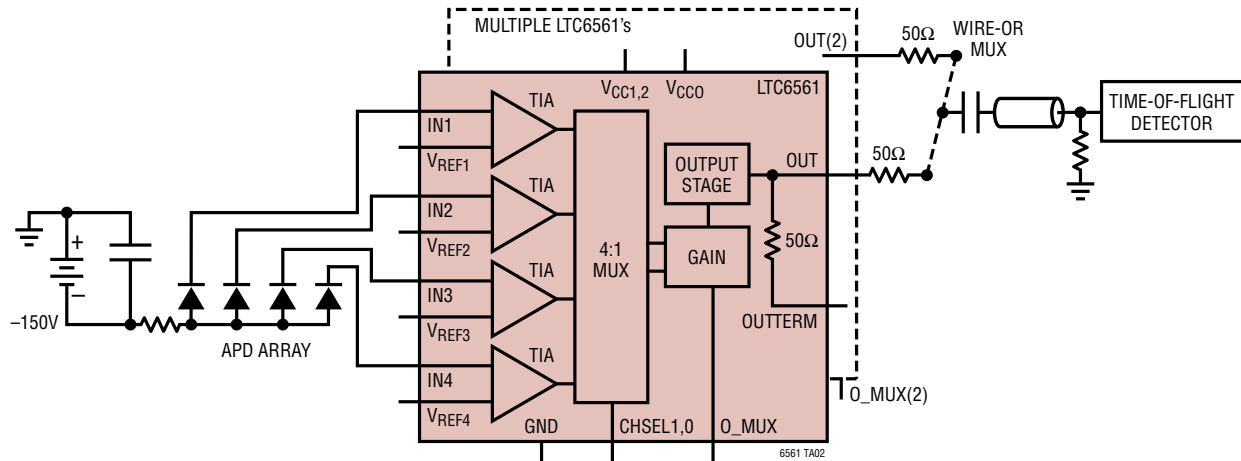

RELATED PARTS

PART NUMBER	DESCRIPTION	COMMENTS
LTC6268	500MHz Ultra Low Bias Current FET Input Op Amp	GBW = 500MHz, -3dB BW = 350MHz, Ib = ±3fA
LTC6268-10	4GHz Ultra Low Bias Current FET Input Op Amp	De-Comped Version of the LTC6268, GBW = 4GHz
LTC6244	Dual 50MHz, Low Noise, Rail-to-Rail CMOS Op Amp	GBW = 50MHz, Ib = 1pA
LTC6240/LTC6241/LTC6242	Single/Dual/Quad 18MHz, Low Noise, Rail-to-Rail Output CMOS Op Amps	GBW = 18MHz, Ib = 0.2pA, 0.1Hz-10Hz, Noise 550nVp-p
LTC6409	10GHz Bandwidth, 1.1nV/√Hz Differential Amplifier/ADC Driver	GBW = 10GHz, en = 1.1nV/√Hz