

PERFORMANCE SPECIFICATIONS SUMMARY AND ORDERING GUIDE ①														
Root Models ①	Output						Input				Efficiency			
	V _{out} (Volts)	I _{out} (Amps)	Power (Watts)	R/N (mVp-p)		Regulation (Max.) ②		V _{in} Nom. (Volts)	Range (Volts)	I _{in} no load (mA)	I _{in} full load (Amps)	Min.	Typ.	
				Typ.	Max.	Line	Load							
Discontinued	UCQ-1.2/40-D24P-C	1.2	40	48	Please contact Murata Power Solutions for further information.									
Discontinued	UCQ-1.2/30-D48N-C	1.2	30	36	50	100	±0.125%	±0.25%	48	36-75	30	0.90	81%	83%
Discontinued	UCQ-1.5/25-D48N-C	1.5	25	37.5	50	80	±0.125%	±0.25%	48	36-75	50	0.94	81%	83%
Discontinued	UCQ-1.5/40-D48N-C	1.5	40	60	50	100	±0.125%	±0.25%	48	36-75	50	1.45	85%	86%
Discontinued	UCQ-1.8/30-D48N-C	1.8	30	54	80	100	±0.125%	±0.25%	48	36-75	45	1.31	83%	86%
Discontinued	UCQ-1.8/40-D48N-C	1.8	40	72	50	100	±0.1%	±0.2%	48	36-75	30	1.70	86%	88%
Discontinued	UCQ-2.5/40-D24P-C	2.5	40	100	80	120	±0.125%	±0.25%	24	18-36	120	4.96	82%	84%
Discontinued	UCQ-2.5/30-D48N-C	2.5	30	75	50	100	±0.125%	±0.25%	48	36-75	50	1.80	85%	87%
Discontinued	UCQ-3.3/35-D24P-C	3.3	35	115.5	80	120	±0.25%	±0.25%	24	18-36	130	5.41	87%	89%
Discontinued	UCQ-3.3/20-D48N-C	3.3	20	66	50	80	±0.125%	±0.25%	48	36-75	50	1.53	88.5%	90%
Available	UCQ-3.3/30-D48N-C	3.3	30	99	50	80	±0.125%	±0.25%	48	36-75	50	2.3	89.5%	91%
Discontinued	UCQ-3.3/40-D48N-C	3.3	40	132	60	100	±0.1%	±0.2%	48	36-75	30	3.06	89%	90%
Discontinued	UCQ-5/20-D24P-C	5	20	100	50	60	±0.125%	±0.25%	24	18-36	160	4.55	88%	91.5%
Available	UCQ-5/20-D48N-C	5	20	100	35	55	±0.125%	±0.25%	48	36-75	80	2.26	89%	92%
To Be Discontinued*	UCQ-5/25-D48N-C	5	25	125	50	100	±0.125%	±0.25%	48	36-75	30	2.89	88%	90%
To Be Discontinued*	UCQ-12/8.3-D48N-C	12	8.3	99.6	100	150	±0.125%	±0.25%	48	36-75	80	2.28	90%	91%
Discontinued	UCQ-15/6.7-D48N-C	15	6.7	100.5	100	150	±0.125%	±0.25%	48	36-75	100	2.28	90%	92%

As of October 2016, ONLY the following part numbers will be available: UCQ-3.3/30-D48N-C; UCQ-5/20-D48N-C; UCQ-5/20-D48NB-C; UCQ-5/25-D48NB-C

***LAST TIME BUY: 3/31/2017. CLICK HERE FOR DISCONTINUANCE NOTICES.**

- ① Please refer to the part number structure for additional ordering part numbers and options.
- ② All specifications are at nominal line voltage and full load, +25 deg.C unless otherwise noted. See detailed specifications. Output capacitors are 1 µF ceramic || 10 µF electrolytic. I/O caps are necessary for our test equipment and may not be needed for your application.

Outline dimensions: 2.3 × 1.45 × 0.40 inches
58.4 × 36.8 × 10.2 mm

Pinout: P32 (all models)

PART NUMBER STRUCTURE

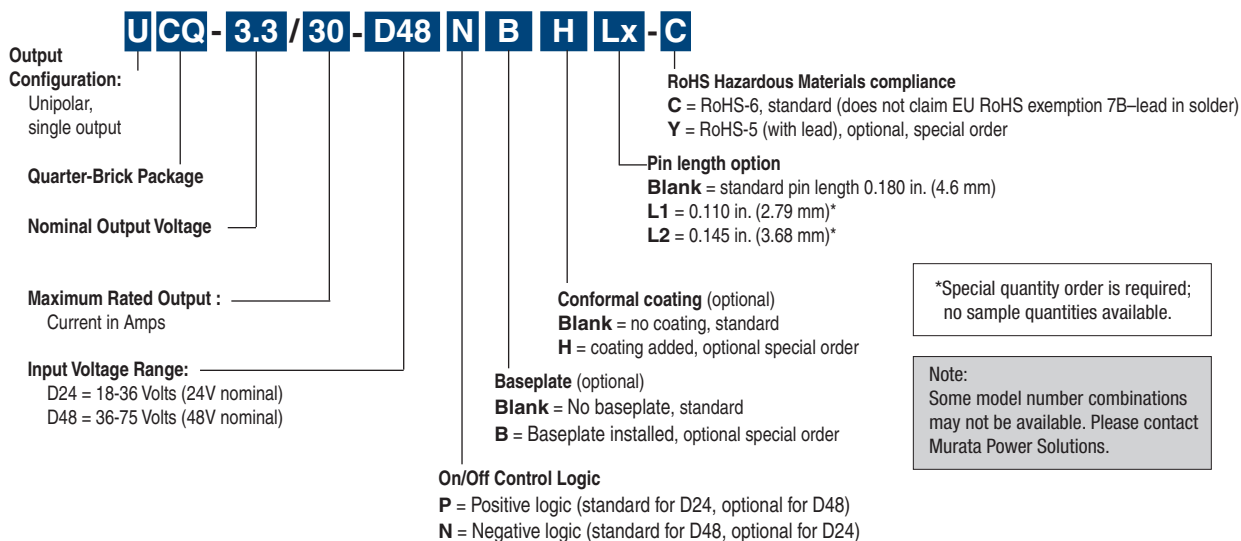

FUNCTIONAL SPECIFICATIONS

	UCQ-1.2/30-D48	UCQ-1.5/25-D48	UCQ-1.5/40-D48	UCQ-1.8/30-D48	UCQ-1.8/40-D48
Input					
Input voltage range	See ordering guide.				
Start-up threshold, Volts	34	34	34	34	34
Undervoltage shutdown, V	33	32	32.5	32.5	32
Oversvoltage shutdown	none				
Reflected (back) ripple current, mA pk-pk	10-30, model dependent				
Input Current					
Full load conditions	See ordering guide.				
Inrush transient, A ² sec	0.05				
Output short circuit, mA	50-200, model dependent				
Low line (V _{IN} = min.), Amps	1.23	1.26	1.96	1.74	2.30
Standby mode, mA (Off, UV, OT shutdown)	1-10, model dependent				
Internal input filter type	Pi-type	L-C	Pi-type	Pi-type	Pi-type
Reverse polarity protection	None, install external fuse.				
Remote On/Off Control					
Positive logic (P model suffix)	OFF = Ground pin to +0.8V ON = Open or +3.5 to +13.5V max				
Negative logic (N model suffix)	OFF = Open or +3.5 to +13.5V ON = Ground pin to +0.8V max				
Current, mA	1				
Output					
Voltage output range	See ordering guide.				
Voltage output accuracy	±1% of V _{NOM.} , (50% load)				
Adjustment range, % of V _{NOM.}	±10%	-20 + 10	±10%	±10%	±10%
Temperature coefficient	±0.02% of V _{OUT} range per °C				
Minimum loading	No minimum loading.				
Remote sense compensation	+10%				
Ripple/noise (20 MHz bandwidth)	See ordering guide.				
Line/Load regulation	See ordering guide.				
Efficiency	See ordering guide.				
Maximum capacitive loading, µF low ESR <0.02Ω max., resistive load	1,000	10,000	10,000	4,700	10,000

① Specs are typical unless noted.

FUNCTIONAL SPECIFICATIONS

	UCQ-2.5/40-D24	UCQ-2.5/30-D48	UCQ-3.3/35-D24	UCQ-3.3/20-D48	UCQ-3.3/30-D48
Input					
Input voltage range	See ordering guide.				
Start-up threshold, Volts	16.8	34	17	35	35
Undervoltage shutdown, V	15	32	15	34	34
Oversvoltage shutdown	none				
Reflected (back) ripple current, mA pk-pk	10-30, model dependent				
Input Current					
Full load conditions	See ordering guide.				
Inrush transient, A ² sec	0.05				
Output short circuit, mA	50-200, model dependent				
Low line (V _{IN} = min.), Amps	6.69	2.39	7.21	2.04	3.02
Standby mode, mA (Off, UV, OT shutdown)	1-10, model dependent				
Internal input filter type	Pi	L-C	L-C	Pi	Pi
Reverse polarity protection	None, install external fuse.				
Remote On/Off Control					
Positive logic (P model suffix)	OFF = Ground pin to +0.8V ON = Open or +3.5 to +13.5V max				
Negative logic (N model suffix)	OFF = Open or +3.5 to +13.5V ON = Ground pin to +0.8V max				
Current, mA	1				
Output					
Voltage output range	See ordering guide.				
Voltage output accuracy	±1% of V _{NOM.} , (50% load)				
Adjustment range, % of V _{NOM.}	-20 + 10	-20 + 10	±10%	-10 to + 10%	
Temperature coefficient	±0.02% of V _{OUT} range per °C				
Minimum loading	No minimum loading.				
Remote sense compensation	+10%				
Ripple/noise (20 MHz bandwidth)	See ordering guide.				
Line/Load regulation	See ordering guide.				
Efficiency	See ordering guide.				
Maximum capacitive loading, µF low ESR <0.02Ω max., resistive load	10,000	10,000	10,000	10,000	10,000

① Specs are typical unless noted.

FUNCTIONAL SPECIFICATIONS

	UCQ-3.3/40-D48	UCQ-5/20-D24	UCQ-5/20-D48	UCQ-5/25-D48	UCQ-12/8.3-D48	UCQ-15/6.7-D48N-C
Input						
Input voltage range	See ordering guide					
Start-up threshold, Volts	33	17	35	35	35	34
Undervoltage shutdown, V	31.5	16	34	34	34	31.5
Overvoltage shutdown	none					
Reflected (back) ripple current, mA pk-pk	10-30, model dependent.					60 max.
Input Current						
Full load conditions	See ordering guide.					
Inrush transient, A ² sec	0.1	0.05				0.03
Output short circuit, mA	1200	50-200, model dependent				120
Low line (V _{IN} = min.), Amps	4.12	6.04	3.02	3.82	3.04	3.03
Standby mode, mA (Off, UV, OT shutdown)	1-10, model dependent					
Internal input filter type	Pi	L-C	L-C	L-C	L-C	Pi
Reverse polarity protection	None, install external fuse.					
Remote On/Off Control						
Positive logic (P model suffix)	OFF = Ground pin to +0.8V ON = Open or +3.5 to +13.5V max				OFF = Ground pin or to +1V. ON = Open or +2.5 to +13.5V	
Negative logic (N model suffix)	OFF = Open or +3.5 to +13.5V ON = Ground pin to +0.8V max				OFF = Open or +2.5 to +13.5V ON = Ground pin or to +1V.	
Current, mA	1					
Output						
Voltage output range	See ordering guide.					
Voltage output accuracy	±1% of V _{NOM.} , (50% load)					
Adjustment range, % of V _{NOM.}	-10 to +10%					
Temperature coefficient	±0.02% of V _{OUT} range per °C.					
Minimum loading	No minimum loading.					
Remote sense compensation	+10%					
Ripple/noise (20 MHz bandwidth)	See ordering guide.					
Line/Load regulation	See ordering guide.					
Efficiency	See ordering guide.					
Maximum capacitive loading, µF low ESR <0.02Ω max., resistive load	10,000	10,000	10,000	10,000	1,000	1000

① Specs are typical unless noted.

FUNCTIONAL SPECIFICATIONS

	UCQ-1.2/30-D48	UCQ-1.5/25-D48	UCQ-1.5/40-D48	UCQ-1.8/30-D48	UCQ-1.8/40-D48
Isolation Voltage					
Input to Output, Volts min.	2250				
Input to baseplate, Volts min.	1500				
Baseplate to output, Volts min.	1500				
Isolation resistance, MΩ	10-100, model dependent				
Isolation capacitance, pF	1000				
Isolation safety rating	Basic insulation				
Miscellaneous					
Current limit inception (98% of V _{OUT} , after warmup), Amps	35	35	49	35	49
Short circuit protection method	Current limiting, hiccup autorestart. Remove overload for recovery.				
Short circuit current, Amps	5				
Short circuit duration	Continuous, output shorted to ground. No damage.				
Overvoltage protection, Volts (via magnetic feedback)	1.8	1.8	1.95	2.7 V max	2.2
Dynamic characteristics					
Dynamic load response (50-75-50% load step)	200 μSec to ±1% of final value	200 μSec to ±1% of final value	50 μSec to ±1% of final value	100 μSec to ±1% of final value	50 μSec to ±1% of final value
Start-up time					
V _{IN} to V _{OUT} regulated, mSec	10 max.				
Remote On/Off to V _{OUT} regulated, mSec	10 max.				
Switching frequency, KHz	350 ± 20	440 ± 40	400 ± 40	400	380 ± 40
Environmental					
Calculated MTBF	2M hours	2.1M hours	2.2M hours	2M hours	2.1M hours
Operating temperature range, °C See Derating curves.	-40 to +85, with derating				
Operating case temperature, °C (no derating)	-40 to +120, model dependent				
Storage temperature range, °C	-55 to +125				
Thermal protection/shutdown, °C	110-125, model dependent				
Relative humidity	To +85°C/85%, non-condensing				

① Specs are typical unless noted.

FUNCTIONAL SPECIFICATIONS

	UCQ-2.5/40-D24	UCQ-2.5/30-D48	UCQ-3.3/35-D24	UCQ-3.3/20-D48	UCQ-3.3/30-D48
Isolation Voltage					
Input to Output, Volts min.	2250				
Input to baseplate, Volts min.	1500				
Baseplate to output, Volts min.	1500				
Isolation resistance, MΩ	10-100, model dependent				
Isolation capacitance, pF	1000				
Isolation safety rating	Basic insulation				
Miscellaneous					
Current limit inception (98% of V _{OUT} , after warmup), Amps	46	37	41	24	35
Short circuit protection method	Current limiting, hiccup autorestart. Remove overload for recovery.				
Short circuit current, Amps	5		12		5
Short circuit duration	Continuous, output shorted to ground. No damage.				
Overvoltage protection, Volts (via magnetic feedback)	2.95	2.95	4	4.6	4
Dynamic characteristics					
Dynamic load response (50-75-50% load step)	200 μSec to ±1% of final value	200 μSec to ±1% of final value	200 μSec to ±1% of final value	200 μSec to ±1.5% of final value	200 μSec to ±1% of final value
Start-up time					
V _{IN} to V _{OUT} regulated, mSec	10 max.				
Remote On/Off to V _{OUT} regulated, mSec	10 max.				
Switching frequency, KHz	480	480 ± 30	350 ± 10	330 ± 40	330 ± 40
Environmental					
Calculated MTBF	2.1M hours	2.2M hours	1.7M hours	1.8M hours	1.7M hours
Operating temperature range, °C See Derating curves.	-40 to +85, with derating				
Operating case temperature, °C (no derating)	-40 to +120, model dependent				
Storage temperature range, °C	-55 to +125				
Thermal protection/shutdown, °C	110-125, model dependent				
Relative humidity	To +85°C/85%, non-condensing				

① Specs are typical unless noted.

FUNCTIONAL SPECIFICATIONS

	UCQ-3.3/40-D48	UCQ-5/20-D24	UCQ-5/20-D48	UCQ-5/25-D48	UCQ-12/8.3-D48	UCQ-15/6.7-D48N-C
Isolation Voltage						
Input to Output, Volts min.	2250					
Input to baseplate, Volts min.	1500					
Baseplate to output, Volts min.	1500					
Isolation resistance, MΩ	10-100, model dependent					
Isolation capacitance, pF	1000					
Isolation safety rating	Basic insulation					
Miscellaneous						
Current limit inception (98% of V _{OUT} , after warmup), Amps	49	26	22	27	10	9
Short circuit protection method	Current limiting, hiccup autorestart. Remove overload for recovery.					
Short circuit current, Amps	15	5	5	5	TBD	2
Short circuit duration	Continuous, output shorted to ground. No damage.					
Overvoltage protection, Volts (via magnetic feedback)	4.25	6.25	TBD	6.2	14.4	18
Dynamic characteristics						
Dynamic load response (50-75-50% load step)	50 μSec to ±1% of final value	200 μSec to ±1% of final value	200 μSec to ±1% of final value	200 μSec to ±1% of final value	200 μSec to ±1% of final value	150 μSec to ±2% of final value
Start-up time						
V _{IN} to V _{OUT} regulated, mSec	5	4	10 max.	10 max.	10 max.	10 max.
Remote On/Off to V _{OUT} regulated, mSec	5	4	10 max.	10 max.	10 max.	10 max.
Switching frequency, KHz	360 ± 20	400 ± 24	315 ± 30	315 ± 30	330 ± 40	300 ± 30 KHz
Environmental						
Calculated MTBF	2.2M hours	2.2M hours	TBD	1.7M hours	1.8M hours	TBD
Operating temperature range, °C. See Derating curves.	-40 to +85, with derating					
Operating case temperature, °C (no derating)	-40 to +120, model dependent					-40 to +110
Storage temperature range, °C	-55 to +125					
Thermal protection/shutdown, °C	110-125, model dependent					
Relative humidity	To +85°C/85%, non-condensing					

① Specs are typical unless noted.

FUNCTIONAL SPECIFICATIONS

	UCQ-1.2/30-D48	UCQ-1.5/25-D48	UCQ-1.5/40-D48	UCQ-1.8/30-D48	UCQ-1.8/40-D48
Physical					
Outline dimensions	See mechanical specs.				
Pin material	Copper alloy				
Pin diameter	0.040/0.062 inches (1.016/1.575 mm)				
Pin finish	Nickel underplate with gold overplate				
Weight, ounces	0.9	1.06	0.9	0.9	1.23
Weight, grams	25	30	25	25	35
Electromagnetic interference	Designed to meet EN55022/CISPR22 (External filter required)				
Safety	Designed to meet UL 60950-1, CSA C22.2 No.60950-1, IEC/EN 60950-1				

	UCQ-2.5/40-D24	UCQ-2.5/30-D48	UCQ-3.3/35-D24	UCQ-3.3/20-D48	UCQ-3.3/30-D48
Physical					
Outline dimensions	See mechanical specs.				
Pin material	Copper alloy				
Pin diameter	0.040/0.062 inches (1.016/1.575 mm)				
Pin finish	Nickel underplate with gold overplate				
Weight, ounces	1.06	1.06	1.06	0.7	1.06
Weight, grams	30	30	30	20	30
Electromagnetic interference	Designed to meet EN55022/CISPR22 (External filter required)				
Safety	Designed to meet UL 60950-1, CSA C22.2 No.60950-1, IEC/EN 60950-1				

	UCQ-3.3/40-D48	UCQ-5/20-D24	UCQ-5/20-D48	UCQ-5/25-D48	UCQ-12/8.3-D48	UCQ-15/6.7-D48N-C
Physical						
Outline dimensions	See mechanical specs.					
Pin material	Copper alloy					
Pin diameter	0.040/0.062 inches (1.016/1.575 mm)					
Pin finish	Nickel underplate with gold overplate					
Weight, ounces	1.25	1.06	1.06	1.06	1.13	1.034
Weight, grams	35.5	30	30	30	32	29.3
Electromagnetic interference	Designed to meet EN55022/CISPR22 (External filter required)					
Safety	Designed to meet UL 60950-1, CSA C22.2 No.60950-1, IEC/EN 60950-1					

① Specs are typical unless noted.

Specification Notes

- (1) All models are tested and specified with external 1110 μF ceramic/tantalum output capacitors no external input capacitor. All capacitors are low ESR types. These capacitors are necessary to accommodate our test equipment and may not be required to achieve specified performance in your applications. All models are stable and regulate within spec under no-load conditions. All specifications are typical unless noted. General conditions for Specifications are +25 deg.C, V_{IN} and V_{OUT} = nominal, full load. Adequate airflow must be supplied for extended testing under power.
- (2) Input Ripple Current is tested and specified over a 5 Hz to 20 MHz bandwidth. Input filtering is $C_{\text{IN}} = 33 \mu\text{F}$, 100V tantalum, $C_{\text{EUS}} = 220 \mu\text{F}$, 100V electrolytic, $L_{\text{EUS}} = 12 \mu\text{H}$.
- (3) Note that Maximum Power Derating curves indicate an average current at nominal input voltage. At higher temperatures and/or lower airflow, the DC-DC converter will tolerate brief full current outputs if the total RMS current over time does not exceed the Derating curve. All Derating curves are presented at sea level altitude. Be aware of reduced power dissipation with increasing altitude.
- (4) Mean Time Before Failure is calculated using the Telcordia (Belcore) SR-332 Method 1, Case 3, ground fixed conditions, Tpcboard = +25 deg.C, full output load, natural air convection.
- (5) The On/Off Control is normally controlled by a switch or open collector or open drain transistor. But it may also be driven with external logic or by applying appropriate external voltages which are referenced to Input Common.
- (6) Short circuit shutdown begins when the output voltage degrades approximately 2% from the selected setting.
- (7) The outputs are not intended to sink appreciable reverse current.
- (8) Output noise may be further reduced by adding an external filter. See I/O Filtering and Noise Reduction.
- (9) All models are fully operational and meet published specifications, including "cold start" at -40 C.
- (10) Regulation specifications describe the deviation as the line input voltage or output load current is varied from a nominal midpoint value to either extreme.
- (11) Output accuracy is dependent on user-supplied trim resistors. To achieve high accuracy, use $\pm 1\%$ or better tolerance metal-film resistors mounted close to the converter.
- (12) Output current limit and short circuit protection is non-latching. When the overcurrent fault is removed, the converter will immediately recover.
- (13) Do not exceed maximum power specifications when adjusting the output trim.
- (14) At zero output current, the output may contain low frequency components which exceed the ripple specification. The output may be operated indefinitely with no load.
- (15) Input Fusing: To ensure reverse input protection with full output load, always connect an external input fast-blow fuse in series with the + V_{IN} input. Use approximately twice the full input current rating with nominal input voltage.
- (16) "Hiccup" overcurrent operation repeatedly attempts to restart the converter with a brief, full-current output. If the overcurrent condition still exists, the restart current will be removed and then tried again. This short current pulse prevents overheating and damaging the converter. Once the fault is removed, the converter immediately recovers normal operation.
- (17) Normally, the Sense lines are connected at the remote load to compensate for IR voltage drops in the power wiring and to improve dynamic response. If Sense is not used, each Sense pin should be connected at the converter to its respective Vout pin.

Product Adaptations

Murata Power Solutions offers several variations of our core product family. These products are available under scheduled quantity orders and may also include separate manufacturing documentation from a mutually agreeable Product Specification. Since these product adaptations largely share a common parts list and similar specifications and test methods with their root products, they are provided at excellent costs and delivery. Please contact Murata Power Solutions for details.

As of this date, the following products are available:

UCQ-1.2/30-D48NHL2-Y

UCQ-1.8/30-D48NHL2-Y

UCQ-1.8/40-D48NHL2-Y

UCQ-2.5/30-D48NHL2-Y

UCQ-2.5/40-D48NHL2-Y

UCQ-5/20-D48NHL2-Y

UCQ-12/8.3-D48NHL2-Y

These models are all negative On/Off logic, no baseplate, conformal coating added, 3.68mm pin length, and RoHS-5 hazardous substance compliance (with lead).

UCQ-3.3/30-D48NHL2-Y

UCQ-3.3/40-D48NHL2-Y

These models are all negative On/Off logic, baseplate installed, conformal coating added, 3.68mm pin length, and RoHS-5 hazardous substance compliance (with lead).

Absolute Maximum Ratings		
Input Voltage	24V Models	48V Models
Continuous	0 to +36 Volts	0 to +75 Volts
Transient (100msec)	+50 Volts	+100 Volts
On/Off Control	0V min. to +13.5V max.	
Input Reverse Polarity Protection	See Fuse section	
Output Current	Current-limited. Devices can withstand sustained short circuit without damage.	
Operating Temperature	-40 to +100°C (with derating)	
Storage Temperature	-55 to +125°C	

These are stress ratings. Exposure of devices to greater than any of these conditions may adversely affect long-term reliability. Proper operation under conditions other than those listed in the Performance/Functional Specifications Table is not implied, nor recommended.

TYPICAL PERFORMANCE CURVES

UCQ-1.2/30-D48 Efficiency vs Line Voltage and Load Current @25° C

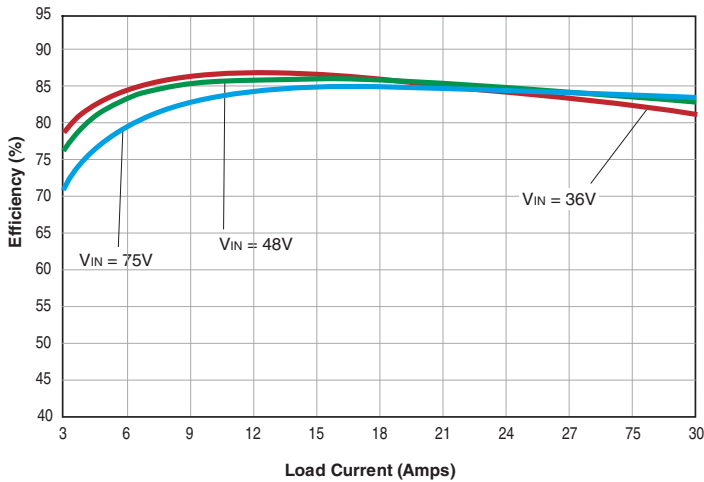

UCQ-1.2/30-D48 Maximum Current Temperature Derating

No baseplate, $V_{IN} = 48V$ (at sea level), longitudinal airflow

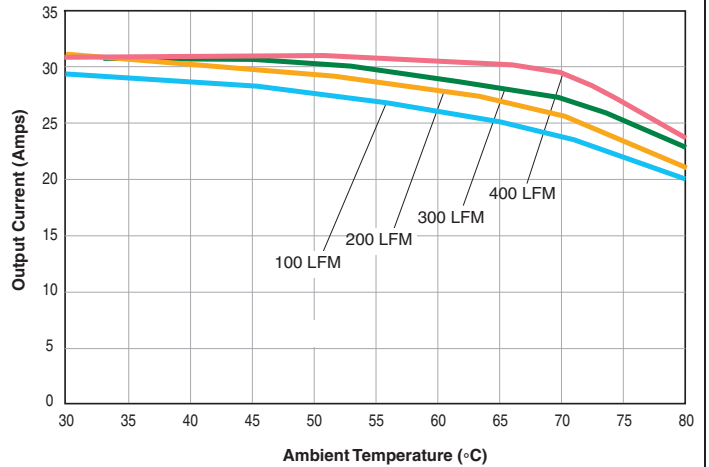

UCQ-1.5/25-D48 Efficiency vs Line Voltage and Load Current @25° C

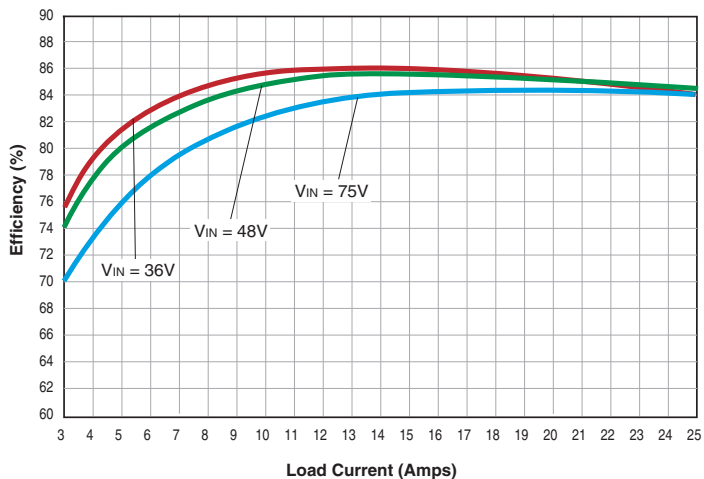

UCQ-1.5/25-D48 Maximum Current Temperature Derating

No baseplate, $V_{IN} = 48V$ (at sea level), longitudinal airflow

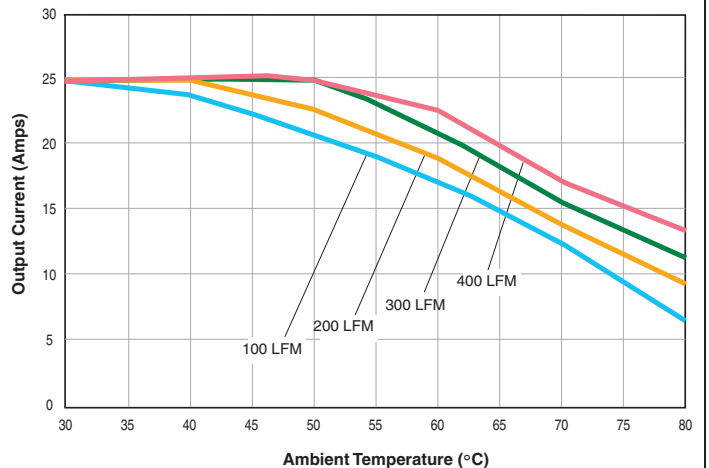

UCQ-1.8/30-D48 Efficiency vs Line Voltage and Load Current @25° C

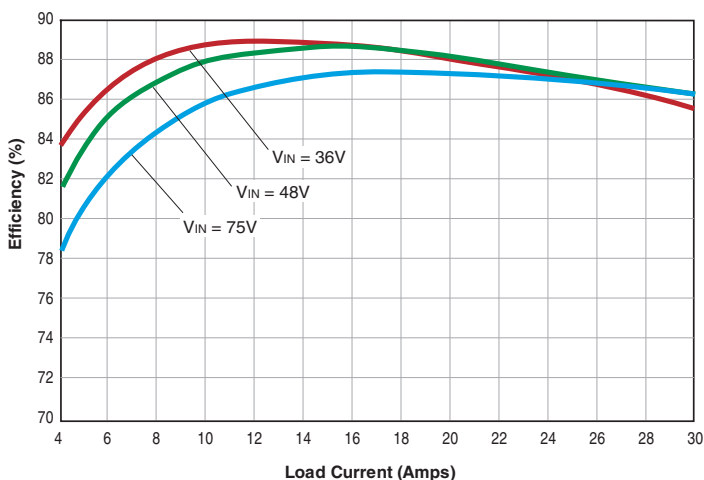

UCQ-1.8/30-D48 Maximum Current Temperature Derating

No baseplate, $V_{IN} = 48V$ (at sea level), longitudinal airflow

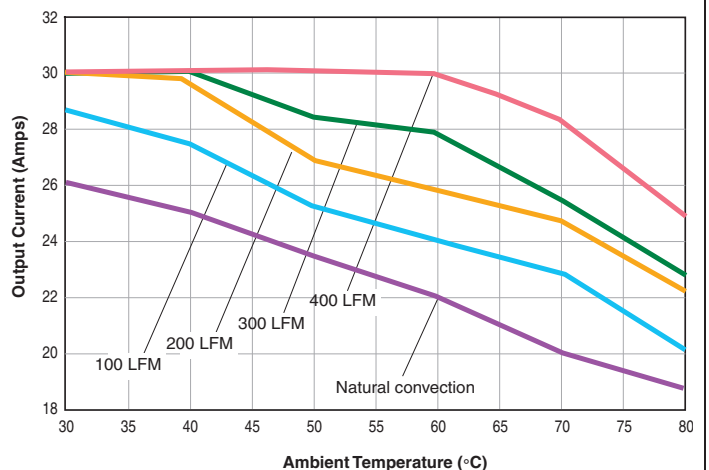

TYPICAL PERFORMANCE CURVES

UCQ-1.8/40-D48 Efficiency and Power Dissipation @25° C

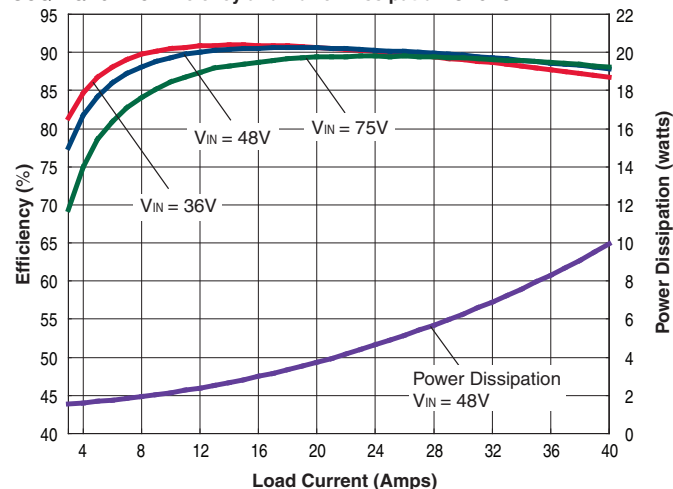

UCQ-1.8/40-D48 Maximum Current Temperature Derating at Sea Level
(VIN = 48V, no baseplate, airflow is from Vin to Vout)

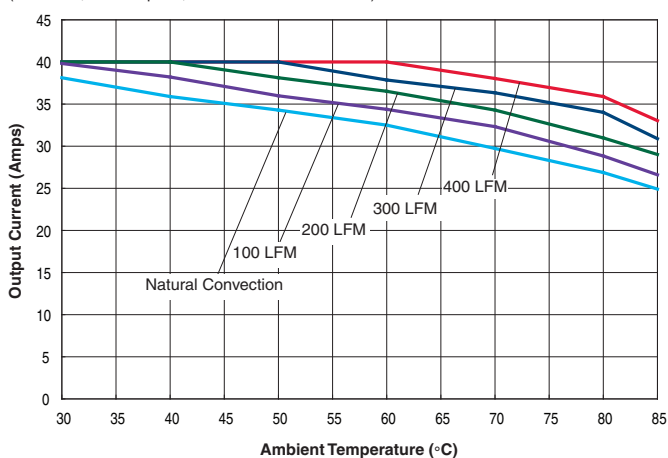

UCQ-2.5/30-D48 Efficiency vs Line Voltage and Load Current @25° C

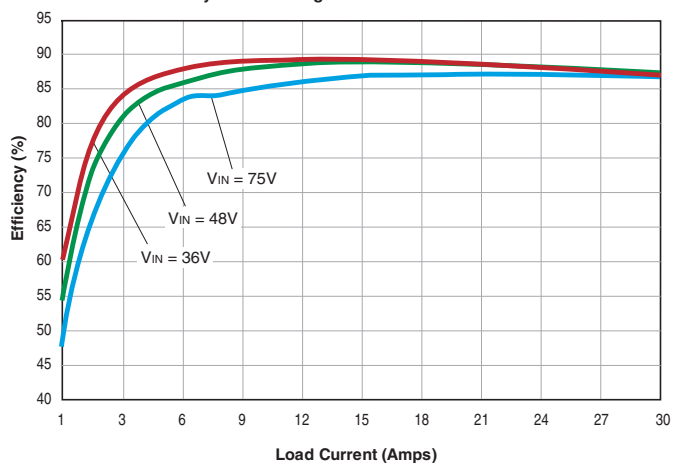

UCQ-2.5/30-D48 Maximum Current Temperature Derating
No baseplate, VIN = 24V (at sea level)

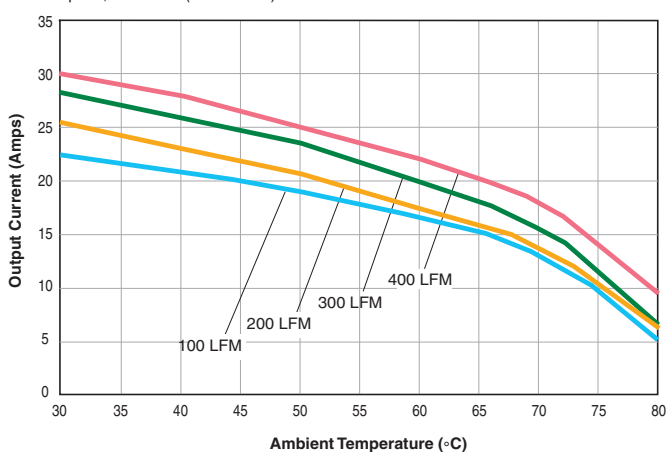

UCQ-2.5/40-D24 Efficiency vs Line Voltage and Load Current @25° C

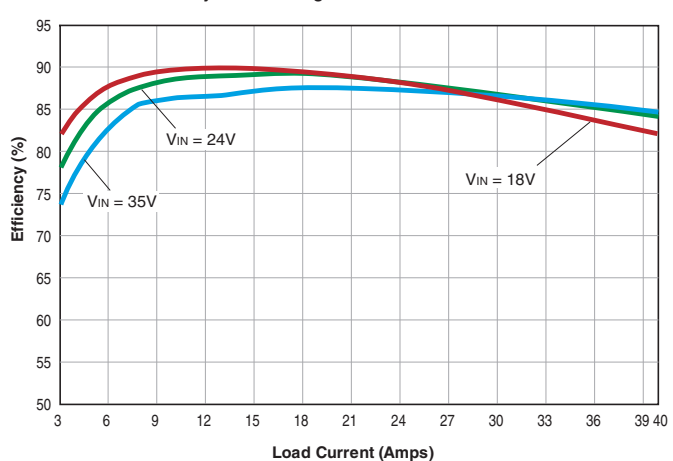

UCQ-2.5/40-D24 Maximum Current Temperature Derating
No baseplate, VIN = 24V (at sea level)

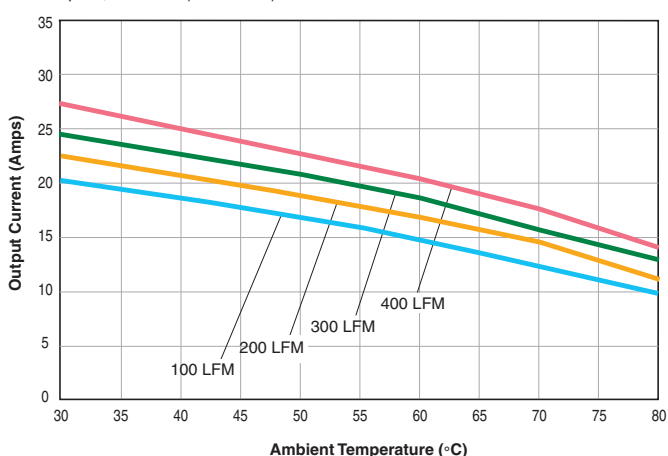

TYPICAL PERFORMANCE CURVES

UCQ-3.3/20-D48 Efficiency vs Line Voltage and Load Current @25°C

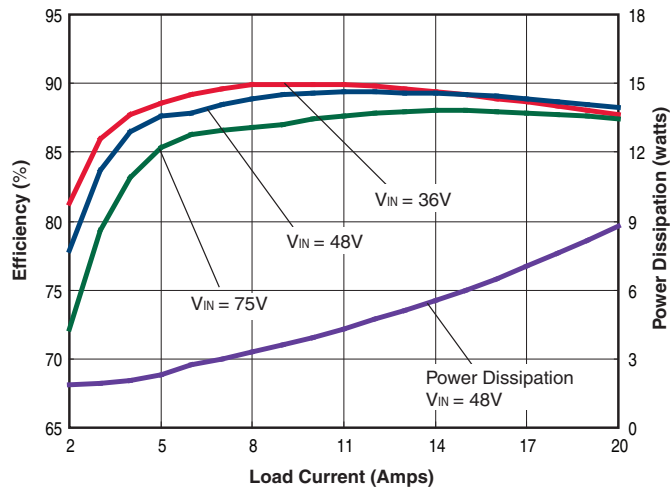

UCQ-3.3/20-D48 Maximum Current Temperature Derating at Sea Level
($V_{IN} = 48V$, longitudinal airflow, no baseplate)

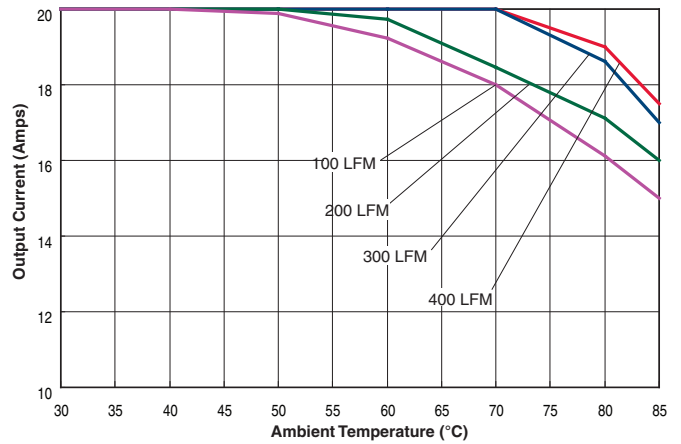

UCQ-3.3/30-D48 Efficiency vs Line Voltage and Load Current @25°C

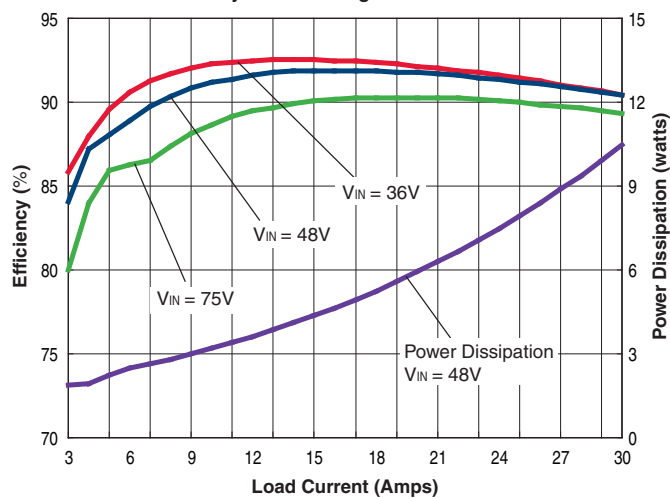

UCQ-3.3/30-D48 Maximum Current Temperature Derating at Sea Level
($V_{IN} = 48V$, no baseplate, airflow is from V_{in} to V_{out})

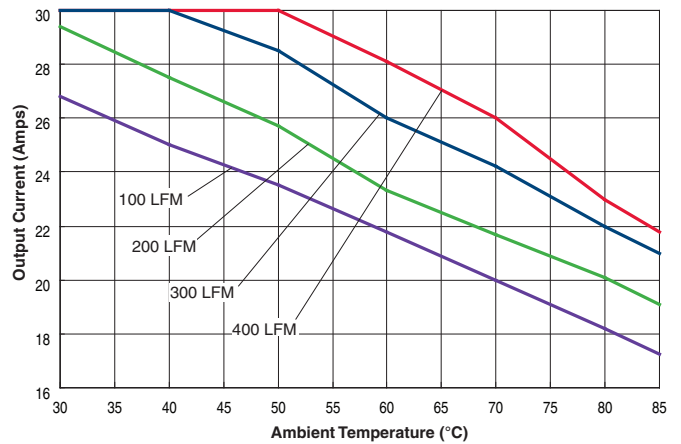

TYPICAL PERFORMANCE CURVES

UCQ-3.3/35-D24 Efficiency vs Line Voltage and Load Current @25° C

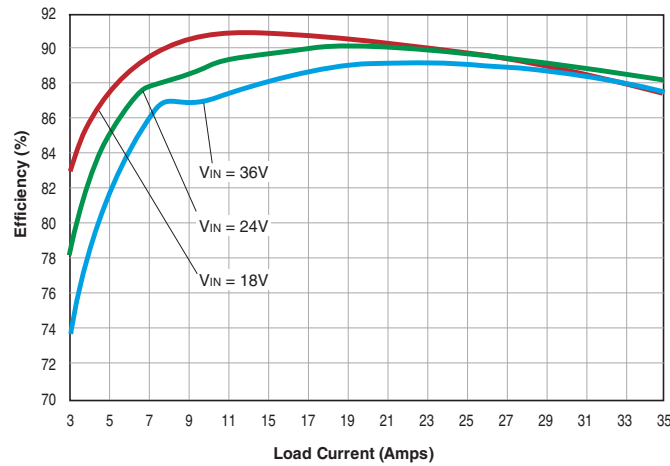

UCQ-3.3/35-D24 Maximum Current Temperature Derating at Sea Level
(VIN = 24V, with baseplate, airflow is from -VIN to +VIN)

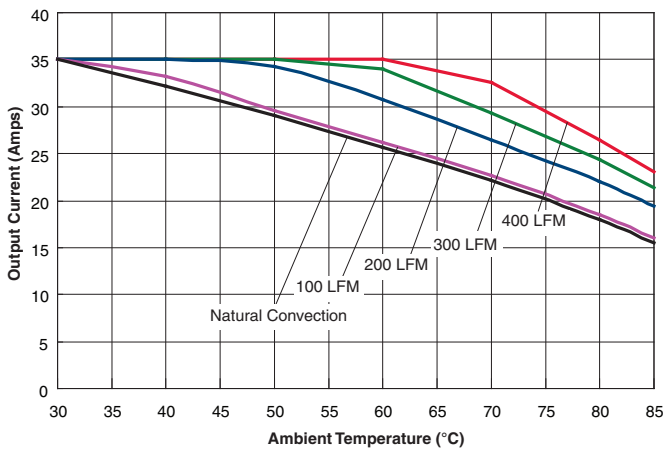

UCQ-3.3/35-D24 Maximum Current Temperature Derating at Sea Level
(VIN = 24V, no baseplate, airflow is from -VIN to +VIN)

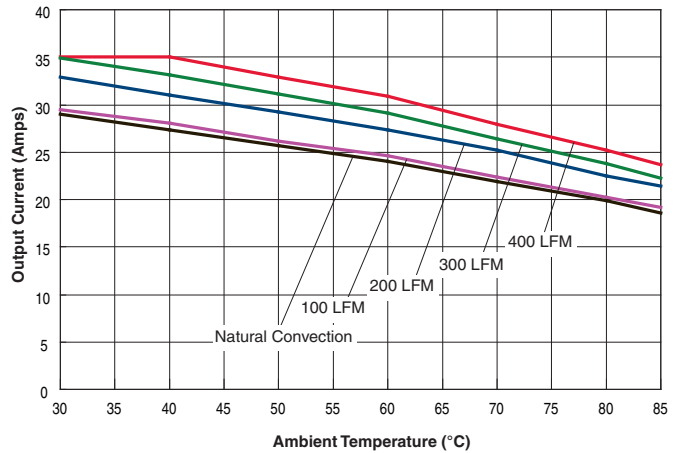

TYPICAL PERFORMANCE CURVES

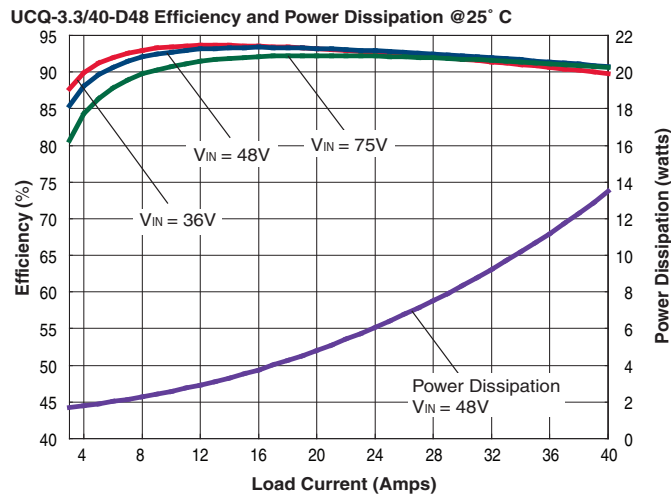

UCQ-3.3/40-D48 Maximum Current Temperature Derating at Sea Level
(VIN = 48V, with baseplate, transverse airflow)

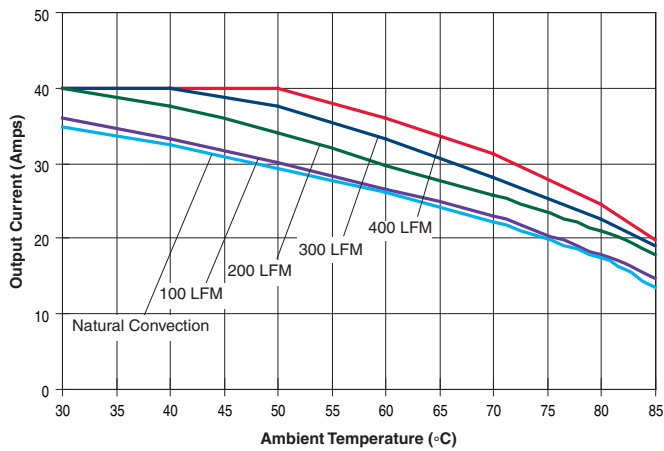

UCQ-3.3/40-D48 Maximum Current Temperature Derating at Sea Level
(VIN = 48V, no baseplate, transverse airflow)

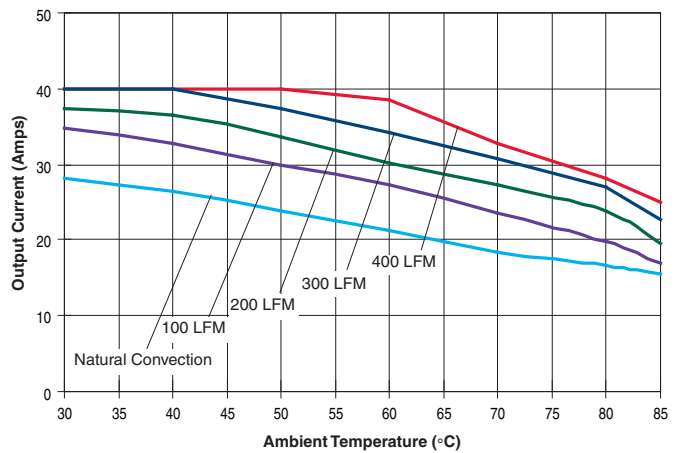

TYPICAL PERFORMANCE CURVES

UCQ-5/20-D24 Efficiency and Power Dissipation @25°C

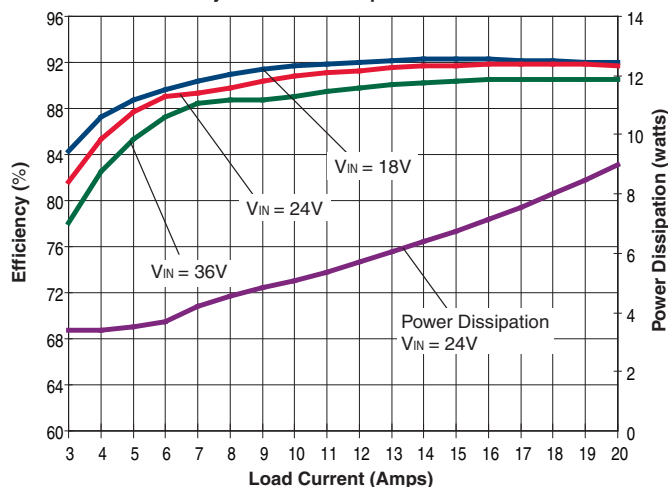

UCQ-5/20-D24 Maximum Current Temperature Derating at Sea Level
($V_{IN} = 24V$, no baseplate, airflow is from -Vin to +Vin)

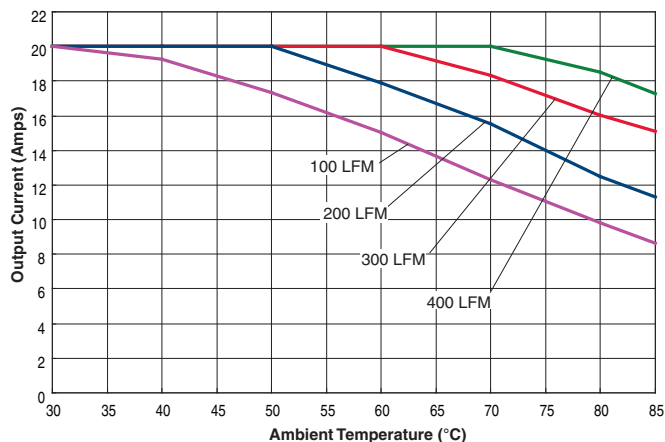

UCQ-5/20-D24 Maximum Current Temperature Derating at Sea Level
($V_{IN} = 24V$, with baseplate, airflow is from -Vin to +Vin)

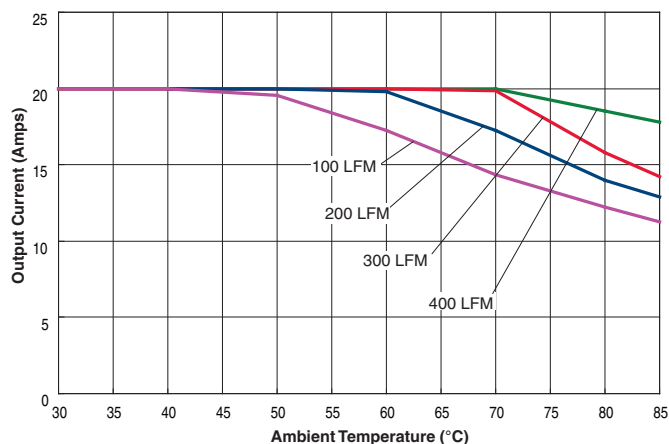

UCQ-5/20-D48 Efficiency vs Line Voltage and Load Current @25°C

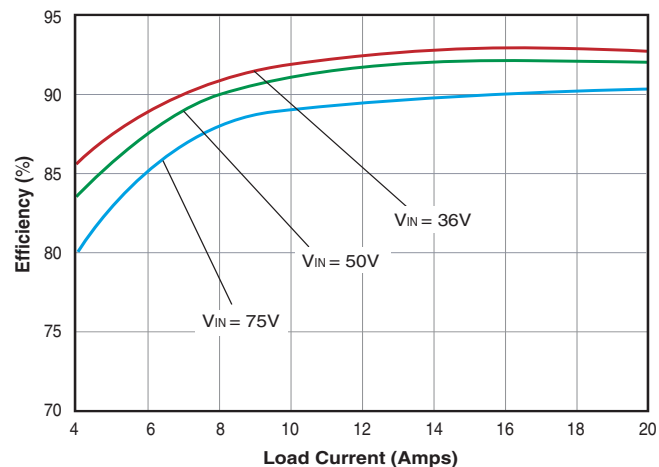

UCQ-5/20-D48 Maximum Current Temperature Derating at Sea Level
($V_{IN} = 48V$, no baseplate, airflow is from -Vin to +Vin)

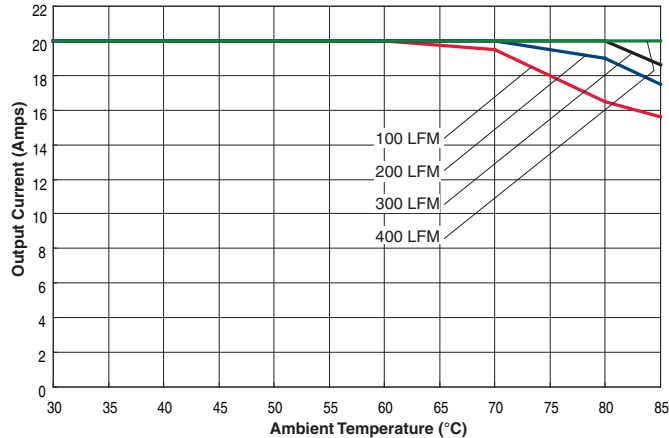

TYPICAL PERFORMANCE CURVES

UCQ-5/25-D48 Efficiency and Power Dissipation @25° C

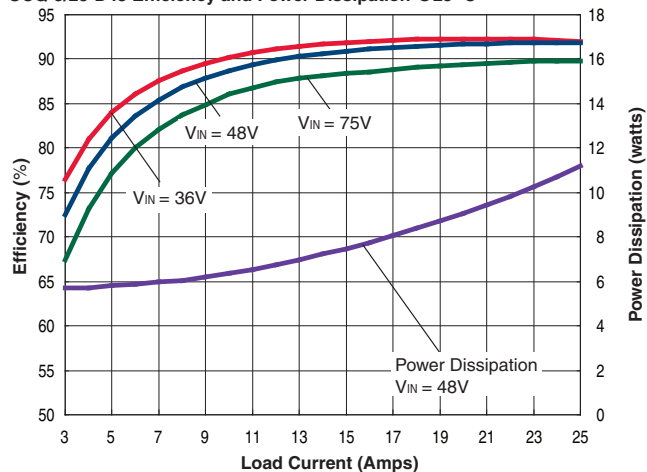

UCQ-5/25-D48 Maximum Current Temperature Derating at Sea Level
($V_{IN} = 48V$, no baseplate, airflow is from V_{in} to V_{out})

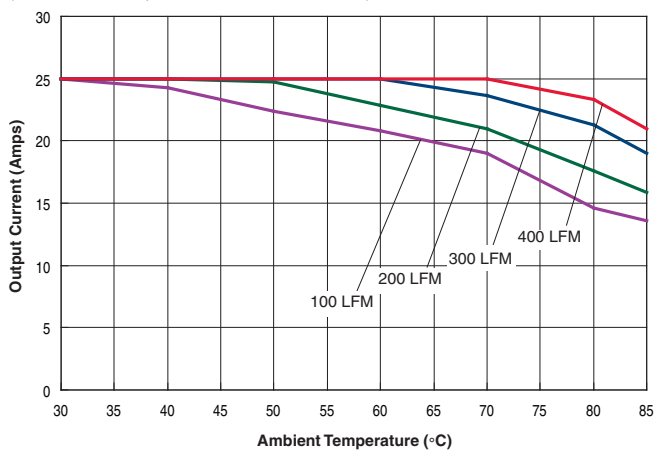

UCQ-12/8.3-D48 Efficiency and Power Dissipation @25° C

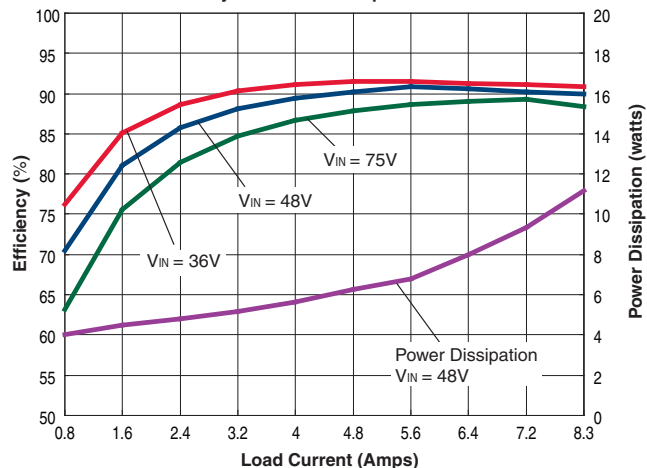

UCQ-12/8.3-D48 Maximum Current Temperature Derating at Sea Level
($V_{IN} = 48V$, no baseplate, airflow is from V_{in} to V_{out})

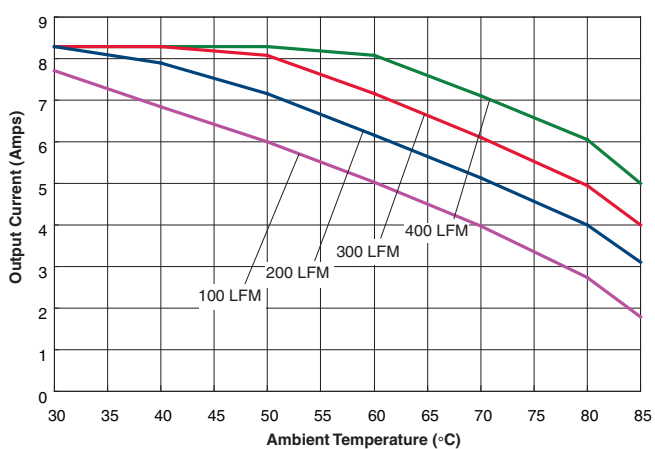

UCQ-12/8.3-D48 Maximum Current Temperature Derating at Sea Level
($V_{IN} = 48V$, with baseplate, longitudinal airflow)

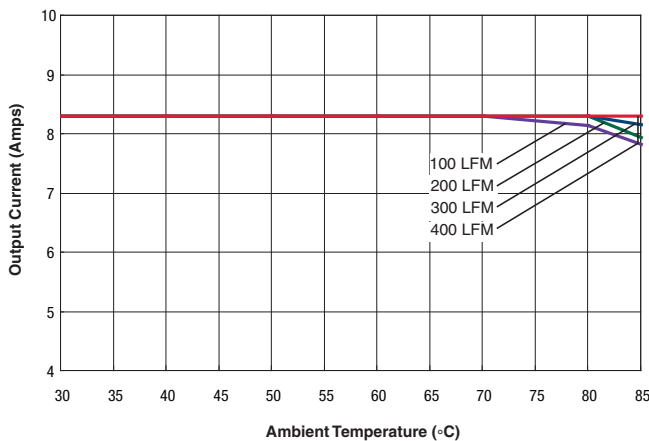

TYPICAL PERFORMANCE CURVES

UCQ-15/6.7-D48 Efficiency and Power Dissipation @Ta = 25° C

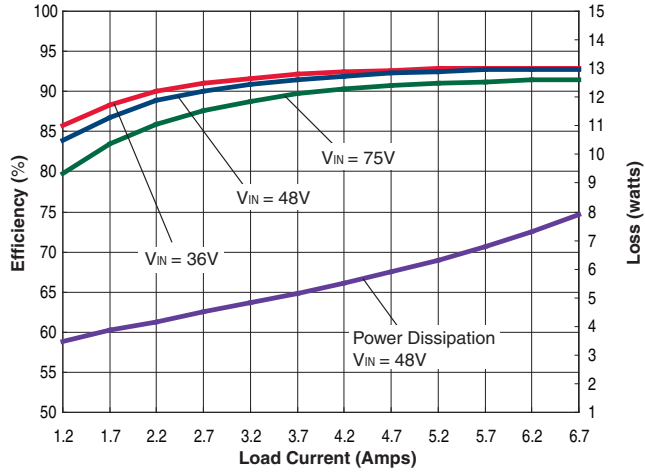

UCQ-15/6.7-D48 Maximum Current Temperature Derating at Sea Level
(VIN = 48V, no baseplate, airflow is from Vin to Vout)

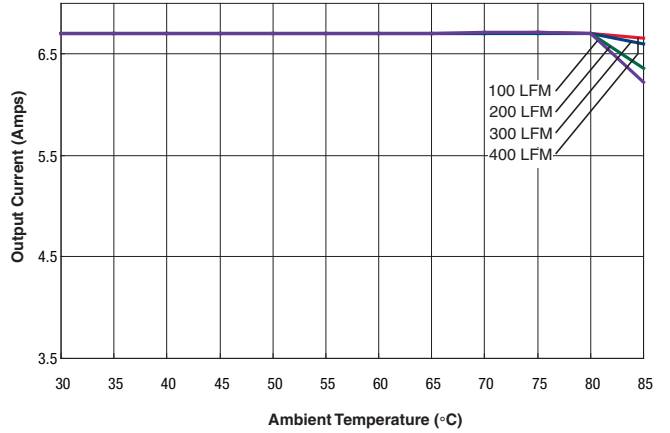

UCQ-15/6.7-D48 Maximum Current Temperature Derating at Sea Level
(VIN = 48V, with baseplate, airflow is from Vin to Vout)

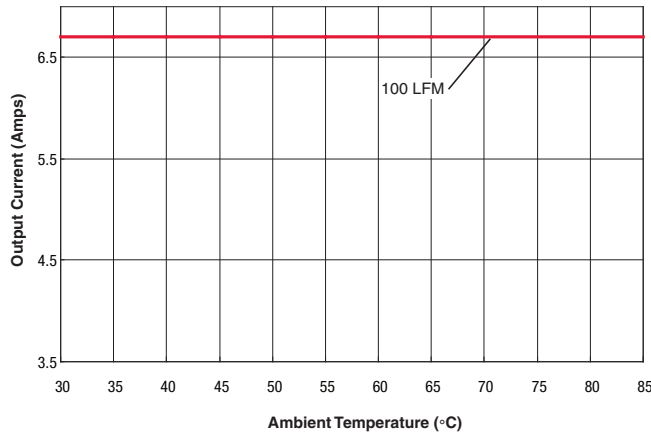

TYPICAL PERFORMANCE CURVES

UCQ-3.3/30-D48 Output Transient Response
($V_{IN} = 48V$, resistive load step 75% to 50%)

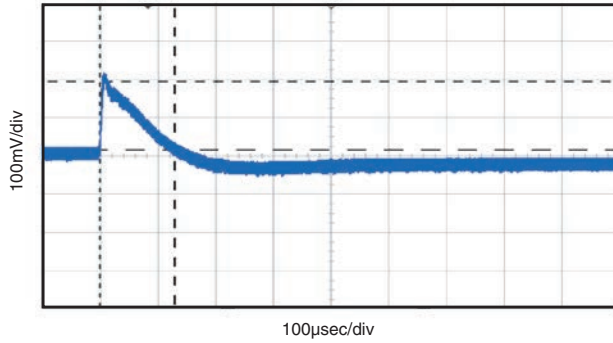

UCQ-3.3/30-D48 Output Transient Response
($V_{IN} = 48V$, resistive load step 50% to 75%)

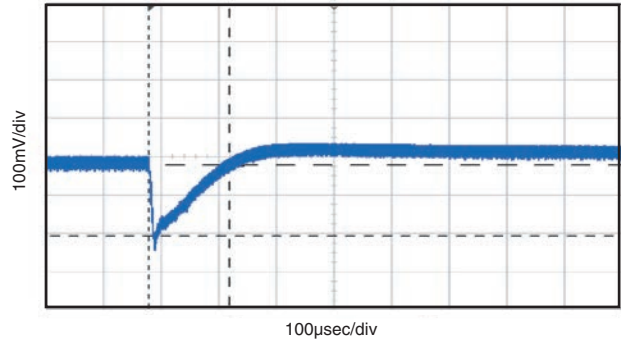

UCQ-3.3/30-D48 Enable On/Off
($V_{IN} = 48V$, $I_{OUT} = 30A$)

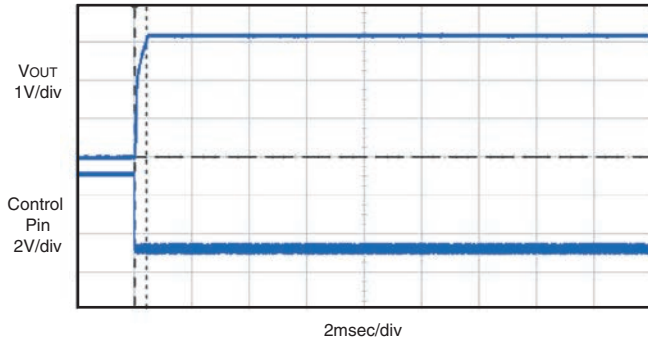

UCQ-3.3/30-D48 Ripple and Noise
($V_{IN} = 48V$, $I_{OUT} = 30A$ resistive, output caps 1µF ceramic || 10µF tantalum)

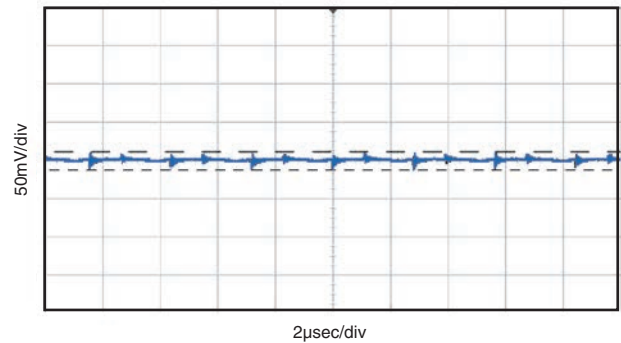

MECHANICAL SPECIFICATIONS

UCQ with Optional Baseplate

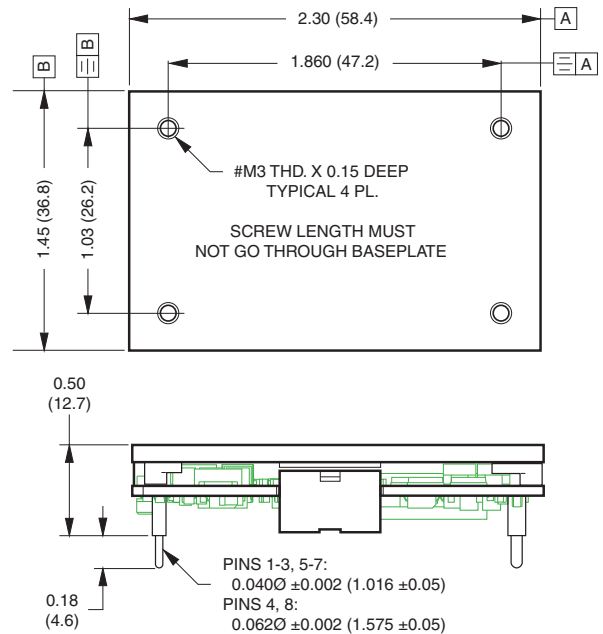
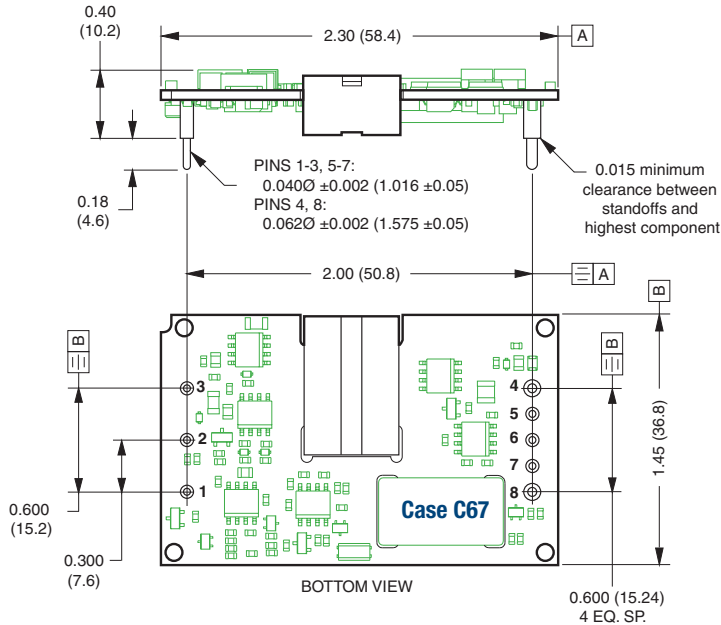

Dimensions are in inches (mm shown for ref. only).

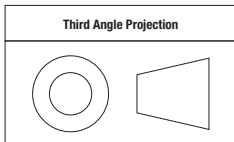

Tolerances (unless otherwise specified):
.XX ± 0.02 (0.5)
.XXX ± 0.010 (0.25)
Angles ± 2°

Components are shown for reference only.

Component locations may vary between units.

Standard pin length is shown. Please refer to the Part Number Structure for special order pin lengths.

DOSA-Compliant I/O Connections			
Pin	Function P32	Pin	Function P32
1	+Vin	5	-Sense
2	Remote On/Off	6	Trim
3	-Vin	7	+Sense
4	-Vout	8	+Vout

TECHNICAL NOTES

Input Fusing

Certain applications and/or safety agencies may require the installation of fuses at the inputs of power conversion components. Fuses should also be used if the possibility of sustained, non-current-limited, input-voltage polarity reversals exists. For Murata Power Solutions UCQ series DC-DC converters, we recommend the use of a fast blow fuse, installed in the ungrounded input supply line with a typical value about twice the maximum input current, calculated at low line with the converter’s minimum efficiency.

All relevant national and international safety standards and regulations must be observed by the installer. For system safety agency approvals, the converters must be installed in compliance with the requirements of the end-use safety standard, i.e. IEC/EN/UL60950-1.

Input Reverse-Polarity Protection

If the input voltage polarity is accidentally reversed, an internal diode will become forward biased and likely draw excessive current from the power source. If this source is not current limited or the circuit appropriately fused, it could cause permanent damage to the converter.

Input Under-Voltage Shutdown and Start-Up Threshold

Under normal start-up conditions, devices will not begin to regulate properly until the ramping-up input voltage exceeds the Start-Up Threshold Voltage. Once operating, devices will not turn off until the input voltage drops below the Under-Voltage Shutdown limit. Subsequent re-start will not occur until the input is brought back up to the Start-Up Threshold. This built in hysteresis prevents any unstable on/off situations from occurring at a single input voltage.

Start-Up Time

The V_{IN} to V_{OUT} Start-Up Time is the time interval between the point at which the ramping input voltage crosses the Start-Up Threshold and the fully loaded output voltage enters and remains within its specified accuracy band. Actual measured times will vary with input source impedance, external input capacitance, and the slew rate and final value of the input voltage as it appears at the converter. The UCQ Series implements a soft start circuit to limit the duty cycle of its PWM controller at power up, thereby limiting the input inrush current.

The On/Off Control to V_{OUT} start-up time assumes the converter has its nominal input voltage applied but is turned off via the On/Off Control pin. The specification defines the interval between the point at which the converter is turned on (released) and the fully loaded output voltage enters and remains within its specified accuracy band. Similar to the V_{IN} to V_{OUT} start-up, the On/Off Control to V_{OUT} start-up time is also governed by the internal soft start circuitry and external load capacitance. The difference in start up time from V_{IN} to V_{OUT} and from On/Off Control to V_{OUT} is therefore insignificant.

Input Source Impedance

The input of UCQ converters must be driven from a low ac-impedance source. The DC-DC’s performance and stability can be compromised by the use of highly inductive source impedances. The input circuit shown in Figure 2 is a practical solution that can be used to minimize the effects of inductance in the input traces. For optimum performance, components should be mounted close to the DC-DC converter.

I/O Filtering, Input Ripple Current, and Output Noise

All models in the UCQ Series are tested/specified for input reflected ripple current and output noise using the specified external input/output components/circuits and layout as shown in the following two figures. External input capacitors (C_{IN} in Figure 2) serve primarily as energy-storage elements, minimizing line voltage variations caused by transient IR drops in conductors from backplane to the DC-DC. Input caps should be selected for bulk capacitance (at appropriate frequencies), low ESR, and high rms-ripple-current ratings. The switching nature of DC-DC converters requires that dc voltage sources have low ac impedance as highly inductive source impedance can affect system stability. In Figure 2, C_{BUS} and L_{BUS} simulate a typical dc voltage bus. Your specific system configuration may necessitate additional considerations.

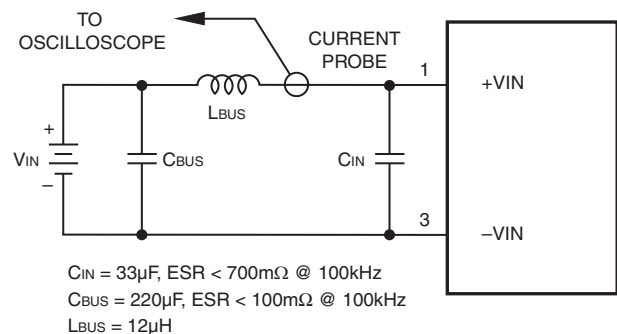

Figure 2. Measuring Input Ripple Current

In critical applications, output ripple/noise (also referred to as periodic and random deviations or PARD) may be reduced below specified limits using filtering techniques, the simplest of which is the installation of additional external output capacitors. They function as true filter elements and should be selected for bulk capacitance, low ESR and appropriate frequency response.

All external capacitors should have appropriate voltage ratings and be located as close to the converter as possible. Temperature variations for all relevant parameters should also be taken carefully into consideration. The most effective combination of external I/O capacitors will be a function of line voltage and source impedance, as well as particular load and layout conditions.

Floating Outputs

Since these are isolated DC-DC converters, their outputs are “floating” with respect to their input. Designers will normally use the –Output (pin 4) as the ground/return of the load circuit. You can however, use the +Output (pin 8) as ground/return to effectively reverse the output polarity.

Minimum Output Loading Requirements

UCQ converters employ a synchronous-rectifier design topology and all models regulate within spec and are stable under no-load to full load conditions. Operation under no-load conditions however might slightly increase the output ripple and noise.

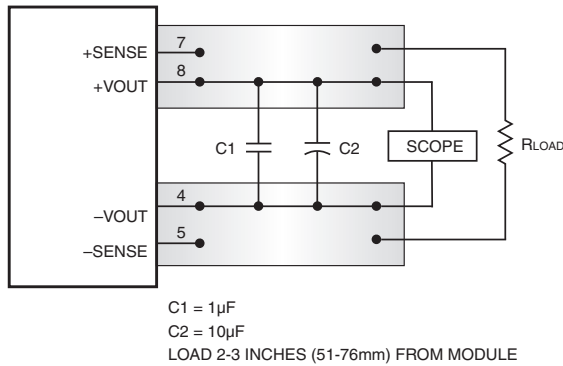

Figure 3. Measuring Output Ripple/Noise (PARD)

Thermal Shutdown

The UCQ converters are equipped with thermal-shutdown circuitry. If environmental conditions cause the temperature of the DC-DC converter to rise above the designed operating temperature, a precision temperature sensor will power down the unit. When the internal temperature decreases below the threshold of the temperature sensor, the unit will self start. See Performance/Functional Specifications.

Output Over-Voltage Protection

The UCQ output voltage is monitored for an over-voltage condition using a comparator. The signal is optically coupled to the primary side and if the output voltage rises to a level which could be damaging to the load, the sensing circuitry will power down the PWM controller causing the output voltage to decrease. Following a time-out period the PWM will restart, causing the output voltage to ramp to its appropriate value. If the fault condition persists, and the output voltage again climbs to excessive levels, the over-voltage circuitry will initiate another shutdown cycle. This on/off cycling is referred to as “hiccup” mode.

Current Limiting

As soon as the output current increases to approximately 130% of its rated value, the DC-DC converter will go into a current-limiting mode. In this condition, the output voltage will decrease proportionately with increases in output current, thereby maintaining somewhat constant power dissipation. This is commonly referred to as power limiting. Current limit inception is defined as the point at which the full-power output voltage falls below the specified tolerance. See Performance/Functional Specifications. If the load current, being drawn from the converter, is significant enough, the unit will go into a short circuit condition as described below.

Short Circuit Condition

When a converter is in current-limit mode, the output voltage will drop as the output current demand increases. If the output voltage drops too low, the magnetically coupled voltage used to develop primary side voltages will also drop, thereby shutting down the PWM controller. Following a time-out period, the PWM will restart causing the output voltage to begin ramping to their appropriate value. If the short-circuit condition persists, another shutdown cycle will be initiated. This on/off cycling is referred to as “hiccup” mode. The hiccup cycling reduces the average output current, thereby preventing internal temperatures from rising to excessive levels. The UCQ Series is capable of enduring an indefinite short circuit output condition.

Remote Sense

Note: The Sense and V_{OUT} lines are internally connected through low-value resistors. Nevertheless, if the sense function is not used for remote regulation the user should connect the +Sense to +V_{OUT} and –Sense to –V_{OUT} at the DC-DC converter pins. UCQ series converters employ a sense feature to provide point of use regulation, thereby overcoming moderate IR drops in PCB conductors or cabling. The remote sense lines carry very little current and therefore require minimal cross-sectional-area conductors. The sense lines, which are capacitively coupled to their respective output lines, are used by the feedback control-loop to regulate the output. As such, they are not low impedance points and must be treated with care in layouts and cabling. Sense lines on a PCB should be run adjacent to dc signals, preferably ground.

$$[V_{OUT(+)} - V_{OUT(-)}] - [Sense(+)-Sense(-)] \leq 10\%V_{OUT}$$

In cables and discrete wiring applications, twisted pair or other techniques should be used. Output over-voltage protection is monitored at the output voltage pin, not the Sense pin. Therefore, excessive voltage differences between V_{OUT} and Sense in conjunction with trim adjustment of the output voltage can cause the over-voltage protection circuitry to activate (see Performance Specifications for over-voltage limits). Power derating is based on maximum output current and voltage at the converter’s output pins. Use of trim and sense functions can cause output voltages to increase, thereby increasing output power beyond the converter’s specified rating, or cause output voltages to climb into the output over-voltage region. Therefore, the designer must ensure:

$$(V_{OUT \text{ at pins}}) \times (I_{OUT}) \leq \text{rated output power}$$

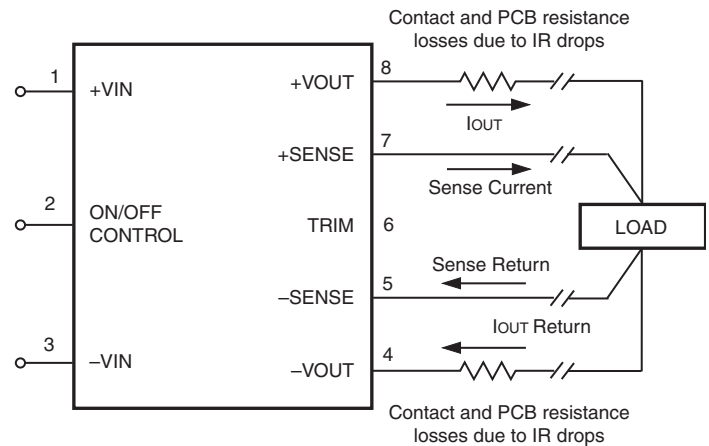

Figure 4. Remote Sense Circuit Configuration

Trimming Output Voltage

UCQ converters have a trim capability (pin 6) that enables users to adjust the output voltage (refer to the trim equations and trim graphs that follow). Adjustments to the output voltage can be accomplished via a trim pot (Figure 5) or a single fixed resistor as shown in Figures 6 and 7. A single fixed resistor can increase or decrease the output voltage depending on its connection. Resistors should be located close to the converter and have TCR’s less than 100ppm/°C to minimize sensitivity to changes in temperature. If the trim function is not used, leave the trim pin open.

A single resistor connected from the Trim pin (pin 6) to the +Sense (pin 7) will increase the output voltage. A resistor connected from the Trim Pin (pin 6) to the -Sense (pin 5) will decrease the output voltage.

Trim adjustments greater than the specified range can have an adverse affect on the converter's performance and are not recommended. Excessive voltage differences between V_{OUT} and Sense, in conjunction with trim adjustment of the output voltage, can cause the over-voltage protection circuitry to activate (see Performance Specifications for over-voltage limits). Temperature/power derating is based on maximum output current and voltage at the converter's output pins. Use of the trim and sense functions can cause output voltages to increase, thereby increasing output power beyond the converter's specified rating, or cause output voltages to climb into the output over-voltage region. Therefore:

$$(V_{out \text{ at pins}}) \times (I_{out}) \geq \text{rated output power}$$

The Trim pin (pin 6) is a relatively high impedance node that can be susceptible to noise pickup when connected to long conductors in noisy environments. In such cases, a 0.22 μ F capacitor between trim and -Vout can be added to reduce this long lead effect.

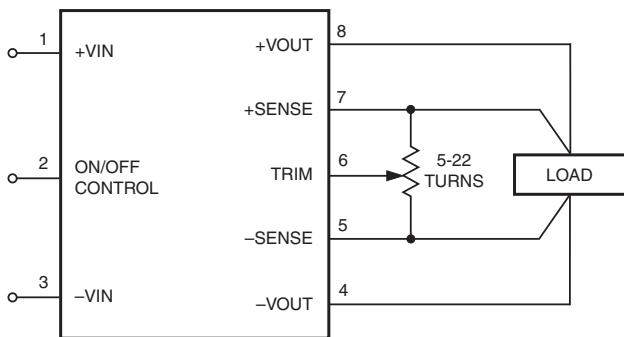

Figure 5. Trim Connections Using A Trimpot

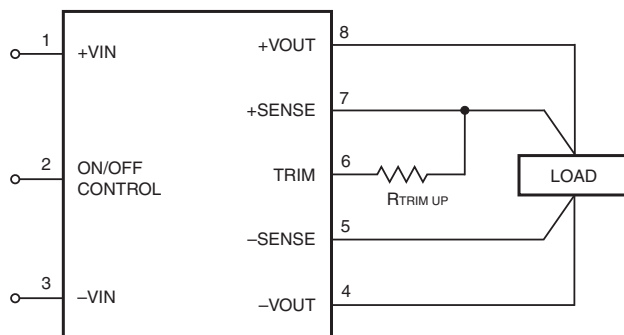

Figure 6. Trim Connections To Increase Output Voltages Using Fixed Resistors

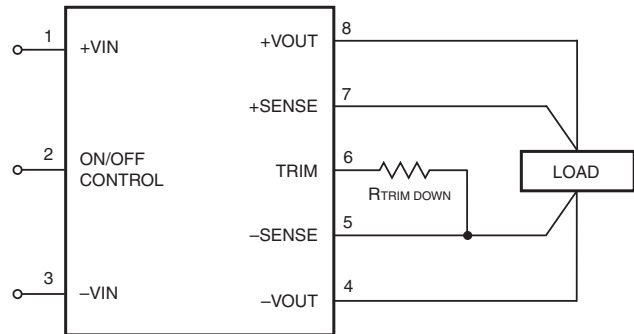

Figure 7. Trim Connections To Decrease Output Voltages Using Fixed Resistors

Trim Equations

(For all models **except** the UCQ-1.2/40-D24 and -1.2/30-D48)

Trim Down

Connect trim resistor between trim pin and -Sense

$$R_{TrimDn} (k \Omega) = \frac{5.11}{\Delta} - 10.22$$

Trim Up

Connect trim resistor between trim pin and +Sense

$$R_{TrimUp} (k \Omega) = \frac{5.11 \times V_{NOM} \times (1+\Delta)}{1.225 \times \Delta} - \frac{5.11}{\Delta} - 10.22$$

Where,

$$\Delta = | (V_{NOM} - V_{OUT}) / V_{NOM} |$$

V_{NOM} is the nominal, untrimmed output voltage.

V_{OUT} is the desired new output voltage.

Do not exceed the specified trim range or maximum power ratings when adjusting trim. Use 1% precision resistors mounted close to the converter on short leads.

(For the UCQ-1.2/40-D24 and -1.2/30-D48)

Trim Down

Connect trim resistor between trim pin and -Sense

$$R_{TrimDn} (k \Omega) = \frac{5.11}{2\Delta - 2}$$

Trim Up

Connect trim resistor between trim pin and +Sense

$$R_{TrimUp} (k \Omega) = \frac{5.11 \times V_{NOM} \times (1+\Delta)}{1.225 \times \Delta}$$

On/Off Control

The input-side, remote On/Off Control function (pin 2) can be ordered to operate with either logic type:

Positive (no suffix) logic models are enabled when pin 2 is left open (or is pulled high, applying +3.5V to +13.5V with respect to -Input, pin 1) as per Figure 8. Positive-logic devices are disabled when pin 2 is pulled low (0 to 0.8V with respect to -Input).

Negative ("N" suffix) logic devices are off when pin 2 is left open (or pulled high, applying +3.5V to +13.5V), and on when pin 2 is pulled low (0 to 1V) with respect to -Input as shown in Figure 9.

Dynamic control of the remote on/off function is best accomplished with a mechanical relay or an open-collector/open-drain drive circuit (optically isolated if appropriate). The drive circuit should be able to sink appropriate current (see Performance Specifications) when activated and withstand appropriate voltage when deactivated. Applying an external voltage to pin 2 when no input power is applied to the converter can cause permanent damage to the converter.

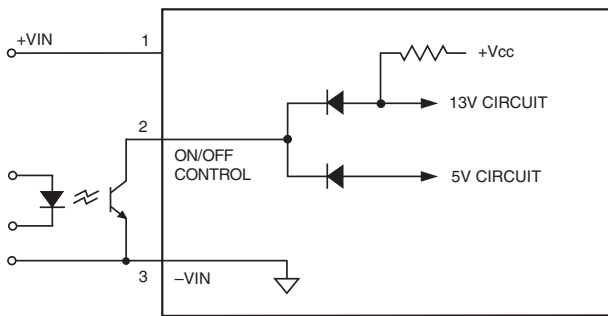

Figure 8. Driving the Negative Logic On/Off Control Pin (simplified circuit)

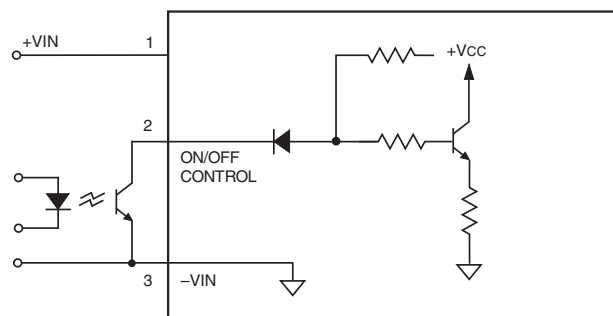

Figure 9. Driving the Negative Logic On/Off Control Pin (simplified circuit)

Soldering Guidelines

Murata Power Solutions recommends the specifications below when installing these converters. These specifications vary depending on the solder type. Exceeding these specifications may cause damage to the product. Your production environment may differ; therefore please thoroughly review these guidelines with your process engineers.

Wave Solder Operations for through-hole mounted products (THMT)			
For Sn/Ag/Cu based solders:		For Sn/Pb based solders:	
Maximum Preheat Temperature	115° C.	Maximum Preheat Temperature	105° C.
Maximum Pot Temperature	270° C.	Maximum Pot Temperature	250° C.
Maximum Solder Dwell Time	7 seconds	Maximum Solder Dwell Time	6 seconds

Murata Power Solutions, Inc.
11 Cabot Boulevard, Mansfield, MA 02048-1151 U.S.A.
ISO 9001 and 14001 REGISTERED



This product is subject to the following [operating requirements](#) and the [Life and Safety Critical Application Sales Policy](#):
Refer to: <http://www.murata-ps.com/requirements/>

Murata Power Solutions, Inc. makes no representation that the use of its products in the circuits described herein, or the use of other technical information contained herein, will not infringe upon existing or future patent rights. The descriptions contained herein do not imply the granting of licenses to make, use, or sell equipment constructed in accordance therewith. Specifications are subject to change without notice. © 2016 Murata Power Solutions, Inc.