

Alle Rechte vorbehalten/ All rights reserved

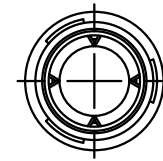

SECTION A-A:

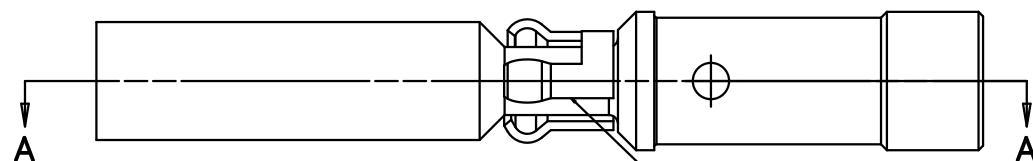
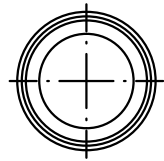
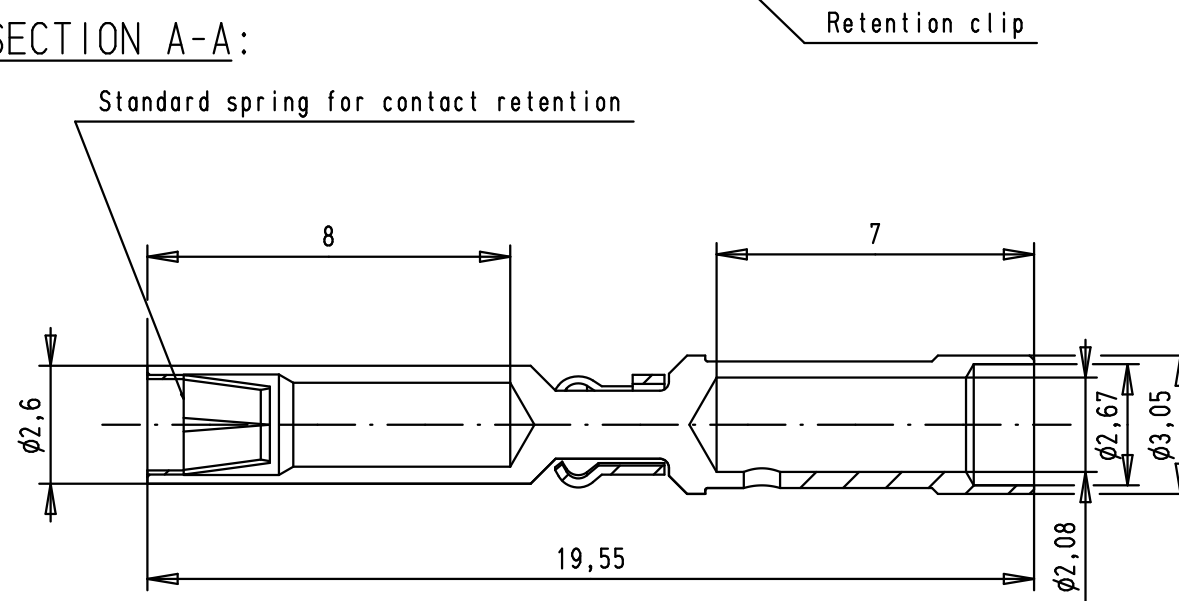

STRIPPING LENGTH: 6mm

MATERIAL:



- contact: brass
- standard spring: CuBe
- retention clip: stainless steel

PLATING:

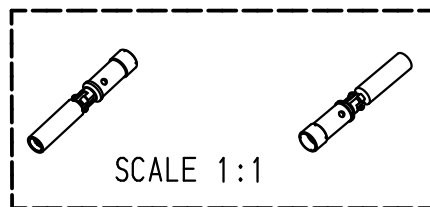
- contact: Ni/Sn
- standard spring: Ni/Au
- retention clip: raw material

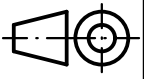

SCALE 1:1

			Det.	Name	 All Dim. in mm Orig. Size DIN A 3	FEMALE POWER CONTACT CRIMP AWG 16-14	Maßstab/ Scale 6:1
		Detail.	22/08/08	AB			
		Insp.	10/05/11	JMV			
		Stand.					
36242	09/05/11	AB	HARTING EURL F-95972 Paris			TB 09 46 500 0402	Blatt/ Page 1 / 1
35287	22/08/08	AB					
Mod.	Det.	Name					