

LOC	DIST	REVISIONS				
P	LTR	DESCRIPTION	DATE	DWN	APVD	
J	-	E REVISED	14JUN2011	M.M	N.Y	

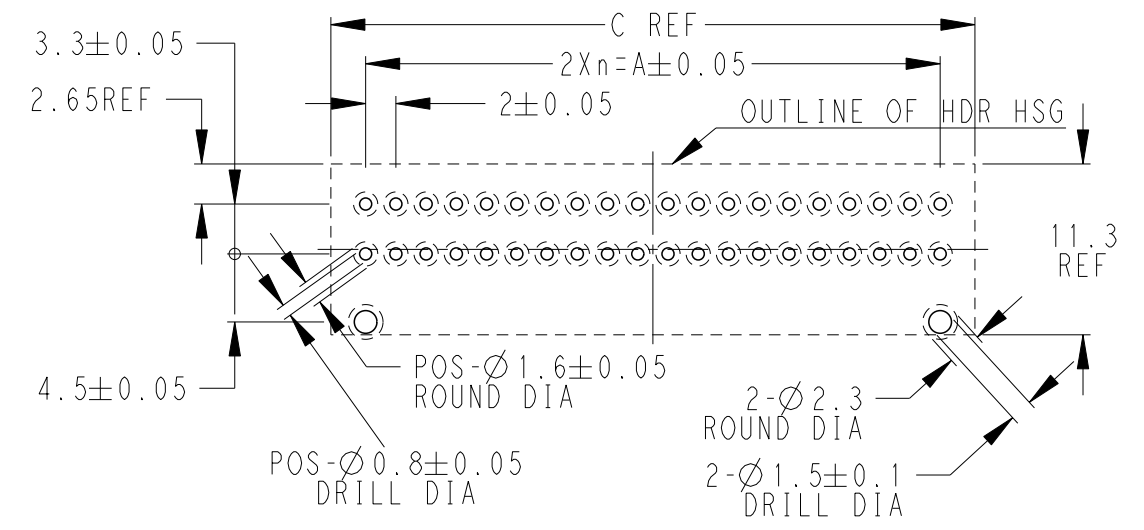

RECOMMEND PC BOARD HOLE PATTERN
 : CONNECTOR MOUNT SIDE (NOT ACCUMULATE TOLERANCE)
 PC BOARD THICKNESS : 1.0~1.6±0.1

- 1-1871056-□ : NATURAL (X-KEY)
- 3-1871056-□ : YELLOW (X-KEY)
- 5-1871056-□ : RED (X-KEY)

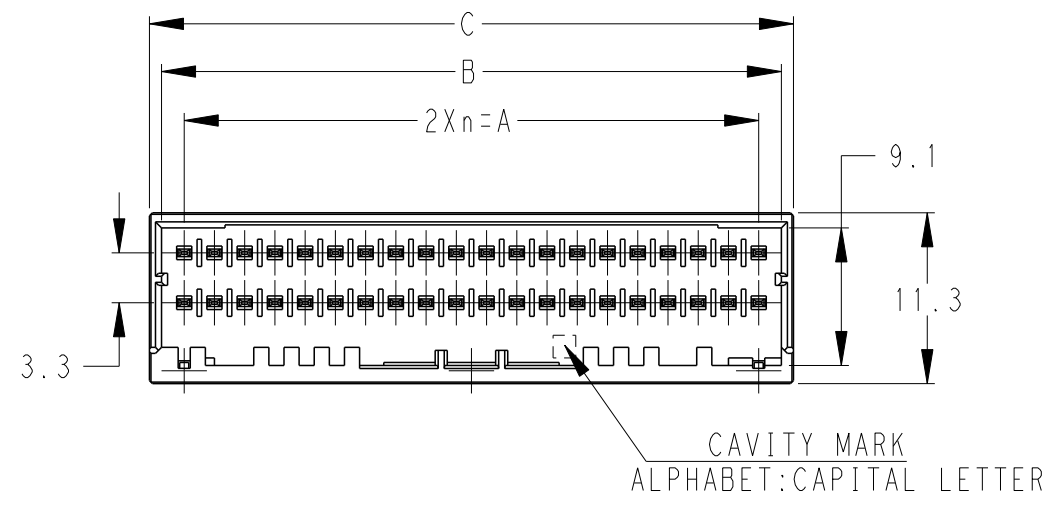
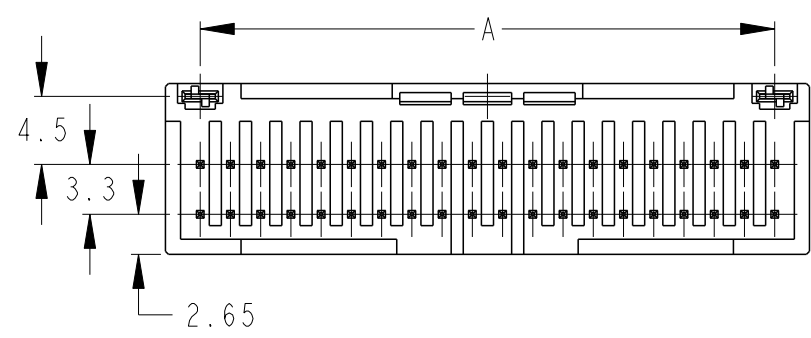
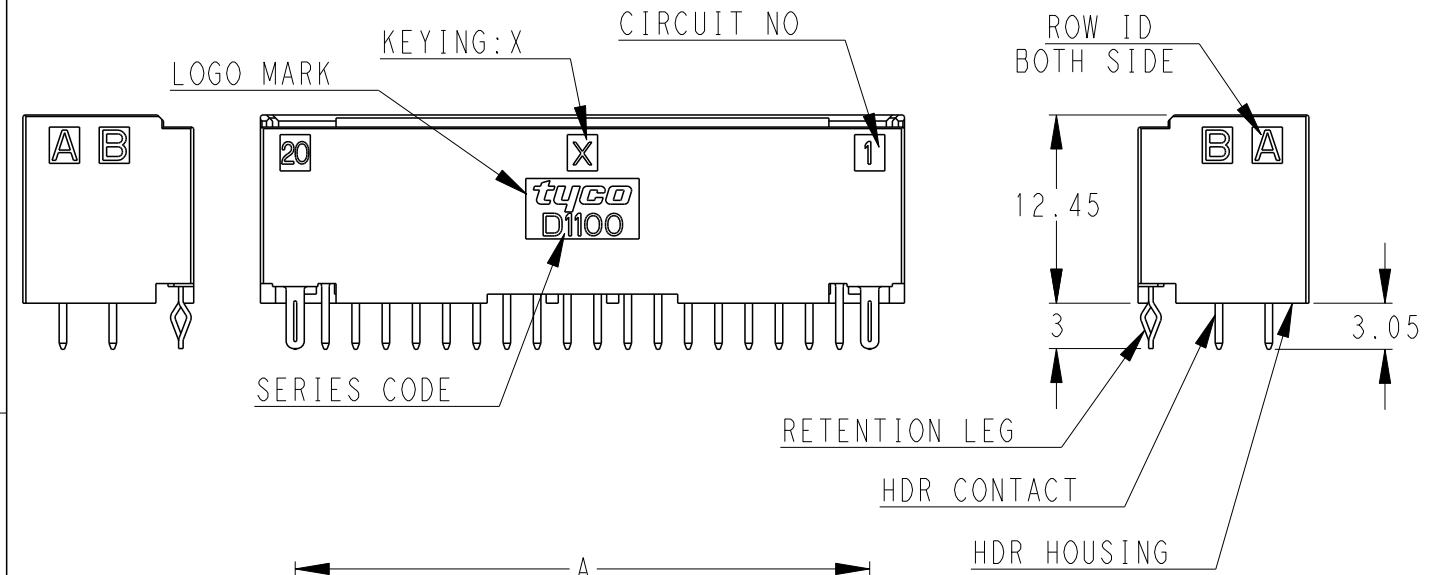

△ MATERIAL:
 HOUSING : GLASS FIBER THERMO PLASTIC
 POLYESTER(94V-0), COLOR: EXCLUDING BLACK
 CONTACT : PRE-TIN COPPER ALLOY
 RETENTION LEG : PRE-TIN COPPER ALLOY

POS	KEY	n	A	B	C	COLOR	PART NO
40	X	19	38.0	41.0	42.6	RED	5-1871056-0
40	X	19	38.0	41.0	42.6	YELLOW	3-1871056-0
40	X	19	38.0	41.0	42.6	NATURAL	1-1871056-0
32	X	15	30.0	33.0	34.6	NATURAL	1-1871056-6
30	X	14	28.0	31.0	32.6	YELLOW	3-1871056-5
30	X	14	28.0	31.0	32.6	NATURAL	1-1871056-5
28	X	13	26.0	29.0	30.6	RED	5-1871056-4
26	X	12	24.0	27.0	28.6	NATURAL	1-1871056-3
24	X	11	22.0	25.0	26.6	YELLOW	3-1871056-2
22	X	10	20.0	23.0	24.6	YELLOW	3-1871056-1

- 40POS(X-KEY):
 1-1871056-0(NATURAL)
 3-1871056-0(YELLOW)
 5-1871056-0(RED)

THIS DRAWING IS A CONTROLLED DOCUMENT.		DWN T.KUDO 21APR2005	STE TE Connectivity	
DIMENSIONS: mm		CHK D.MITSUGI 23AUG2005		
TOLERANCES UNLESS OTHERWISE SPECIFIED: ±0.3, ±5°		APVD D.MITSUGI 23AUG2005	NAME DYNAMIC 1100D 2.0mmPITCH HDR ASSY (V-TYPE) TIN PLATE-COLOR 22-40POS	
0-PLC ±		PRODUCT SPEC 108-78298	SIZE A3	
1-PLC ±0.5		APPLICATION SPEC 114-5377	CAGE CODE 00779	DRAWING NO C-1871056
2-PLC ±0.13		WEIGHT -	RESTRICTED TO -	
3-PLC ±0.013		CUSTOMER DRAWING		
4-PLC ±0.0001		SCALE 2:1		
ANGLES ±		SHEET 1 OF 3		
FINISH -		REV E		

LOC	DIST	REVISIONS			
P	LTR	DESCRIPTION	DATE	DWN	APVD
J	-	SEE SHEET 1 OF 3			

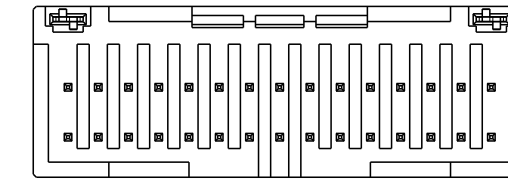
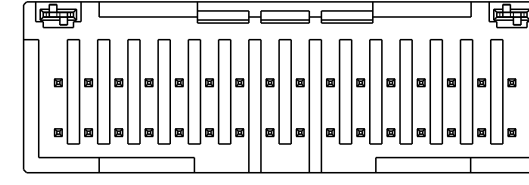
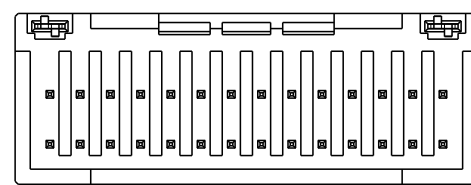
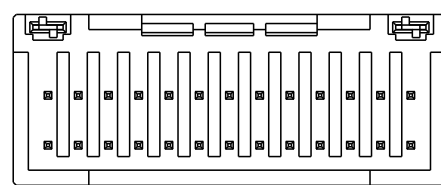
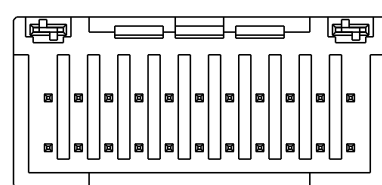
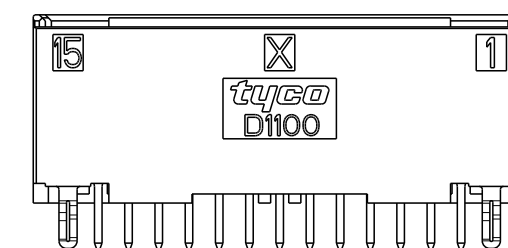
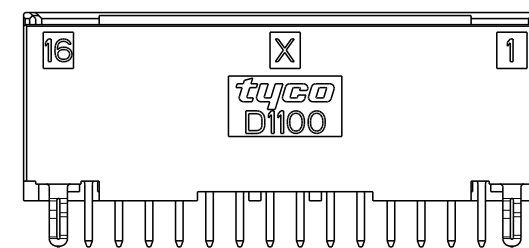
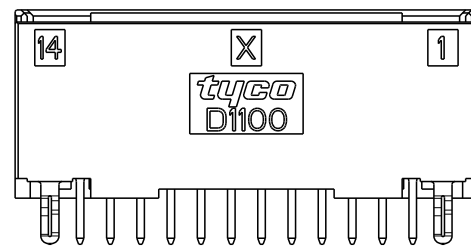
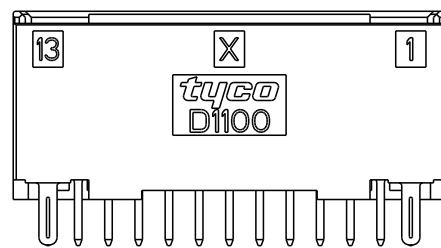
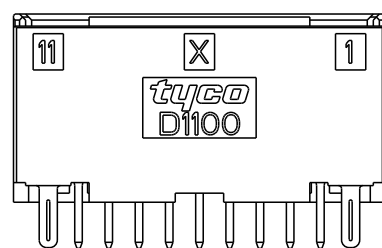
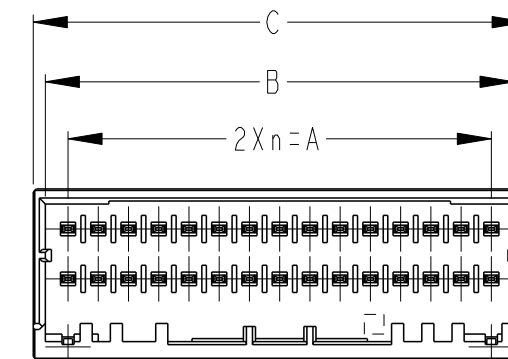
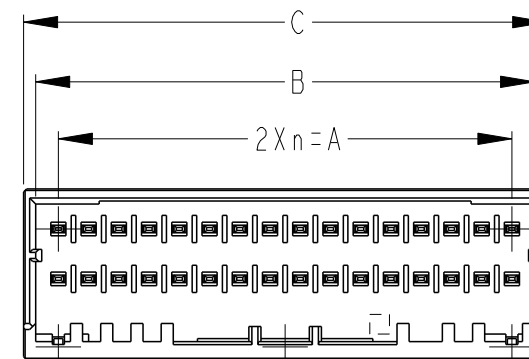
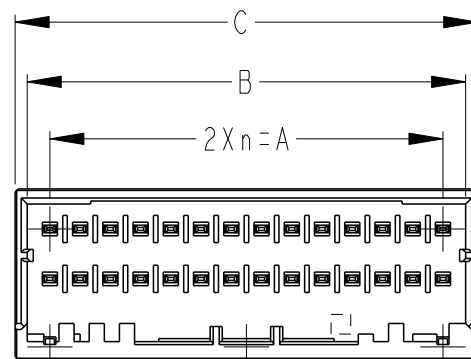
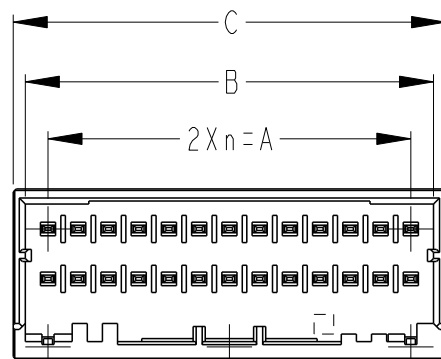
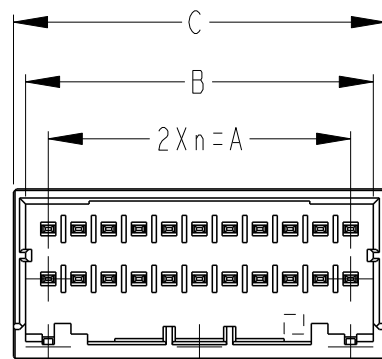

22POS(X-KEY):
3-1871056-1(YELLOW)

26POS(X-KEY):
1-1871056-3(NATURAL)

28POS(X-KEY):
5-1871056-4(RED)

32POS(X-KEY):
1-1871056-6(NATURAL)

30POS(X-KEY):
1-1871056-5(NATURAL)
3-1871056-5(YELLOW)

THIS DRAWING IS A CONTROLLED DOCUMENT.		DWN T. KUDO	21APR2005	TE Connectivity	
DIMENSIONS: mm		CHK D. MITSUGI	23AUG2005		
TOLERANCES UNLESS OTHERWISE SPECIFIED:		APVD D. MITSUGI	23AUG2005	NAME DYNAMIC 1100D 2.0mmPITCH HDR ASSY (V-TYPE) TIN PLATE-COLOR 22-40POS	
0 PLC ±		PRODUCT SPEC	108-78298	SIZE A3	CAGE CODE 00779
1 PLC ±		APPLICATION SPEC	114-5377	DRAWING NO C-1871056	RESTRICTED TO -
2 PLC ±		WEIGHT	-	SCALE 2:1	SHEET 2
3 PLC ±		CUSTOMER DRAWING		OF 3	REV E
4 PLC ±					
ANGLES ±					
MATERIAL					
FINISH					

SEE SHEET 1 OF 3

THIS DRAWING IS UNPUBLISHED.

RELEASED FOR PUBLICATION 20

© COPYRIGHT 20 BY Tyco Electronics Japan G.K. ALL RIGHTS RESERVED.

LOC	DIST	REVISIONS			
P	LTR	DESCRIPTION	DATE	DWN	APVD
		SEE SHEET 1 OF 3			

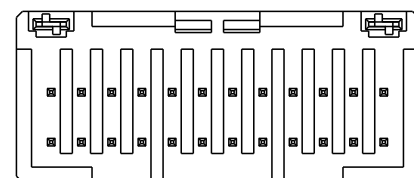
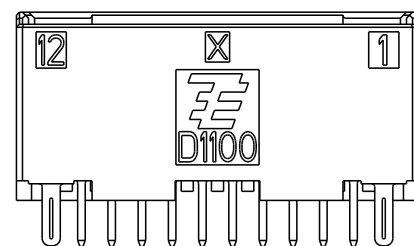
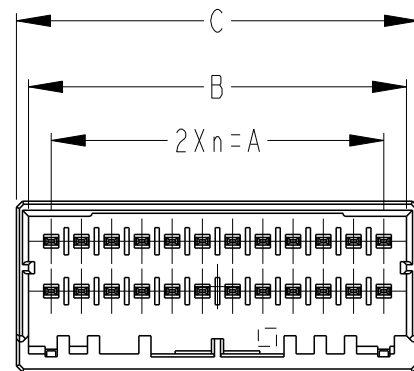

24POS(X-KEY):
3-1871056-2(YELLOW)

THIS DRAWING IS A CONTROLLED DOCUMENT.		DWN T. KUDO 21APR2005	 TE Connectivity	
DIMENSIONS: mm		CHK D. MITSUGI 23AUG2005		
TOLERANCES UNLESS OTHERWISE SPECIFIED:		APVD D. MITSUGI 23AUG2005	NAME DYNAMIC 1100D 2.0mmPITCH HDR ASSY (V-TYPE) TIN PLATE-COLOR 22-40POS	
0 PLC ± 1 PLC ± 2 PLC ± 3 PLC ± 4 PLC ± ANGLES ±		PRODUCT SPEC 108-78298	RESTRICTED TO	
MATERIAL -		APPLICATION SPEC 114-5377	SIZE A3	CAGE CODE 00779
FINISH -		WEIGHT -	DRAWING NO C=1871056	SCALE 2:1
		CUSTOMER DRAWING	SHEET 3	OF 3
			REV E	

SEE SHEET 1 OF 3