

Optocoupler, AC Input, 5300 V_{RMS}

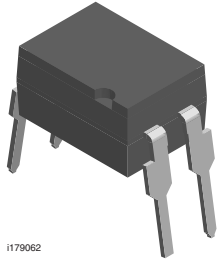

1179062

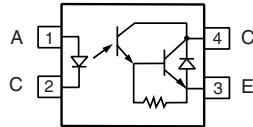

DESCRIPTION

The SFH620AA/SFH620AGB features a high current transfer ratio, low coupling capacitance and high isolation voltage. These couplers have a GaAs infrared emitting diode emitter, which is optically coupled to a silicon planar phototransistor detector, and is incorporated in a plastic DIP-4 package.

The coupling devices are designed for signal transmission between two electrically separated circuits.

The couplers are end-stackable with 2.54 mm lead spacing. Creepage and clearance distances of > 8.0 mm are achieved with option 6. This version complies with IEC 60950 (DIN VDE 0805) for reinforced insulation up to an operation voltage of 400 V_{RMS} or DC.

FEATURES

- High current transfer ratios
 - at 5 mA: 50 to 600 %
 - at 1.0 mA: 45 % typical (> 13)
- Low CTR degradation
- Good CTR linearity depending on forward current
- Isolation test voltage, 5300 V_{RMS}
- High collector emitter voltage, V_{CEO} = 70 V
- Low saturation voltage
- Fast switching times
- Temperature stable
- Low coupling capacitance
- End stackable, 0.100" (2.54 mm) spacing
- High common mode interference immunity (unconnected base)
- SMD option, see SFH620A/SFH6206 data sheet
- Lead (Pb)-free component
- Component in accordance to RoHS 2002/95/EC and WEEE 2002/96/EC



RoHS
COMPLIANT

AGENCY APPROVALS

- UL1577, file no. E52744 system code H or J, double protection
- DIN EN 60747-5-5 (VDE 0884) available with option 1
- CSA 93751
- BSI IEC 60950; IEC 60065

ORDER INFORMATION	
PART	REMARKS
SFH620AA	CTR 50 % to 600 %, DIP-4
SFH620AGB	CTR 100 % to 600 %, DIP-4
SFH620AA-X009	CTR 50 % to 600 %, SMD-4 (option 9)
SFH620AGB-X007	CTR 100 % to 600 %, SMD-4 (option 7)
SFH620AGB-X009	CTR 100 % to 600 %, SMD-4 (option 9)

Note

For additional information on the available options refer to option information.



ABSOLUTE MAXIMUM RATINGS ⁽¹⁾				
PARAMETER	TEST CONDITION	SYMBOL	VALUE	UNIT
INPUT				
Reverse voltage		V _R	6.0	V
DC forward current		I _F	± 60	mA
Surge forward current	t _p ≤ 1.0 μs	I _{FSM}	± 2.5	A
Total power dissipation		P _{diss}	100	mW
OUTPUT				
Collector emitter voltage		V _{CE}	70	V
Emitter collector voltage		V _{EC}	7	V
Collector current		I _C	50	mA
	t _p ≤ 1.0 ms	I _C	100	mA
Power dissipation		P _{diss}	150	mW
COUPLER				
Isolation test voltage between emitter and detector		V _{ISO}	5300	V _{RMS}
Creepage distance			≥ 7	mm
Clearance distance			≥ 7	mm
Insulation thickness between emitter and detector			0.4	mm
Comparative tracking index per DIN IEC 112/VDE 0303 part 1		CTI	175	
Isolation resistance	V _{IO} = 500 V, T _{amb} = 25 °C	R _{IO}	≥ 10 ¹²	Ω
	V _{IO} = 500 V, T _{amb} = 100 °C	R _{IO}	≥ 10 ¹¹	Ω
Storage temperature		T _{stg}	- 55 to + 150	°C
Ambient temperature		T _{amb}	- 55 to +100	°C
Junction temperature		T _j	100	°C
Soldering temperature ⁽²⁾	max. 10 s, dip soldering distance to seating plane ≥ 1.5 mm	T _{slid}	260	°C

Notes

- (1) T_{amb} = 25 °C, unless otherwise specified.
Stresses in excess of the absolute maximum ratings can cause permanent damage to the device. Functional operation of the device is not implied at these or any other conditions in excess of those given in the operational sections of this document. Exposure to absolute maximum ratings for extended periods of the time can adversely affect reliability.
- (2) Refer to reflow profile for soldering conditions for surface mounted devices (SMD). Refer to wave profile for soldering conditions for through hole devices (DIP).

ELECTRICAL CHARACTERISTICS							
PARAMETER	TEST CONDITION	PART	SYMBOL	MIN.	TYP.	MAX.	UNIT
INPUT							
Forward voltage	I _F = ± 60 mA		V _F		1.25	1.65	V
Capacitance	V _R = 0 V, f = 1 MHz		C _O		50		pF
Thermal resistance			R _{thja}		750		K/W
OUTPUT							
Collector emitter capacitance	V _{CE} = 5 V, f = 1 MHz		C _{CE}		6.8		pF
Thermal resistance			R _{thja}		500		K/W
COUPLER							
Collector emitter saturation voltage	I _F = 10 mA, I _C = 2.5 mA		V _{CEsat}		0.25	0.4	V
Coupling capacitance			C _C		0.2		pF
Collector emitter leakage current	V _{CE} = 10 V	SFH620AA	I _{CEO}		10	100	nA
		SFH620AGB	I _{CEO}		10	100	nA

Note

T_{amb} = 25 °C, unless otherwise specified.
Minimum and maximum values are testing requirements. Typical values are characteristics of the device and are the result of engineering evaluation. Typical values are for information only and are not part of the testing requirements.

CURRENT TRANSFER RATIO							
PARAMETER	TEST CONDITION	PART	SYMBOL	MIN.	TYP.	MAX.	UNIT
I _C /I _F	I _F = ± 5 mA, V _{CE} = 5 V	SFH620AA			50 to 600		%
		SFH620AGB			100 to 600		%

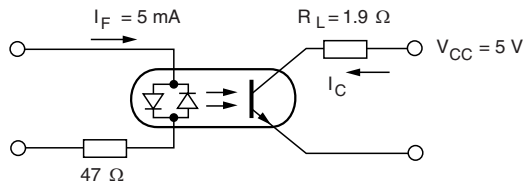

isfh620aa_0

Fig. 1 - Switching Times (Typical Values)
Linear Operation (Saturated)

SWITCHING CHARACTERISTICS						
PARAMETER	TEST CONDITION	SYMBOL	MIN.	TYP.	MAX.	UNIT
Turn-on time	I _F = 5 mA, R _L = 1.9 kΩ, V _{CC} = 5 V	t _{on}		2		μs
Turn-off time	I _F = 5 mA, R _L = 1.9 kΩ, V _{CC} = 5 V	t _{off}		25		μs

SAFETY AND INSULATION RATINGS						
PARAMETER	TEST CONDITION	SYMBOL	MIN.	TYP.	MAX.	UNIT
Climatic classification (according to IEC 68 part 1)				55/100/21		
Comparative tracking index		CTI	175		399	
V _{IOTM}			10000			V
V _{IORM}			890			V
P _{SO}					400	mW
I _{SI}					275	mA
T _{SI}					175	°C
Creepage distance	standard DIP-4		7			mm
Clearance distance	standard DIP-4		7			mm
Creepage distance	400 mil DIP-4		8			mm
Clearance distance	400 mil DIP-4		8			mm
Insulation thickness, reinforced rated	per IEC 60950 2.10.5.1		0.4			mm

Note

As per IEC 60747-5-2, § 7.4.3.8.1, this optocoupler is suitable for "safe electrical insulation" only within the safety ratings. Compliance with the safety ratings shall be ensured by means of protective circuits.

TYPICAL CHARACTERISTICS

T_{amb} = 25 °C, unless otherwise specified

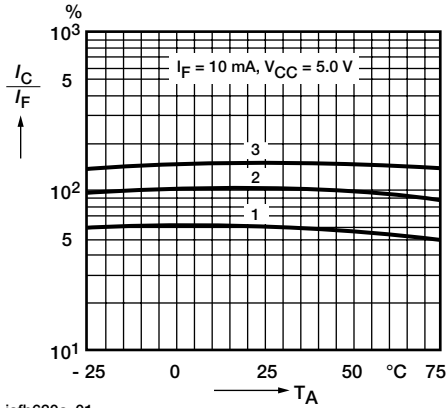

isfh620a_01

Fig. 2 - Current Transfer Ratio (CTR) vs. Temperature

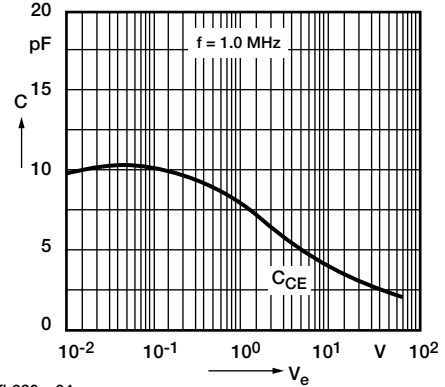

isfh620a_04

Fig. 5 - Transistor Capacitance (Typ.) vs. Collector Emitter Voltage

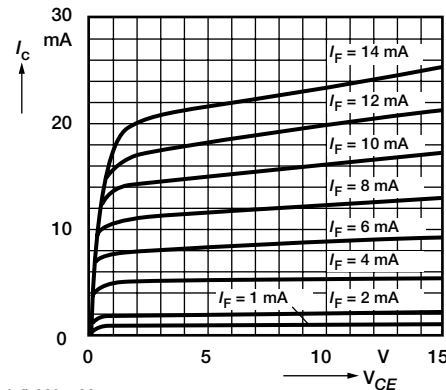

isfh620a_02

Fig. 3 - Output Characteristics (Typ.) Collector Current vs. Collector Emitter Voltage

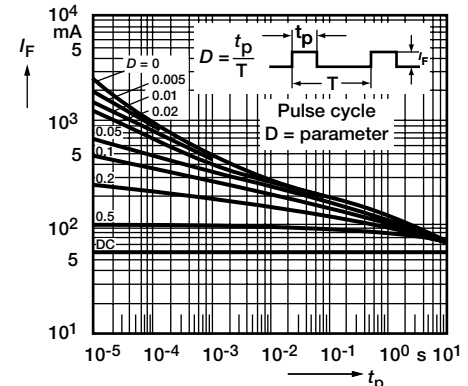

isfh620a_05

Fig. 6 - Permissible Pulse Handling Capability Forward Current vs. Pulse Width

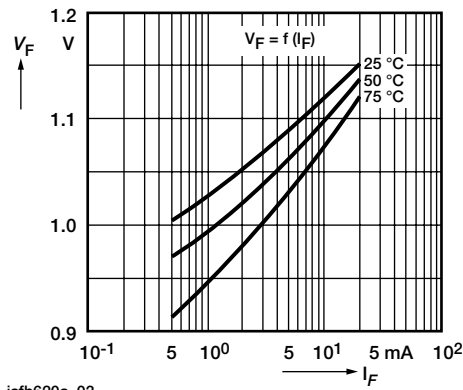

isfh620a_03

Fig. 4 - Diode Forward Voltage (Typ.) vs. Forward Current

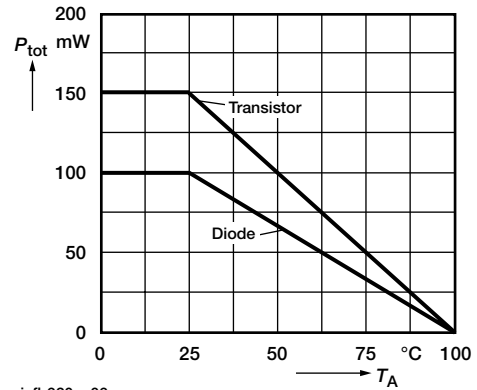

isfh620a_06

Fig. 7 - Permissible Power Dissipation vs. Ambient Temperature

SFH620AA, SFH620AGB

Vishay Semiconductors

Optocoupler, AC Input, 5300 V_{RMS}

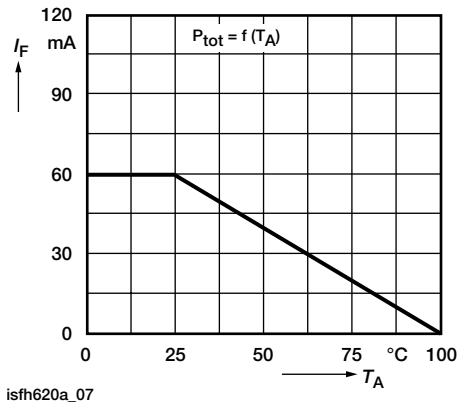
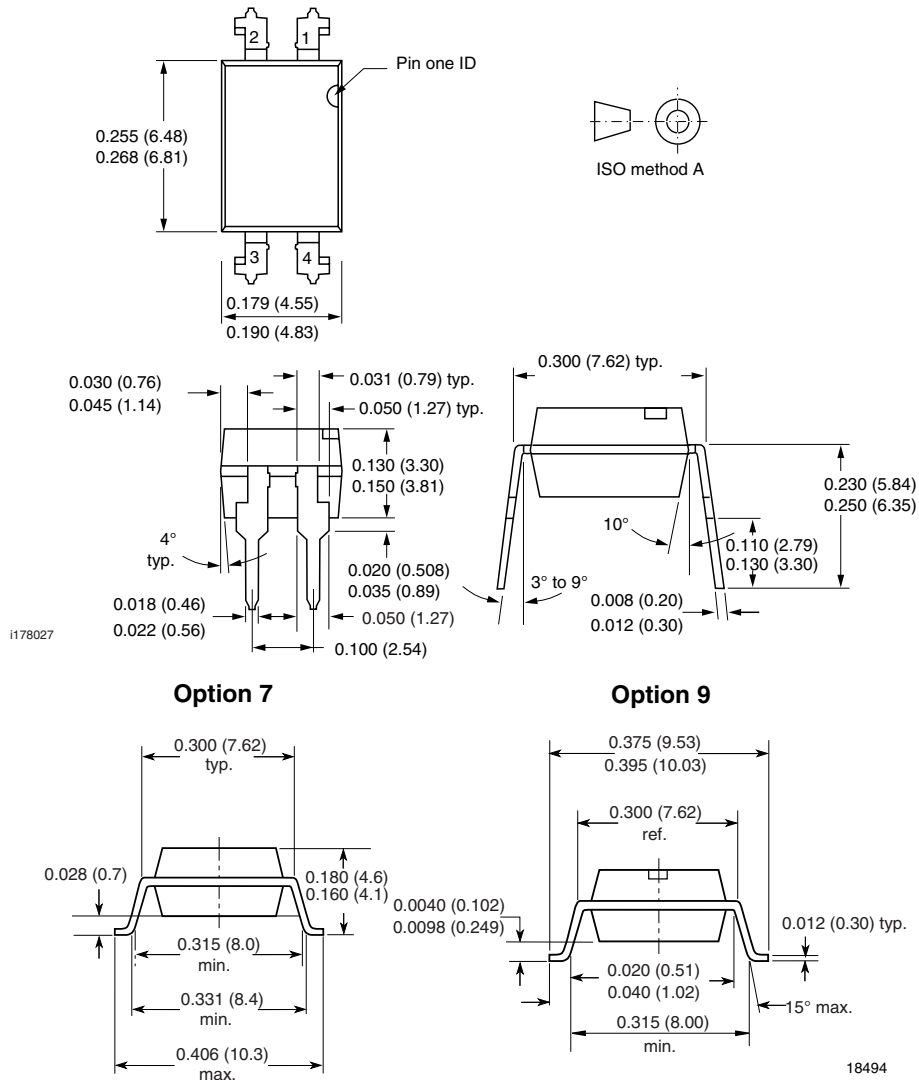

Fig. 8 - Permissible Diode Forward Current vs. Ambient Temperature

PACKAGE DIMENSIONS in inches (millimeters)



**OZONE DEPLETING SUBSTANCES POLICY STATEMENT**

It is the policy of Vishay Semiconductor GmbH to

1. Meet all present and future national and international statutory requirements.
2. Regularly and continuously improve the performance of our products, processes, distribution and operating systems with respect to their impact on the health and safety of our employees and the public, as well as their impact on the environment.

It is particular concern to control or eliminate releases of those substances into the atmosphere which are known as ozone depleting substances (ODSs).

The Montreal Protocol (1987) and its London Amendments (1990) intend to severely restrict the use of ODSs and forbid their use within the next ten years. Various national and international initiatives are pressing for an earlier ban on these substances.

Vishay Semiconductor GmbH has been able to use its policy of continuous improvements to eliminate the use of ODSs listed in the following documents.

1. Annex A, B and list of transitional substances of the Montreal Protocol and the London Amendments respectively.
2. Class I and II ozone depleting substances in the Clean Air Act Amendments of 1990 by the Environmental Protection Agency (EPA) in the USA.
3. Council Decision 88/540/EEC and 91/690/EEC Annex A, B and C (transitional substances) respectively.

Vishay Semiconductor GmbH can certify that our semiconductors are not manufactured with ozone depleting substances and do not contain such substances.

We reserve the right to make changes to improve technical design
and may do so without further notice.

Parameters can vary in different applications. All operating parameters must be validated for each customer application by the customer. Should the buyer use Vishay Semiconductors products for any unintended or unauthorized application, the buyer shall indemnify Vishay Semiconductors against all claims, costs, damages, and expenses, arising out of, directly or indirectly, any claim of personal damage, injury or death associated with such unintended or unauthorized use.

Vishay Semiconductor GmbH, P.O.B. 3535, D-74025 Heilbronn, Germany



Disclaimer

ALL PRODUCT, PRODUCT SPECIFICATIONS AND DATA ARE SUBJECT TO CHANGE WITHOUT NOTICE TO IMPROVE RELIABILITY, FUNCTION OR DESIGN OR OTHERWISE.

Vishay Intertechnology, Inc., its affiliates, agents, and employees, and all persons acting on its or their behalf (collectively, "Vishay"), disclaim any and all liability for any errors, inaccuracies or incompleteness contained in any datasheet or in any other disclosure relating to any product.

Vishay makes no warranty, representation or guarantee regarding the suitability of the products for any particular purpose or the continuing production of any product. To the maximum extent permitted by applicable law, Vishay disclaims (i) any and all liability arising out of the application or use of any product, (ii) any and all liability, including without limitation special, consequential or incidental damages, and (iii) any and all implied warranties, including warranties of fitness for particular purpose, non-infringement and merchantability.

Statements regarding the suitability of products for certain types of applications are based on Vishay's knowledge of typical requirements that are often placed on Vishay products in generic applications. Such statements are not binding statements about the suitability of products for a particular application. It is the customer's responsibility to validate that a particular product with the properties described in the product specification is suitable for use in a particular application. Parameters provided in datasheets and/or specifications may vary in different applications and performance may vary over time. All operating parameters, including typical parameters, must be validated for each customer application by the customer's technical experts. Product specifications do not expand or otherwise modify Vishay's terms and conditions of purchase, including but not limited to the warranty expressed therein.

Except as expressly indicated in writing, Vishay products are not designed for use in medical, life-saving, or life-sustaining applications or for any other application in which the failure of the Vishay product could result in personal injury or death. Customers using or selling Vishay products not expressly indicated for use in such applications do so at their own risk and agree to fully indemnify and hold Vishay and its distributors harmless from and against any and all claims, liabilities, expenses and damages arising or resulting in connection with such use or sale, including attorneys fees, even if such claim alleges that Vishay or its distributor was negligent regarding the design or manufacture of the part. Please contact authorized Vishay personnel to obtain written terms and conditions regarding products designed for such applications.

No license, express or implied, by estoppel or otherwise, to any intellectual property rights is granted by this document or by any conduct of Vishay. Product names and markings noted herein may be trademarks of their respective owners.